



US00D689837S

(12) **United States Design Patent**
Kangasmaa

(10) **Patent No.:** **US D689,837 S**

(45) **Date of Patent:** **** *Sep. 17, 2013**

(54) **HANDSET**

(75) Inventor: **Heikki Kangasmaa**, Espoo (FI)

(73) Assignee: **Nokia Corporation** (FI)

(*) Notice: This patent is subject to a terminal disclaimer.

(**) Term: **14 Years**

(21) Appl. No.: **29/413,795**

(22) Filed: **Feb. 21, 2012**

(51) **LOC (9) Cl.** **14-03**

(52) **U.S. Cl.**

USPC **D14/138 G; D14/138 C**

(58) **Field of Classification Search**

USPC D14/138 G, 138 AD, 341, 346, 138 R,
D14/138 AA, 138 AC, 138 C, 496, 203.1,
D14/203.4, 203.7, 248, 218; 455/575.1,
455/556.2, 575.3, 575.4; D21/517;
379/433.01, 433.04; D10/65, 78, 104;
D13/168

See application file for complete search history.

(56) **References Cited**

U.S. PATENT DOCUMENTS

D578,503 S	*	10/2008	Shin et al.	D14/138 AD
D585,411 S		1/2009	Eaton		
D594,836 S	*	6/2009	Harju	D14/138 AD
D597,537 S		8/2009	Eaton		
D602,463 S	*	10/2009	Eguchi	D14/138 G
D605,623 S	*	12/2009	Aarras	D14/138 AD
D606,038 S		12/2009	Aarras		
D617,755 S		6/2010	Leinvuo		
D618,655 S		6/2010	Sandberg		
D619,983 S	*	7/2010	Fujimura et al.	D14/138 G
D620,467 S	*	7/2010	Aarras	D14/138 G
D625,700 S		10/2010	Sandberg et al.		
D629,376 S		12/2010	Choi et al.		
D629,377 S		12/2010	Ivaskevicius		

D629,772 S	*	12/2010	Mo et al.	D14/138 G
D629,784 S		12/2010	Forsyth		
D633,888 S		3/2011	Eguchi		
D634,290 S		3/2011	Landwehr		
D634,294 S		3/2011	Dhondt		
D635,954 S		4/2011	Aarras		
D635,967 S		4/2011	Montin et al.		
D636,364 S		4/2011	Sandberg		
D637,576 S	*	5/2011	Lee	D14/138 AD
D637,992 S		5/2011	Tom et al.		
D639,770 S		6/2011	Choi		
D640,222 S		6/2011	Dearsley		
D640,225 S		6/2011	Choi		

(Continued)

OTHER PUBLICATIONS

Nokia 808 PureView telephone, announced Feb. 2012, [online], [site visited Nov. 21, 2012]. Available from Internet, <URL: http://www.gsmarena.com/nokia_808_pureview-4577.php>.*

(Continued)

Primary Examiner — Jeffrey D Asch

(74) *Attorney, Agent, or Firm* — Banner & Witcoff, Ltd.

(57) **CLAIM**

The ornamental design for a handset, as shown and described.

DESCRIPTION

FIG. 1 is a perspective view of a handset showing my new design;

FIG. 2 is a front view thereof;

FIG. 3 is a rear view thereof;

FIG. 4 is a left side view thereof;

FIG. 5 is a right side view thereof;

FIG. 6 is a top view thereof; and,

FIG. 7 is a bottom view thereof.

The broken lines of the handset and the unshaded regions therein are for illustrative purposes only and form no part of the claimed design.

1 Claim, 5 Drawing Sheets

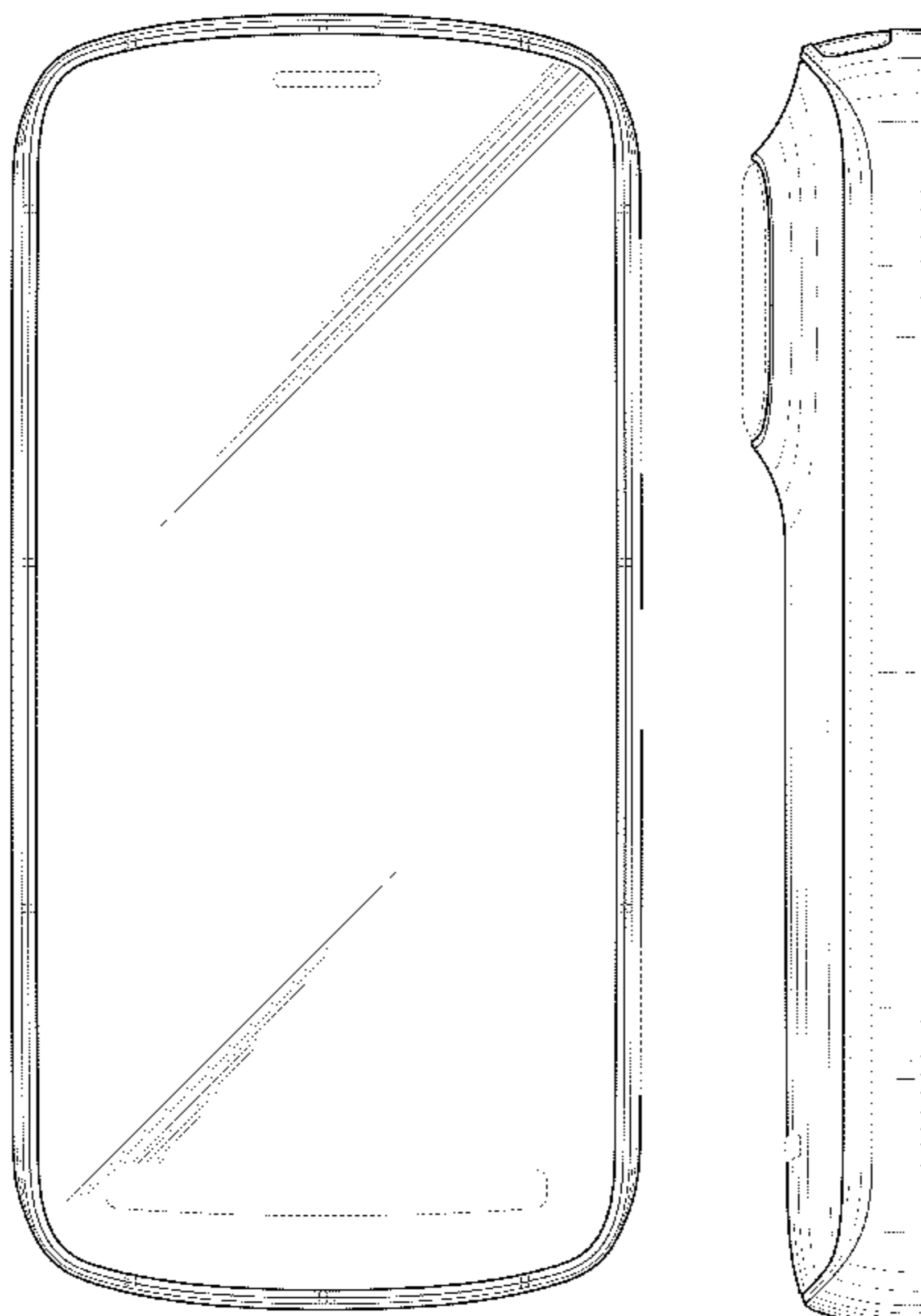

(56)

References Cited

U.S. PATENT DOCUMENTS

D644,196 S * 8/2011 Lee et al. D14/138 AD
 D645,442 S 9/2011 Landwehr
 D646,248 S * 10/2011 Lee D14/138 G
 D647,499 S * 10/2011 Page et al. D14/138 AD
 D648,712 S 11/2011 Brickstad
 D650,347 S 12/2011 Wong
 D650,349 S 12/2011 Tom et al.
 D650,350 S 12/2011 Wong
 D651,998 S 1/2012 Marsh
 D652,000 S 1/2012 Liu
 D652,001 S 1/2012 Yang
 D652,003 S * 1/2012 Park et al. D14/138 G
 D652,403 S 1/2012 Fahlgren et al.
 D652,815 S 1/2012 Wong
 D653,246 S 1/2012 Salazar et al.
 D654,036 S 2/2012 Wozniak
 D654,459 S * 2/2012 Kim D14/138 AD
 D654,905 S 2/2012 Forsyth
 D655,698 S 3/2012 Forsyth
 D656,917 S 4/2012 Tom et al.
 D657,764 S * 4/2012 Hong D14/138 G
 D658,620 S 5/2012 Lylyk
 D658,621 S 5/2012 Lylyk
 D663,710 S * 7/2012 Park D14/138 G
 D665,761 S * 8/2012 Russo D14/138 G
 D665,764 S * 8/2012 Shi et al. D14/138 G
 D666,570 S * 9/2012 Kim et al. D14/138 G
 D670,262 S * 11/2012 Mitchell et al. D14/138 G

OTHER PUBLICATIONS

Nokia 603 telephone, announced Oct. 2011, [online], [site visited Nov. 21, 2012]. Available from Internet, <URL: http://www.gsmarena.com/nokia_603-4243.php>.*
 Nokia C7 telephone, announced Sep. 2010, [online], [site visited Nov. 21, 2012]. Available from Internet, <URL: http://www.gsmarena.com/nokia_c7-3394.php>.*

Motorola MOTO XT882 telephone, announced May 2011, [online], [site visited Nov. 21, 2012]. Available from Internet, <URL: http://www.gsmarena.com/motorola_moto_xt882-3981.php>.*
 ZTE N290 telephone, announced 2010, [online], [site visited Nov. 21, 2012]. Available from Internet, <URL: http://www.gsmarena.com/zte_n290-3602.php>.*
 LG Optimus True HD LTE P936 telephone, announced Apr. 2012, [online], [site visited Nov. 21, 2012]. Available from Internet, <URL: http://www.gsmarena.com/lg_optimus_true_hd_lte_p936-4717.php>.*
 Nokia N9 by Nokia Corporation, 1 full page of color photograph, disclosed on or about Jun. 2011.
 Nokia Lumia 800 by Nokia Corporation, 1 full page of color photograph, disclosed on or about Oct. 2011.
 Nokia N8 by Nokia Corporation, 1 full page of color photograph, disclosed on or about Apr. 2011.
 Nokia 700 by Nokia Corporation, 1 full page of color photograph, disclosed on or about Aug. 2011.
 Nokia C5-03 by Nokia Corporation, 1 full page of color photograph, disclosed on or about Oct. 2010.
 Nokia 500 by Nokia Corporation, 1 full page of color photograph, disclosed on or about Aug. 2011.
 Nokia E7 by Nokia Corporation, 1 full page of color photograph, disclosed on or about Sep. 2010.
 Nokia N900 by Nokia Corporation, 1 full page of color photograph, disclosed on or about Aug. 2009.
 Nokia C6-01 by Nokia Corporation, 1 full page of color photograph, disclosed on or about Sep. 2010.
 Nokia X6 by Nokia Corporation, 1 full page of color photograph, disclosed on or about Sep. 2009.
 Nokia 603 by Nokia Corporation, 1 full page of color photograph, disclosed on or about Oct. 2011.
 Nokia C5-06 by Nokia Corporation, 1 full page of color photograph, disclosed on or about Oct. 2011.
 Nokia 5250 by Nokia Corporation, 1 full page of color photograph, disclosed on or about Aug. 2010.
 Nokia N950 by Nokia Corporation, 1 full page of color photograph, disclosed on or about Jun. 2011.

* cited by examiner

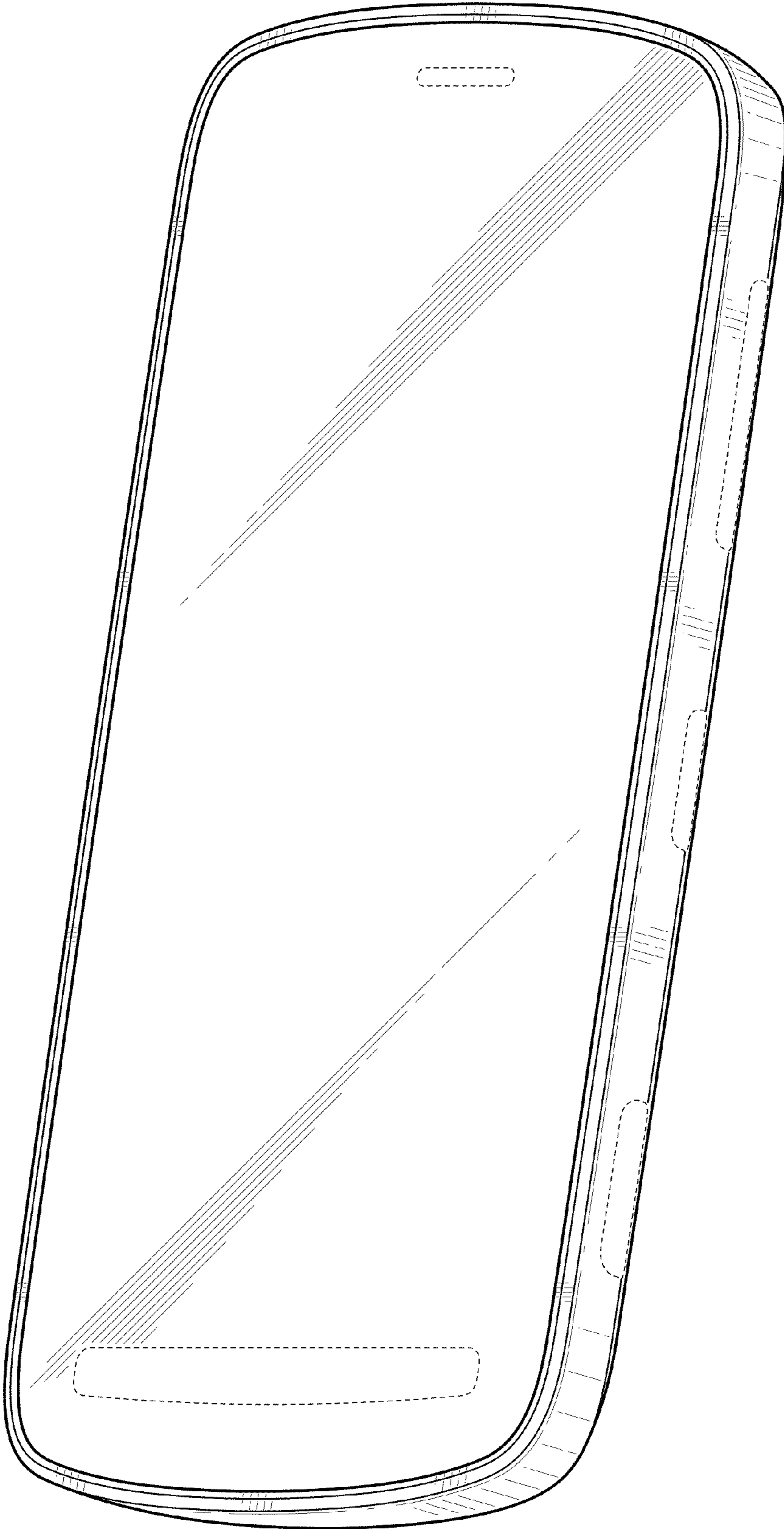

FIG. 1

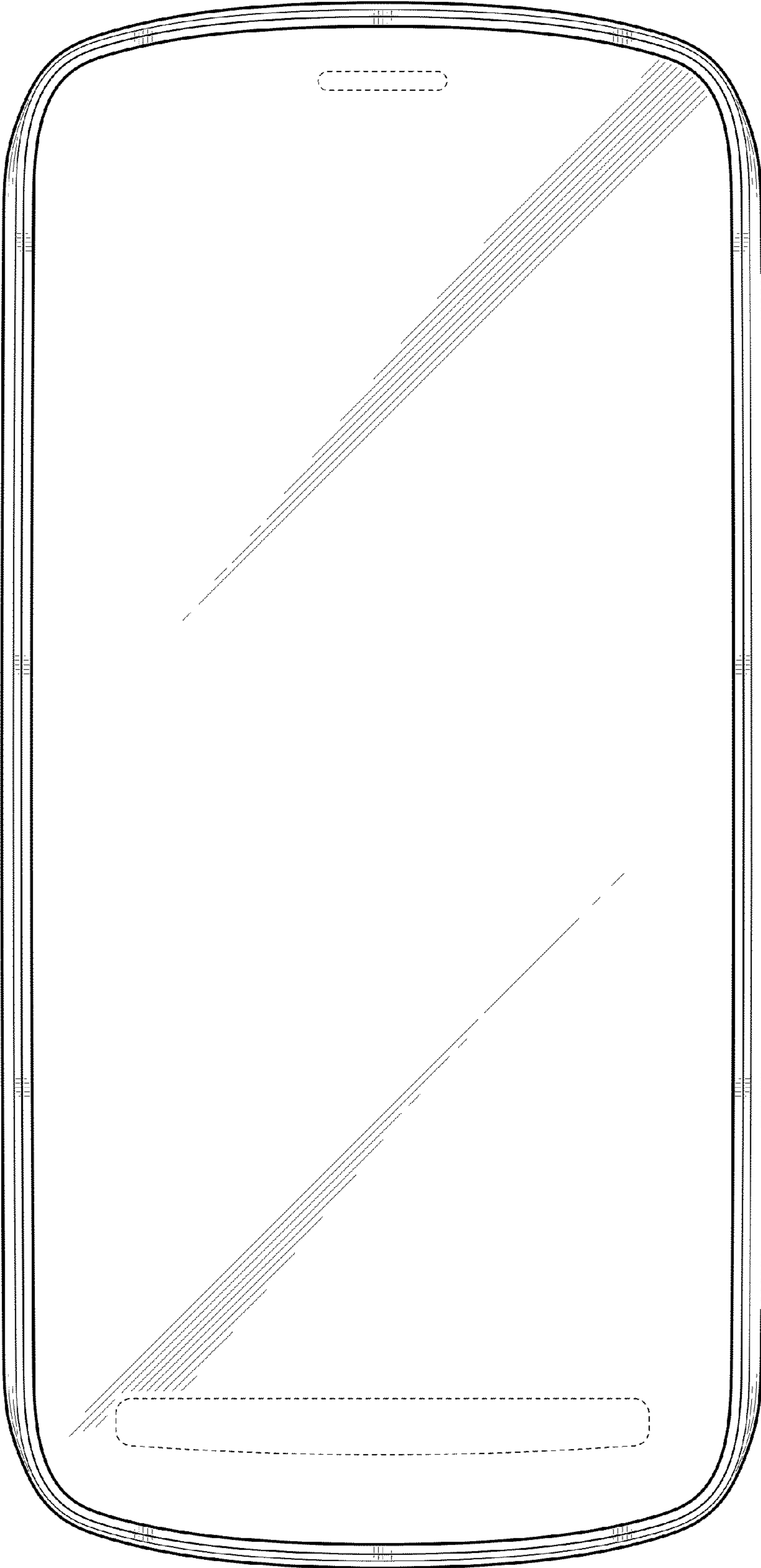

FIG. 2

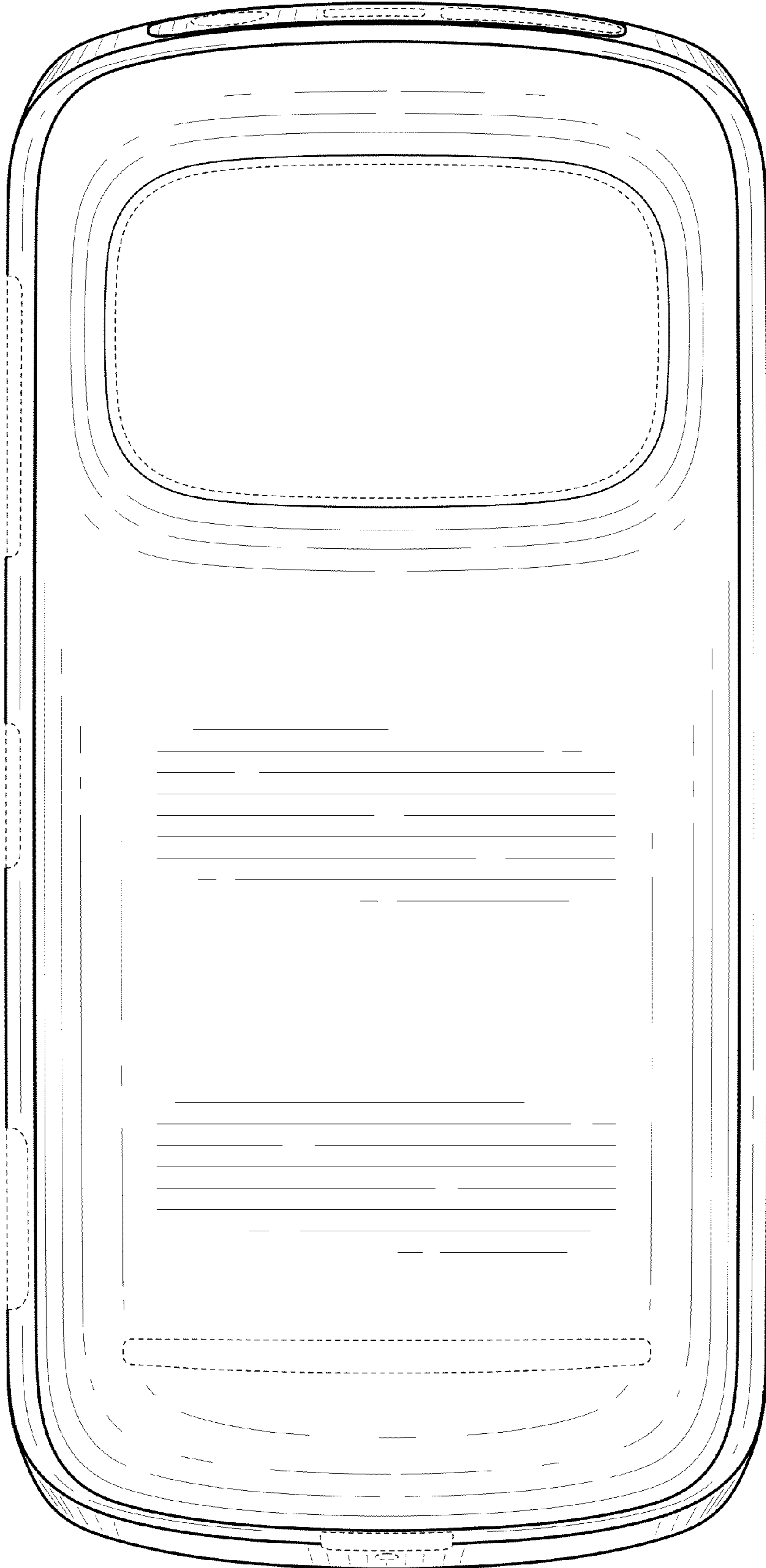

FIG. 3

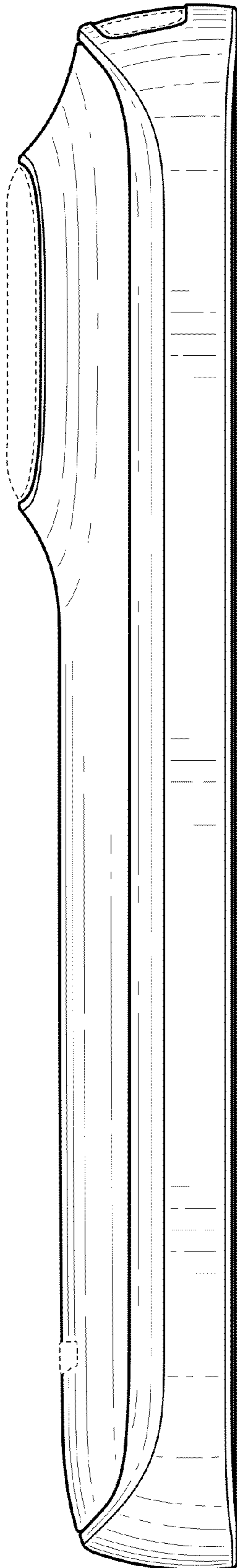

FIG. 4

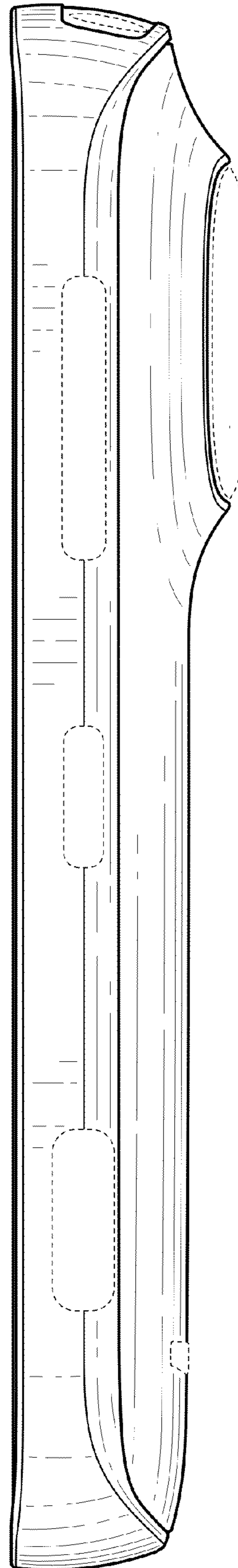

FIG. 5

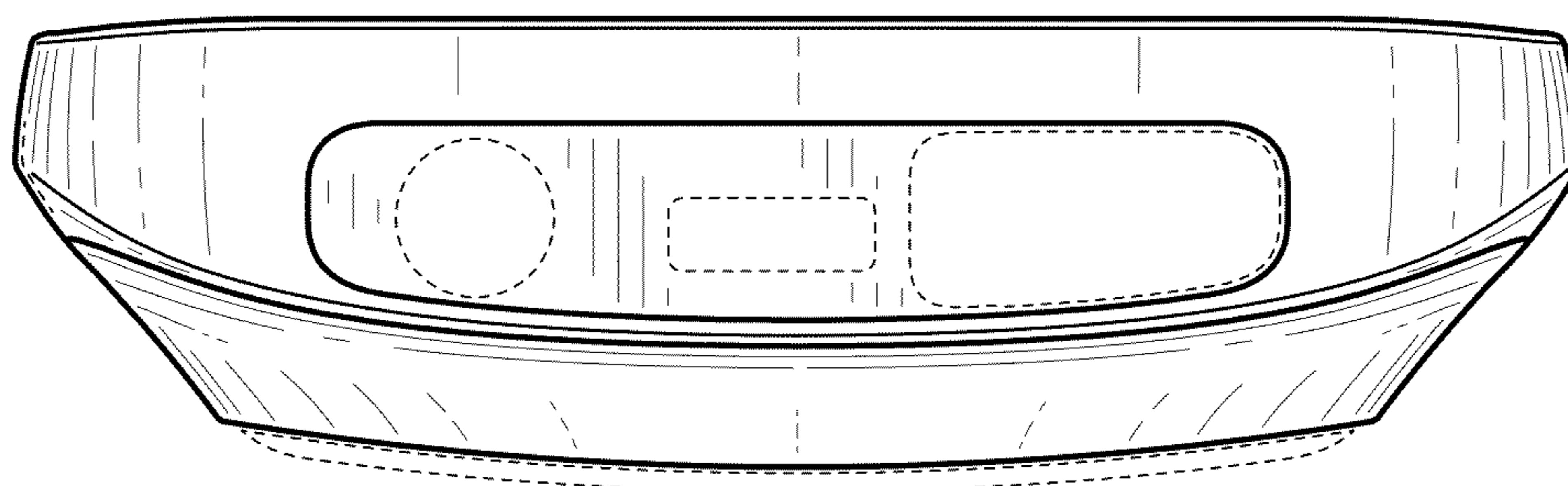

FIG. 6

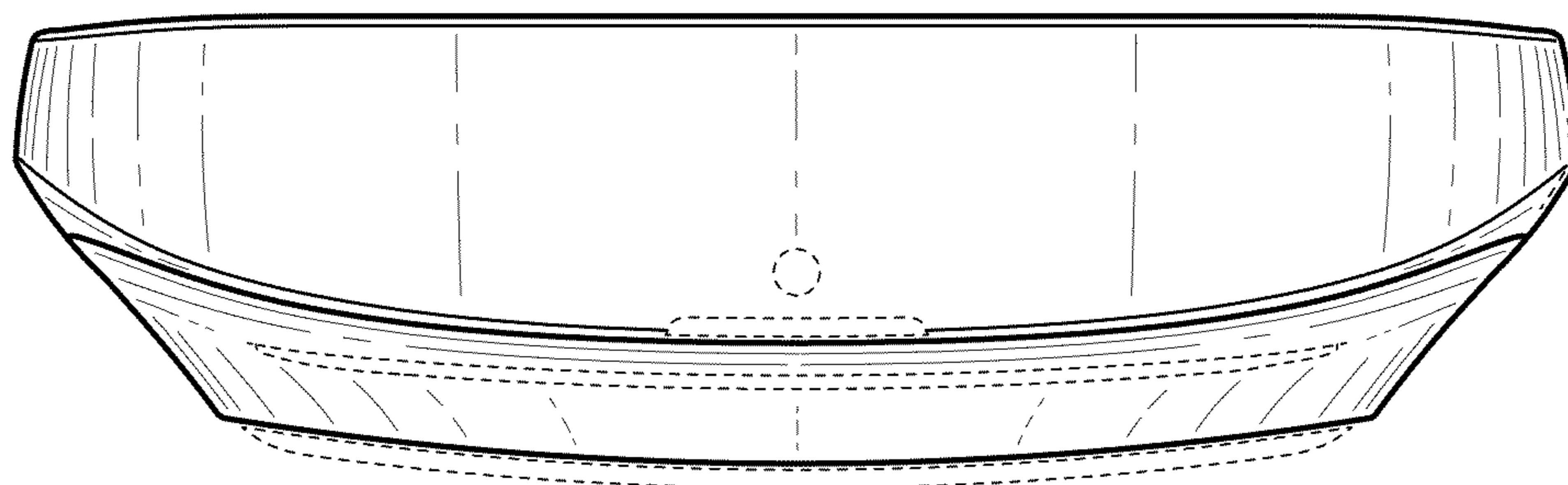

FIG. 7