



US00D689799S

(12) **United States Design Patent**
Ruggiero

(10) **Patent No.:** **US D689,799 S**
(45) **Date of Patent:** **** Sep. 17, 2013**

(54) **MULTIPLE VEHICLE STAND**

(71) Applicant: **Richard E Ruggiero**, Manassas, VA
(US)

(72) Inventor: **Richard E Ruggiero**, Manassas, VA
(US)

(**) Term: **14 Years**

(21) Appl. No.: **29/445,519**

(22) Filed: **Feb. 13, 2013**

(51) **LOC (9) Cl.** **12-11**

(52) **U.S. Cl.**
USPC **D12/115**

(58) **Field of Classification Search**
USPC D12/115, 120; 211/5, 17-24, 127,
211/146, 309.1; 248/175, 176.1; 280/293
See application file for complete search history.

(56) **References Cited**

U.S. PATENT DOCUMENTS

5,036,987	A *	8/1991	Smiedt	211/22
5,996,814	A *	12/1999	Workman et al.	211/22
6,164,459	A *	12/2000	Liem	211/5
D604,207	S *	11/2009	Selzer et al.	D12/115
D612,301	S *	3/2010	Porter et al.	D12/115
D617,238	S *	6/2010	Ohlman et al.	D12/115
D620,845	S *	8/2010	Scholtz et al.	D12/115
D621,751	S *	8/2010	Rost, Jr.	D12/115

* cited by examiner

Primary Examiner — Susan M Lee
Assistant Examiner — Linda Brooks

(57) **CLAIM**

The ornamental design for a multiple vehicle stand, as shown and described.

DESCRIPTION

FIG. 1 is a front perspective view showing a first embodiment of my new design;

FIG. 2 is a left side elevation thereof, the right side being a mirror image;

FIG. 3 is a front elevation thereof;

FIG. 4 is a rear elevation thereof;

FIG. 5 is a front perspective view showing a second embodiment of my new design;

FIG. 6 is a left side elevation thereof, the right side being a mirror image;

FIG. 7 is a front elevation thereof;

FIG. 8 is a rear elevation thereof;

FIG. 9 is a front perspective view showing a third embodiment of my new design;

FIG. 10 is a left side elevation thereof, the right side being a mirror image;

FIG. 11 is a front elevation thereof;

FIG. 12 is a rear elevation thereof;

FIG. 13 is a front perspective view showing a fourth embodiment of my new design;

FIG. 14 is a left side elevation thereof, the right side being a mirror image;

FIG. 15 is a front elevation thereof;

FIG. 16 is a rear elevation thereof;

FIG. 17 is a front perspective view showing a fifth embodiment of my new design;

FIG. 18 is a left side elevation thereof, the right side being a mirror image;

FIG. 19 is a front elevation thereof;

FIG. 20 is a rear elevation thereof;

FIG. 21 is a front perspective view showing a sixth embodiment of my new design;

FIG. 22 is a left side elevation thereof, the right side being a mirror image;

FIG. 23 is a front elevation thereof;

FIG. 24 is a rear elevation thereof;

FIG. 25 is a front perspective view showing a seventh embodiment of my new design;

FIG. 26 is a left side elevation thereof, the right side being a mirror image;

FIG. 27 is a front elevation thereof;

FIG. 28 is a rear elevation thereof;

FIG. 29 is a front perspective view showing a eighth embodiment of my new design;

FIG. 30 is a left side elevation thereof, the right side being a mirror image;

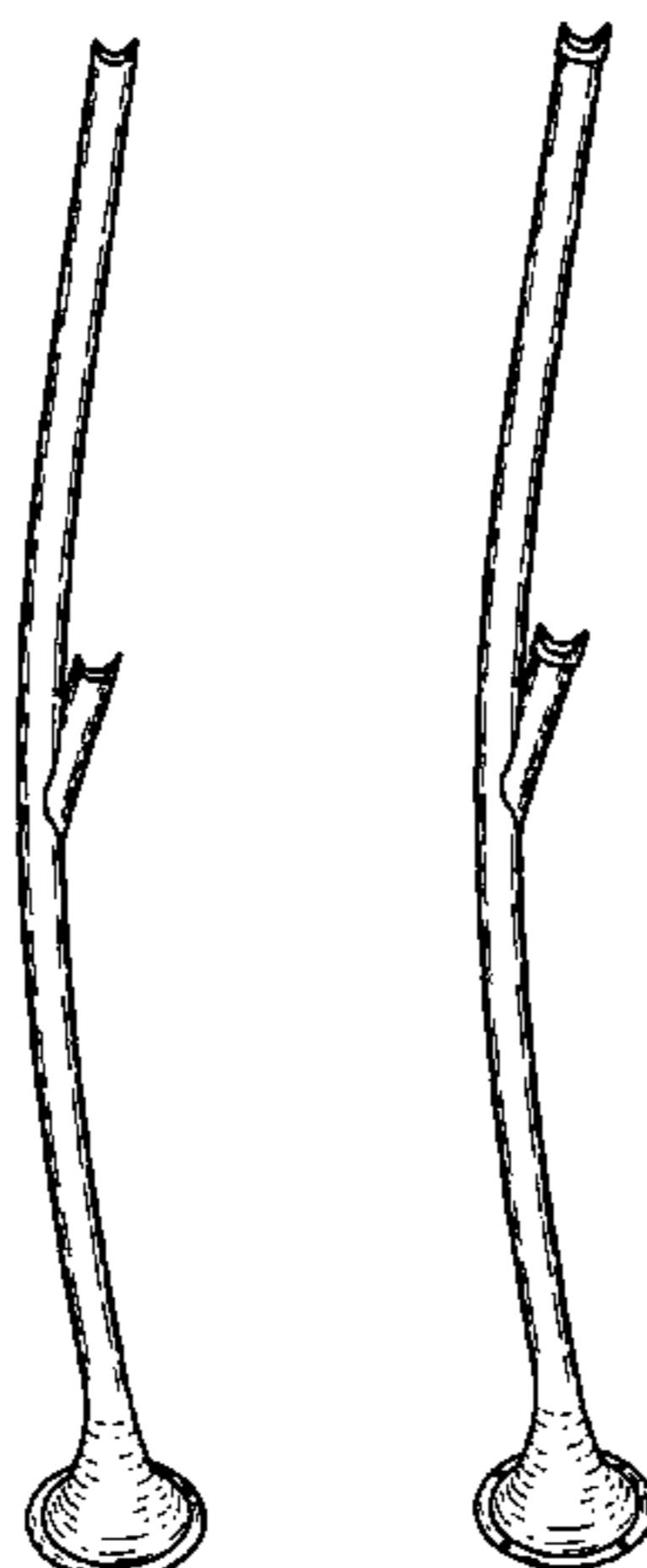

FIG. 31 is a front elevation thereof;
FIG. 32 is a rear elevation thereof;
FIG. 33 is a front perspective view showing a ninth embodiment of my new design;
FIG. 34 is a left side elevation thereof, the right side being a mirror image;
FIG. 35 is a front elevation thereof;
FIG. 36 is a rear elevation thereof;
FIG. 37 is a front perspective view showing a tenth embodiment of my new design;
FIG. 38 is a left side elevation thereof, the right side being a mirror image;
FIG. 39 is a front elevation thereof;
FIG. 40 is a rear elevation thereof;
FIG. 41 is a front perspective view showing a eleventh embodiment of my new design;
FIG. 42 is a left side elevation thereof, the right side being a mirror image;
FIG. 43 is a front elevation thereof;
FIG. 44 is a rear elevation thereof;
FIG. 45 is a front perspective view showing a twelfth embodiment of my new design;
FIG. 46 is a left side elevation thereof, the right side being a mirror image;
FIG. 47 is a front elevation thereof;
FIG. 48 is a rear elevation thereof;

FIG. 49 is a front perspective view showing a thirteenth embodiment of my new design;
FIG. 50 is a left side elevation thereof, the right side being a mirror image;
FIG. 51 is a front elevation thereof;
FIG. 52 is a rear elevation thereof;
FIG. 53 is a front perspective view showing a fourteenth embodiment of my new design;
FIG. 54 is a left side elevation thereof, the right side being a mirror image;
FIG. 55 is a front elevation thereof;
FIG. 56 is a rear elevation thereof;
FIG. 57 is a front perspective view showing a fifteenth embodiment of my new design;
FIG. 58 is a left side elevation thereof, the right side being a mirror image;
FIG. 59 is a front elevation thereof;
FIG. 60 is a rear elevation thereof;
FIG. 61 is a front perspective view showing a sixteenth embodiment of my new design;
FIG. 62 is a left side elevation thereof, the right side being a mirror image;
FIG. 63 is a front elevation thereof; and,
FIG. 64 is a rear elevation thereof.

1 Claim, 16 Drawing Sheets

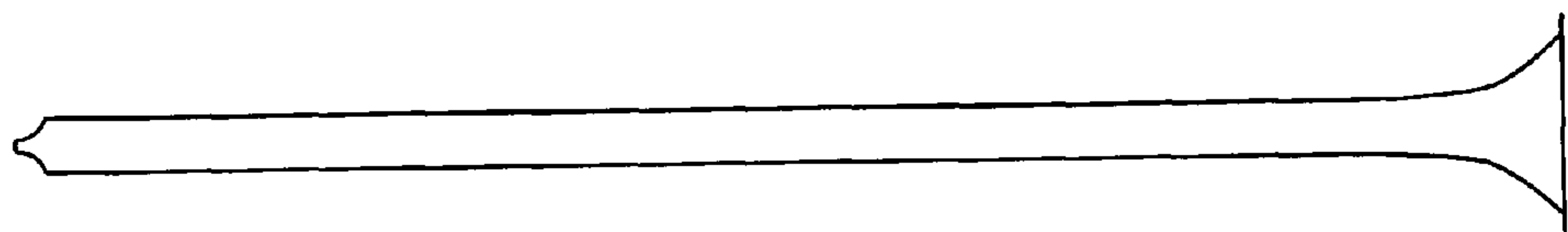

Fig. 4

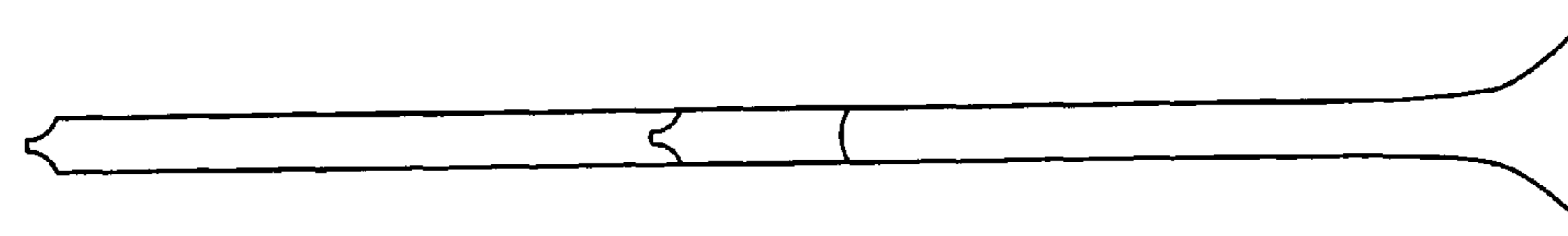

Fig. 3

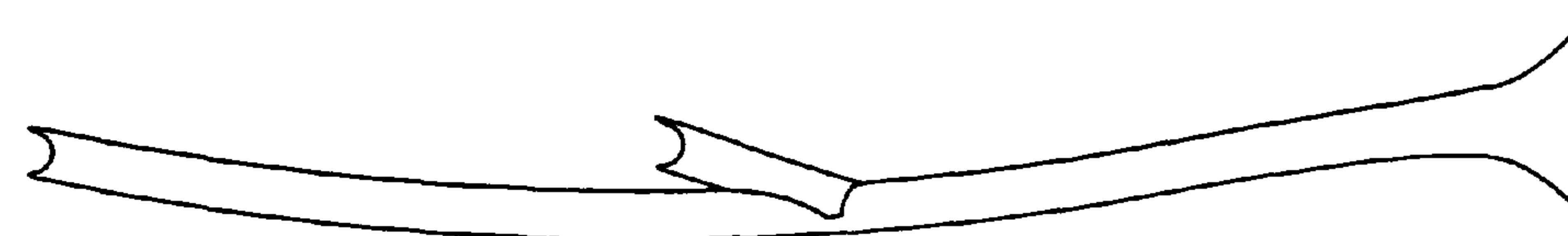

Fig. 2



Fig. 1



Fig. 5

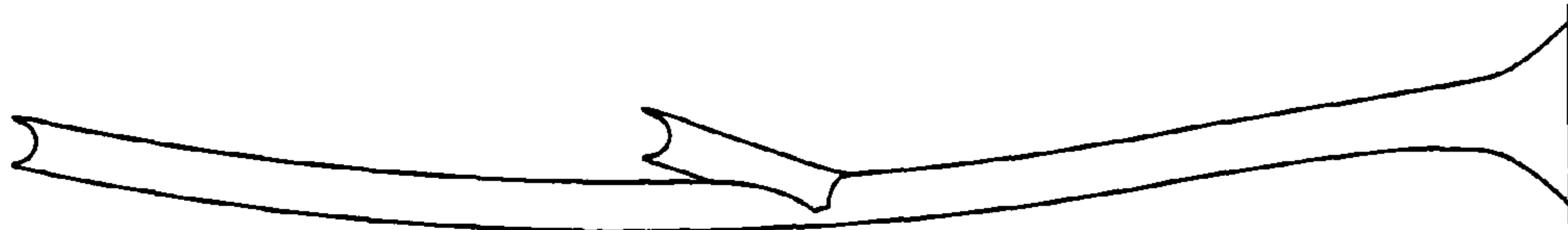

Fig. 6

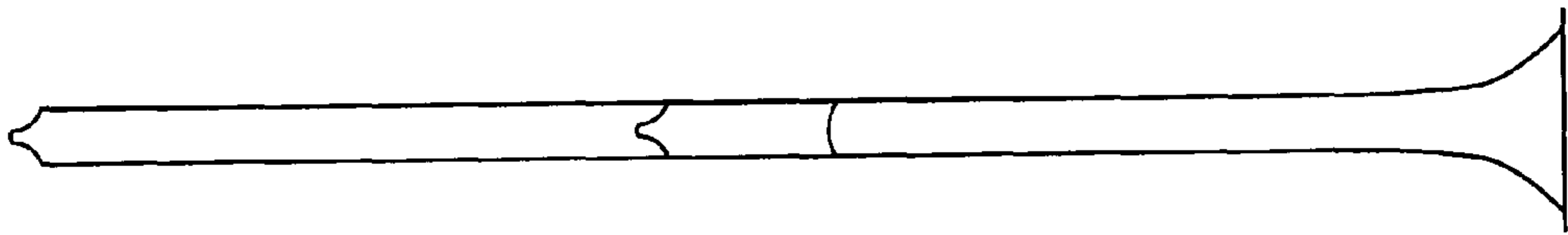

Fig. 7

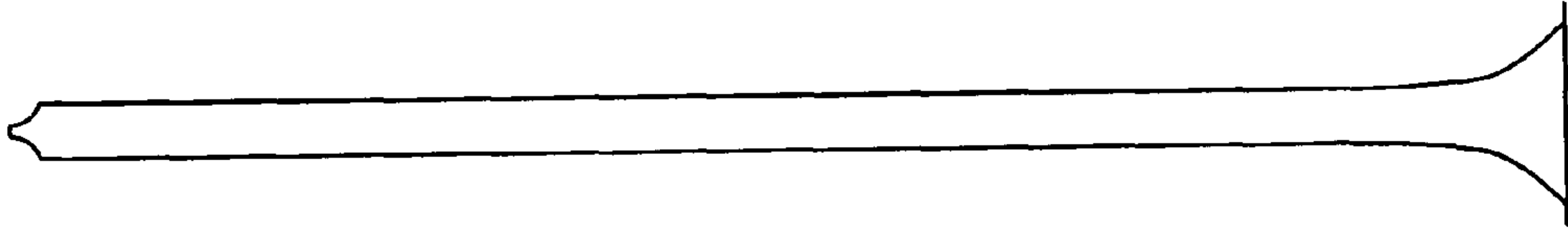

Fig. 8

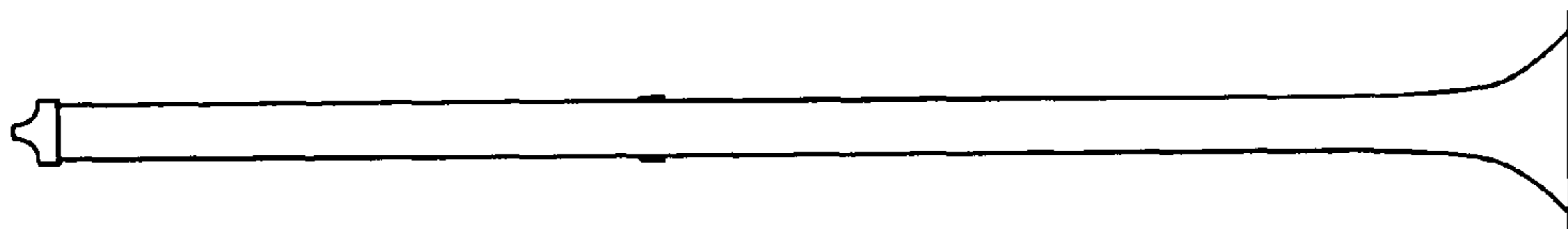

Fig. 12

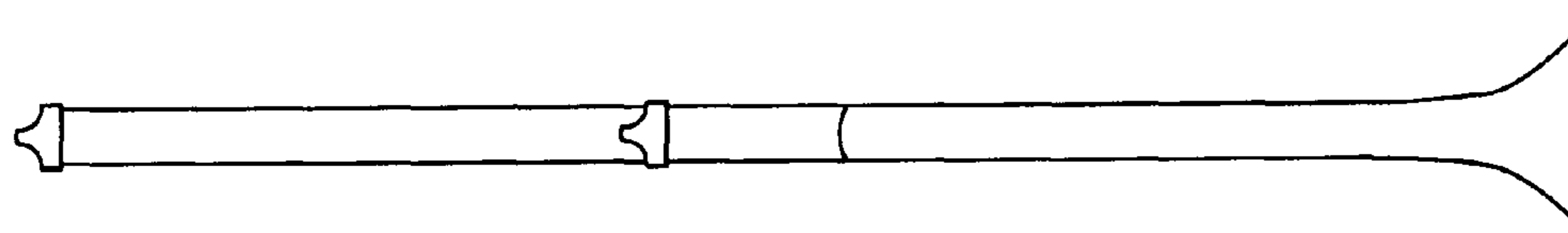

Fig. 11

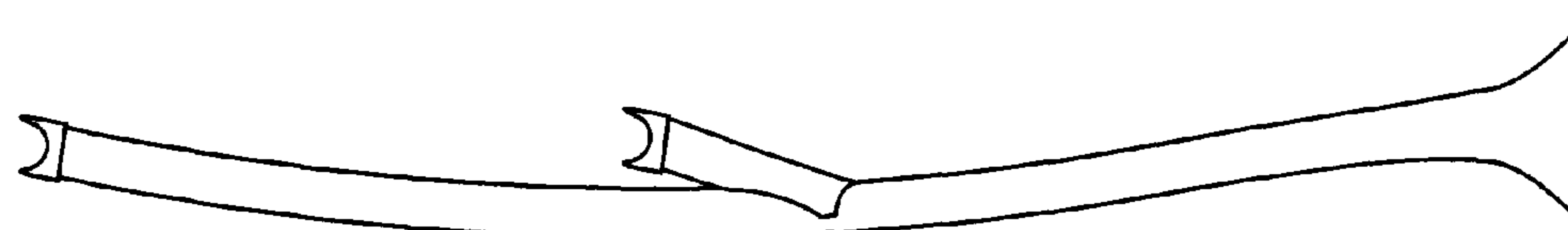

Fig. 10



Fig. 9



Fig. 13

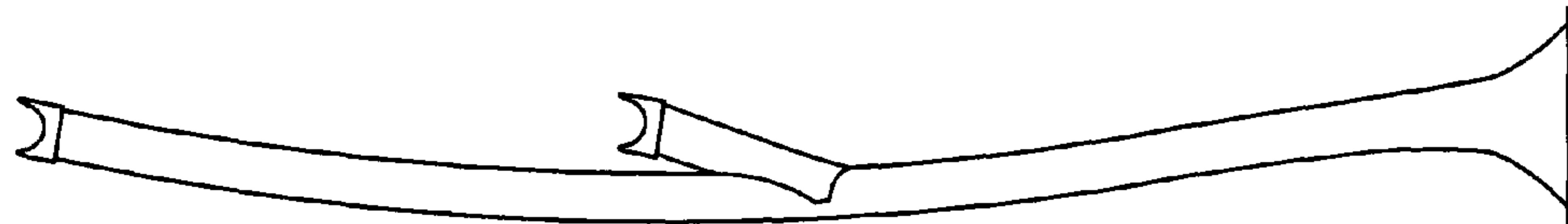

Fig. 14

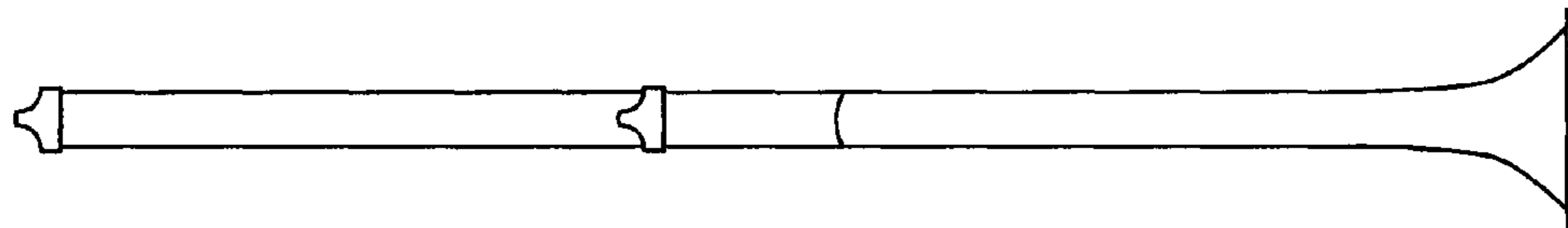

Fig. 15



Fig. 16



Fig. 17

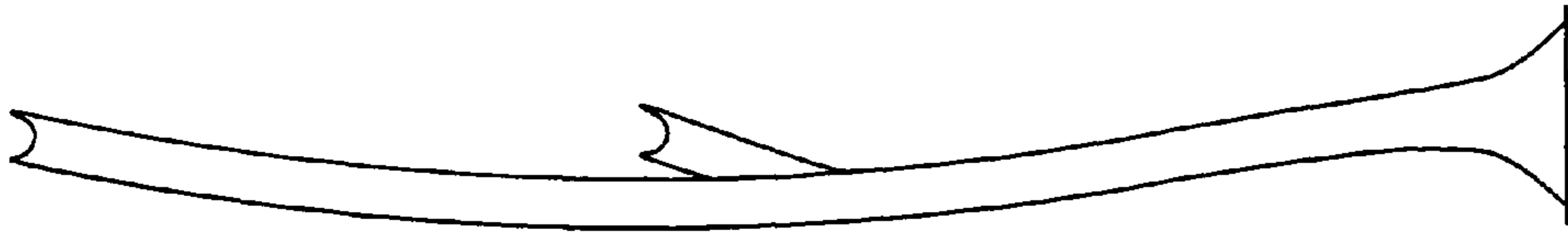

Fig. 18

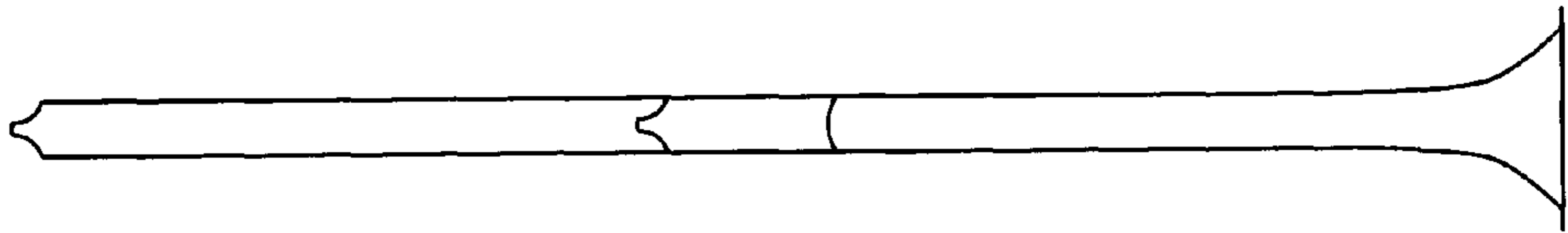

Fig. 19

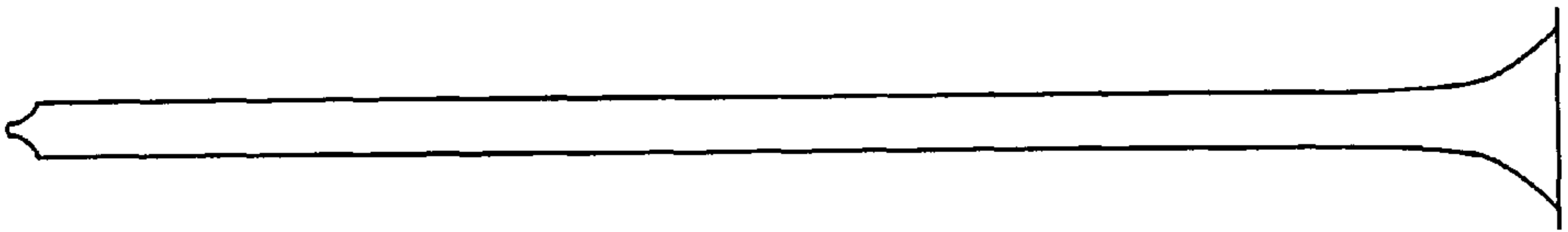

Fig. 20



Fig. 21

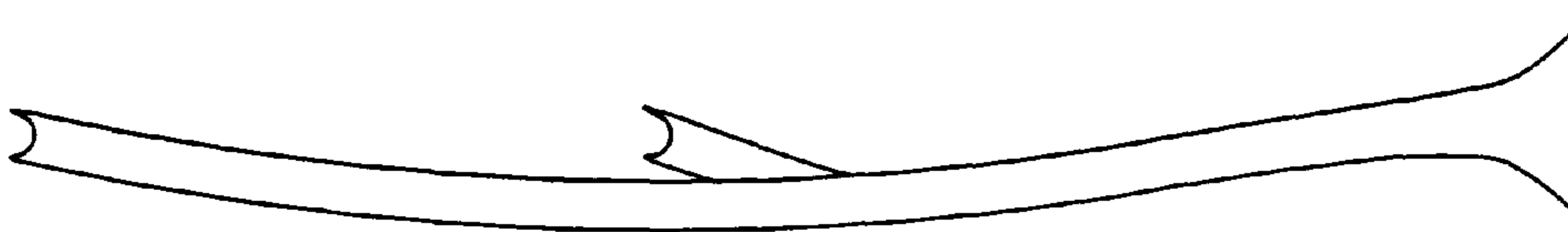

Fig. 22

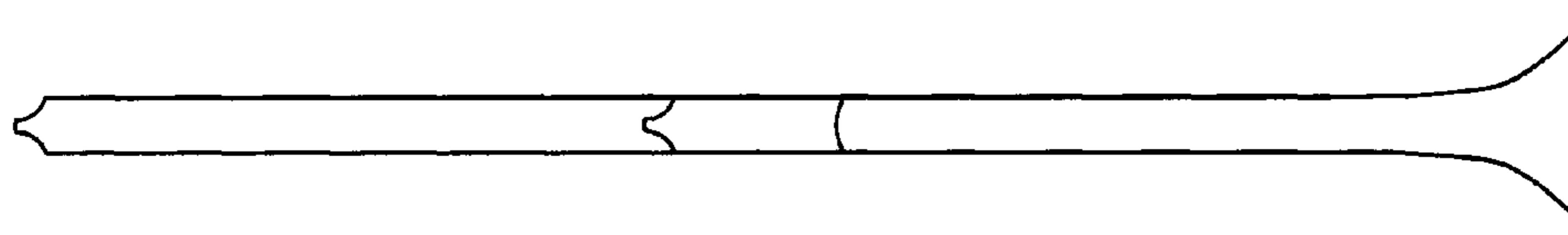

Fig. 23

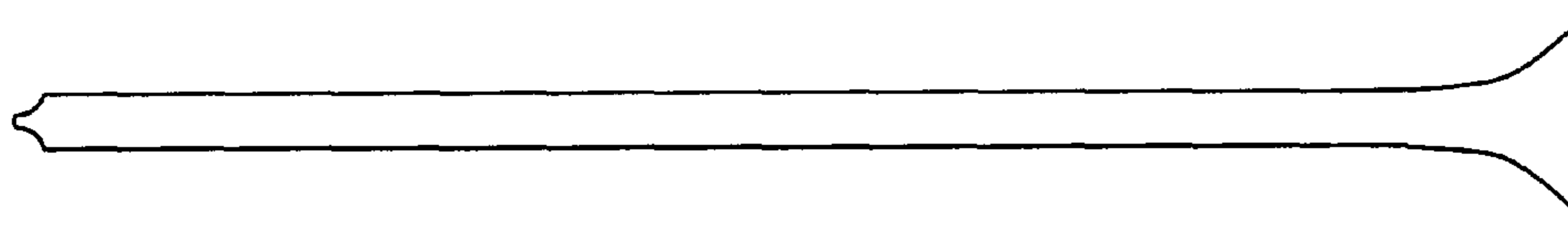

Fig. 24

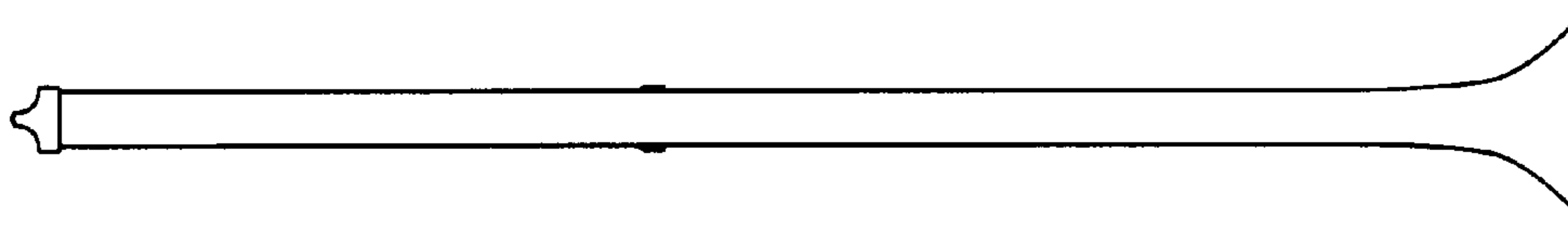

Fig. 28

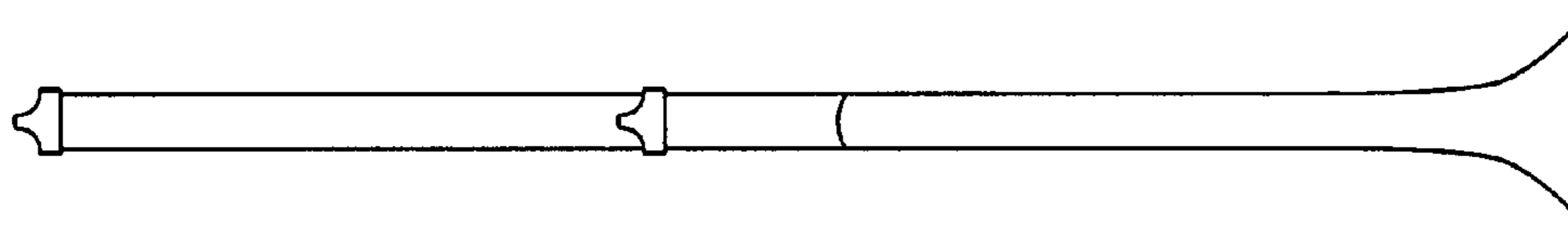

Fig. 27



Fig. 26



Fig. 25



Fig. 29



Fig. 30

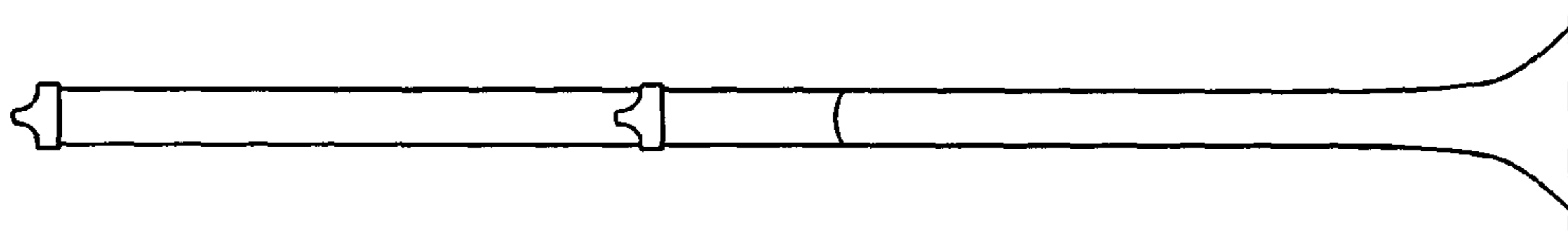

Fig. 31



Fig. 32

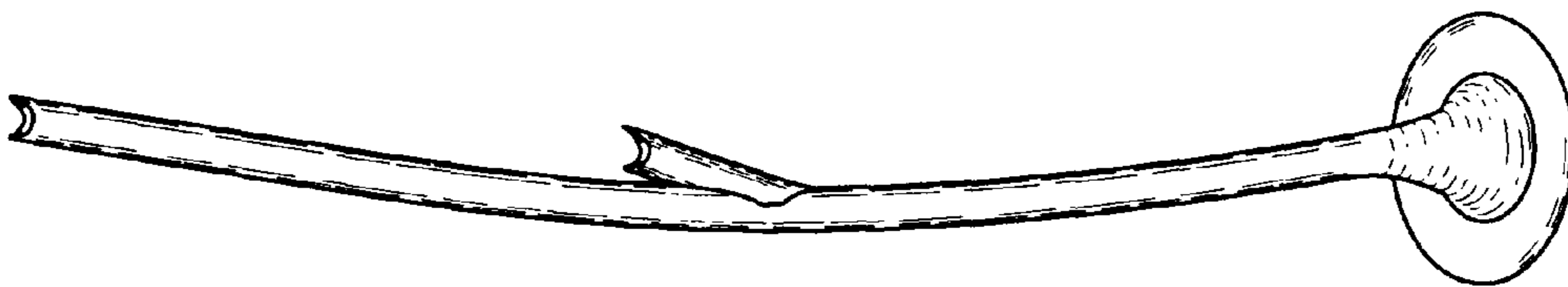

Fig. 33

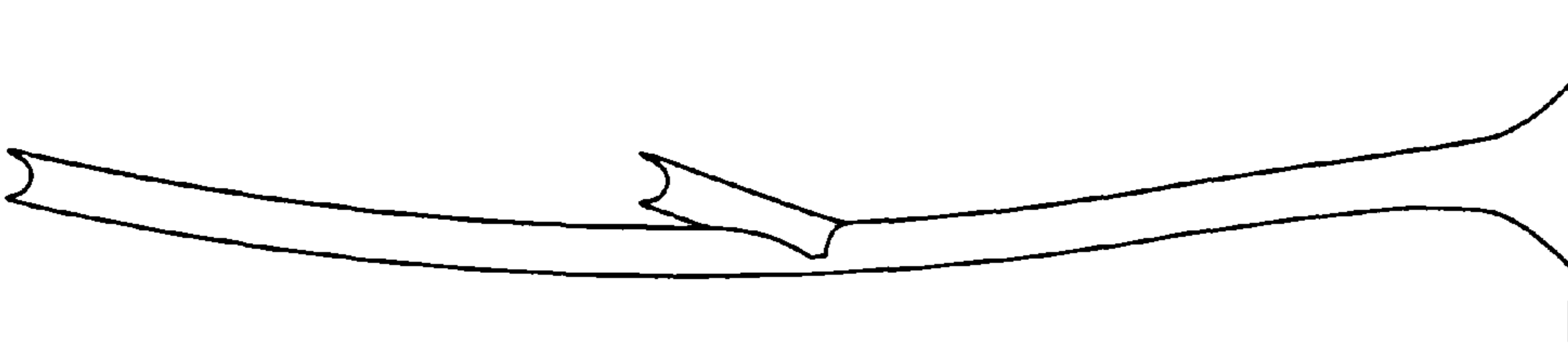

Fig. 34

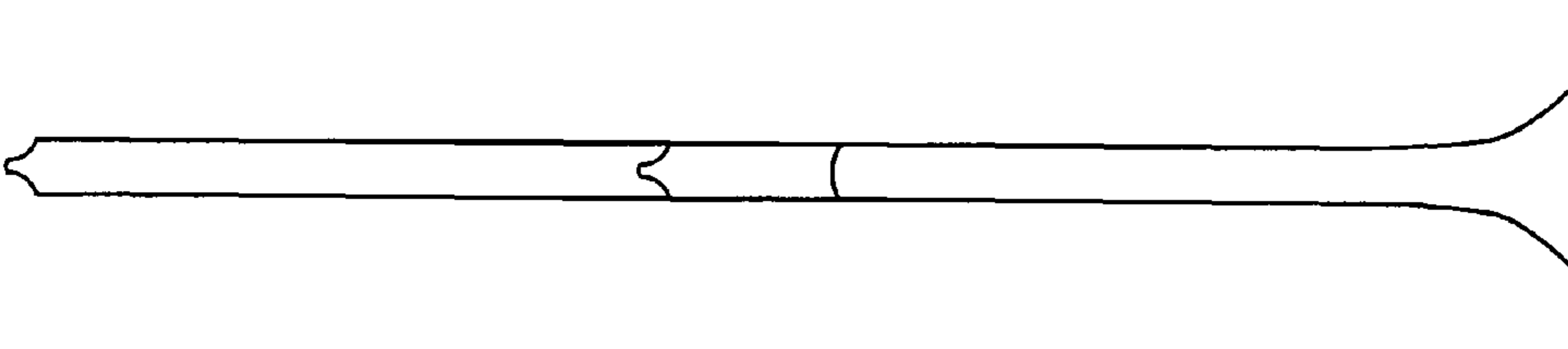

Fig. 35

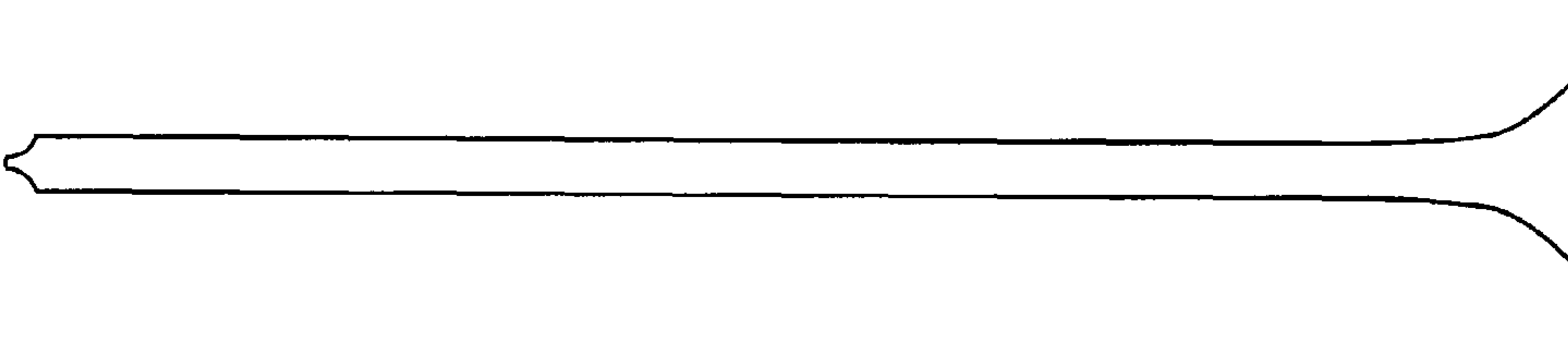

Fig. 36

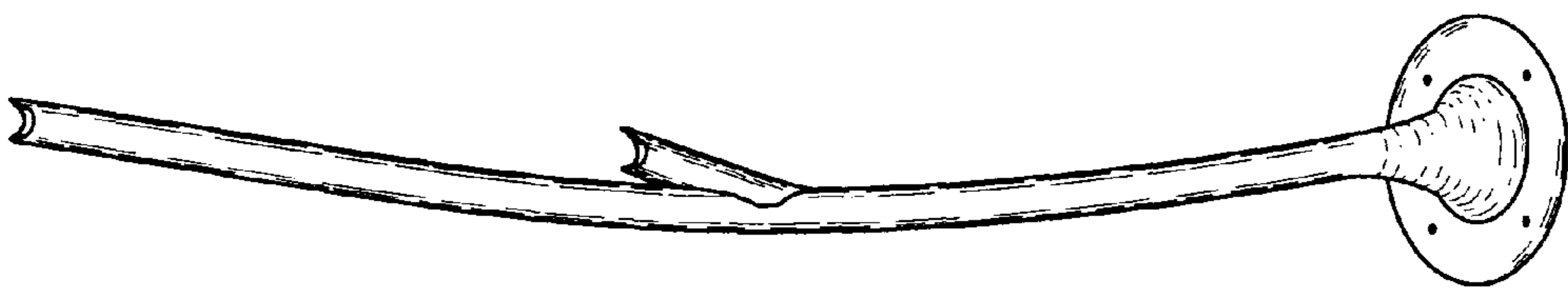

Fig. 37

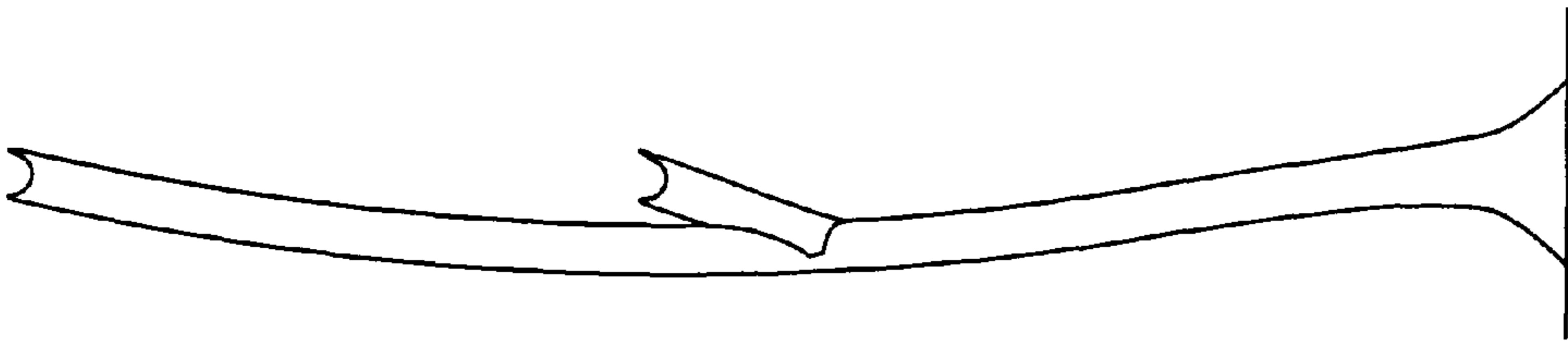

Fig. 38

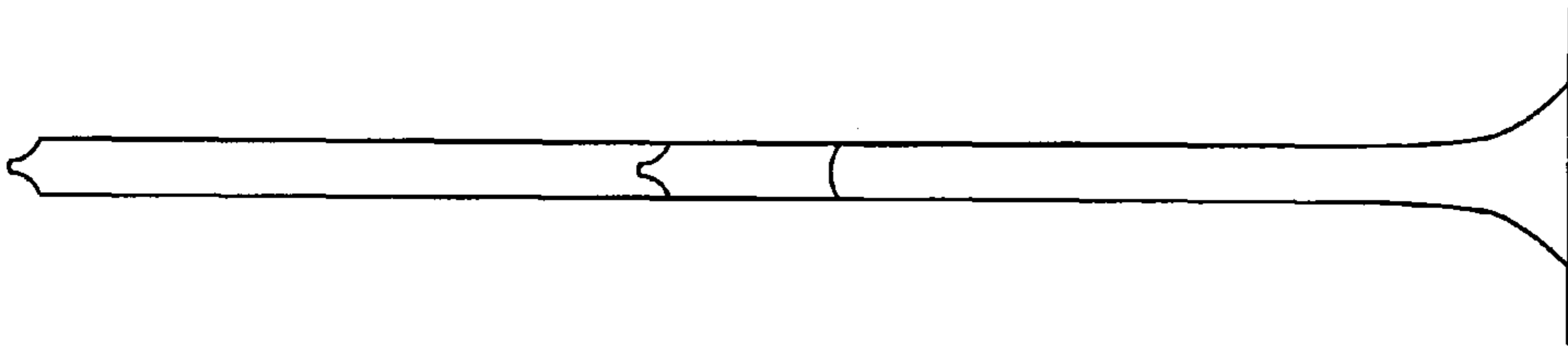

Fig. 39

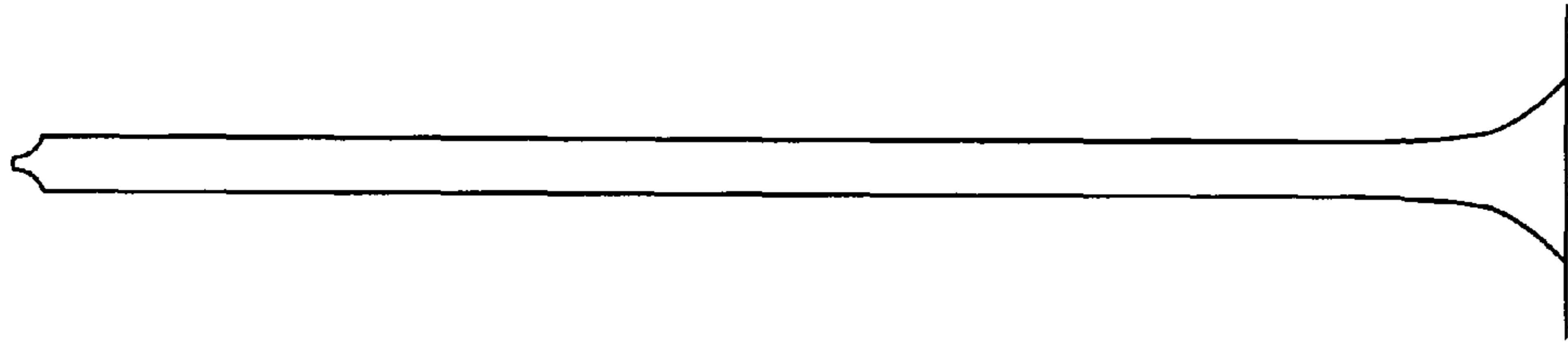

Fig. 40

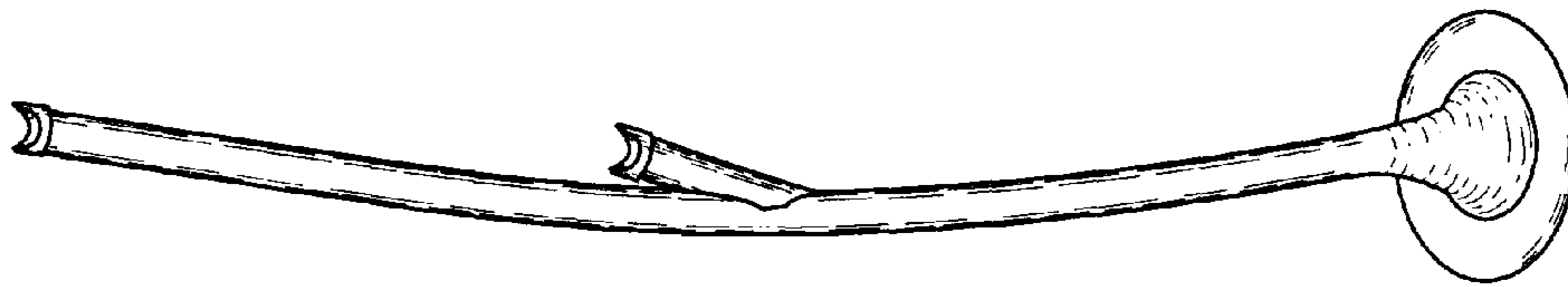

Fig. 41

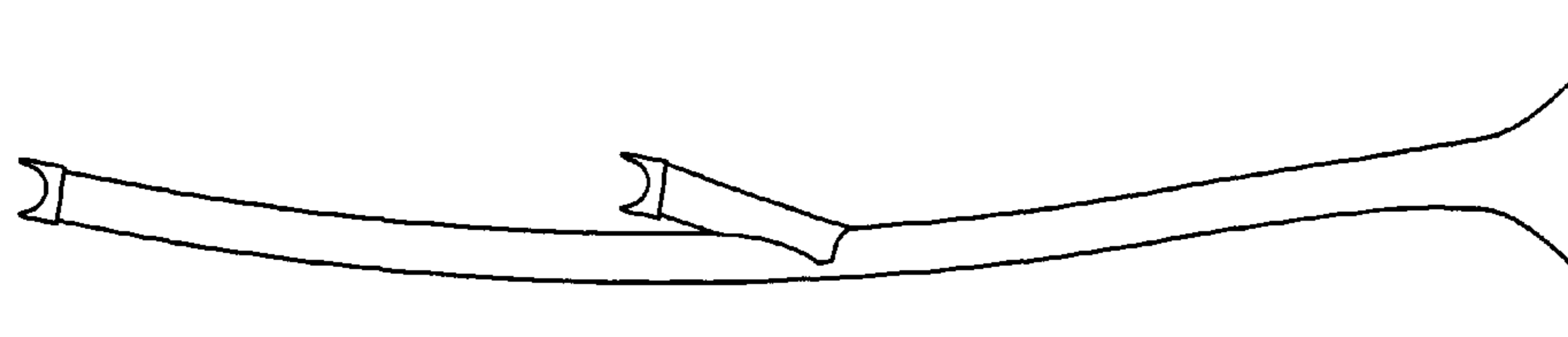

Fig. 42

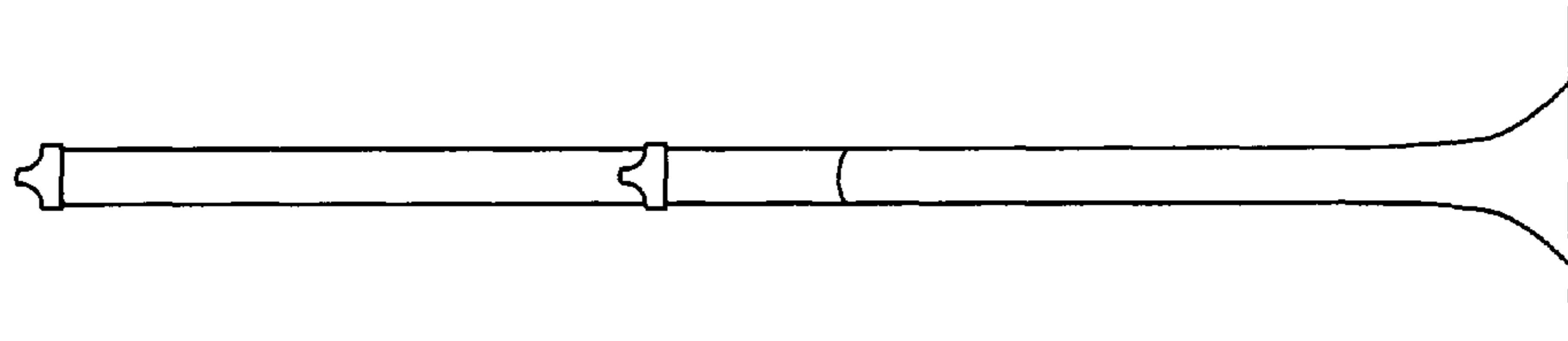

Fig. 43

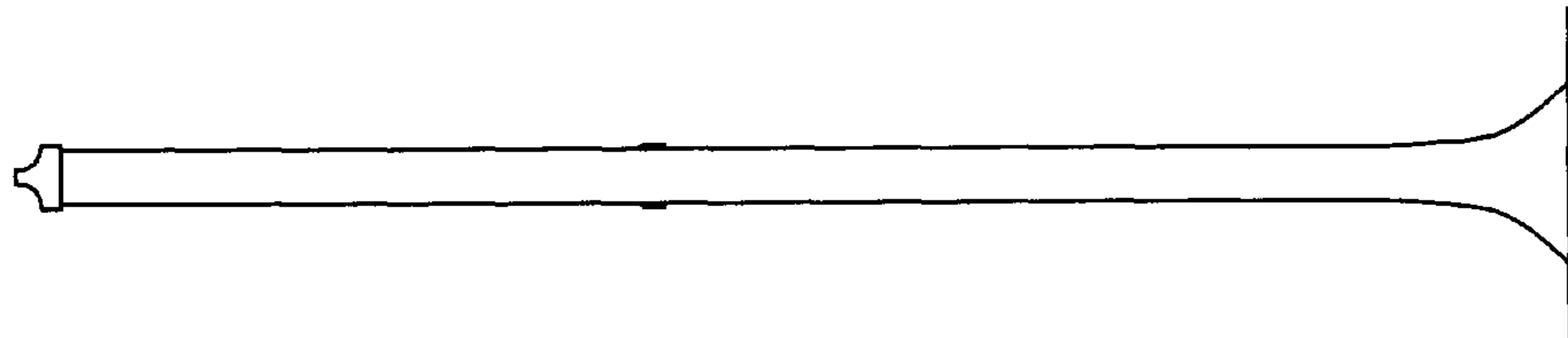

Fig. 44

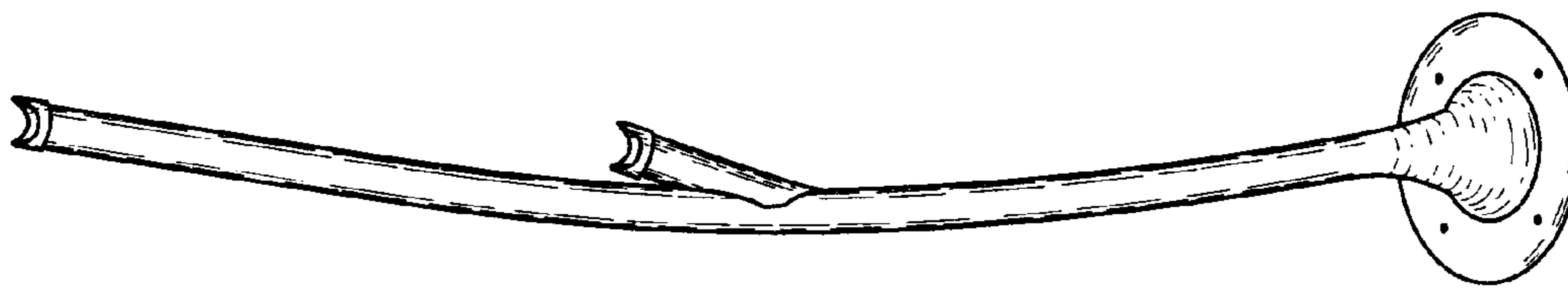

Fig. 45

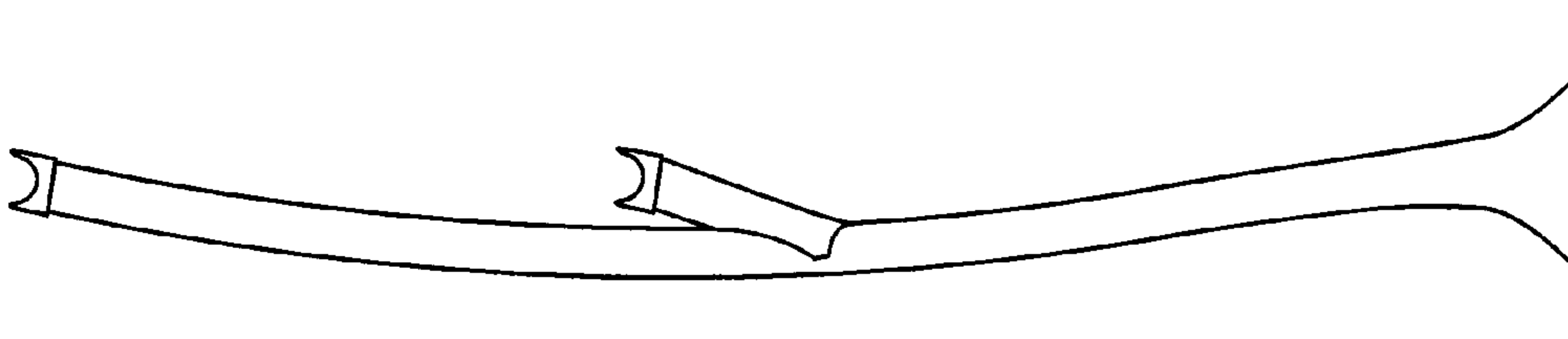

Fig. 46

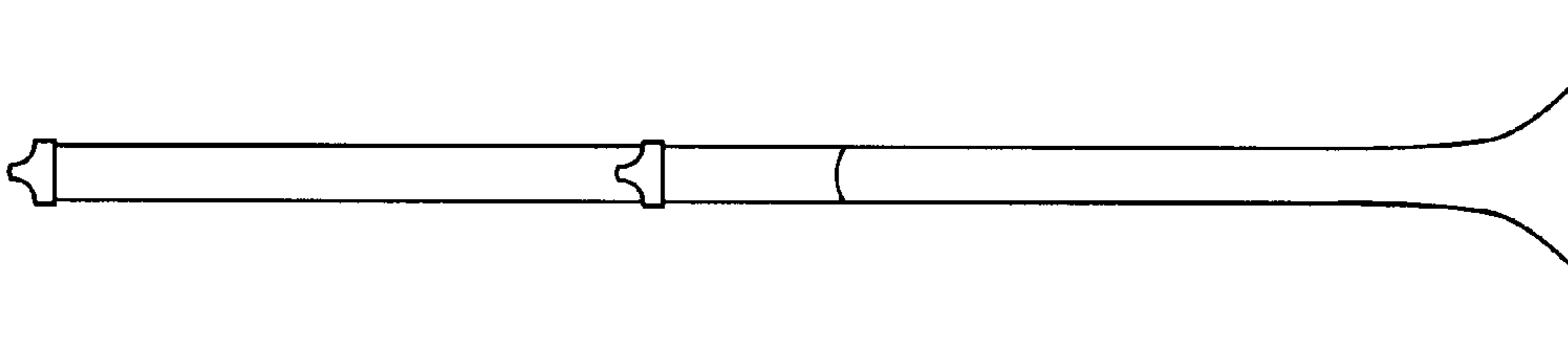

Fig. 47

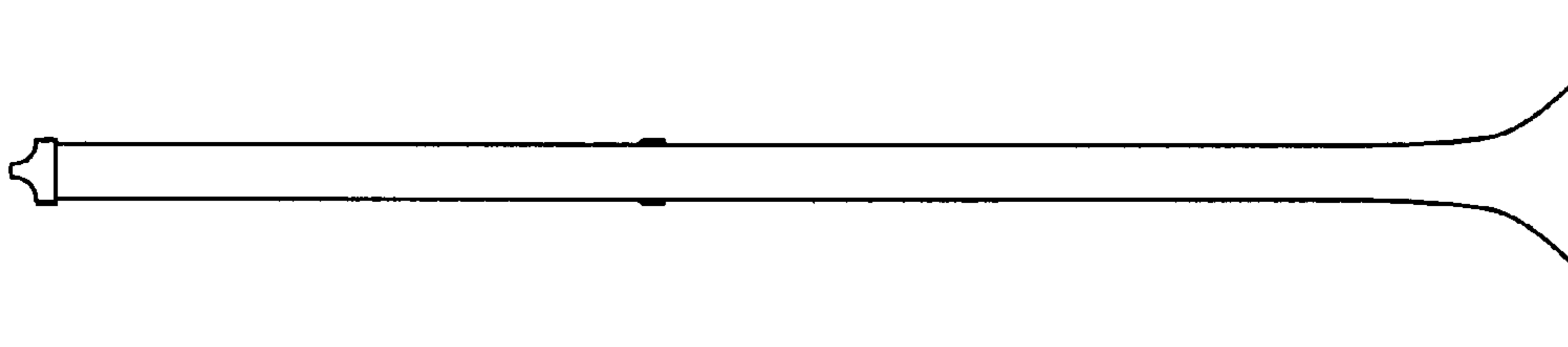

Fig. 48

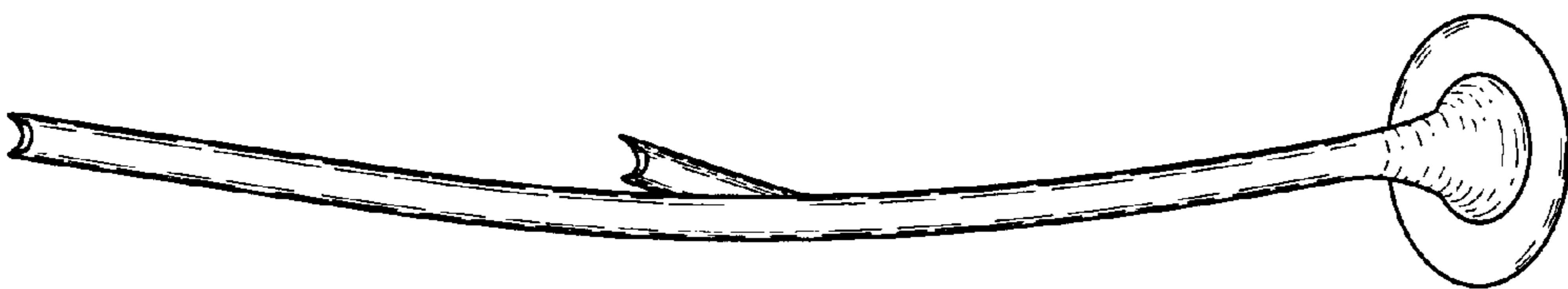

Fig. 49

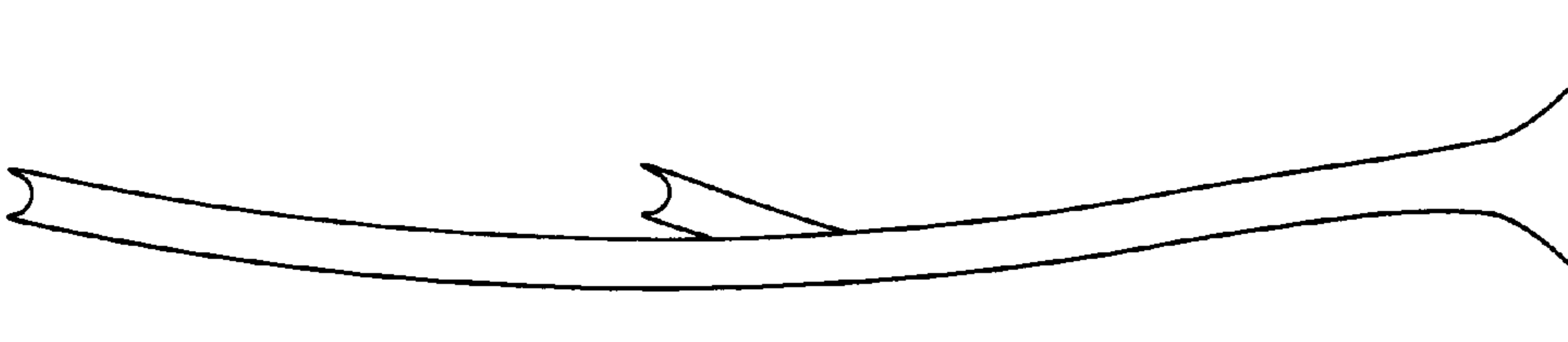

Fig. 50

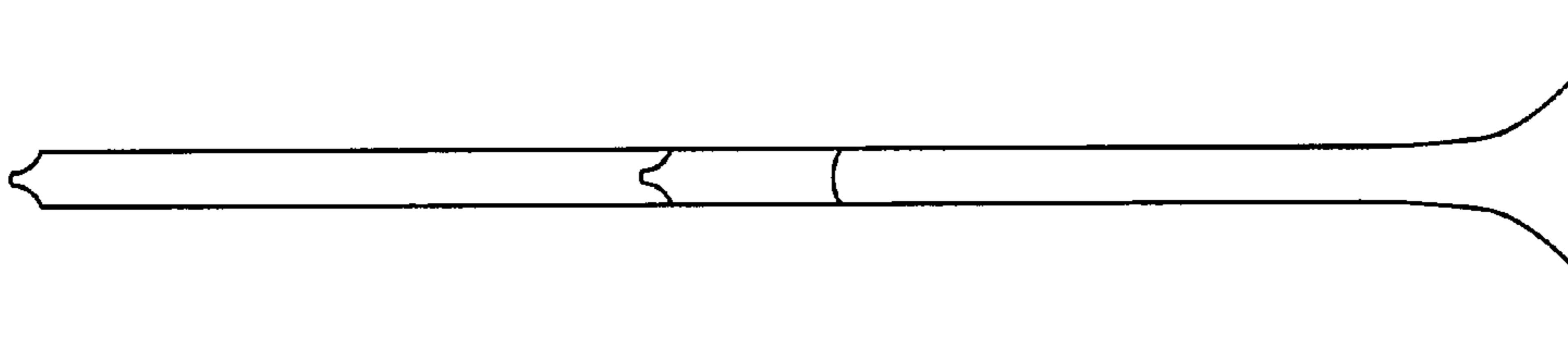

Fig. 51

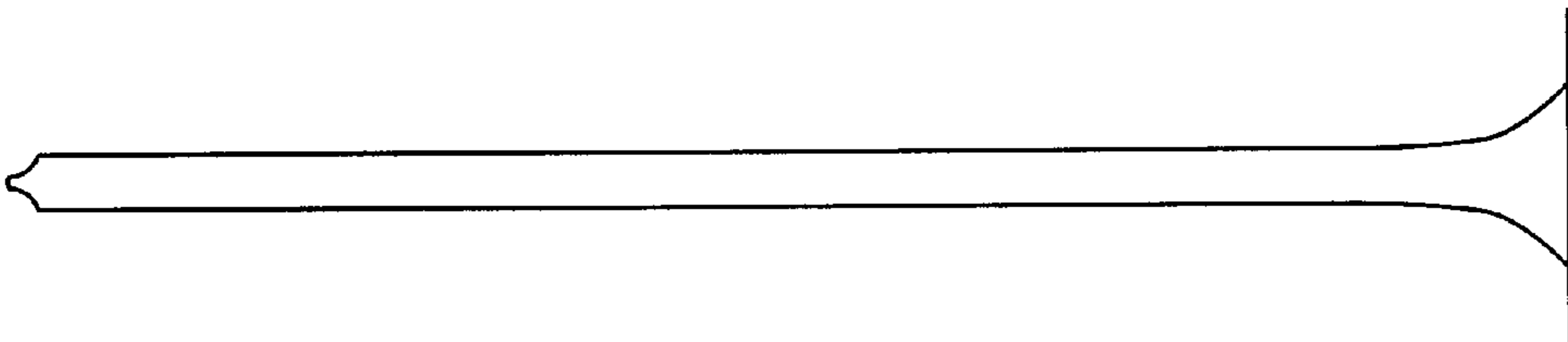

Fig. 52

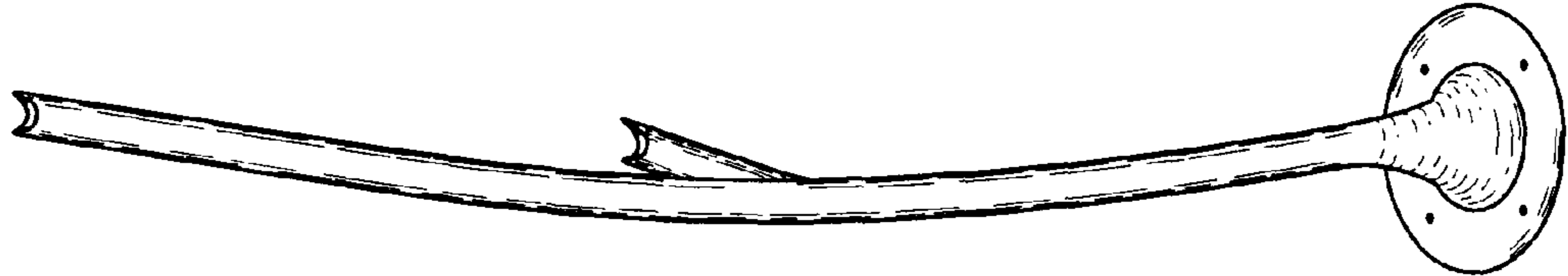

Fig. 53

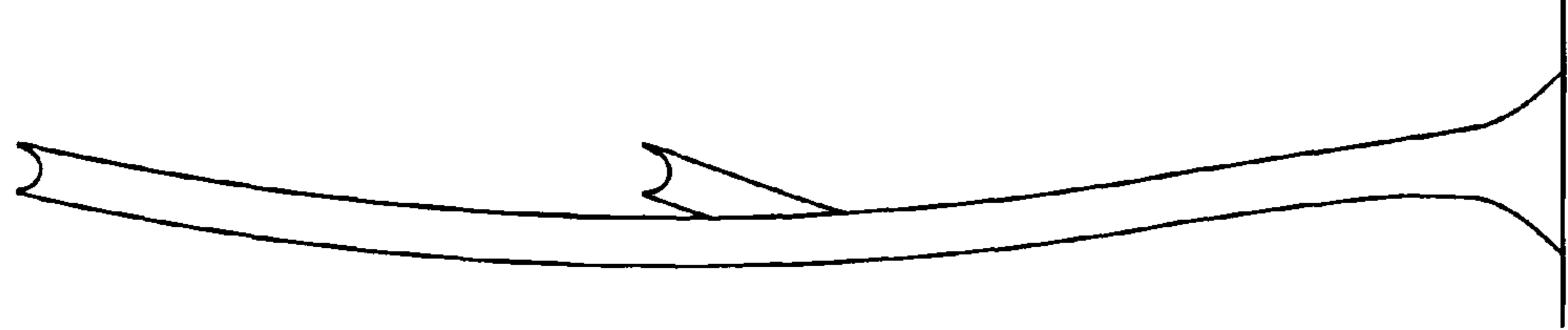

Fig. 54

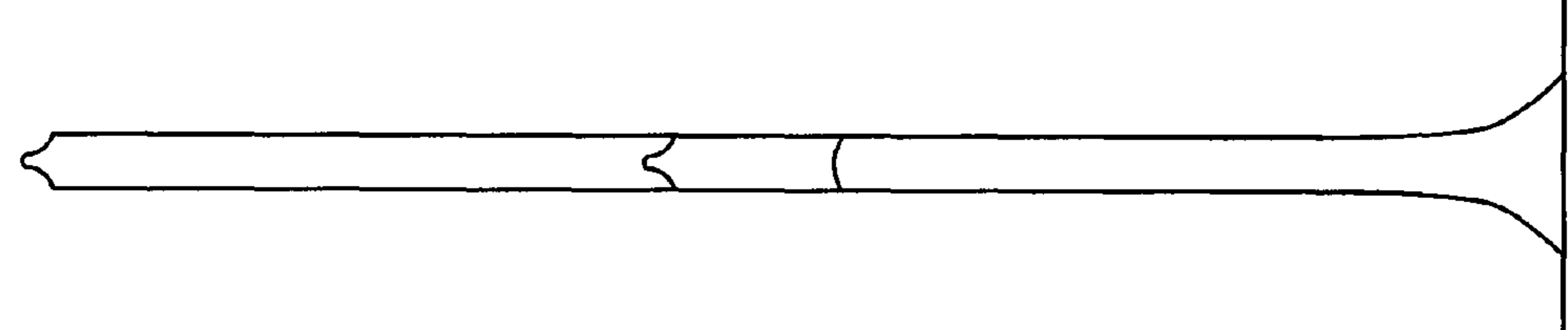

Fig. 55

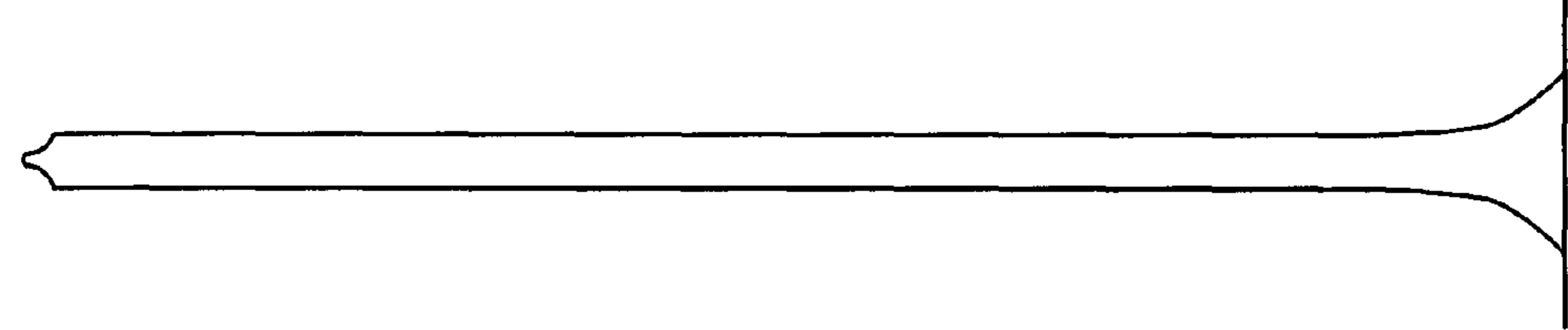

Fig. 56

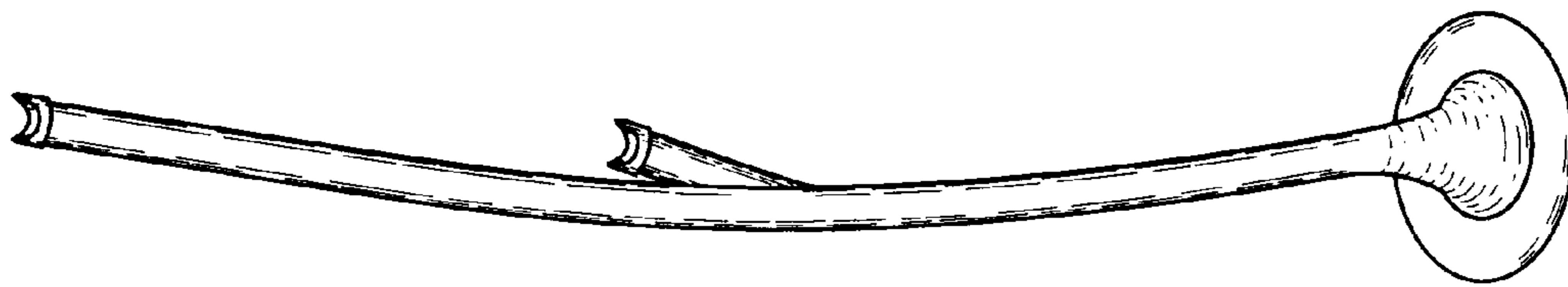

Fig. 57

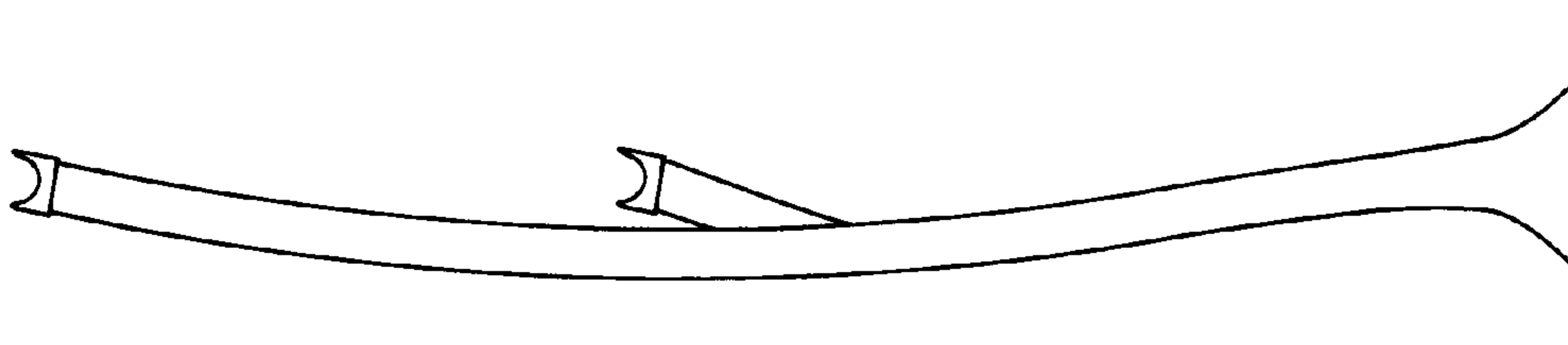

Fig. 58

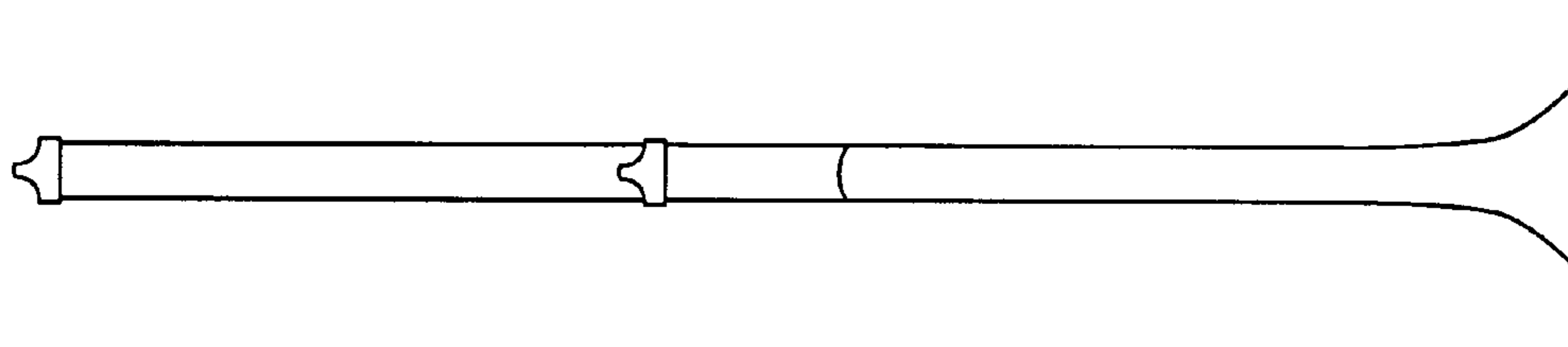

Fig. 59

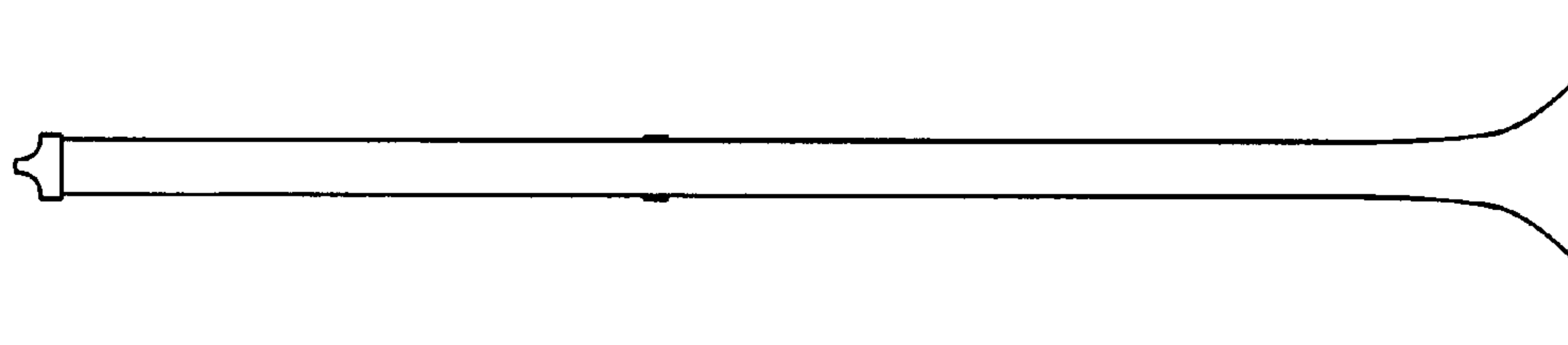

Fig. 60

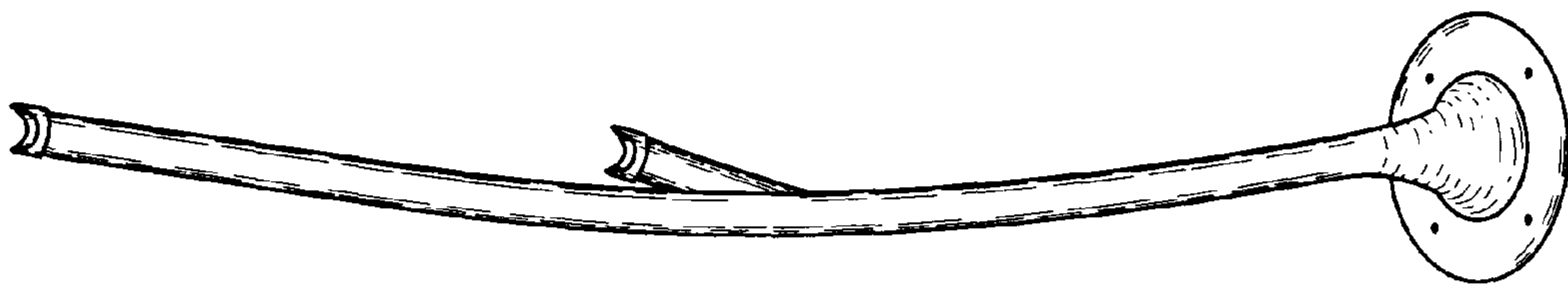

Fig. 61

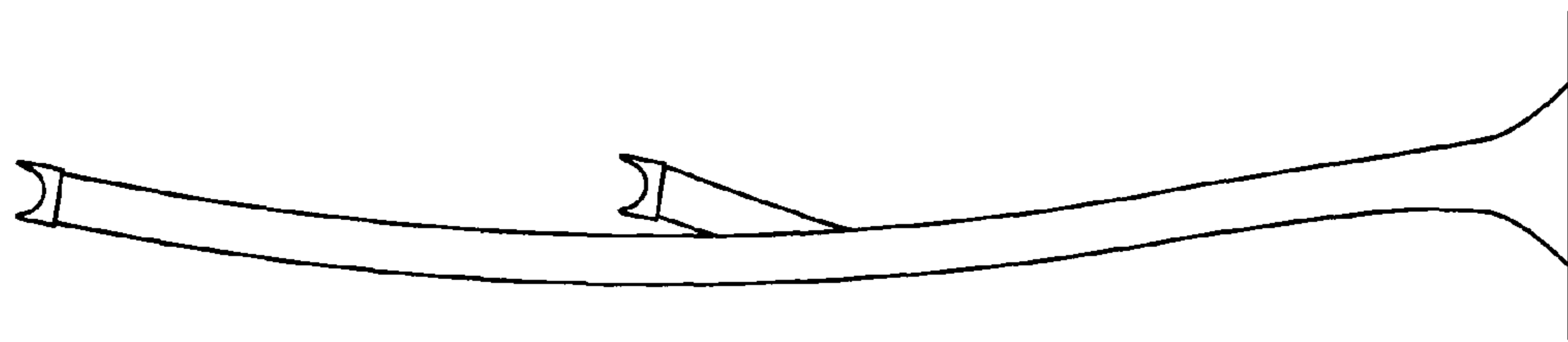

Fig. 62

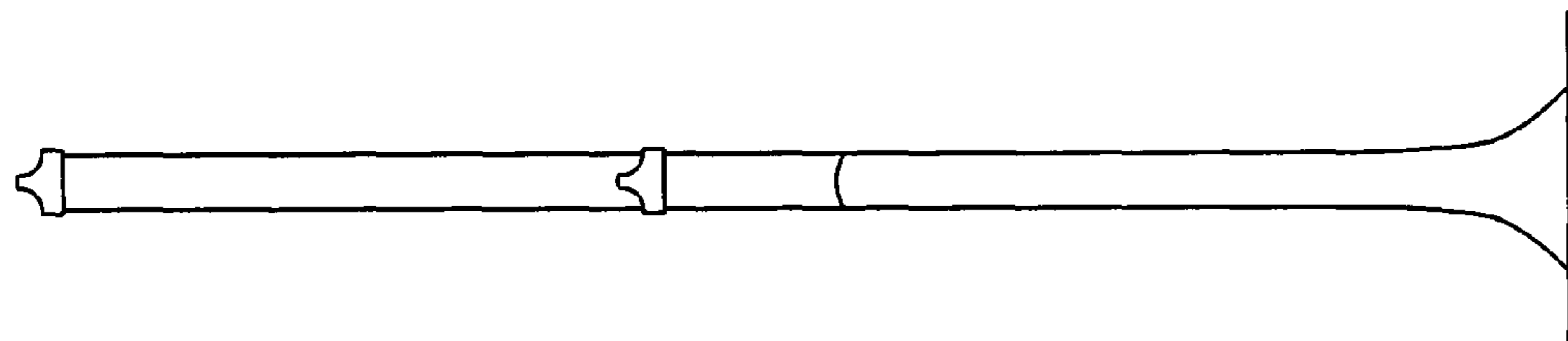

Fig. 63

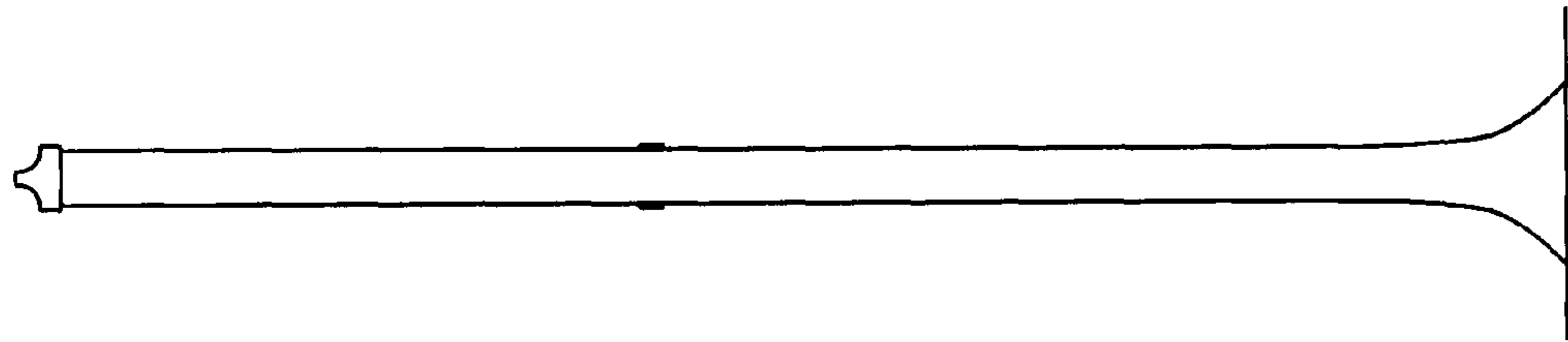

Fig. 64