



US00D689786S

(12) **United States Design Patent**
Flores

(10) **Patent No.:** **US D689,786 S**

(45) **Date of Patent:** **** Sep. 17, 2013**

(54) **BRACELET AND NECKLACE SET**

(71) Applicant: **Ramiro Flores**, Waukegan, IL (US)

(72) Inventor: **Ramiro Flores**, Waukegan, IL (US)

(**) Term: **14 Years**

(21) Appl. No.: **29/439,797**

(22) Filed: **Dec. 14, 2012**

(51) **LOC (9) Cl.** **11-01**

(52) **U.S. Cl.**
USPC **D11/3**

(58) **Field of Classification Search**
USPC D11/1-25, 26-31, 63-69, 79-85;
63/3, 3.1, 3.2, 1.11, 1.16, 4, 15, 18
See application file for complete search history.

(56) **References Cited**

U.S. PATENT DOCUMENTS

D9,955 S *	5/1877	Woods	D11/84
D56,391 S *	10/1920	Sudarov	D11/92
2,119,039 A *	5/1938	Boyd	63/15
D121,224 S *	6/1940	Philippe	D11/6
2,242,912 A	5/1941	Healy		
D133,373 S *	8/1942	Meyer	D11/67
D142,969 S *	11/1945	Rubel	D11/1
D148,023 S *	12/1947	Johnson	D11/5
D160,246 S *	9/1950	Brandano	D11/40
D167,041 S *	6/1952	Katz	D11/66

D177,820 S *	5/1956	Katz	D11/86
D237,815 S *	11/1975	Bulgari et al.	D11/5
4,078,330 A *	3/1978	Roth	D11/5
4,087,989 A	5/1978	Taran		
D248,286 S *	6/1978	Barr	D11/34
D285,781 S	9/1986	Carter		
4,974,429 A	12/1990	Ferrara		
D334,900 S *	4/1993	Bulgari	D11/5
6,397,854 B1	6/2002	Bailey		
6,554,684 B2	4/2003	Marlin		
D474,338 S *	5/2003	Anderson	D11/63
6,718,797 B2	4/2004	Plumly		
D494,883 S *	8/2004	Pachachi	D11/33
7,823,414 B2 *	11/2010	Benos	63/23

* cited by examiner

Primary Examiner — Jennifer Rivard
Assistant Examiner — Melanie Pellegrini

(57) **CLAIM**

The ornamental design for a bracelet and necklace set, as shown and described.

DESCRIPTION

FIG. 1 is a front view of a bracelet and necklace set showing my new design;
FIG. 2 is a back view thereof;
FIG. 3 is a side view thereof;
FIG. 4 is an opposite side view thereof;
FIG. 5 is a top view thereof; and,
FIG. 6 is a bottom view thereof.

1 Claim, 6 Drawing Sheets

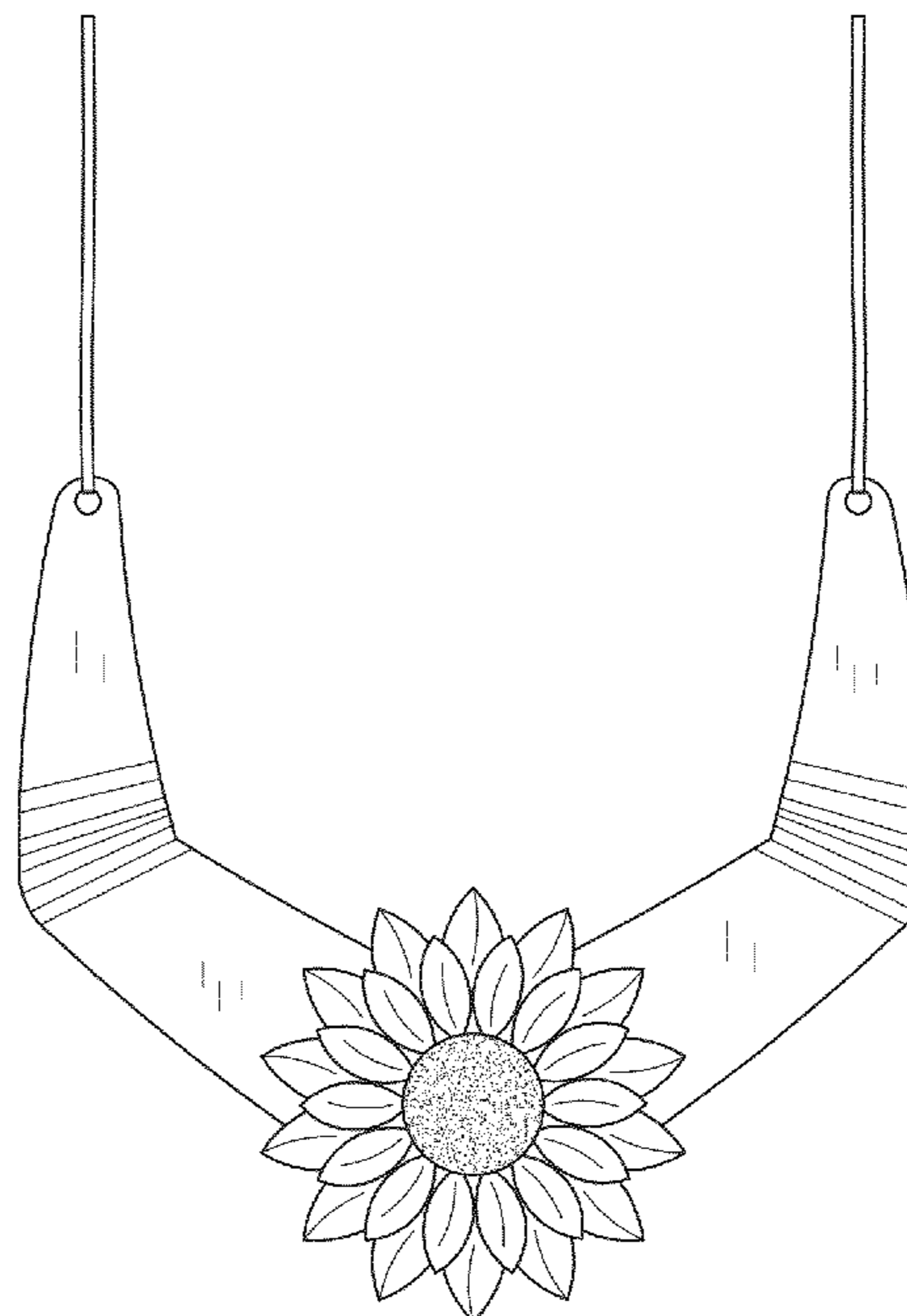
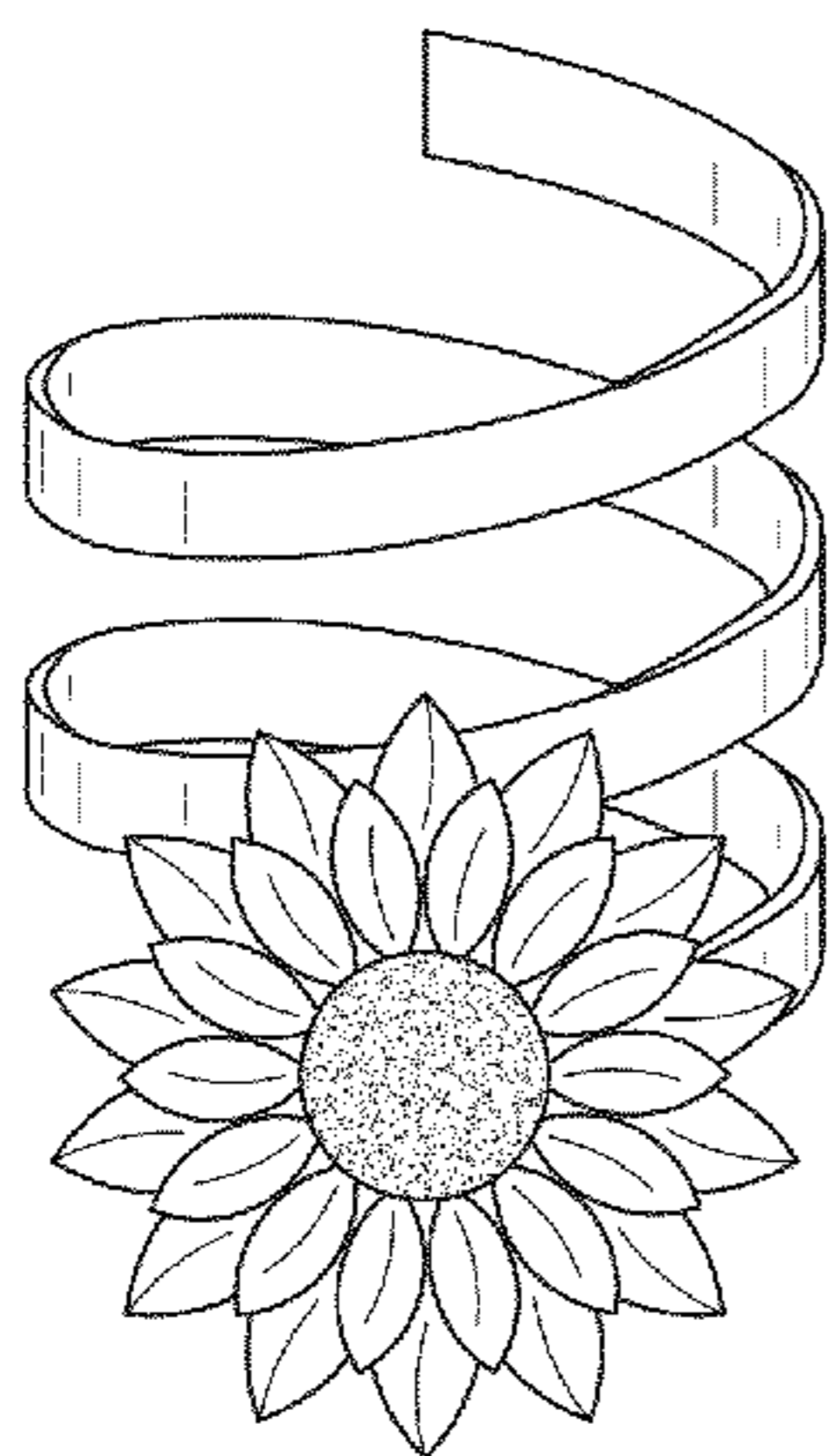

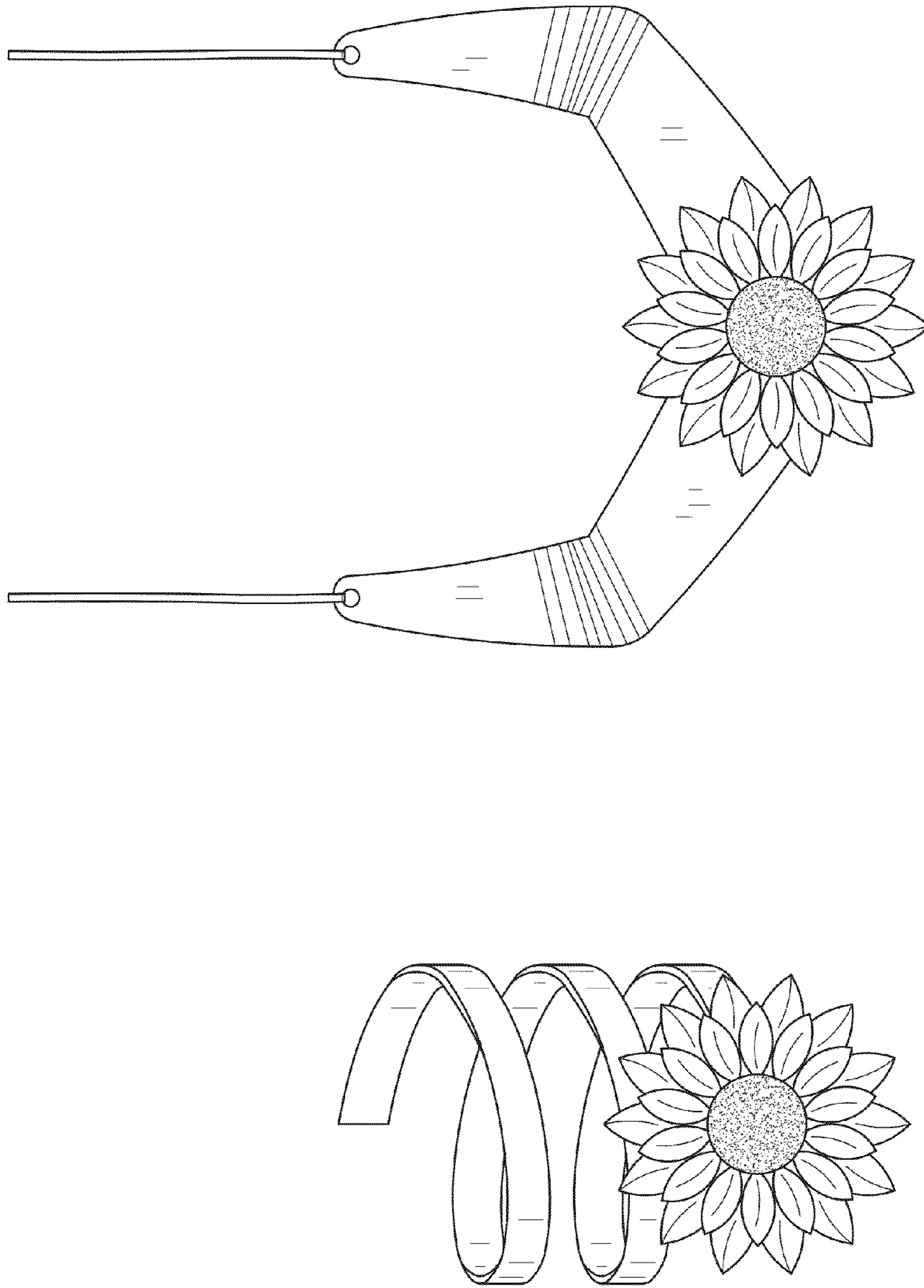

FIG. 1

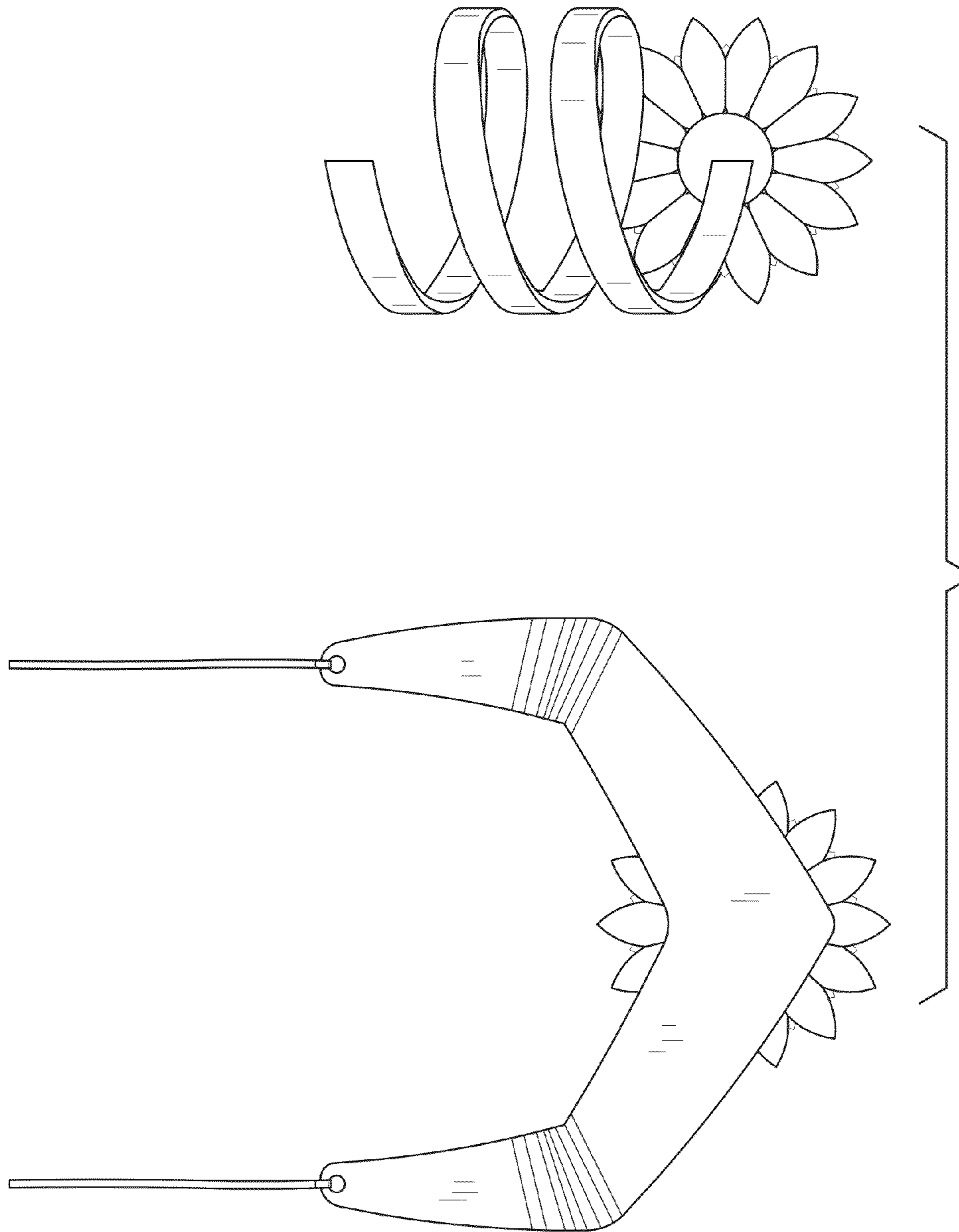

FIG. 2

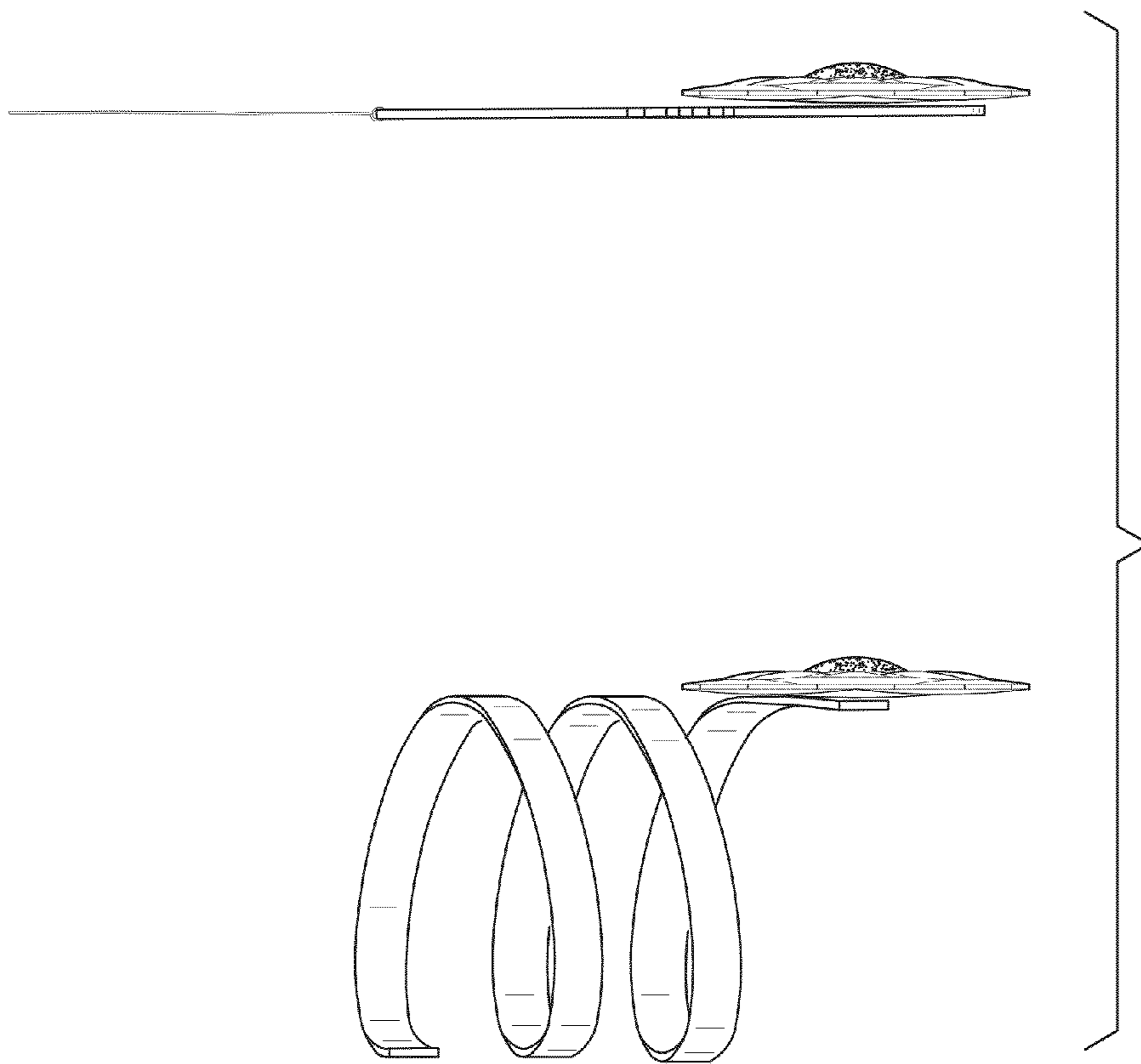

FIG. 3

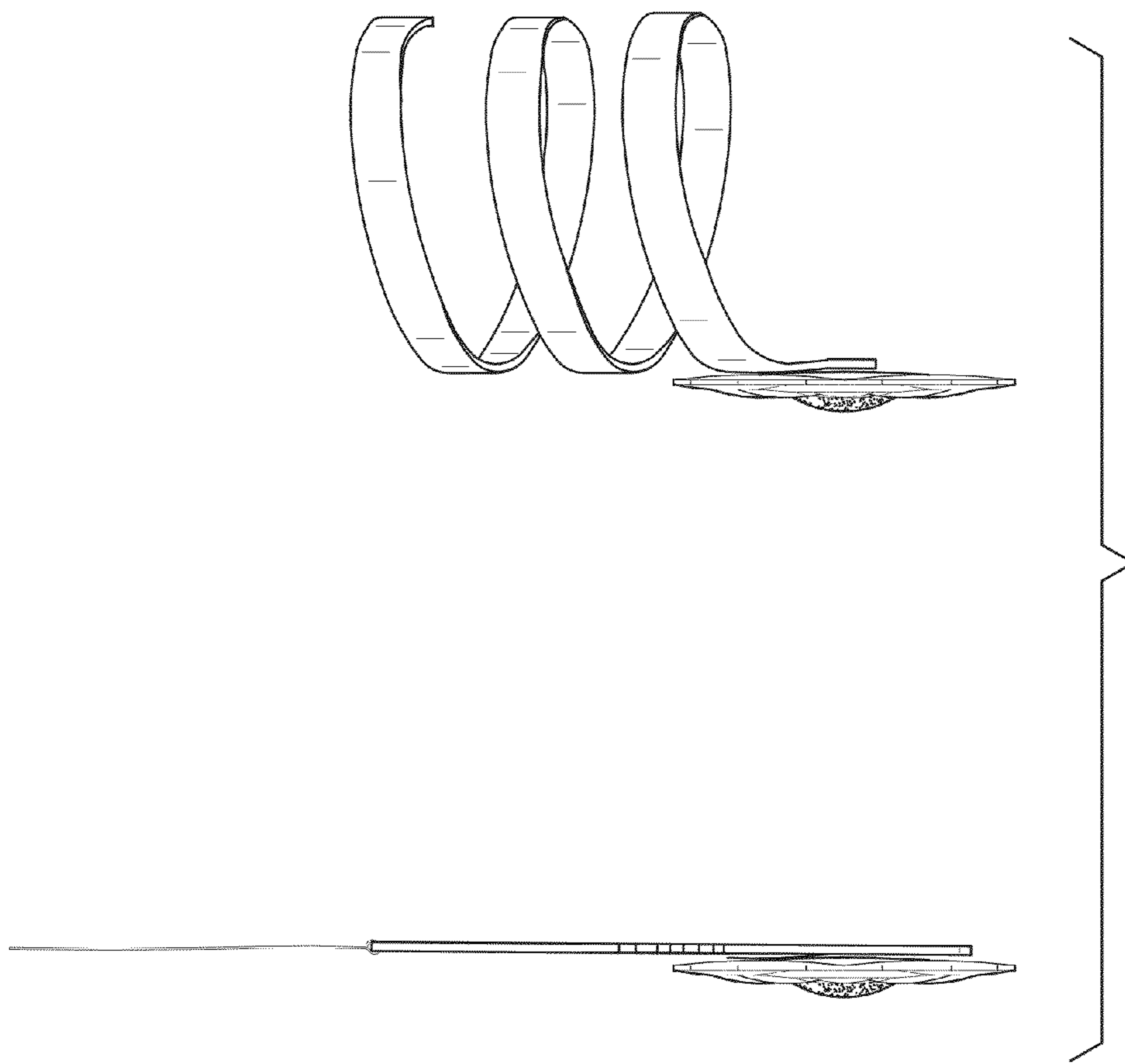

FIG. 4

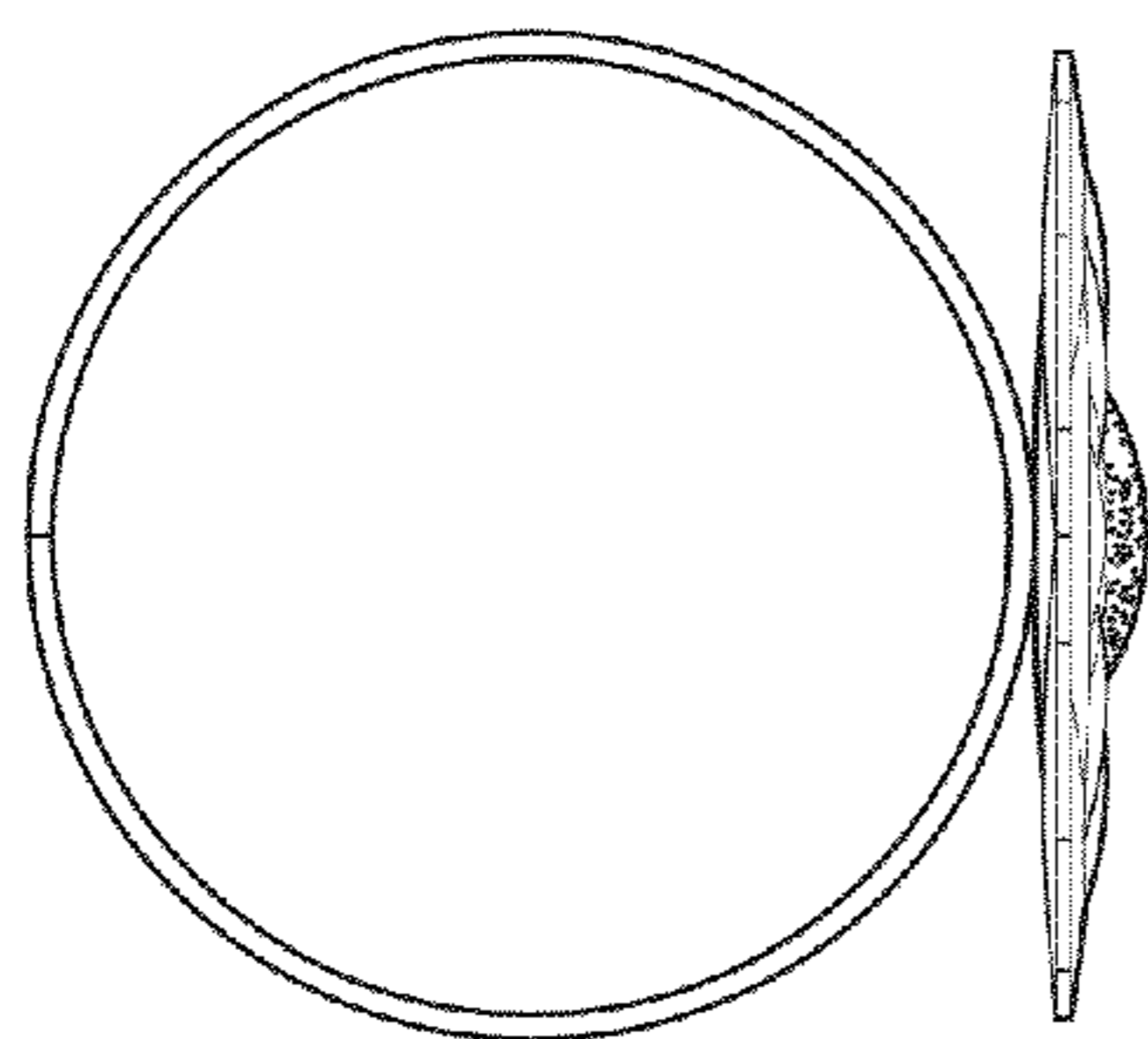

FIG. 5

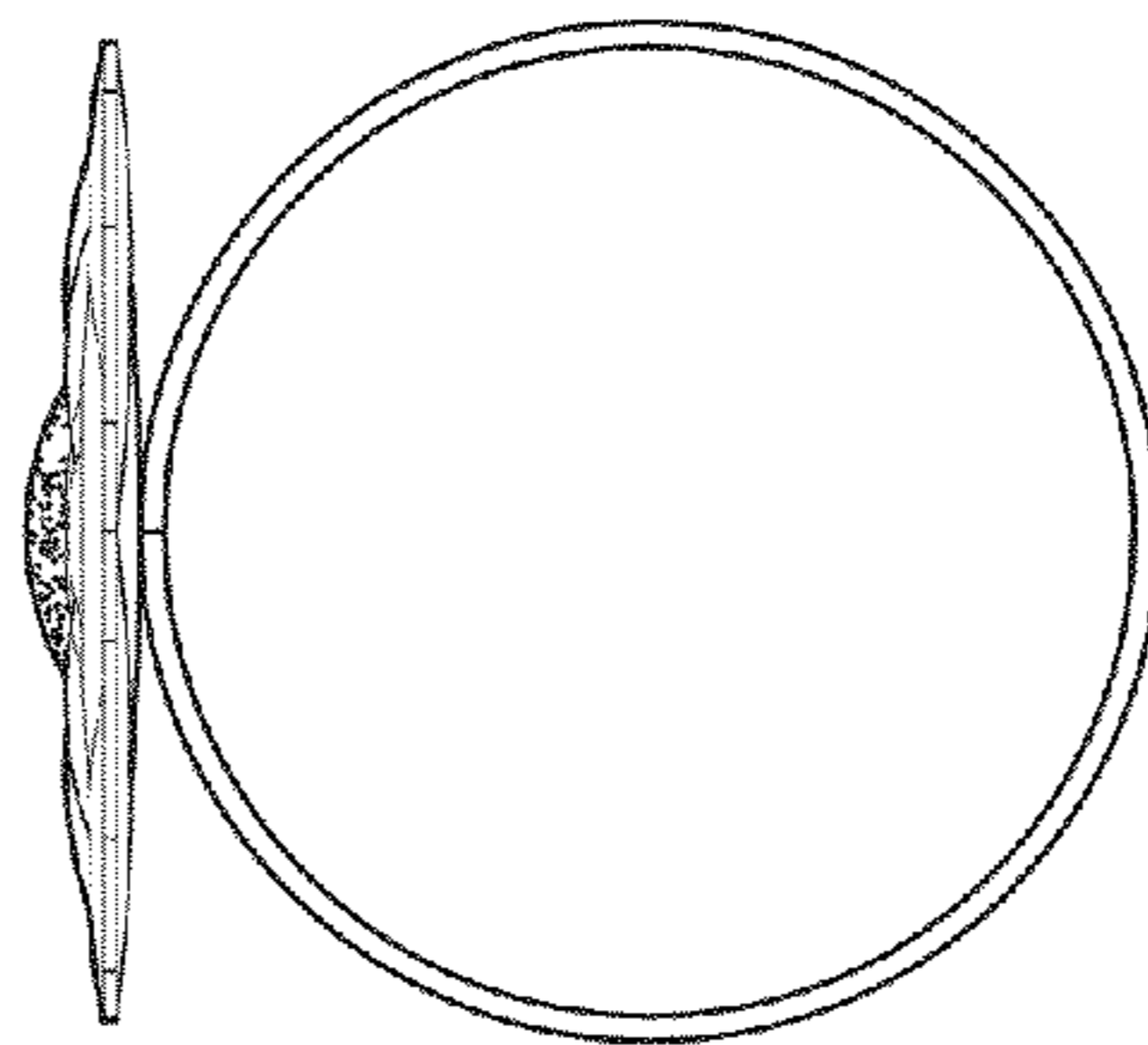
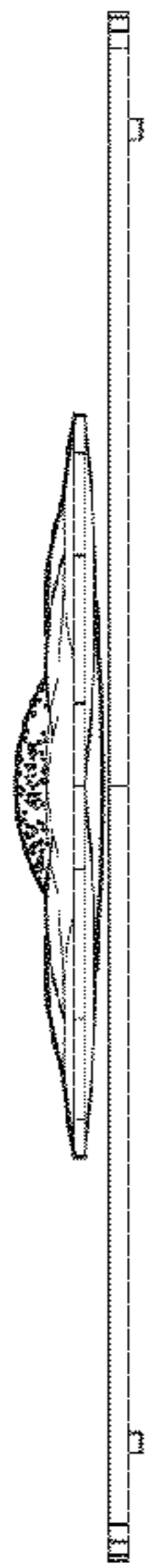

FIG. 6