



US00D689754S

(12) **United States Design Patent**  
**Hayakawa et al.**

(10) **Patent No.:** **US D689,754 S**

(45) **Date of Patent:** **\*\* Sep. 17, 2013**

(54) **PORTABLE ELECTRIC DRILL**

(75) Inventors: **Noahiro Hayakawa**, Anjo (JP); **Ya Li Zhou**, Jiangsu (CN)

(73) Assignee: **Makita Corporation**, Anjo-shi (JP)

(\*\*) Term: **14 Years**

(21) Appl. No.: **29/428,586**

(22) Filed: **Aug. 1, 2012**

(30) **Foreign Application Priority Data**

Mar. 30, 2012 (JP) ..... 2012-007496

(51) **LOC (9) Cl.** ..... **08-01**

(52) **U.S. Cl.**  
USPC ..... **D8/61**

(58) **Field of Classification Search**  
USPC ..... D8/61, 62, 67, 69; 81/57, 57.11,  
81/57.14, 57.26, 429, 464, 469; 173/2, 170,  
173/176, 181

See application file for complete search history.

(56) **References Cited**

**U.S. PATENT DOCUMENTS**

D559,639 S *	1/2008	Henssler et al.	.....	D8/61
D567,046 S *	4/2008	Henssler et al.	.....	D8/61
D568,704 S *	5/2008	Aglassinger	.....	D8/62
D576,461 S *	9/2008	Bast	.....	D8/62
D588,891 S	3/2009	Hayakawa et al.		
D598,260 S *	8/2009	Jerome et al.	.....	D8/61
D602,756 S *	10/2009	Henssler et al.	.....	D8/61
D643,700 S *	8/2011	Schultheiss et al.	.....	D8/64
D647,771 S *	11/2011	Schoch et al.	.....	D8/61
D648,997 S *	11/2011	Allan et al.	.....	D8/61
D653,922 S *	2/2012	Henssler et al.	.....	D8/61
D658,464 S *	5/2012	Kawase et al.	.....	D8/61

D662,800 S *	7/2012	Blythe et al.	.....	D8/61
D663,181 S *	7/2012	Zhou et al.	.....	D8/61
D674,676 S *	1/2013	Wang	.....	D8/61
D682,649 S *	5/2013	Aglassinger	.....	D8/61
D683,202 S *	5/2013	Aglassinger	.....	D8/61
2011/0108298 A1 *	5/2011	Zhou	.....	173/122

\* cited by examiner

*Primary Examiner* — Austin Murphy

(74) *Attorney, Agent, or Firm* — Global IP Counselors, LLP

(57) **CLAIM**

The ornamental design for a portable electric drill, as shown and described.

**DESCRIPTION**

FIG. 1 is a front perspective view of a portable electric drill in accordance with our new design;

FIG. 2 is a rear perspective view of the portable electric drill in accordance with our new design;

FIG. 3 is a front elevational view of the portable electric drill in accordance with our new design;

FIG. 4 is a rear elevational view of the portable electric drill in accordance with our new design;

FIG. 5 is a top plan view of the portable electric drill in accordance with our new design;

FIG. 6 is a bottom plan view of the portable electric drill in accordance with our new design;

FIG. 7 is a right side elevational view of the portable electric drill in accordance with our new design;

FIG. 8 is a left side elevational view of the portable electric drill in accordance with our new design; and,

FIG. 9 is a front perspective view of the portable electric drill in accordance with our new design illustrating a state in which a chuck is attached to the portable electric drill.

The broken line showing of environment in FIGS. 1-4, 6 and 9 forms no part of the claimed design.

**1 Claim, 8 Drawing Sheets**

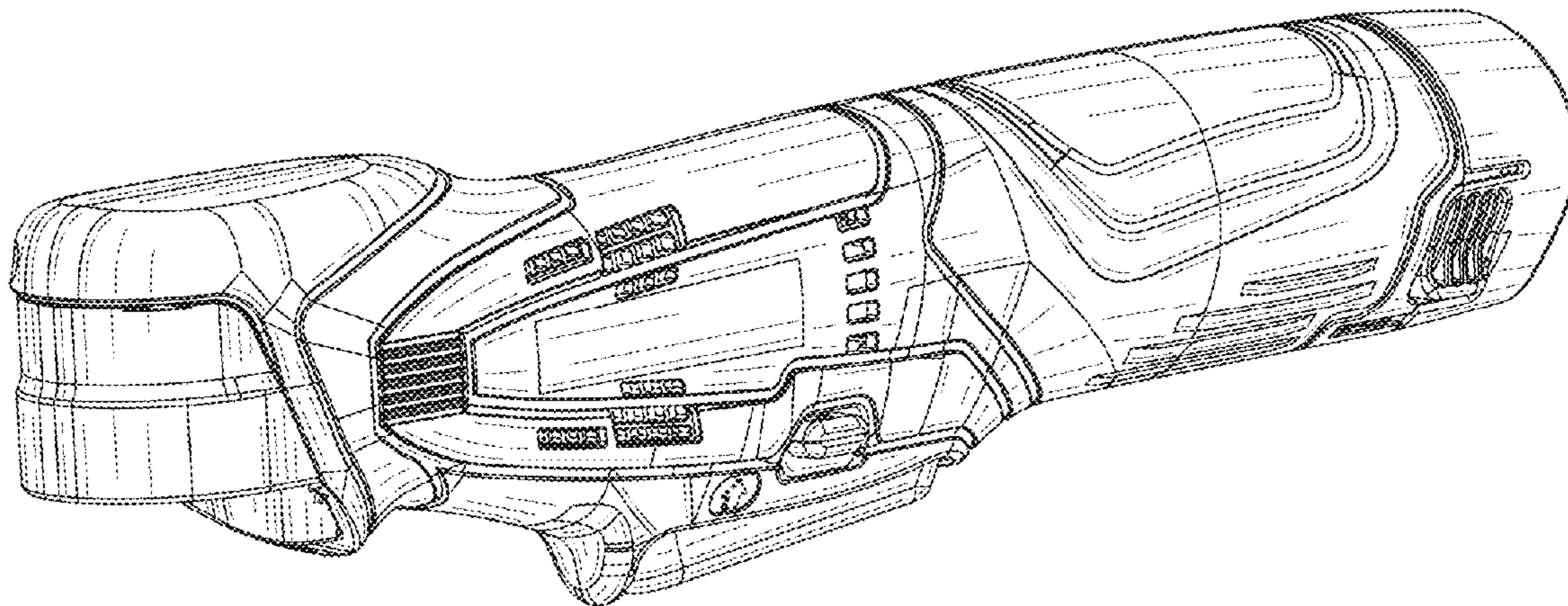

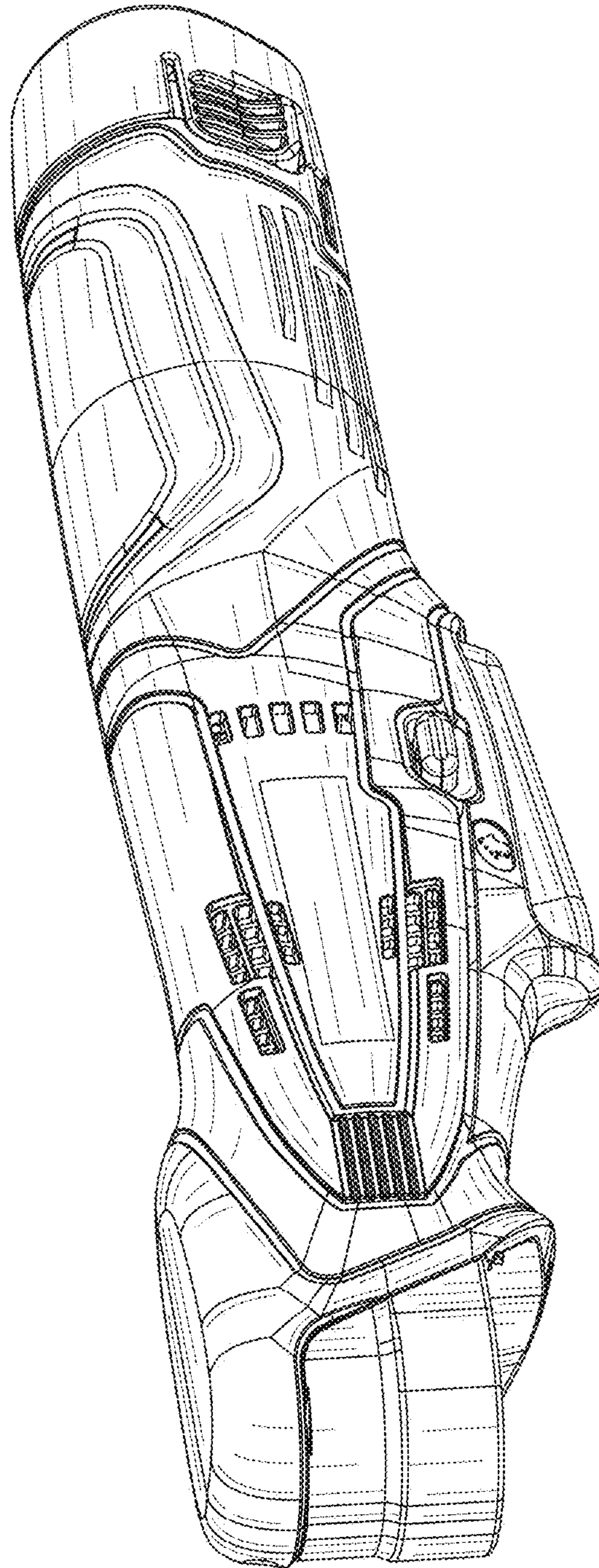

FIG. 1



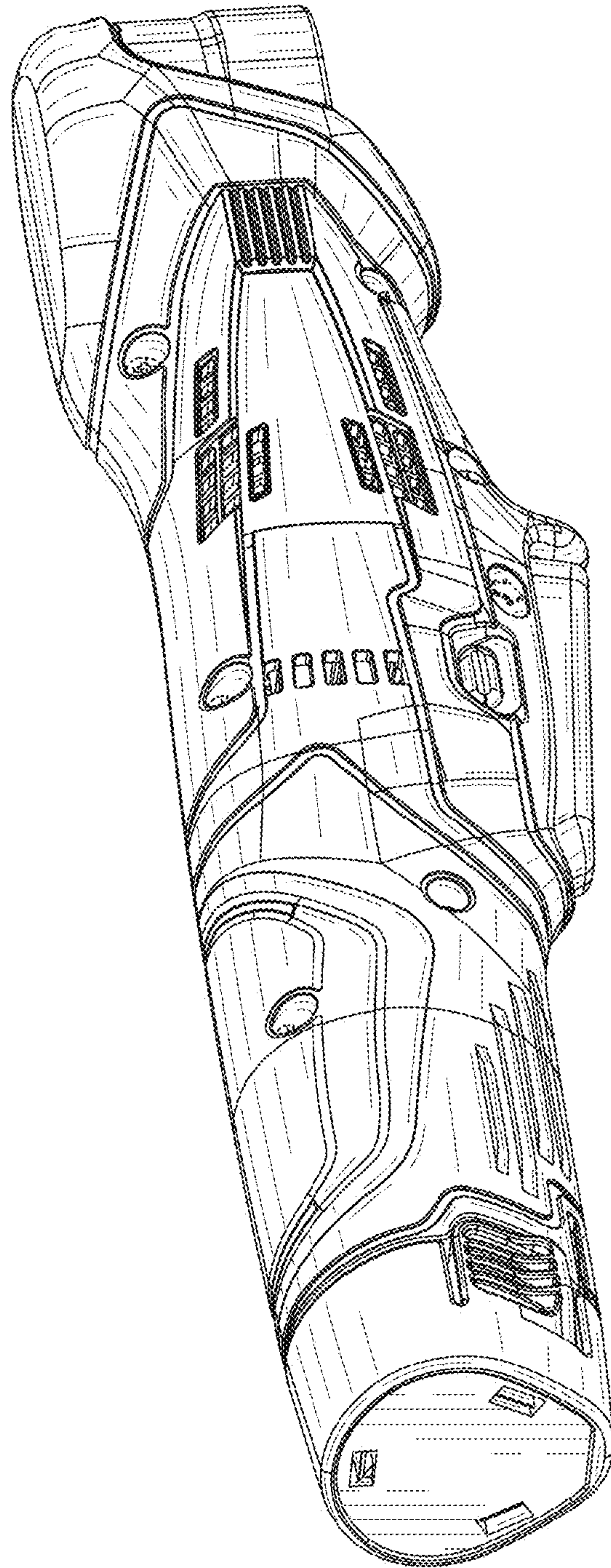

FIG. 2

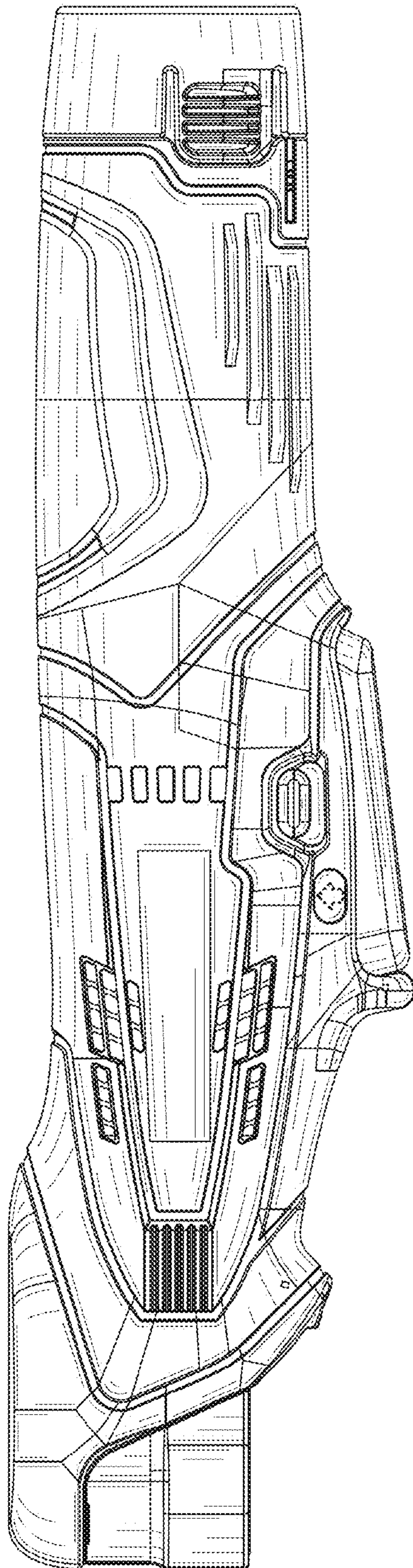

FIG. 3



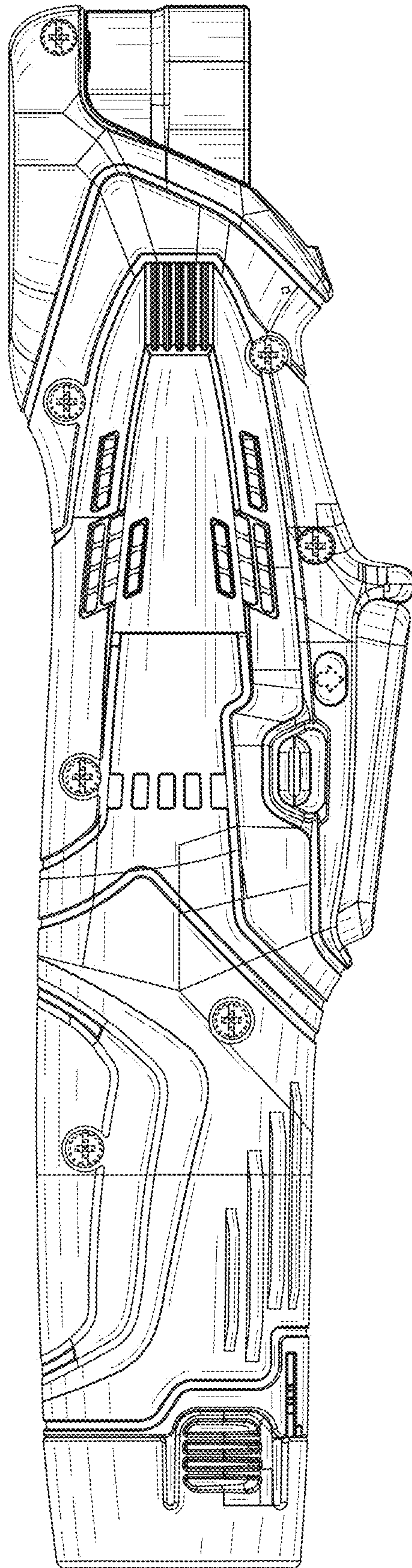

FIG. 4

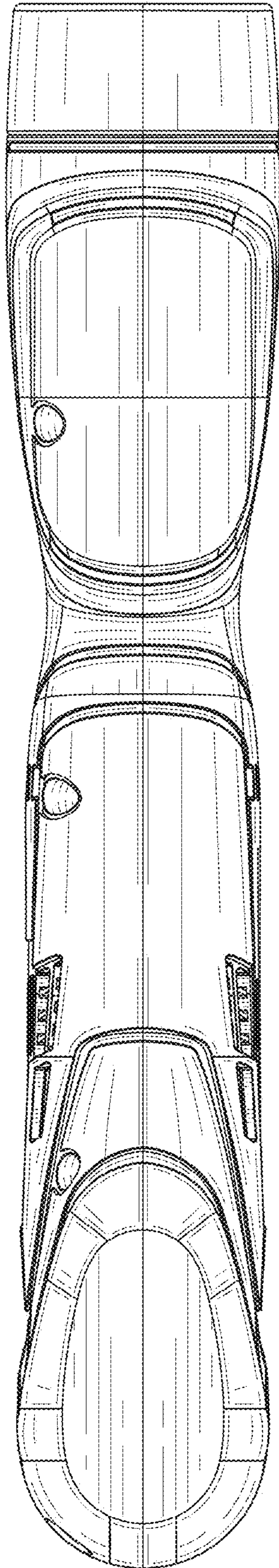

FIG. 5

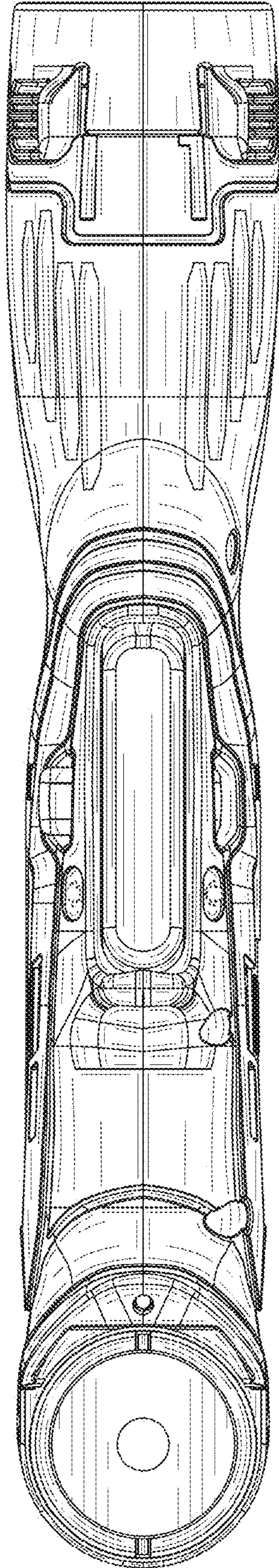
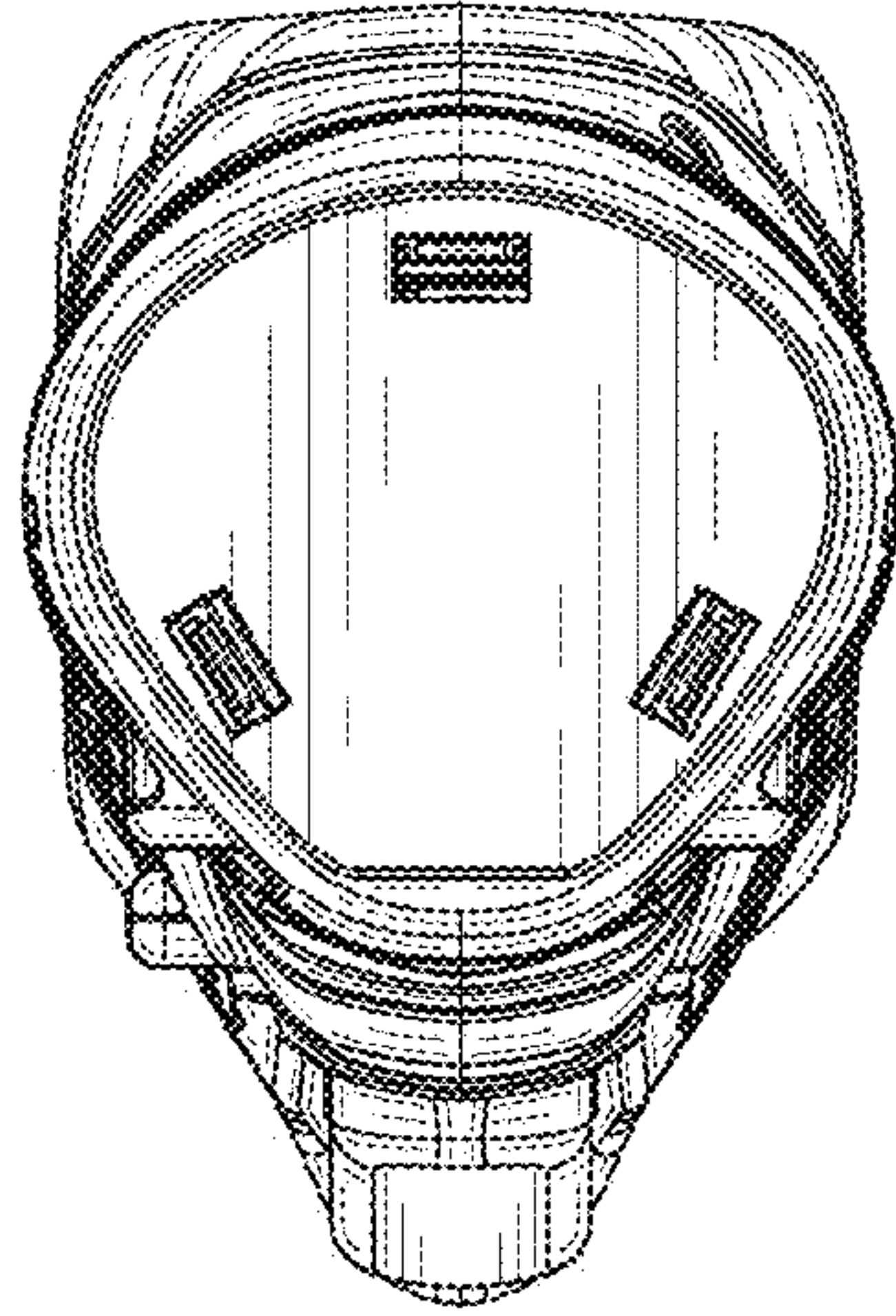
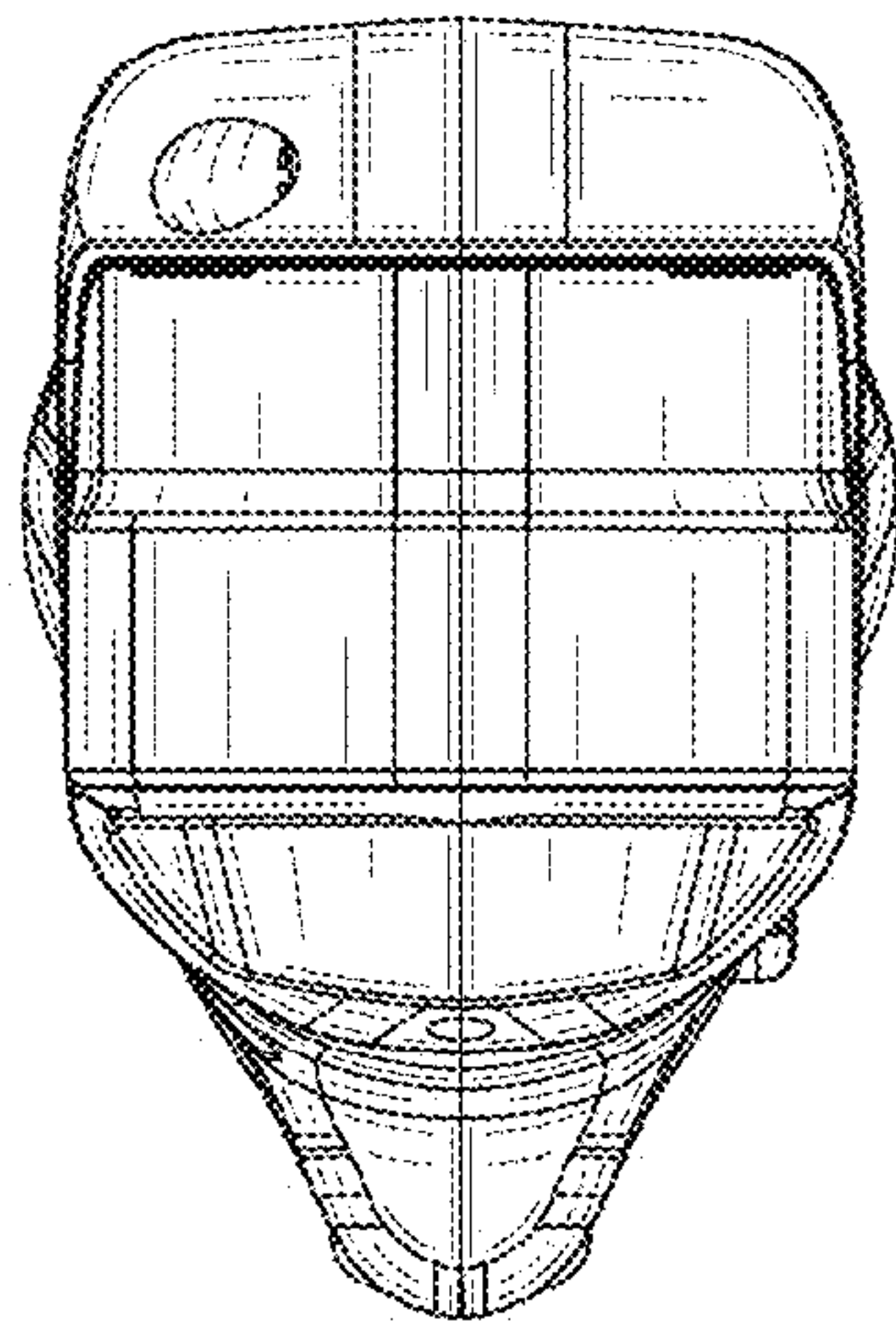

FIG. 6





**FIG. 7**



**FIG. 8**



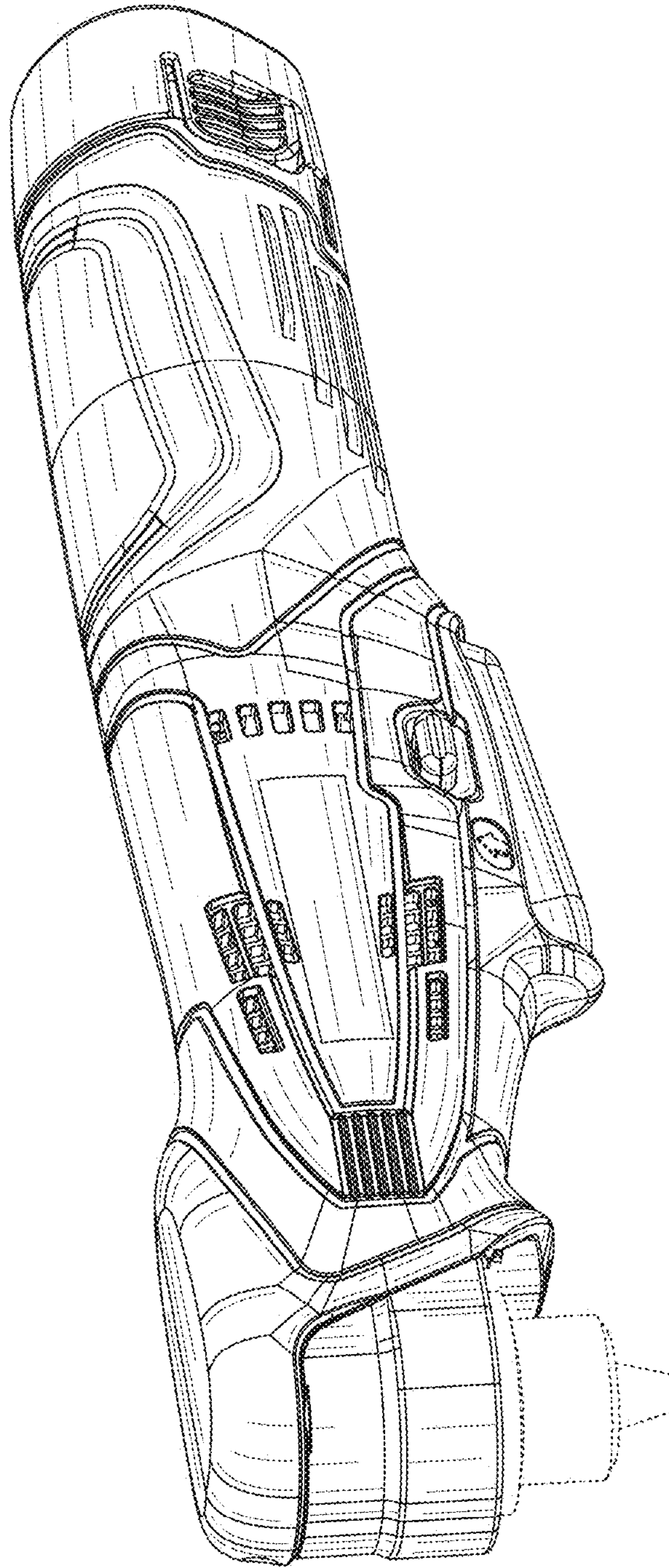

FIG. 9