



US00D689699S

(12) **United States Design Patent**
Xi et al.

(10) **Patent No.:** **US D689,699 S**

(45) **Date of Patent:** **** Sep. 17, 2013**

(54) **ORAL CARE IMPLEMENT**

(71) Applicant: **Colgate-Palmolive Company**, New York, NY (US)

(72) Inventors: **Wen Jin Xi**, Shanghai (CN); **Guang Sheng Guo**, Yangzhou (CN); **Kai Zhang**, Yangzhou (CN)

(73) Assignee: **Colgate-Palmolive Company**, New York, NY (US)

(**) Term: **14 Years**

(21) Appl. No.: **29/433,360**

(22) Filed: **Sep. 28, 2012**

(51) **LOC (9) Cl.** **04-02**

(52) **U.S. Cl.**
USPC **D4/104**

(58) **Field of Classification Search**
USPC D4/101, 104-112, 124-126, 132-134, D4/136, 138; 15/110, 143.1, 159.1, 160, 15/167.1, 167.2; 132/308-311; 601/139, 601/141, 142
See application file for complete search history.

(56) **References Cited**

U.S. PATENT DOCUMENTS

D276,005 S *	10/1984	Fido	D4/104
D386,905 S *	12/1997	Brady et al.	D4/104
D596,406 S *	7/2009	Xi	D4/104
D606,319 S *	12/2009	Xi	D4/104
D635,775 S *	4/2011	Kalbfeld et al.	D4/104
D664,359 S *	7/2012	Xi et al.	D4/104

FOREIGN PATENT DOCUMENTS

KR	30-0362027 S *	9/2004
KR	30-0394238 S *	10/2005
KR	30-0604903 S *	7/2011

OTHER PUBLICATIONS

CN 3434877D Registered Design, (Chen, Xinglong) Mar. 30, 2005, [online], [retrieved on Apr. 7, 2013] Retrieved from the State Intellectual Property Office's CNIPR Database using the Internet: <URL: http://www.cnipr.com>.*

CN 3505549D Registered Design, (Sheng, Dafang) Feb. 15, 2006, [online], [retrieved on Apr. 10, 2013] Retrieved from the State Intellectual Property Office's CNIPR Database using the Internet: <URL: http://www.cnipr.com>.*

(Continued)

Primary Examiner — Melanie H Tung

Assistant Examiner — Lavone D Tabor

(74) *Attorney, Agent, or Firm* — Ryan M. Flandro

(57) **CLAIM**

The ornamental design for an oral care implement, as shown and described.

DESCRIPTION

FIG. 1 is a right front perspective view of an oral care implement according to a first embodiment of the new design; FIG. 2 is a front view thereof; FIG. 3 is a rear view thereof; FIG. 4 is a left side view thereof; FIG. 5 is a right side view thereof; FIG. 6 is a top view thereof; FIG. 7 is a bottom view thereof; FIG. 8 is a right front perspective view of an oral care implement according to a second embodiment of the new design; FIG. 9 is a front view thereof; FIG. 10 is a rear view thereof; FIG. 11 is a left side view thereof; FIG. 12 is a right side view thereof; FIG. 13 is a top view thereof; and, FIG. 14 is a bottom view thereof.

1 Claim, 8 Drawing Sheets

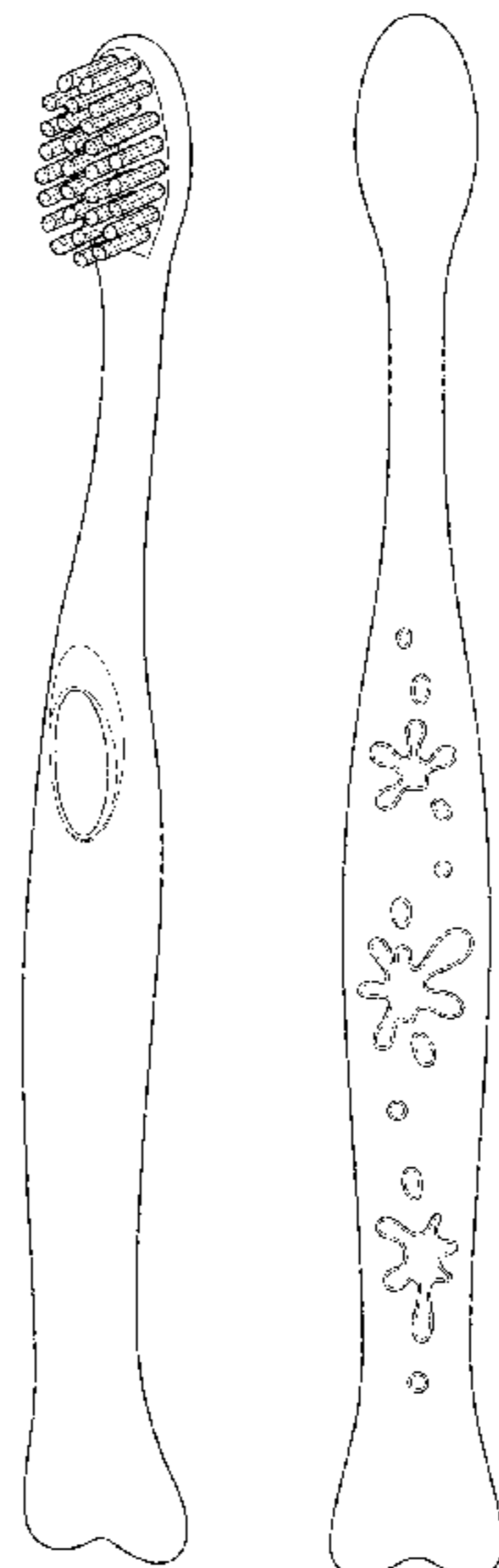

(56)

References Cited

OTHER PUBLICATIONS

CN 3521860D Registered Design, (Li, Wentong) Apr. 26, 2006, [online], [retrieved on Apr. 7, 2013] Retrieved from the State Intellectual Property Office's CNIPR Database using the Internet: <URL: <http://www.cnipr.com>>.*

CN 301548737 Registered Design, (Xu, Qiuping) May 18, 2011, [online], [retrieved on Apr. 7, 2013] Retrieved from the Questel Intellectual Property Portal Design Database using the Internet: <URL: <http://www.orbit.com>>.*

* cited by examiner

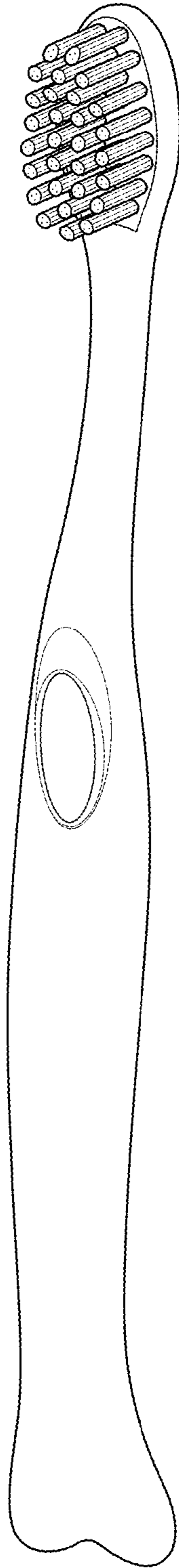

FIG. 1

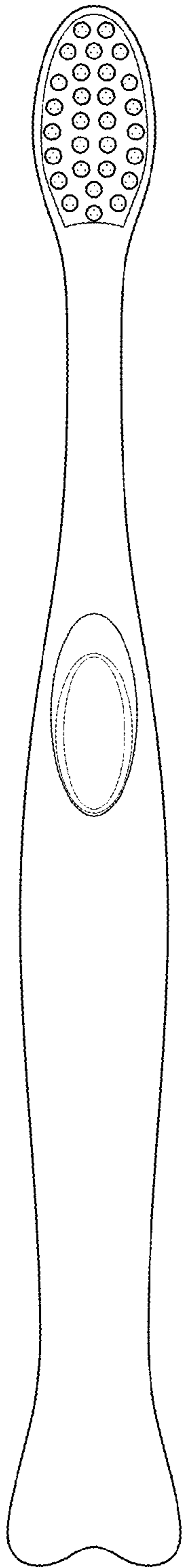

FIG. 2

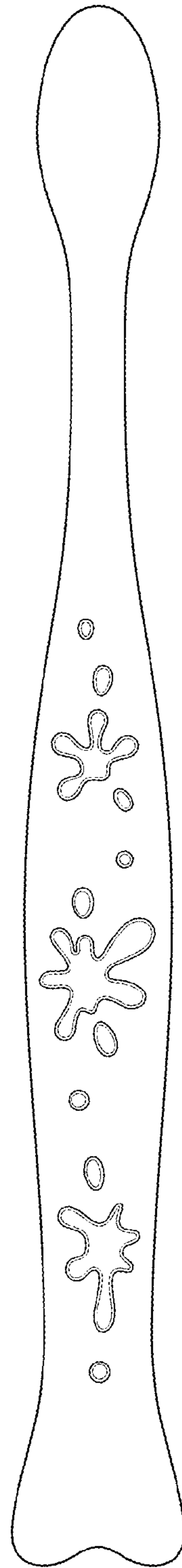

FIG. 3

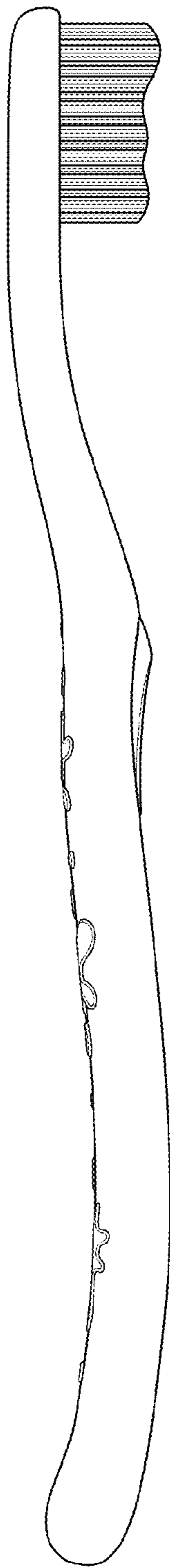

FIG. 4

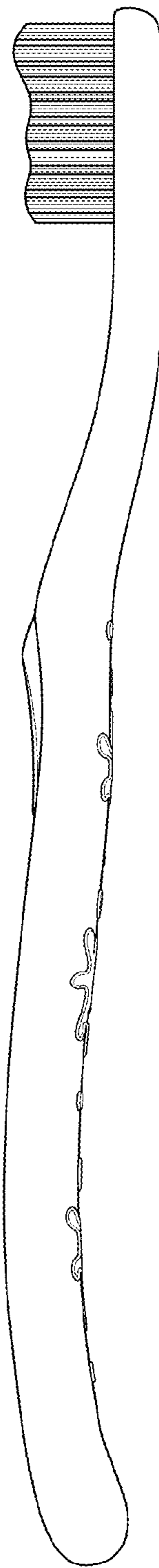

FIG. 5

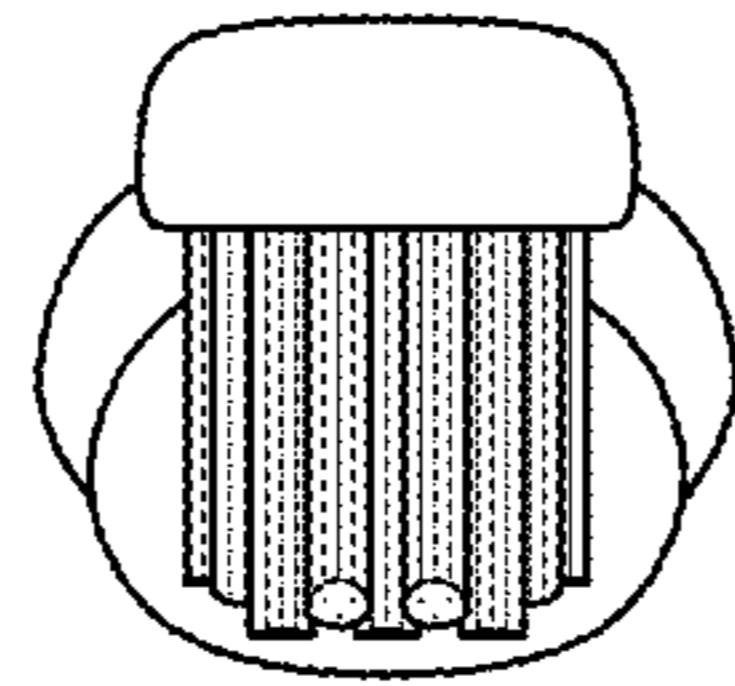

FIG. 6

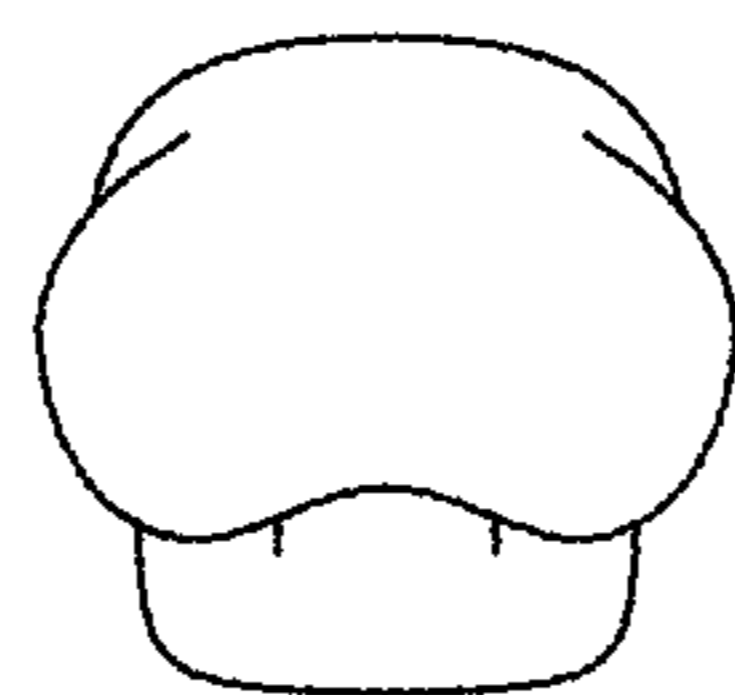

FIG. 7

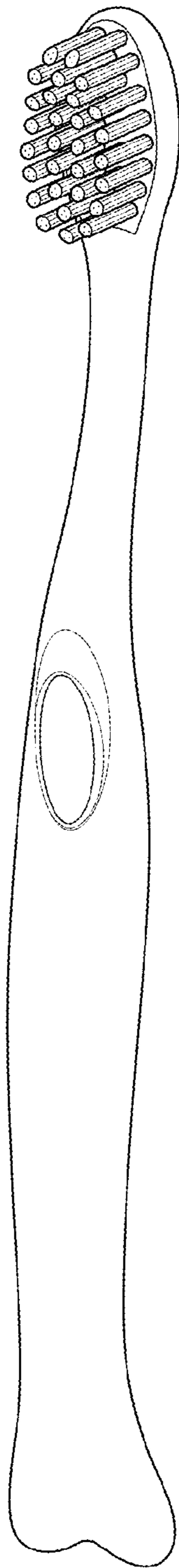

FIG. 8

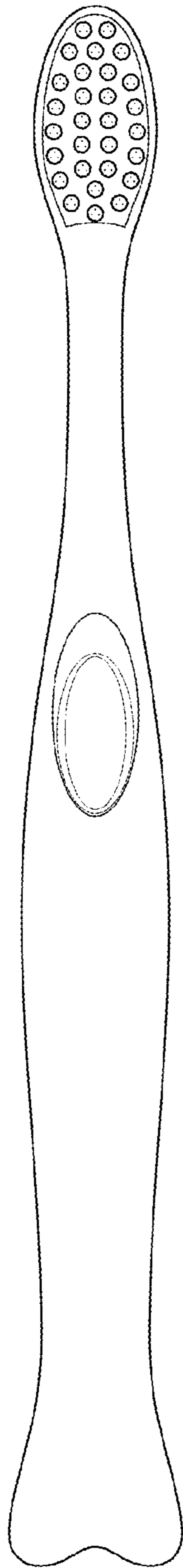

FIG. 9

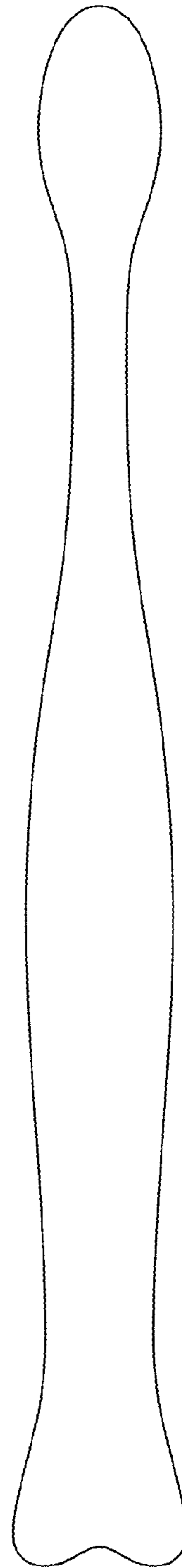

FIG. 10

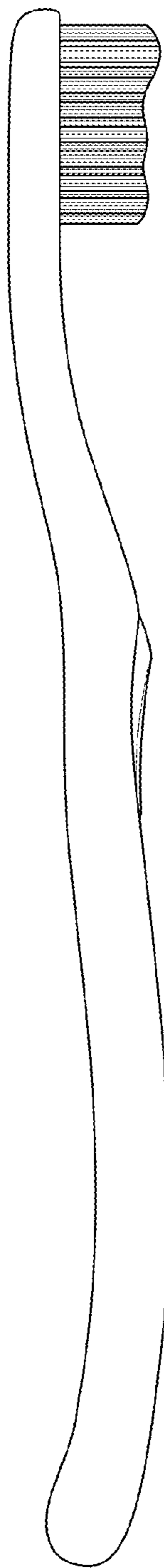

FIG. 11

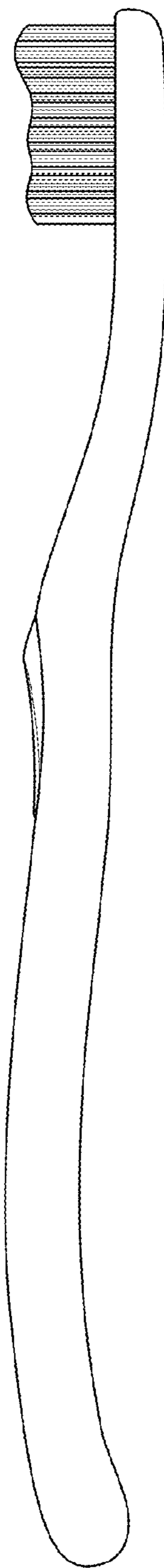

FIG. 12

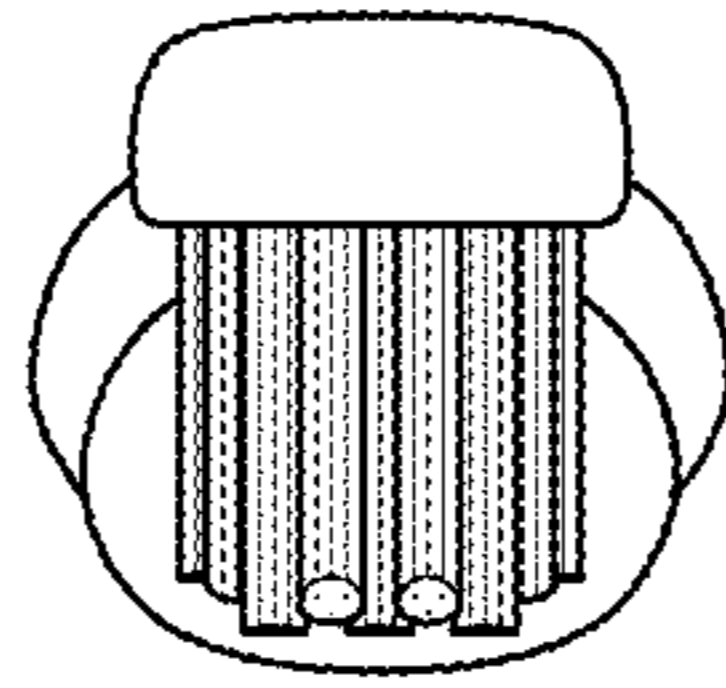

FIG. 13

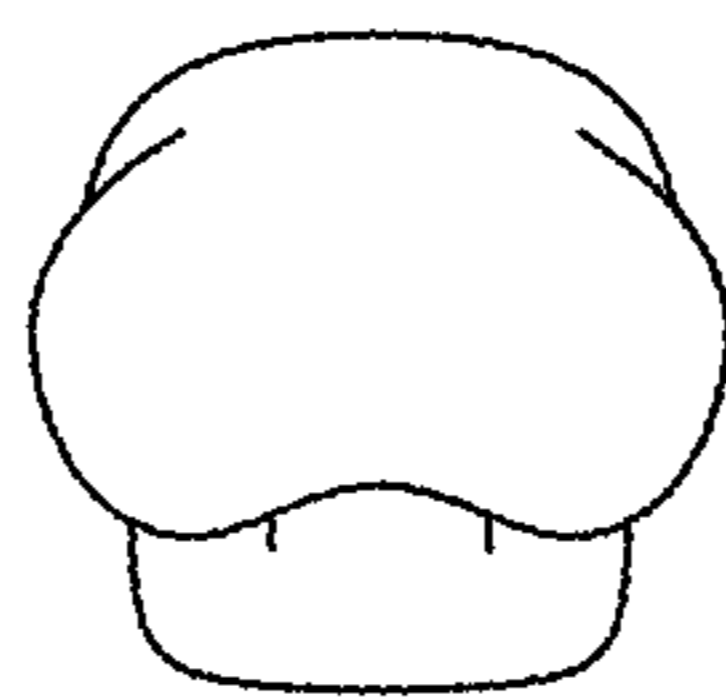

FIG. 14