

US00D689692S

(12) **United States Design Patent**  
**Jordan et al.**

(10) **Patent No.:** **US D689,692 S**

(45) **Date of Patent:** **\*\* Sep. 17, 2013**

(54) **MAGAZINE-SHAPED GUN CLEANING KIT**

(76) Inventors: **Trevor Aaron Jordan**, Humble, TX  
(US); **Peter Anthony Palma, III**, New  
Iberia, LA (US)

(\*\*) Term: **14 Years**

(21) Appl. No.: **29/426,685**

(22) Filed: **Jul. 9, 2012**

(51) **LOC (9) Cl.** ..... **03-01**

(52) **U.S. Cl.**

USPC ..... **D3/271.1**

(58) **Field of Classification Search**

USPC ..... D3/270, 271.1, 271.9, 273, 294,  
D3/901, 903, 904, 905; 42/94, 88, 51, 71.01,  
42/75.01, 90, 95; D22/108, 572, 573; 206/372,  
206/373

See application file for complete search history.

(56) **References Cited**

**U.S. PATENT DOCUMENTS**

856,016	A	6/1907	Balson	
2,744,275	A	5/1956	Geltner	
4,034,885	A	7/1977	Hunckler	
4,982,520	A	1/1991	Lee	
D412,786	S *	8/1999	Killinger	D3/273
6,012,246	A	1/2000	Robinson et al.	
D437,685	S *	2/2001	Liu	D3/294
D444,944	S *	7/2001	Smith et al.	D3/271.4
6,539,152	B1	3/2003	Wisz	
6,634,131	B1 *	10/2003	Fitzpatrick	42/90
6,640,480	B2	11/2003	Williams	
6,668,479	B1	12/2003	Obong	
6,779,289	B2	8/2004	Kay	
6,854,205	B2	2/2005	Wikle	
D540,539	S *	4/2007	Gutierrez	D3/269
7,261,029	B1 *	8/2007	Davis	89/148
7,506,137	B2	3/2009	Filicietti	

D595,053	S *	6/2009	Whitaker	D3/271.1
D600,669	S *	9/2009	Lewis	D14/142
D606,308	S *	12/2009	Cheng-Wei	D3/294
D620,545	S *	7/2010	Fitzpatrick et al.	D22/108
D633,590	S *	3/2011	Fitzpatrick et al.	D22/108
D637,682	S *	5/2011	Bentley et al.	D22/108
D637,813	S *	5/2011	Liang	D3/294
D639,052	S *	6/2011	Fathollahi	D3/269
D640,053	S *	6/2011	Voklel	D3/269
D676,239	S *	2/2013	Benoit et al.	D3/294
D676,655	S *	2/2013	Lin	D3/294
8,371,056	B1 *	2/2013	Baker et al.	42/90
D678,455	S *	3/2013	Hatfield	D22/108
2005/0000140	A1	1/2005	Wikle	
2009/0094875	A1 *	4/2009	Kim	42/1.02
2009/0193703	A1	8/2009	Riley	
2009/0282721	A1	11/2009	Confrey	
2010/0139144	A1	6/2010	Fitzpatrick et al.	
2010/0270201	A1	10/2010	Cauley et al.	
2011/0099872	A1	5/2011	Bentley et al.	

\* cited by examiner

*Primary Examiner* — Cynthia Ramirez

(74) *Attorney, Agent, or Firm* — nolaIP, LLC; Neil J. Coig

(57) **CLAIM**

The ornamental design for a magazine-shaped gun cleaning kit, as shown and described.

**DESCRIPTION**

FIG. 1 is a perspective view of a magazine-shaped gun cleaning kit showing our new design; FIG. 2 is a left side view thereof; FIG. 3 is a right side view thereof; FIG. 4 is a rear view thereof; FIG. 5 is a top view thereof; FIG. 6 is a bottom view thereof; and, FIG. 7 is a front view thereof.

**1 Claim, 3 Drawing Sheets**

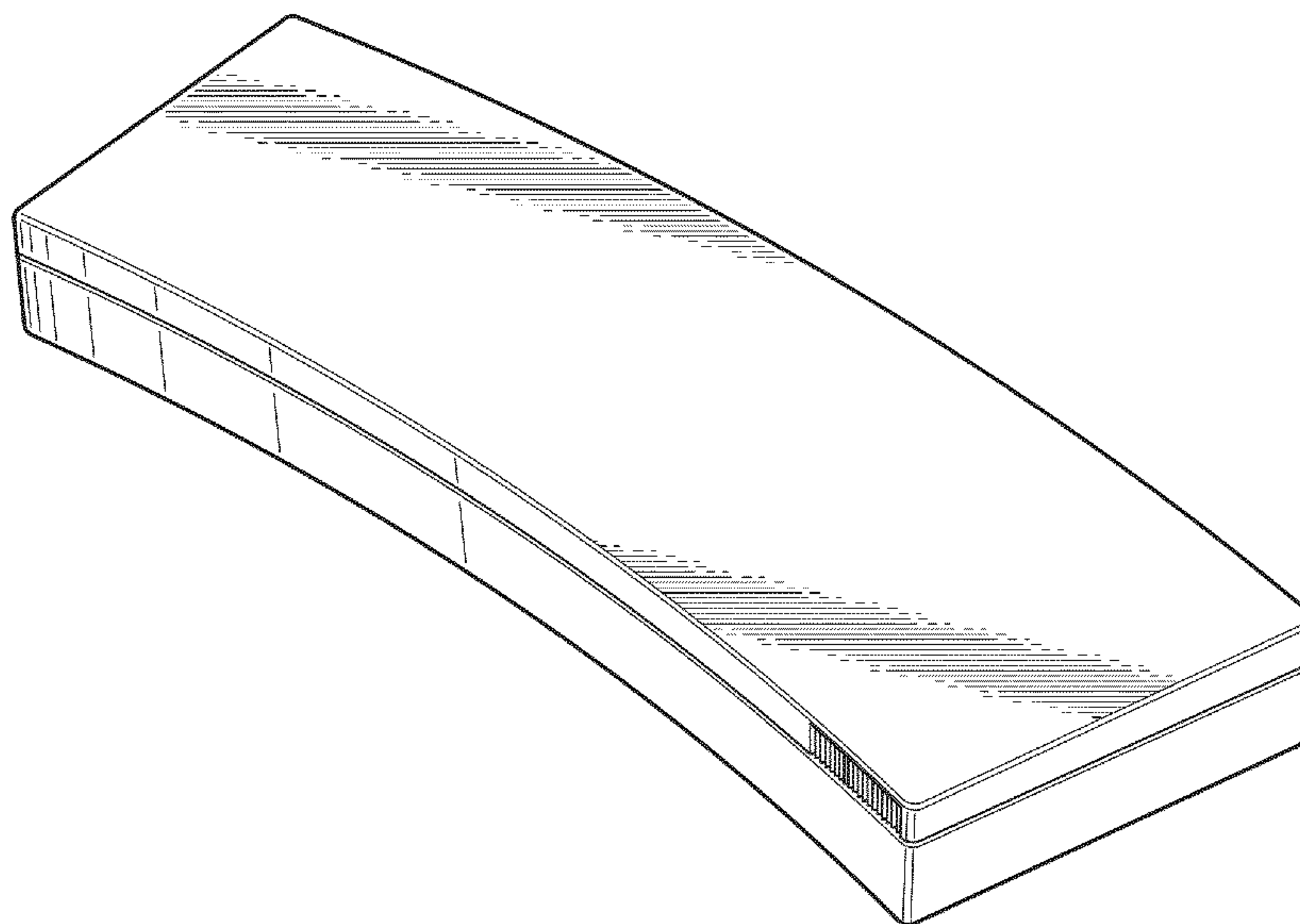

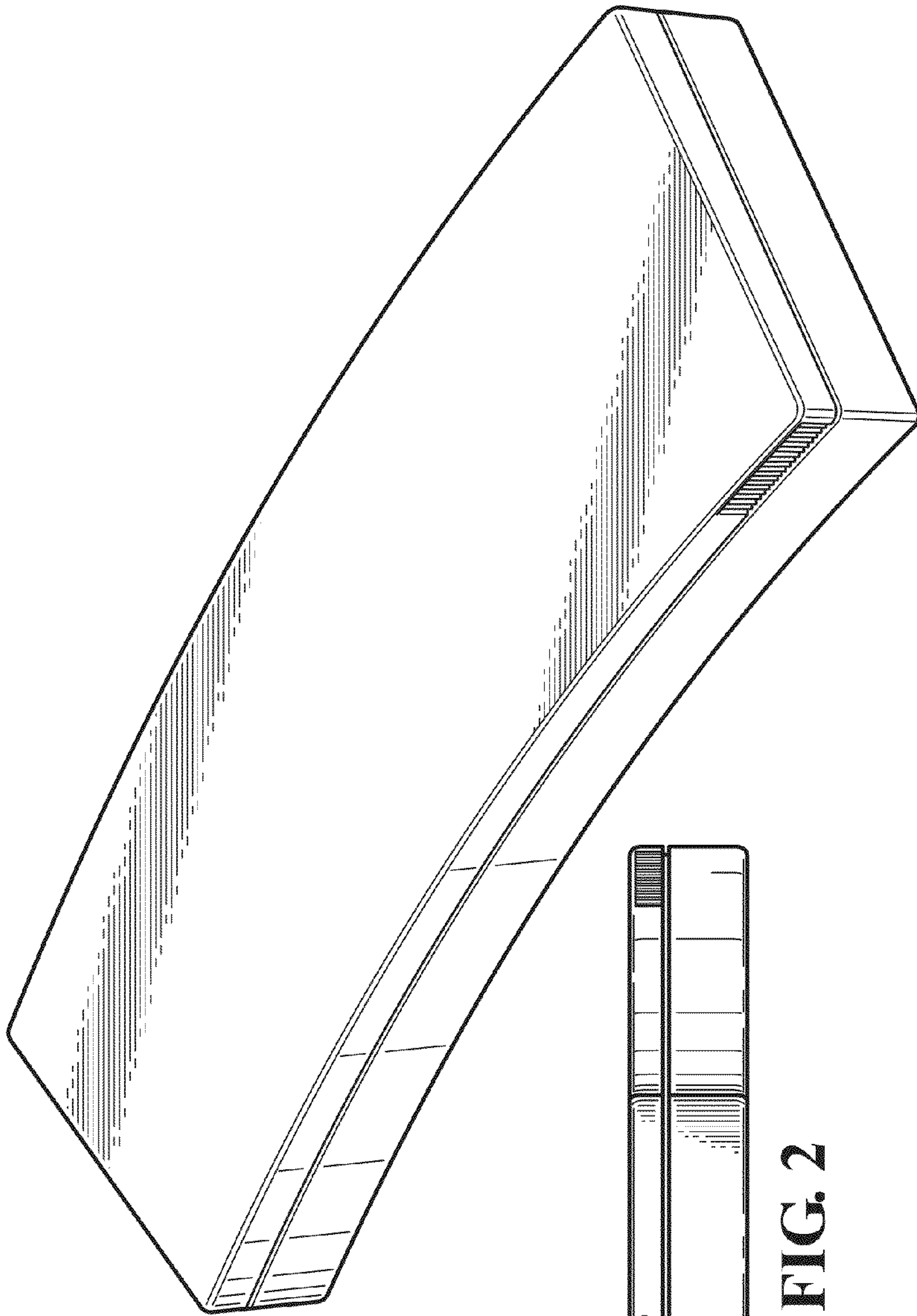

FIG. 1

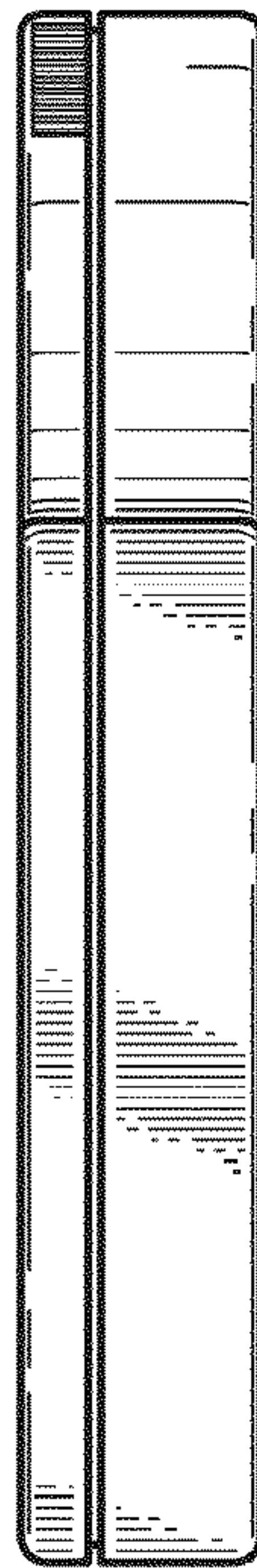

FIG. 2

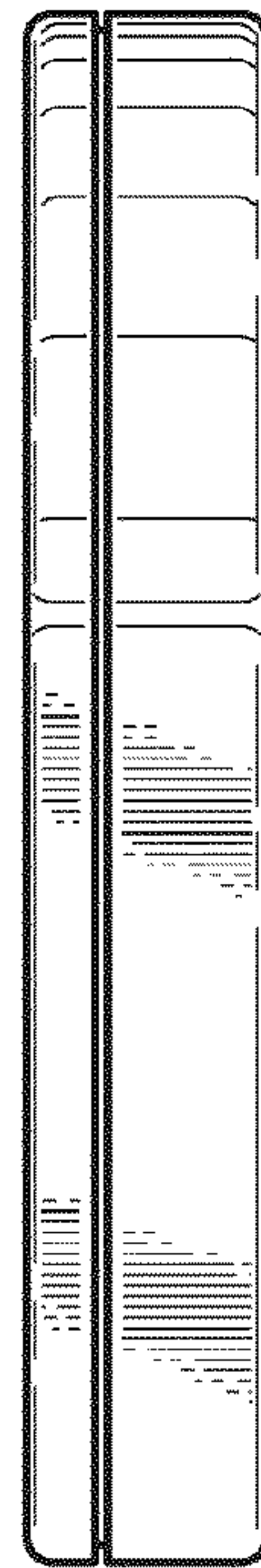

FIG. 3



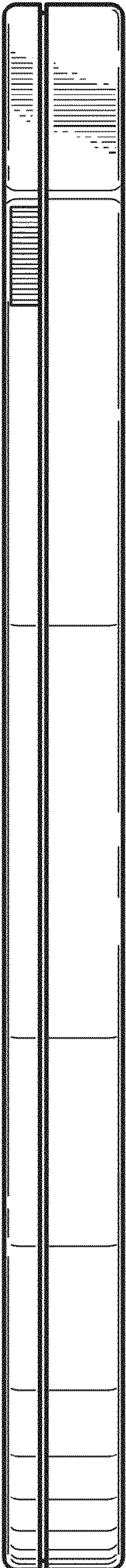

FIG. 4

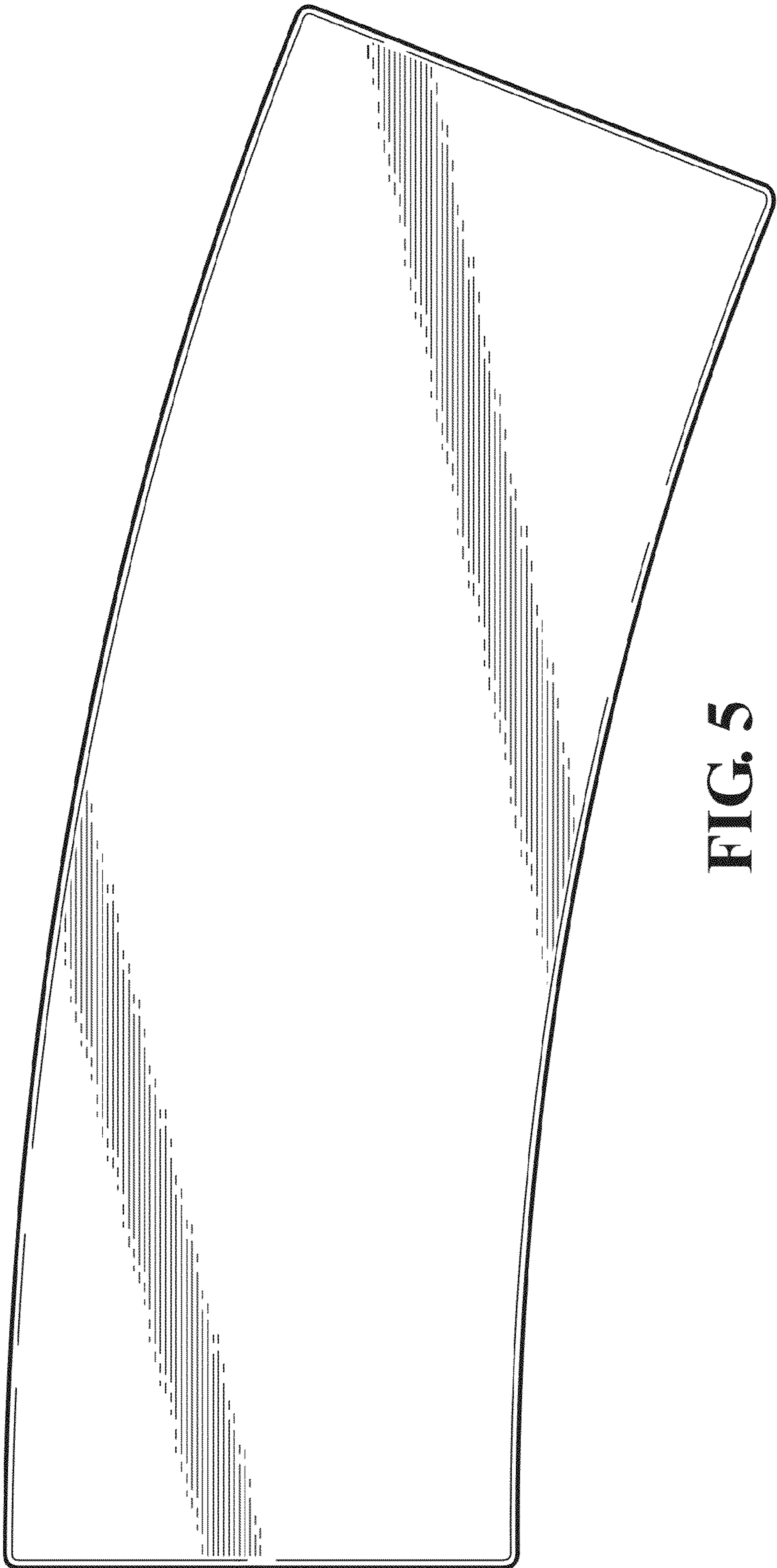

FIG. 5

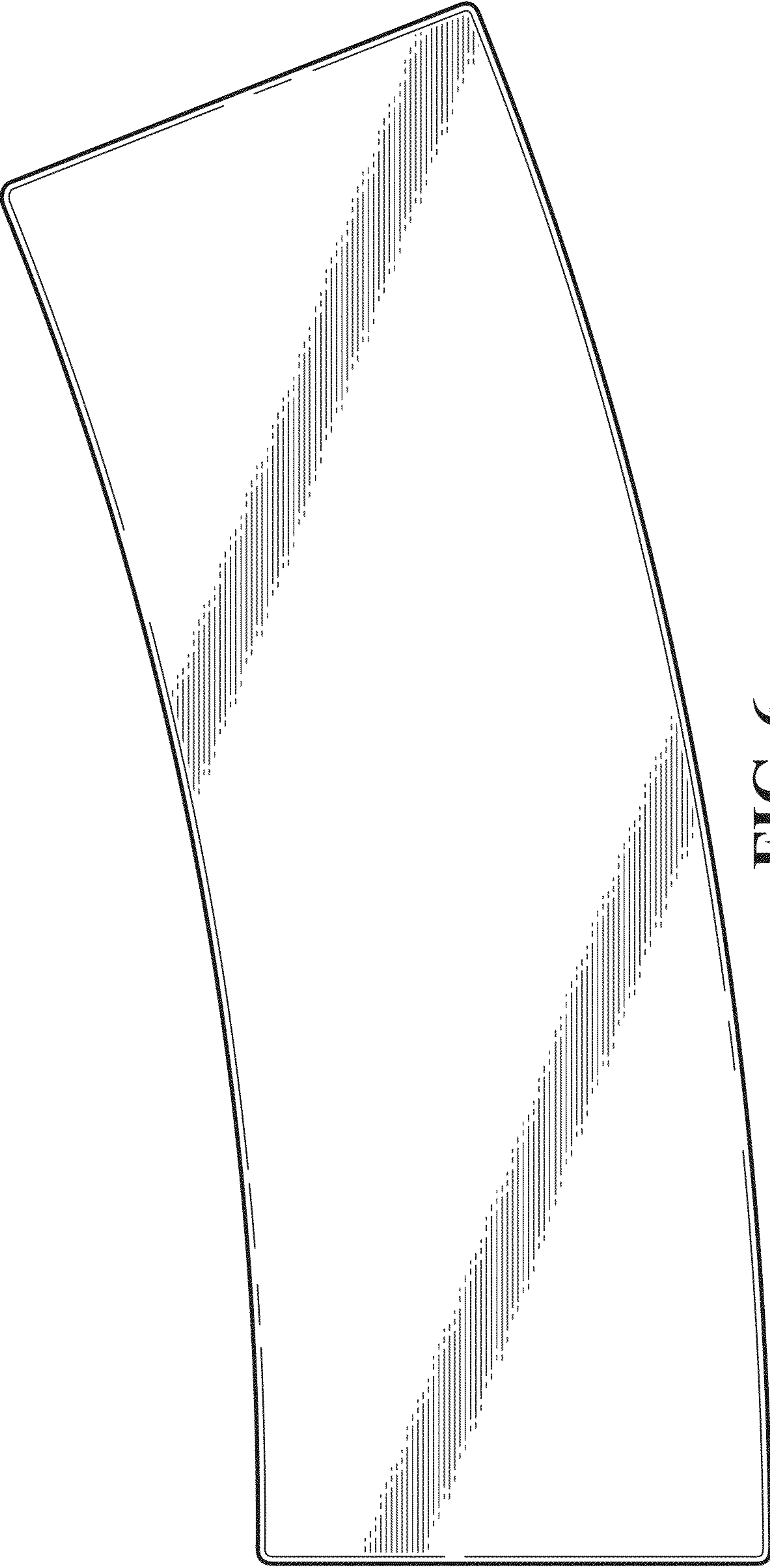

FIG. 6

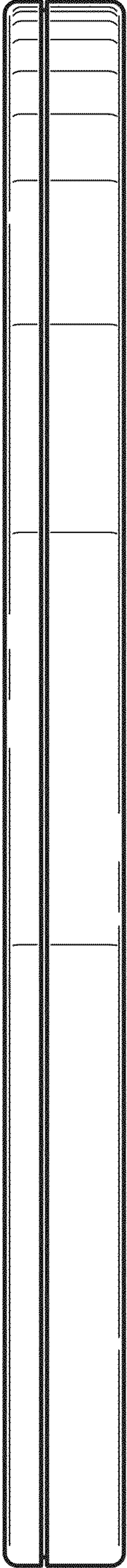

FIG. 7