



US00D689688S

(12) **United States Design Patent**
Horn

(10) **Patent No.:** **US D689,688 S**
(45) **Date of Patent:** **** Sep. 17, 2013**

(54) **PILL BOX WITH INDICIA AND WRITING INSTRUMENT HOLDER**

DESCRIPTION

- (71) Applicant: **Kimberlee Ann Horn**, Romney, IN (US)
- (72) Inventor: **Kimberlee Ann Horn**, Romney, IN (US)
- (**) Term: **14 Years**
- (21) Appl. No.: **29/444,256**
- (22) Filed: **Jan. 29, 2013**
- (51) **LOC (9) Cl.** **03-01**
- (52) **U.S. Cl.**
USPC **D3/203.2**
- (58) **Field of Classification Search**
USPC D3/203.1–203.7, 201, 205, 247–248;
206/528–540; D9/414–416, 420, 423–432
See application file for complete search history.

(56) **References Cited**

U.S. PATENT DOCUMENTS

D305,960 S *	2/1990	Wolff	D24/232
D514,308 S *	2/2006	Wahl et al.	D3/203.2
D585,638 S *	2/2009	Skedelius	D3/203.2
D606,393 S *	12/2009	Easterbrook et al.	D9/423
D652,204 S *	1/2012	Lindqvist et al.	D3/203.2

* cited by examiner

Primary Examiner — Catheri Oliver-Garcia

(74) *Attorney, Agent, or Firm* — James Ray & Assoc

(57) **CLAIM**

The ornamental design for a pill box with indicia and writing instrument holder, as shown.

FIG. 1 is a perspective view of a pill box showing my new design.

FIG. 2 is a perspective view of the open pill box in FIG. 1.

FIG. 3 is a bottom plan view of the open pill box in FIG. 1;

FIG. 4 is a right side elevation view of the pill box in FIG. 1.

FIG. 5 is a top plan view of the pill box in FIG. 1.

FIG. 6 is a left side elevation view of the pill box in FIG. 1.

FIG. 7 is a right side elevation view of the open pill box in FIG. 2;

FIG. 8 is an inside front elevation view of the open pill box in FIG. 2;

FIG. 9 is a left side elevation view of the open pill box in FIG. 2;

FIG. 10 is an outside top view of the open pill box in FIG. 2;

FIG. 11 is a perspective view of another embodiment of the open pill box.

FIG. 12 is a right side elevation view of the open pill box in FIG. 11;

FIG. 13 is an inside front elevation view of the open pill box in FIG. 11;

FIG. 14 is a left side elevation view of the open pill box in FIG. 11; and,

FIG. 15 is an outside top view of the open pill box in FIG. 11.

The bottom view of the second embodiment is the same as the bottom view of the first embodiment.

The broken line showing of environment in the drawings is included for the purpose of illustrating only and forms no part of the claimed design.

1 Claim, 5 Drawing Sheets

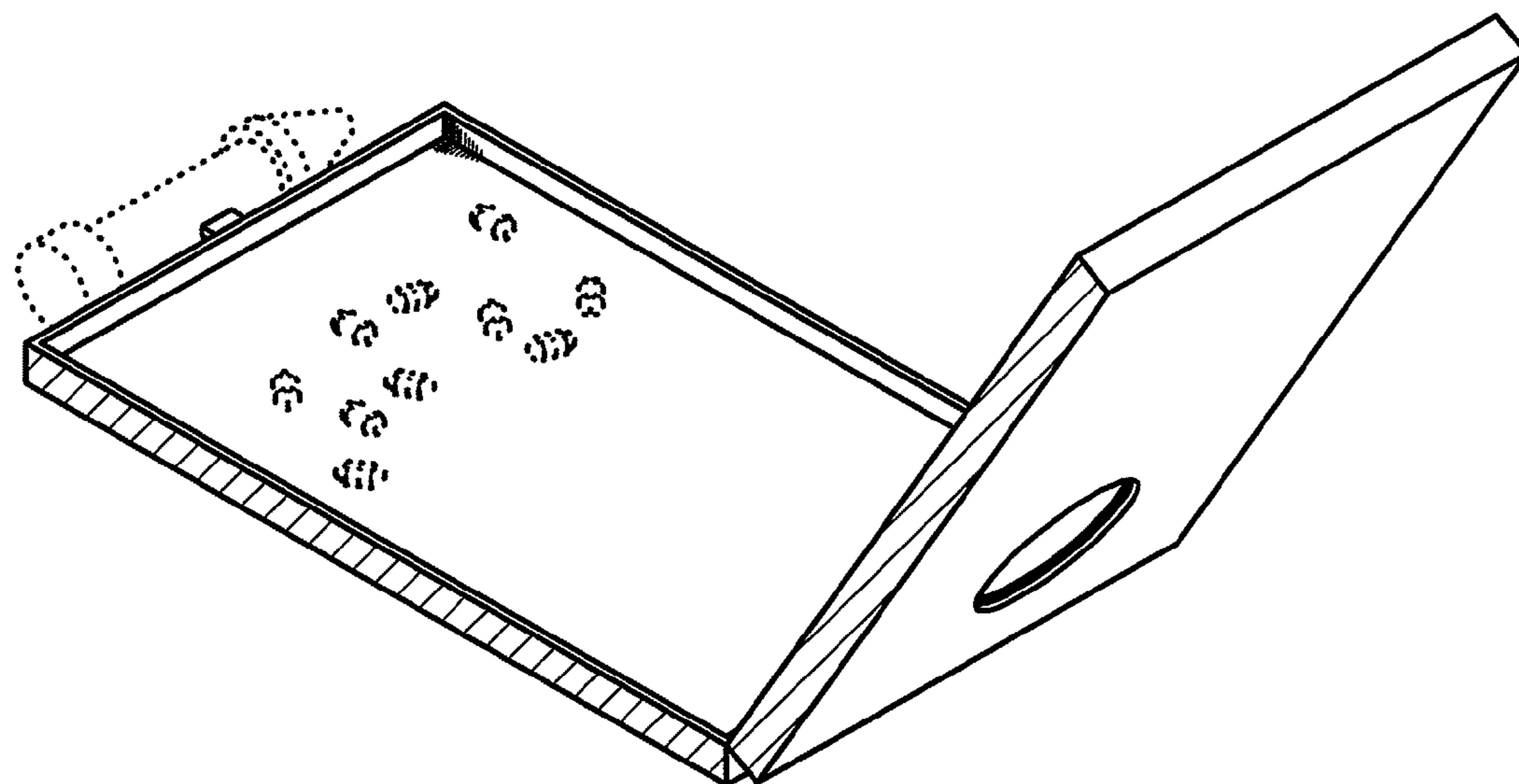

Fig. 1

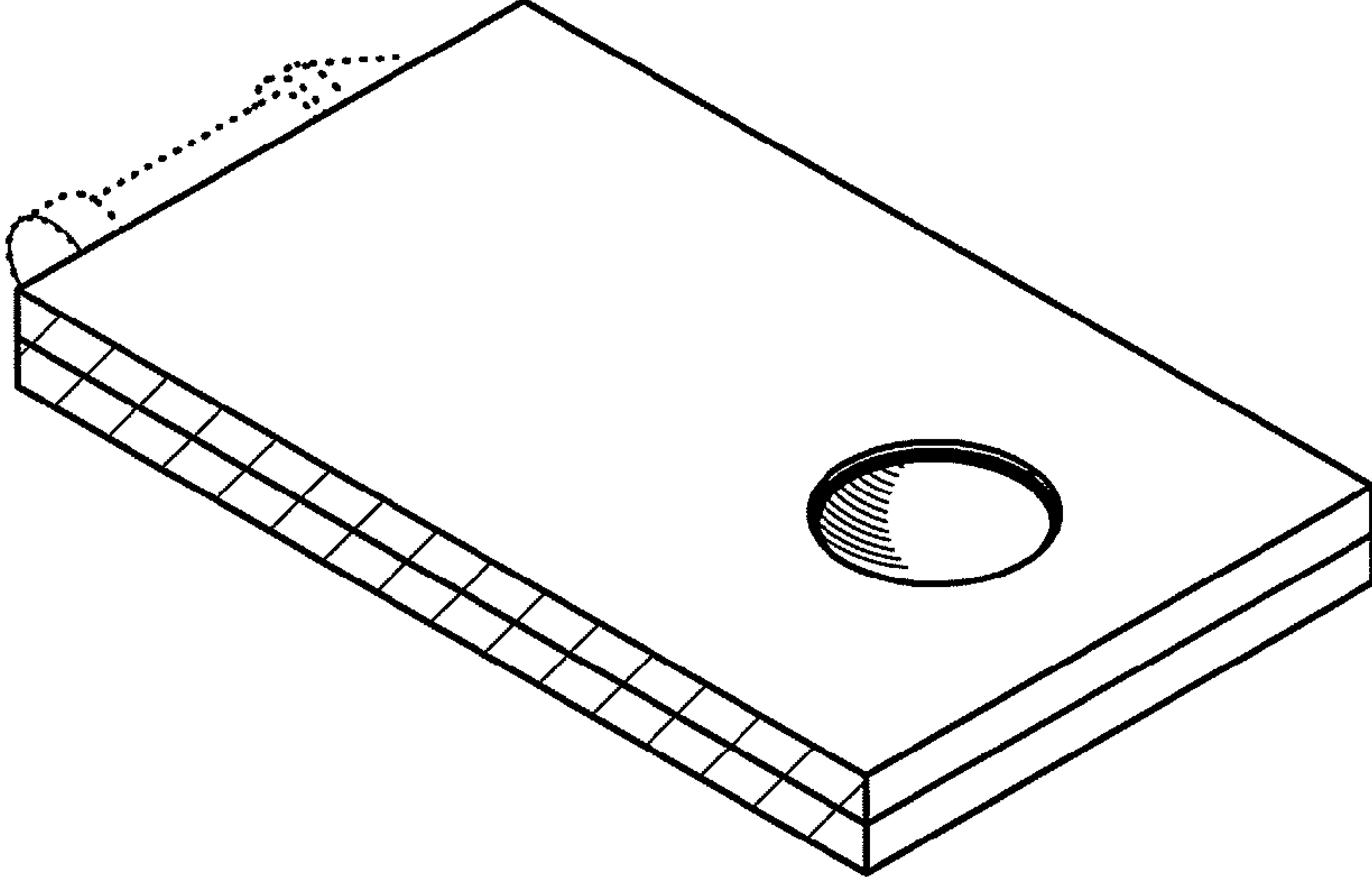

Fig. 2

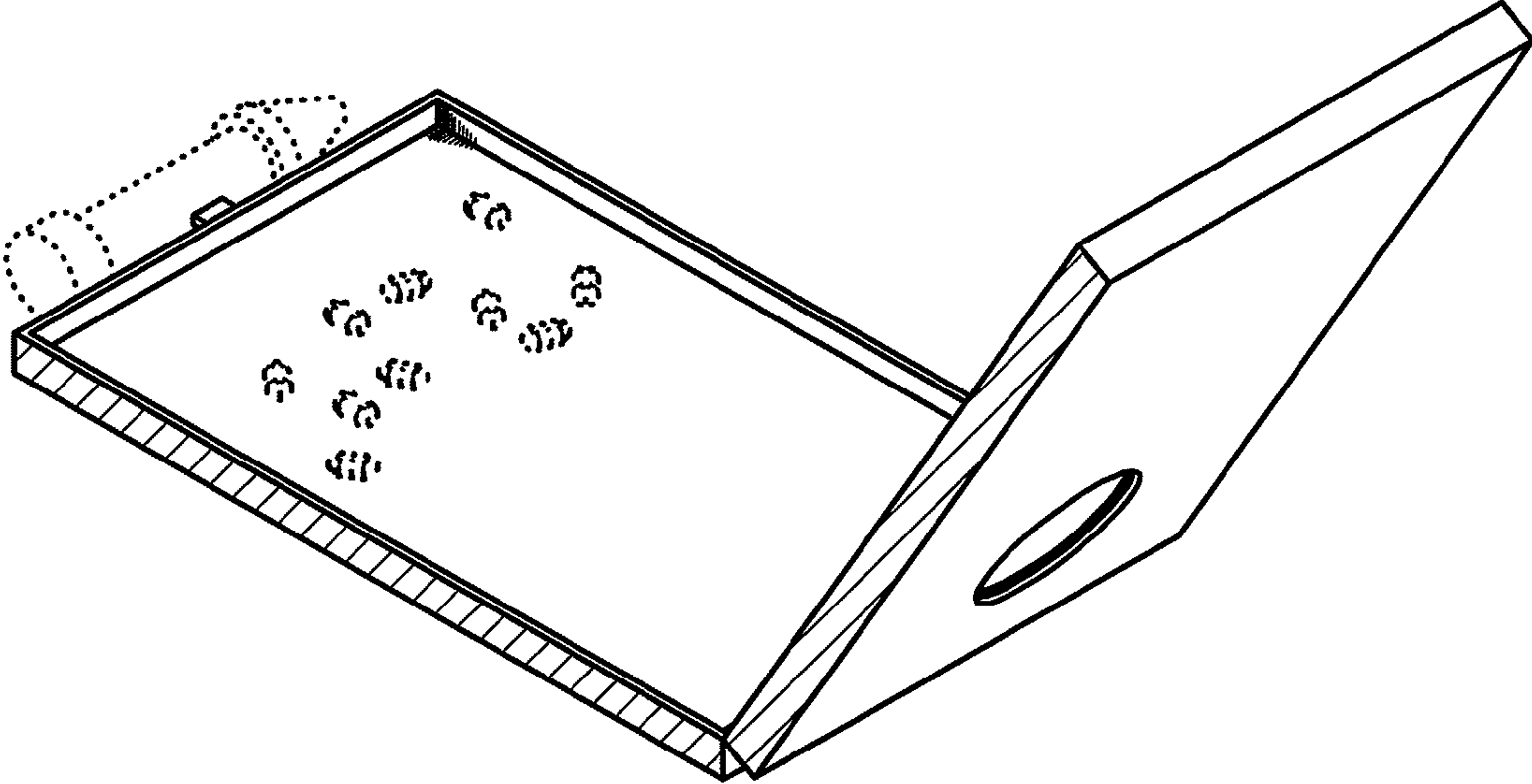

Fig. 3

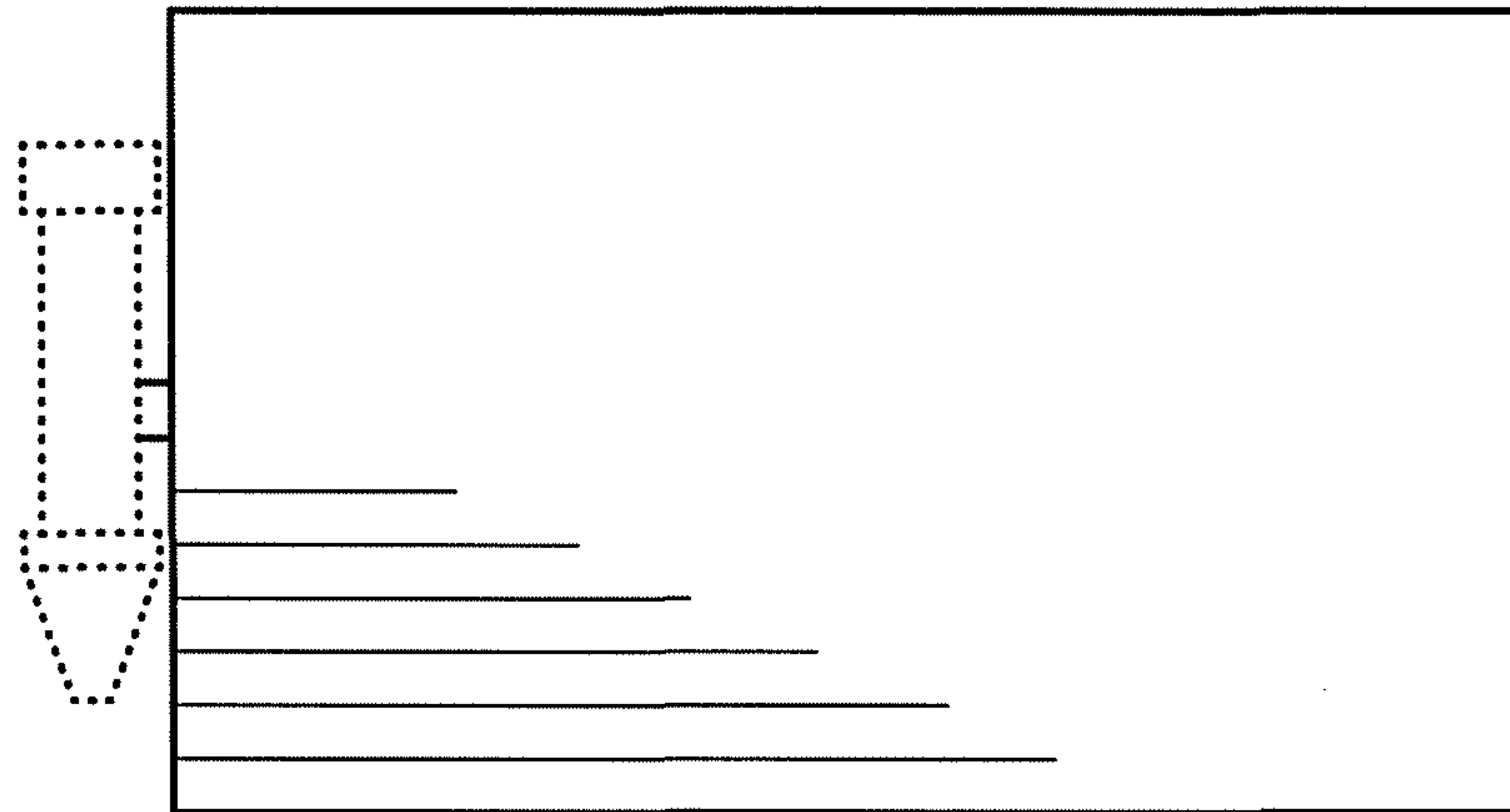

Fig. 4



Fig. 5

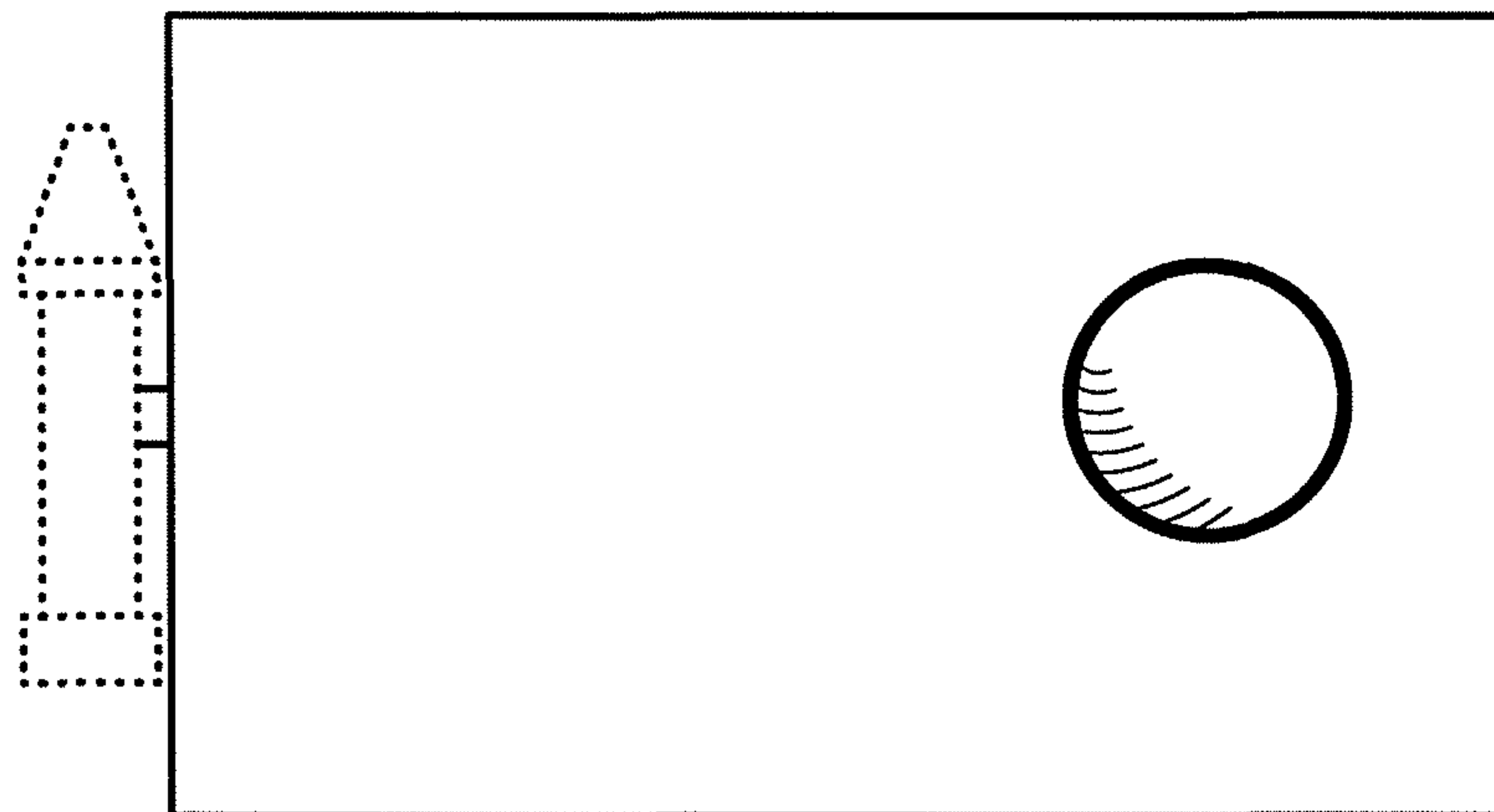

Fig. 6



Fig. 7

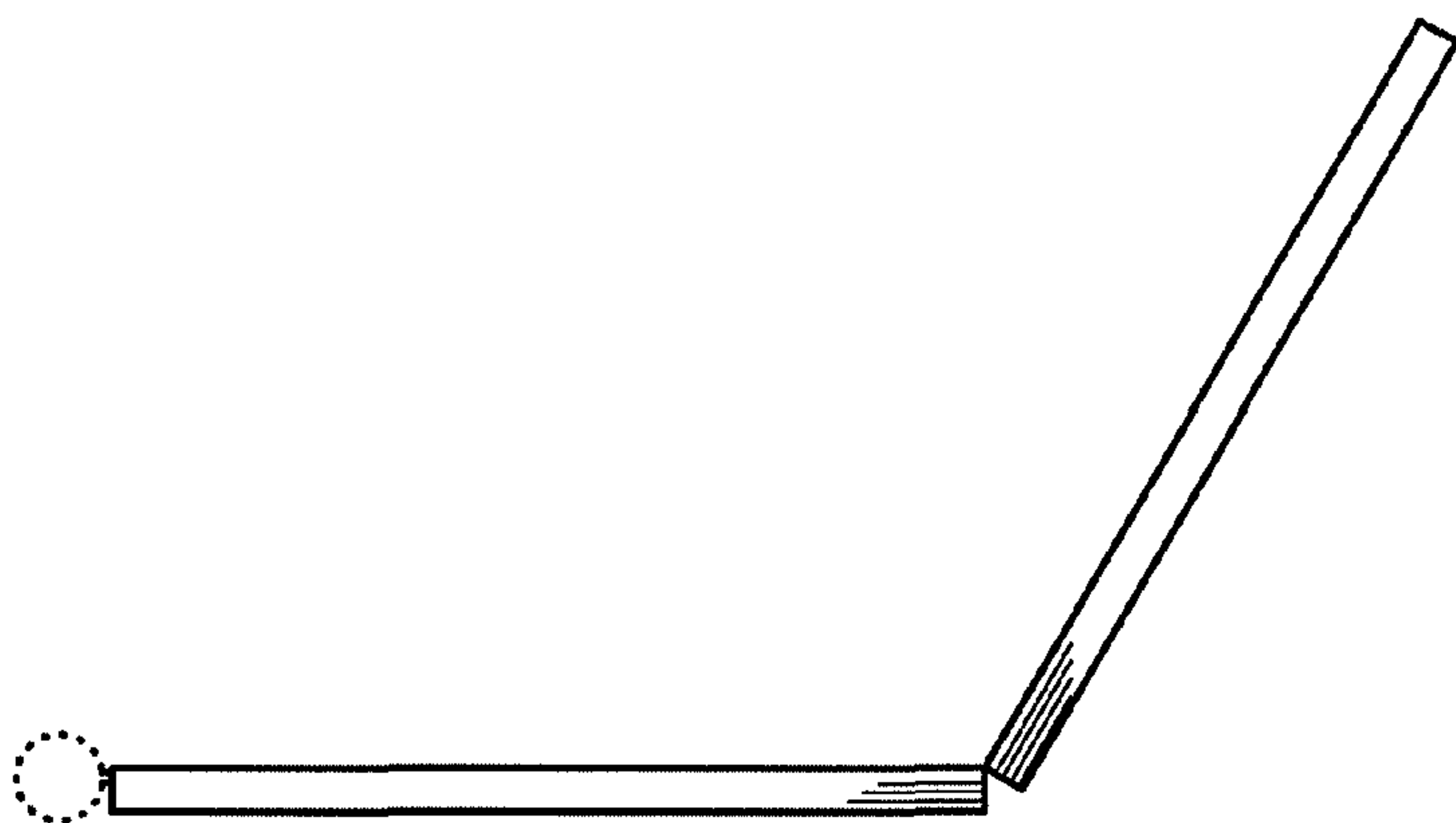

Fig. 8

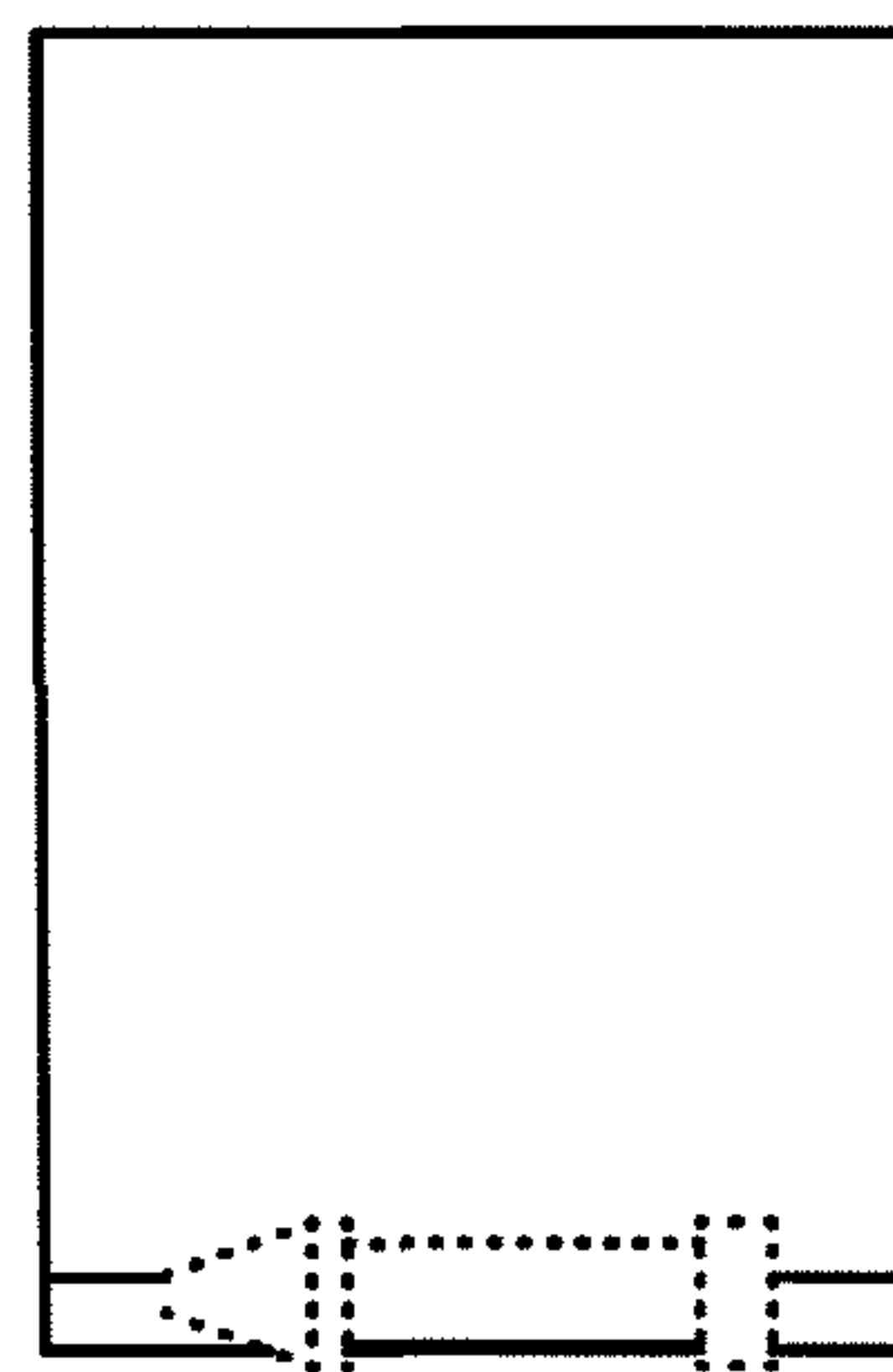

Fig. 9

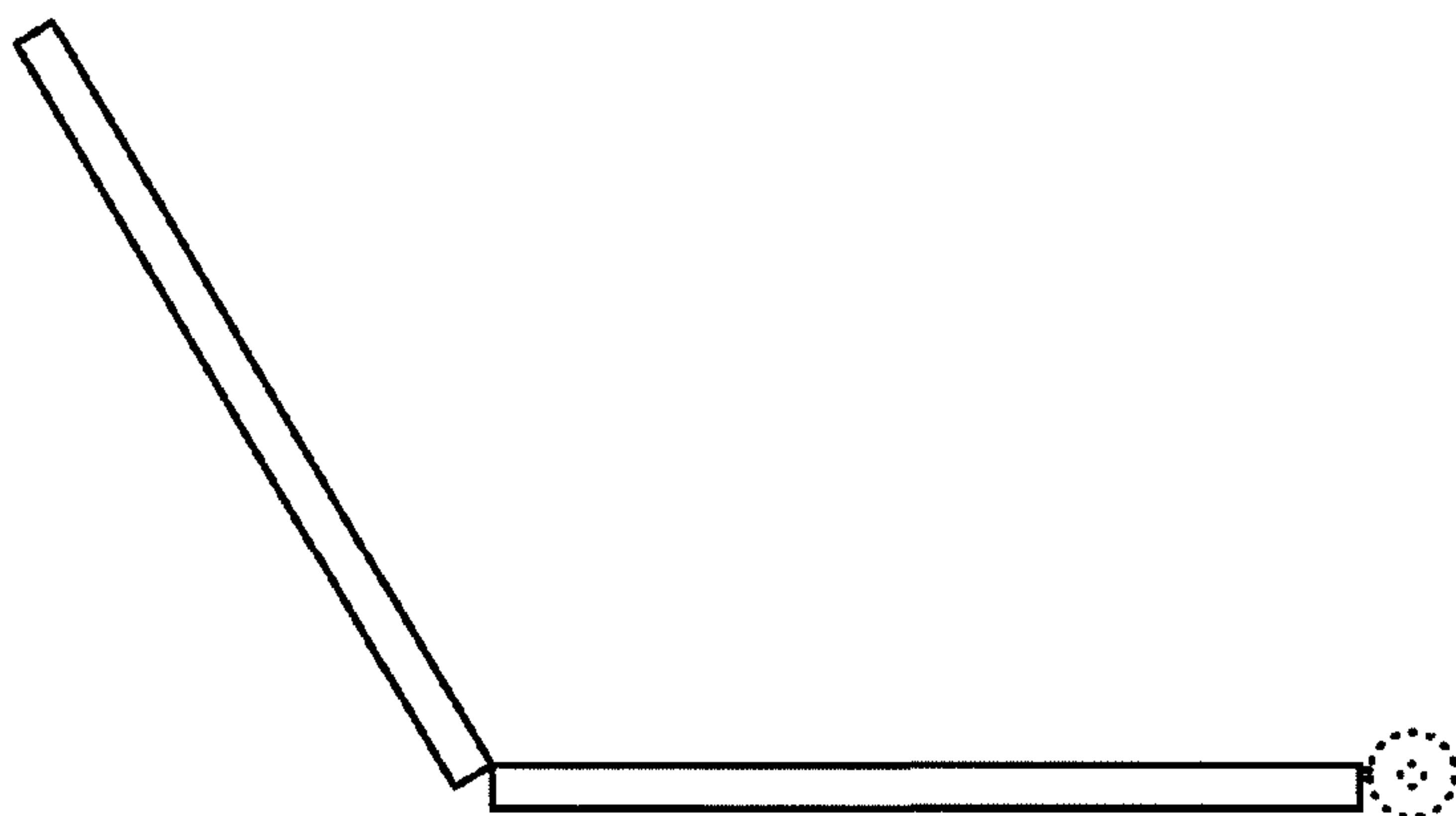

Fig. 10

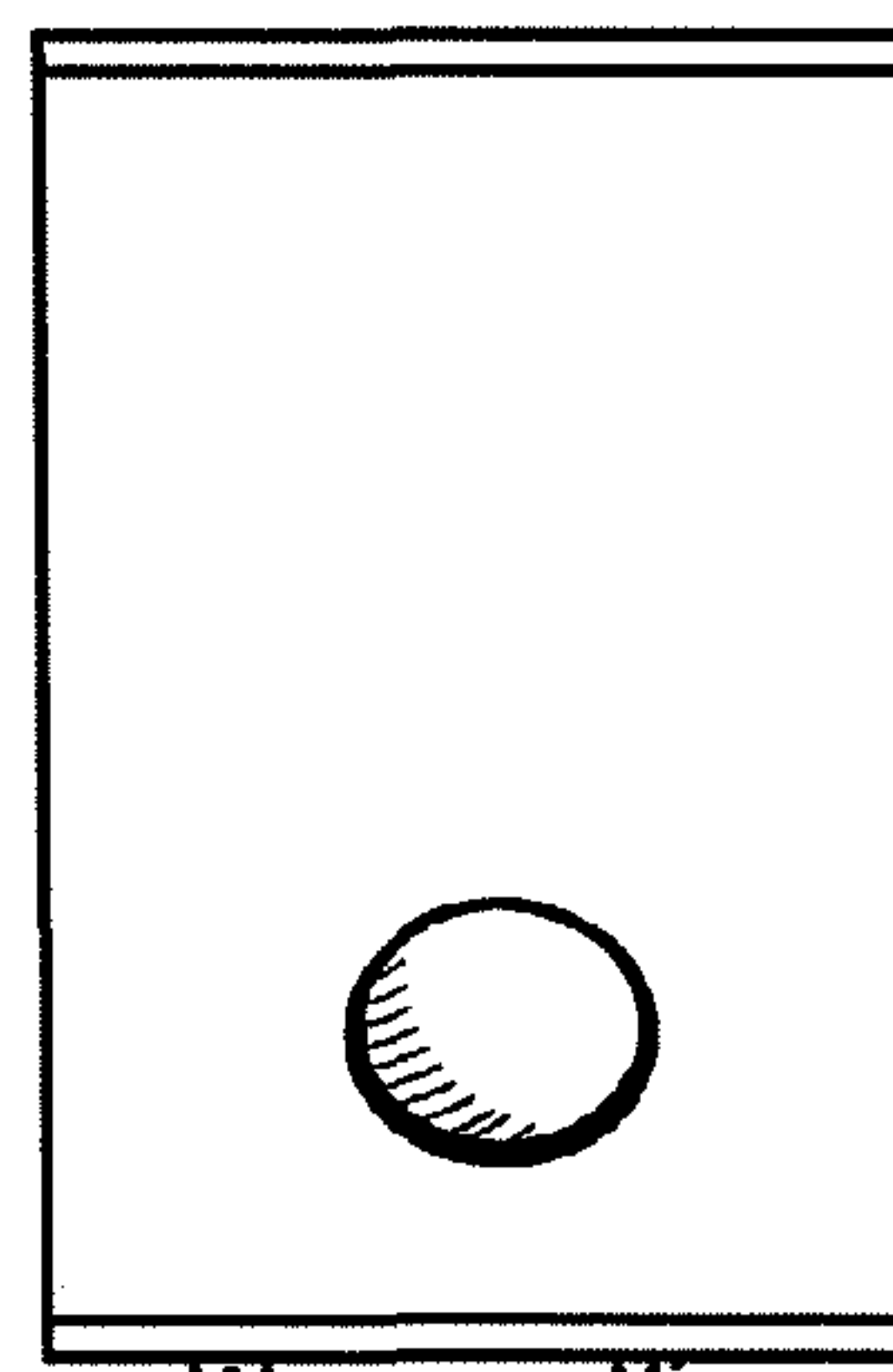

Fig. 11

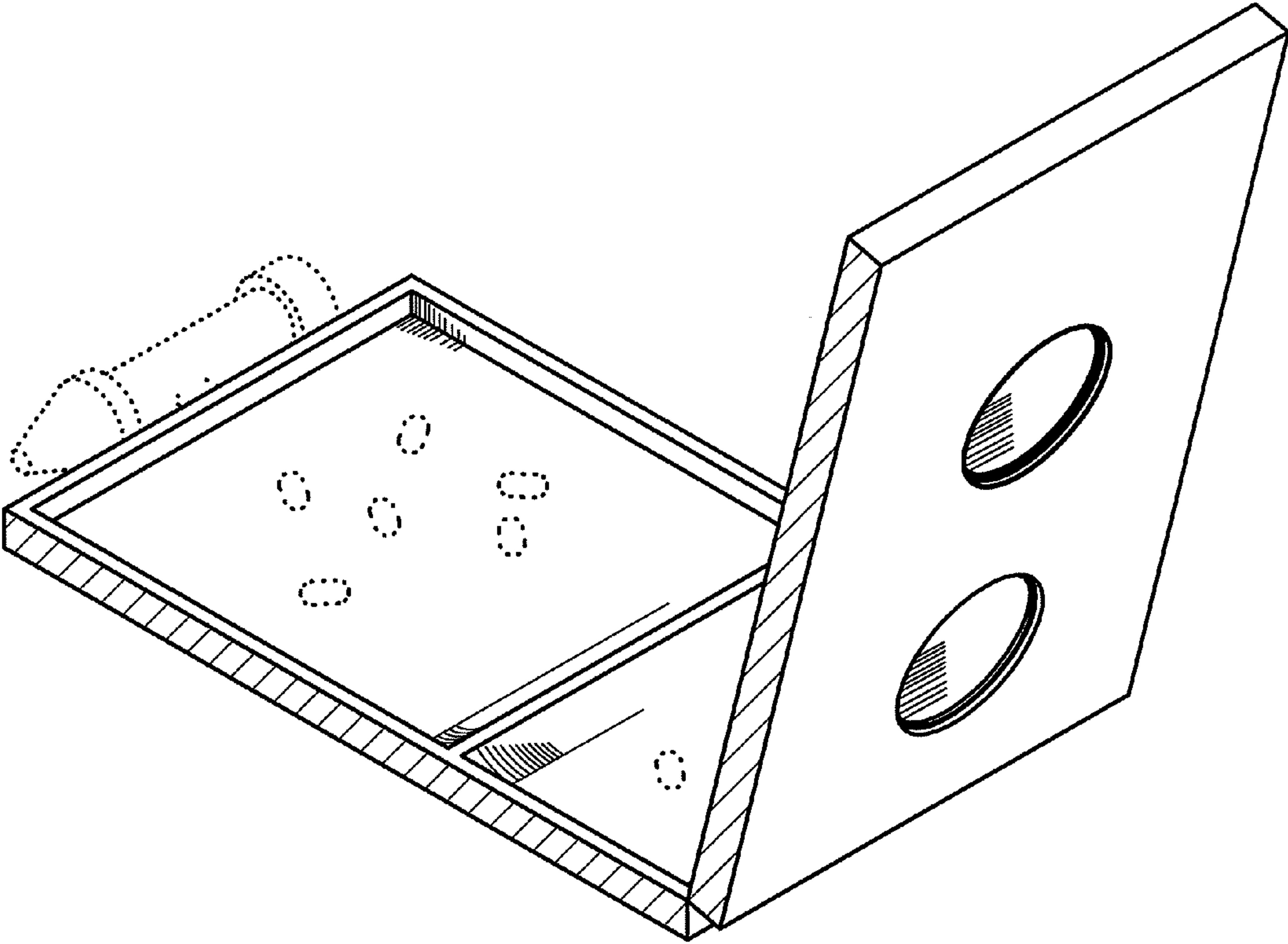

Fig. 12

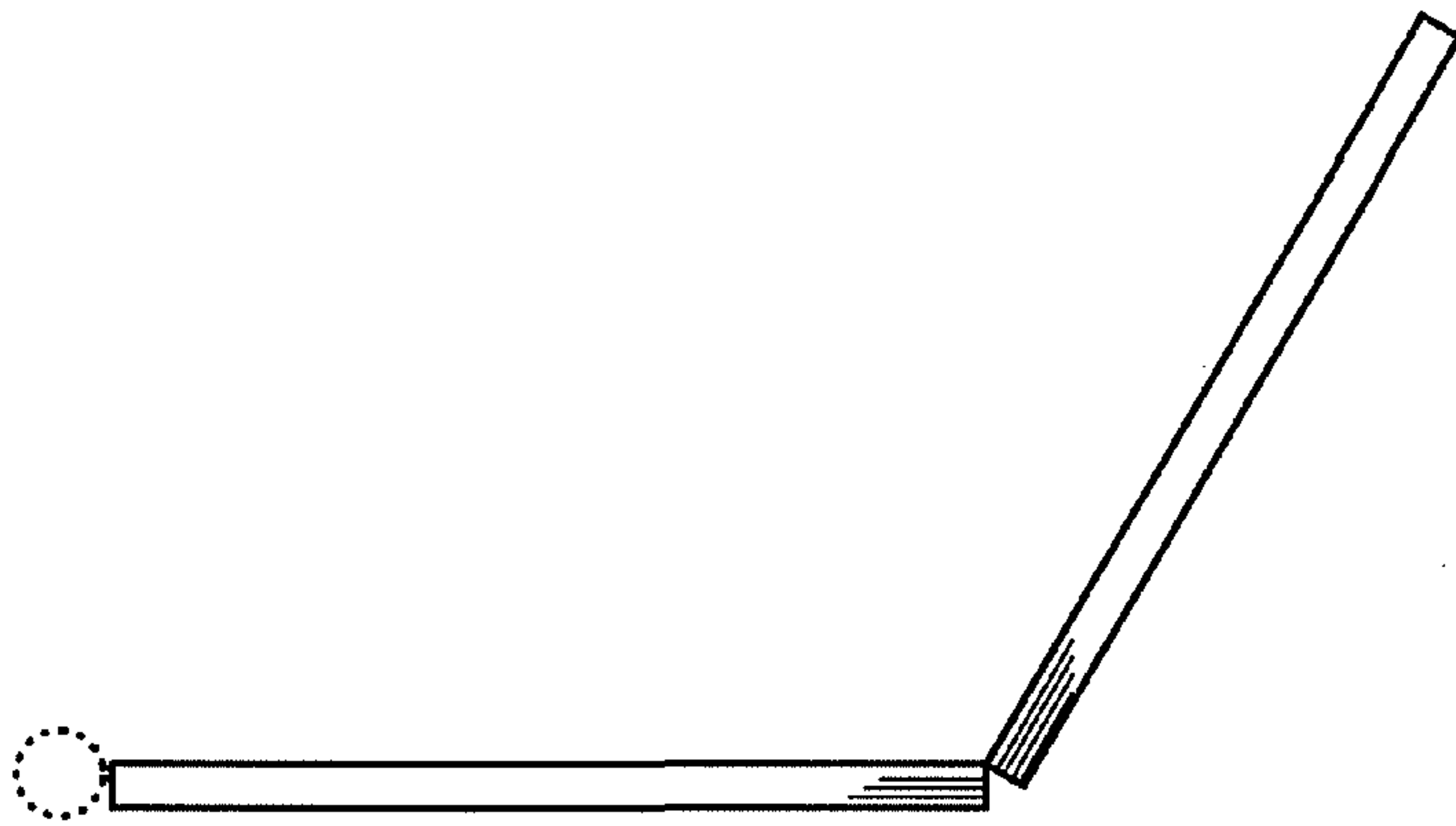

Fig. 13

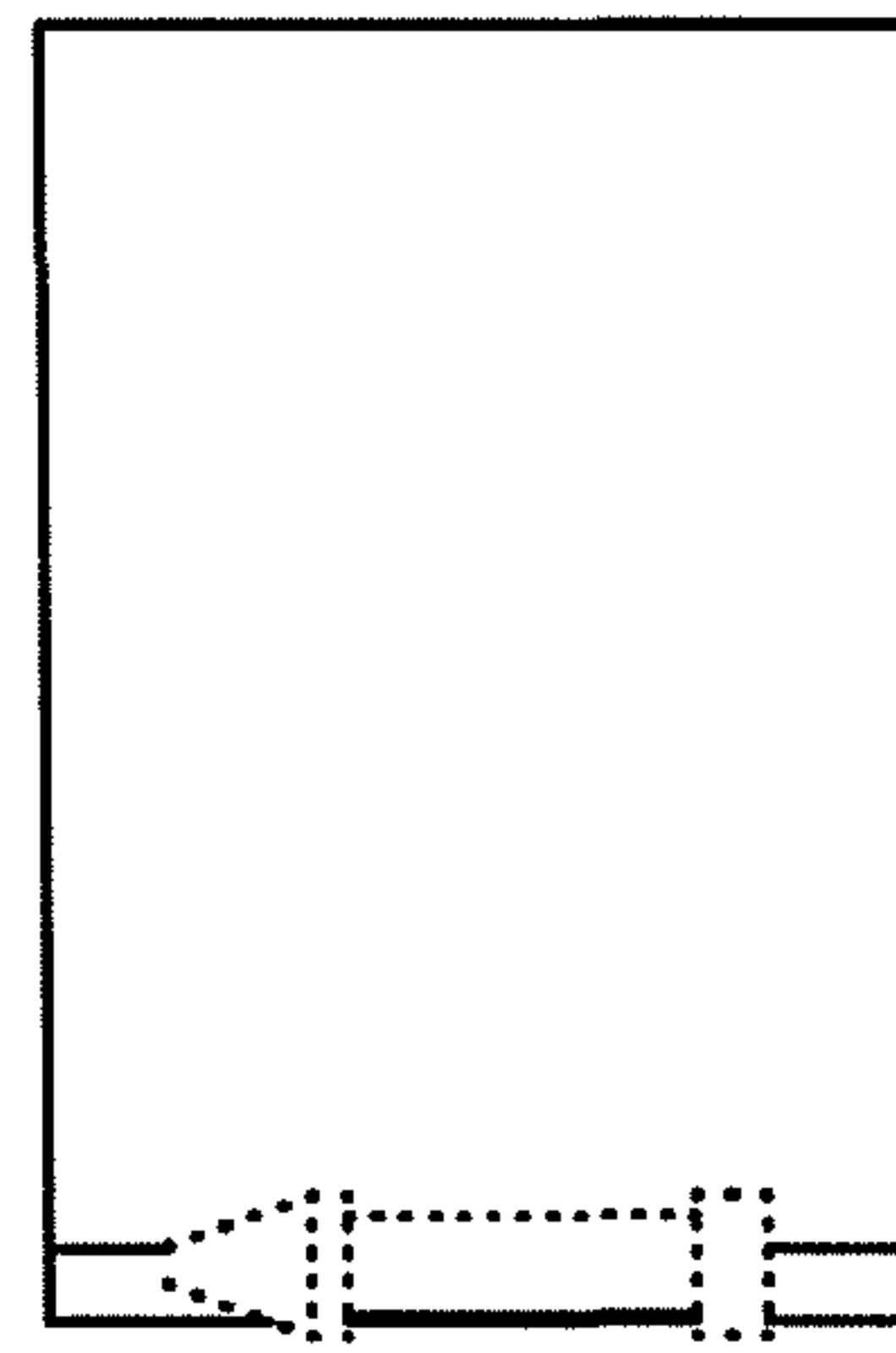

Fig. 14

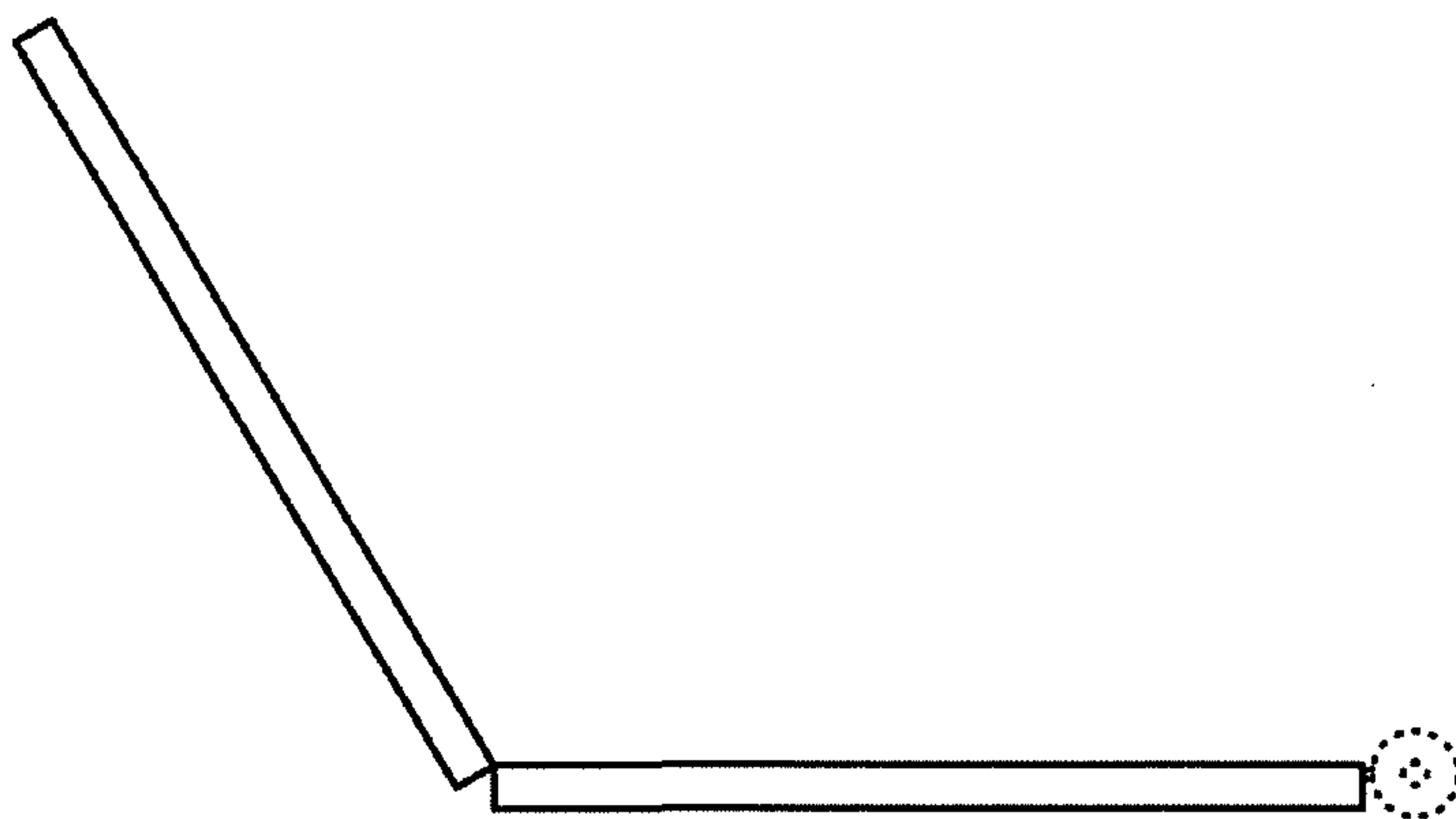

Fig. 15

