

US00D689665S

(12) **United States Design Patent**
Pollmann et al.

(10) **Patent No.:** **US D689,665 S**

(45) **Date of Patent:** **** Sep. 10, 2013**

(54) **AUTOMATED TELLER MACHINE**

(75) Inventors: **Gregor Pollmann**, Paderborn (DE);
Frank Bleck, Paderborn (DE)

(73) Assignee: **Wincor Nixdorf International GmbH**
(DE)

(**) Term: **14 Years**

(21) Appl. No.: **29/412,131**

(22) Filed: **Jan. 31, 2012**

(51) **LOC (9) Cl.** **20-01**

(52) **U.S. Cl.**
USPC **D99/28**

(58) **Field of Classification Search**
USPC ... D99/28, 34, 35, 36, 43, 99; D14/300–303,
D14/900–902;
D18/3.1–3.3, 4.1–4.6, 12.1–12.3; 206/0.8,
206/0.81, 0.815, 0.82, 0.83, 0.84; 101/66;
109/1 R, 1 V, 2, 23, 24.1, 25, 58, 58.5, 66;
446/8–13; 705/16, 17, 18, 42, 43, 44, 45

See application file for complete search history.

(56) **References Cited**

U.S. PATENT DOCUMENTS

D282,937	S	*	3/1986	Di Benedetto et al.	D20/1
D308,275	S	*	5/1990	Garten et al.	D99/28
D318,553	S	*	7/1991	Brown	D99/28
5,202,549	A	*	4/1993	Decker et al.	235/379
D377,170	S	*	1/1997	Wilson	D14/130
D388,229	S	*	12/1997	Couch	D99/28
D395,129	S	*	6/1998	Johnson	D99/28
D395,458	S	*	6/1998	Smith et al.	D21/329
D427,742	S	*	7/2000	McCormack et al.	D99/28
D429,401	S	*	8/2000	Sato et al.	D99/28
D436,630	S	*	1/2001	Gonsiorowski et al.	D20/10
D449,726	S	*	10/2001	Lin	D99/28
D451,968	S	*	12/2001	Sano	D21/325
D471,192	S	*	3/2003	Lin et al.	D14/335
D483,760	S	*	12/2003	Berr et al.	D14/383

D483,761	S	*	12/2003	Berr et al.	D14/383
7,191,948	B1	*	3/2007	Baitz et al.	235/462.43
D581,934	S		12/2008	Kruse et al.		
D584,875	S		1/2009	Bleck		
D589,048	S		3/2009	Nossek		
D590,575	S		4/2009	Bleck		

(Continued)

Primary Examiner — Elizabeth J Oswecki

(74) *Attorney, Agent, or Firm* — Harness, Dickey & Pierce,
P.L.C.

(57) **CLAIM**

The ornamental design for an automated teller machine, as shown and described.

DESCRIPTION

FIG. 1 is a front view of a first embodiment of an automated teller machine showing our new design;
 FIG. 2 is a rear view thereof;
 FIG. 3 is a left side view thereof;
 FIG. 4 is a right side view thereof;
 FIG. 5 is a top view thereof;
 FIG. 6 is a bottom view thereof;
 FIG. 7 is a top, left side perspective view thereof;
 FIG. 8 is another top, left side perspective view thereof, adjacent environmental structure shown in broken lines;
 FIG. 9 is a front view of a second embodiment of an automated teller machine showing our new design;
 FIG. 10 is a rear view thereof;
 FIG. 11 is a left side view thereof;
 FIG. 12 is a right side view thereof;
 FIG. 13 is a top view thereof;
 FIG. 14 is a bottom view thereof;
 FIG. 15 is a top, left side perspective view thereof; and,
 FIG. 16 is another top, left side perspective view thereof, adjacent environmental structure shown in broken lines.
 The broken lines are for illustrative purposes only and do not form part of the claimed design.

1 Claim, 16 Drawing Sheets

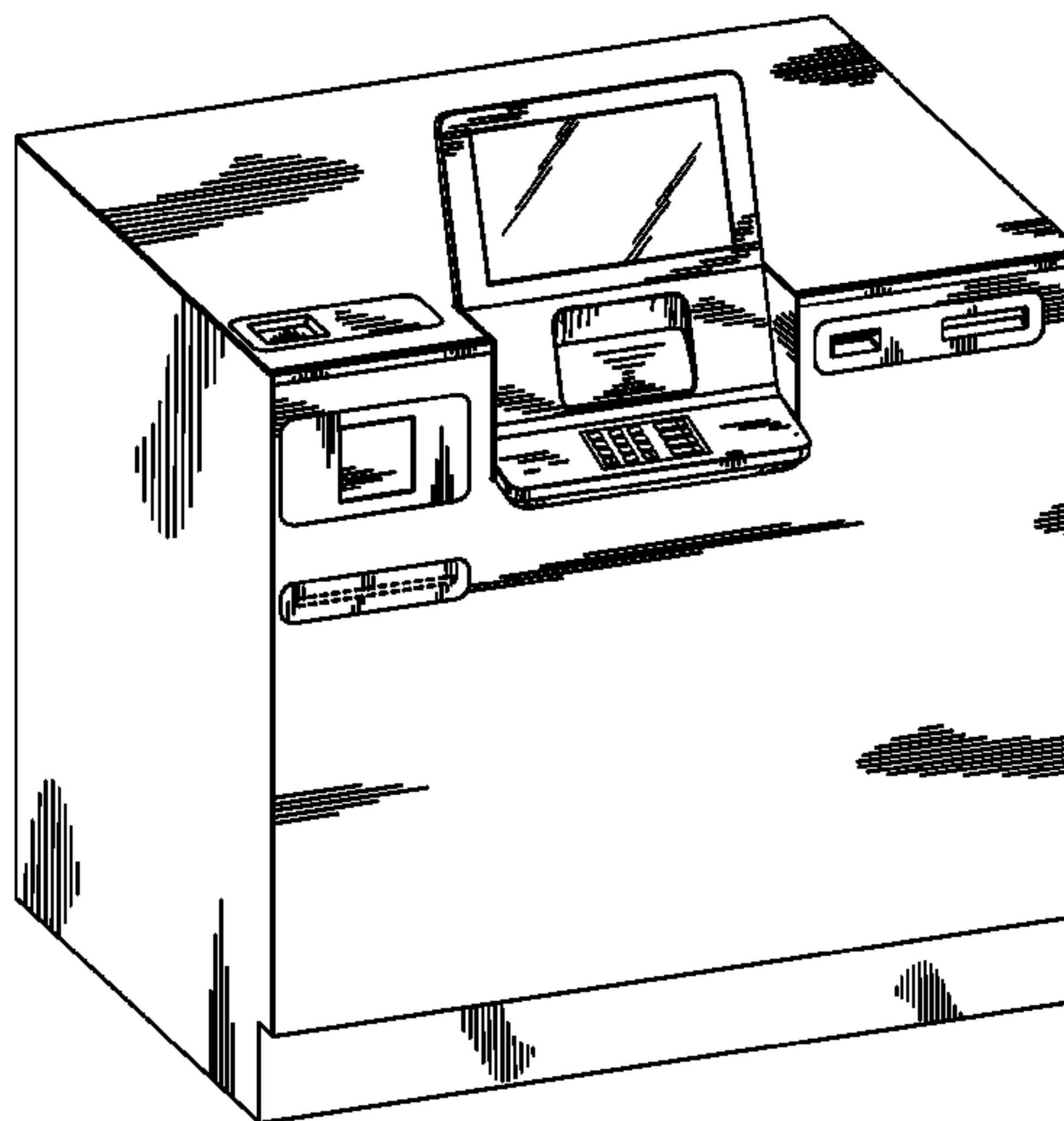
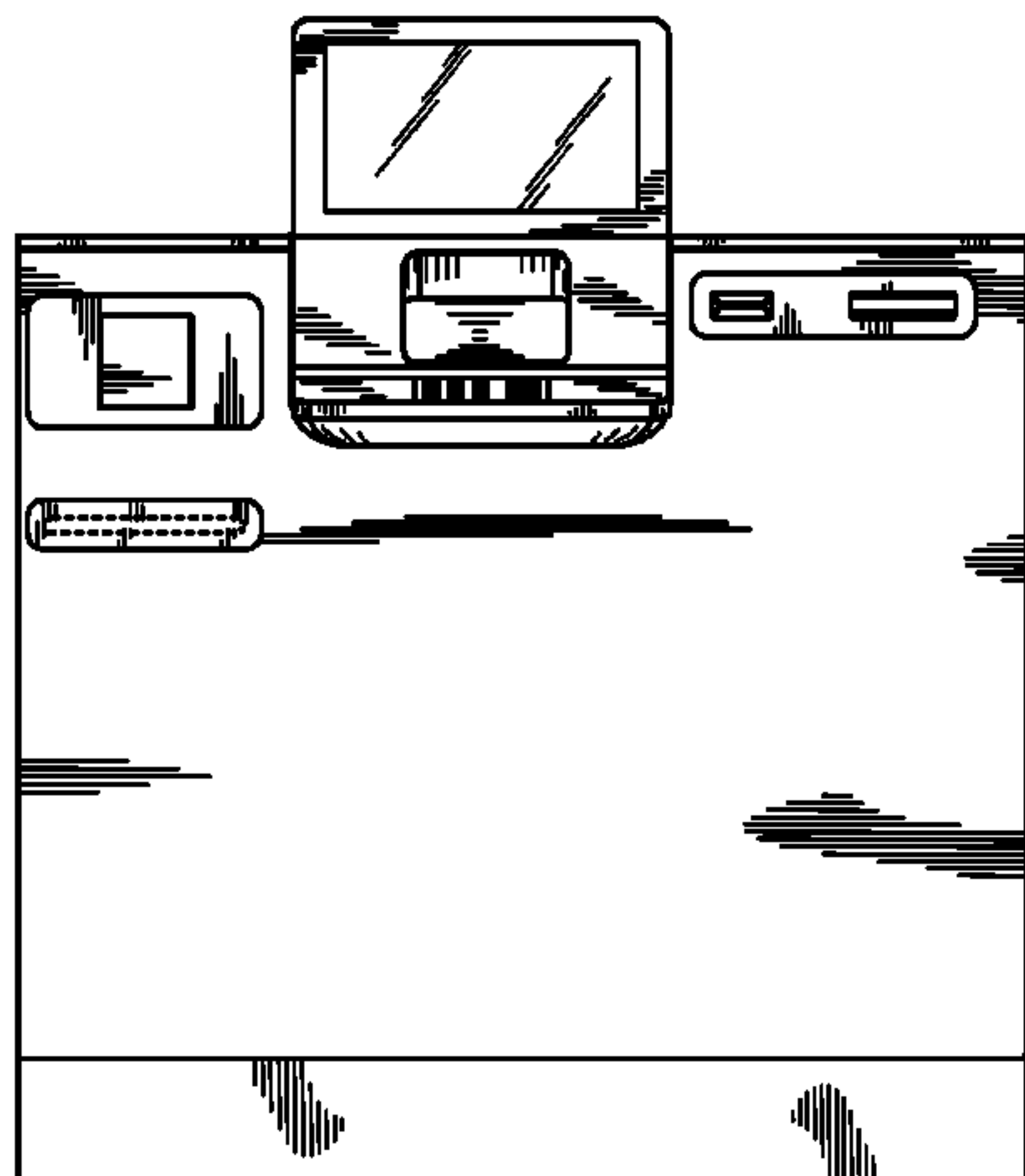

(56)

References Cited

U.S. PATENT DOCUMENTS

D603,125 S * 10/2009 Lara Bartolome D99/28
D605,190 S * 12/2009 Kuroda et al. D14/307
D625,305 S 10/2010 Bleck et al.
D626,544 S 11/2010 Bleck et al.
D626,545 S 11/2010 Bleck et al.
D628,764 S 12/2010 Bleck et al.

D629,585 S 12/2010 Bleck et al.
D631,264 S 1/2011 Kruse
D631,634 S 1/2011 Bleck et al.
D631,676 S 2/2011 Kruse
D645,223 S 9/2011 Bleck et al.
D648,953 S 11/2011 Kruse
D652,650 S 1/2012 Kruse
D678,652 S * 3/2013 Budde et al. D99/28

* cited by examiner

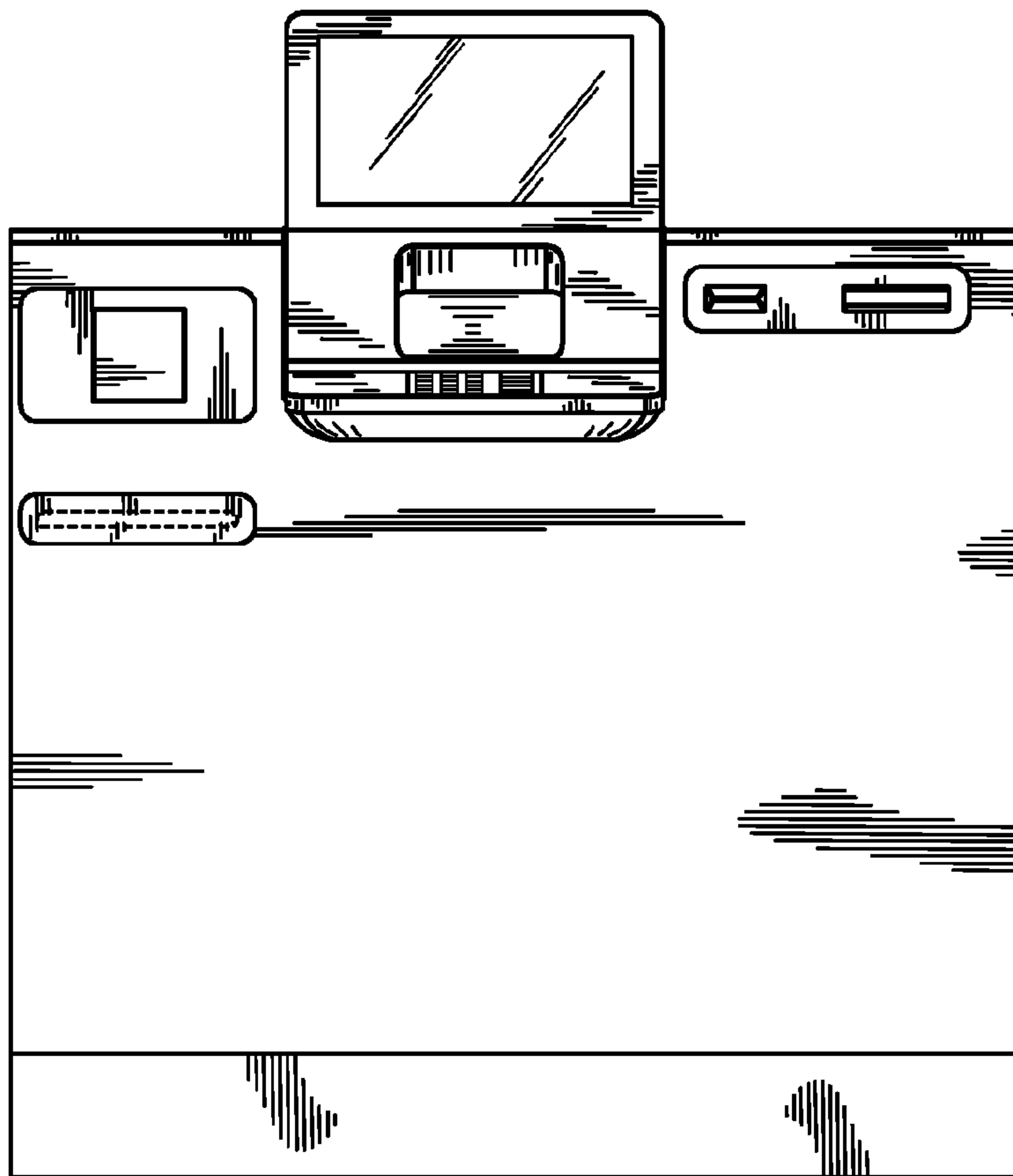

FIG. 1

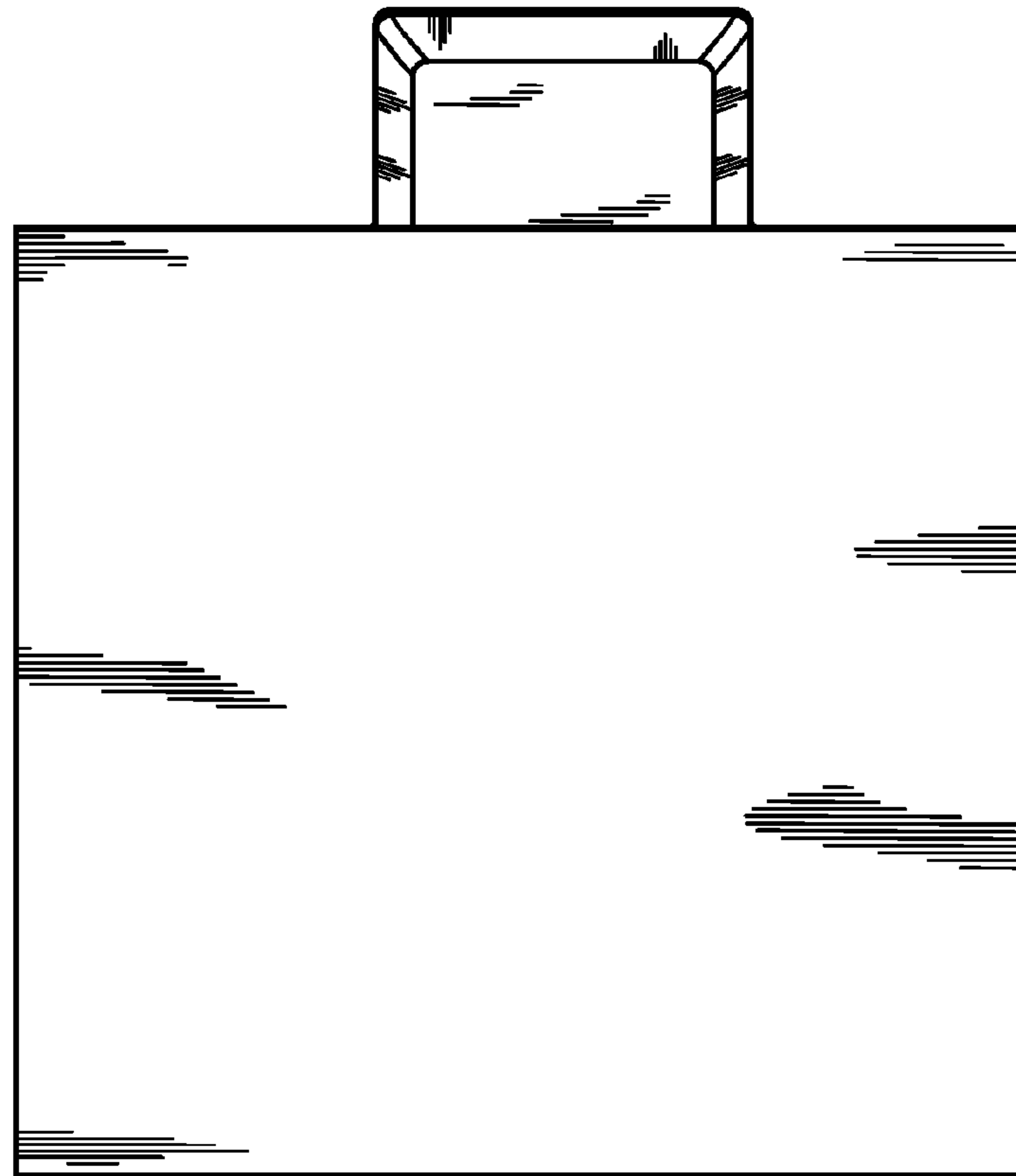

FIG. 2

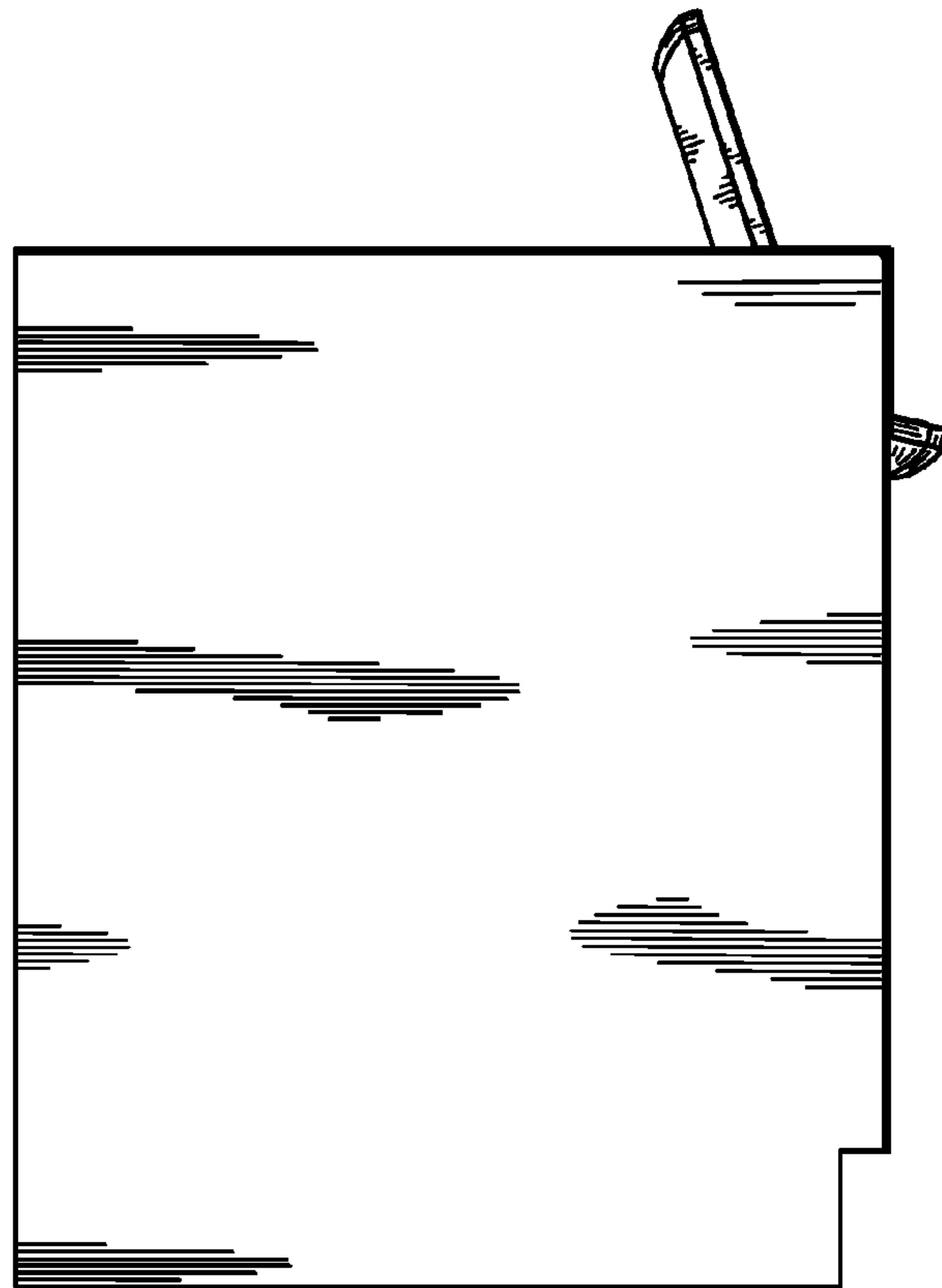

FIG. 3

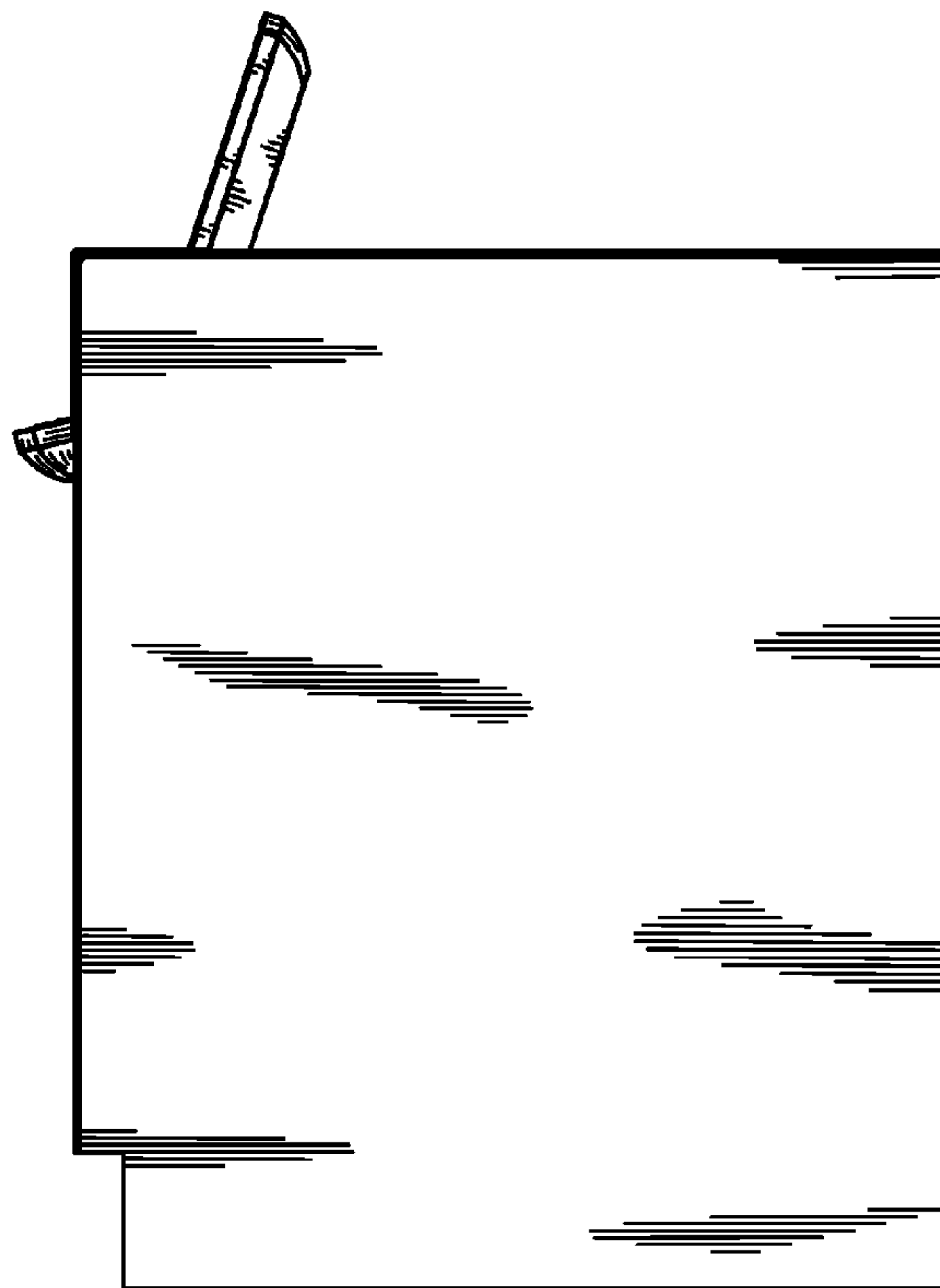

FIG. 4

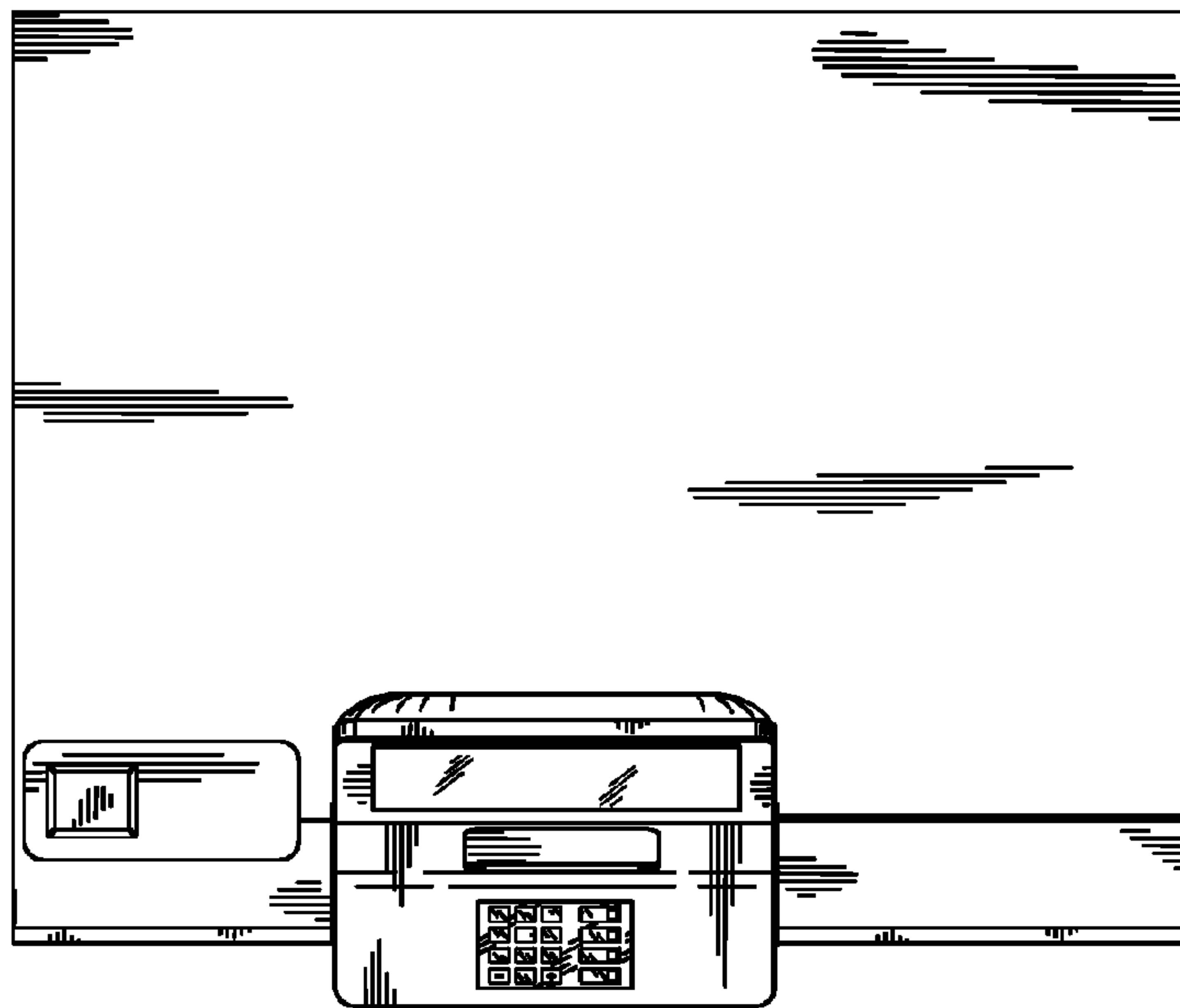

FIG. 5

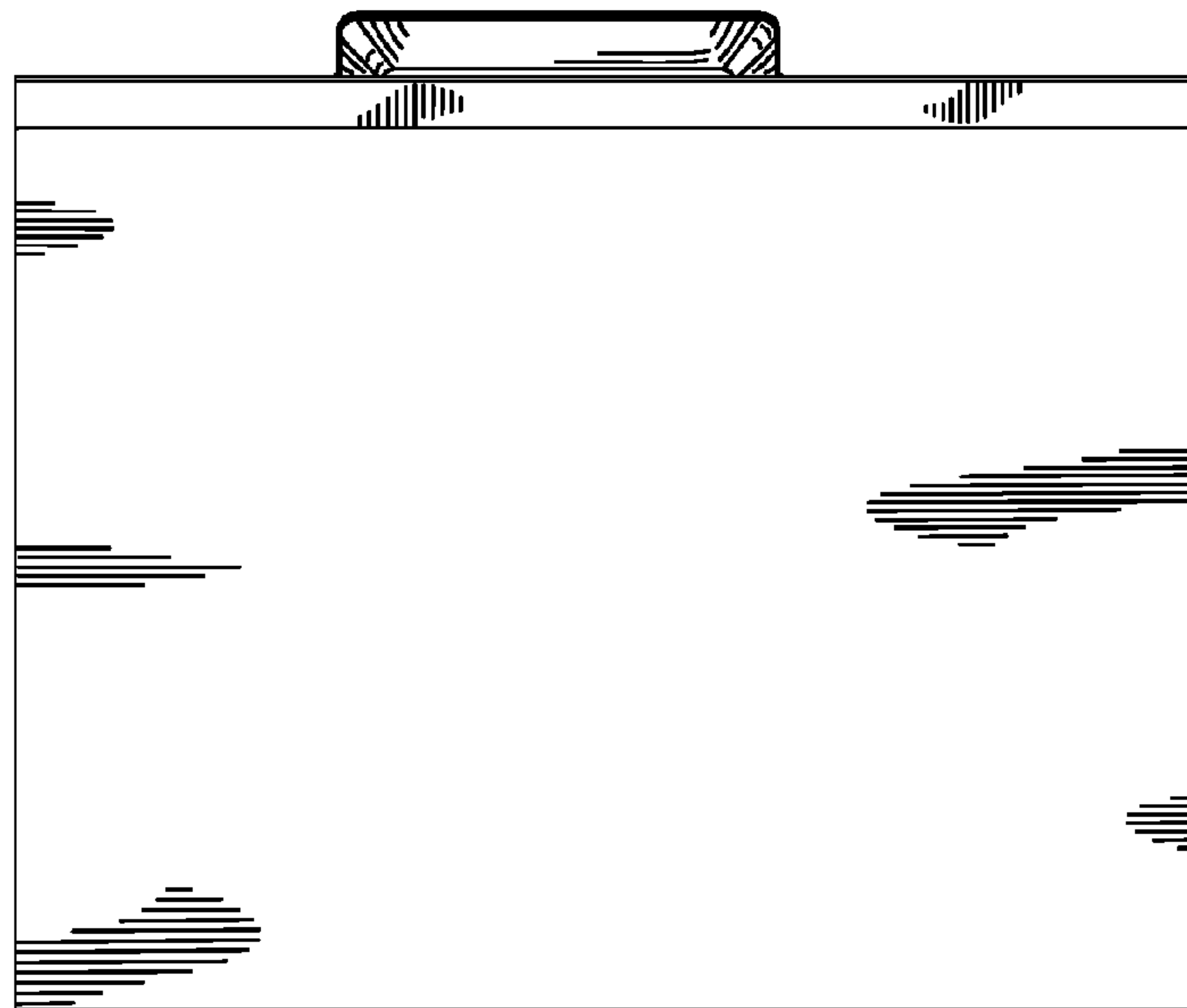

FIG. 6

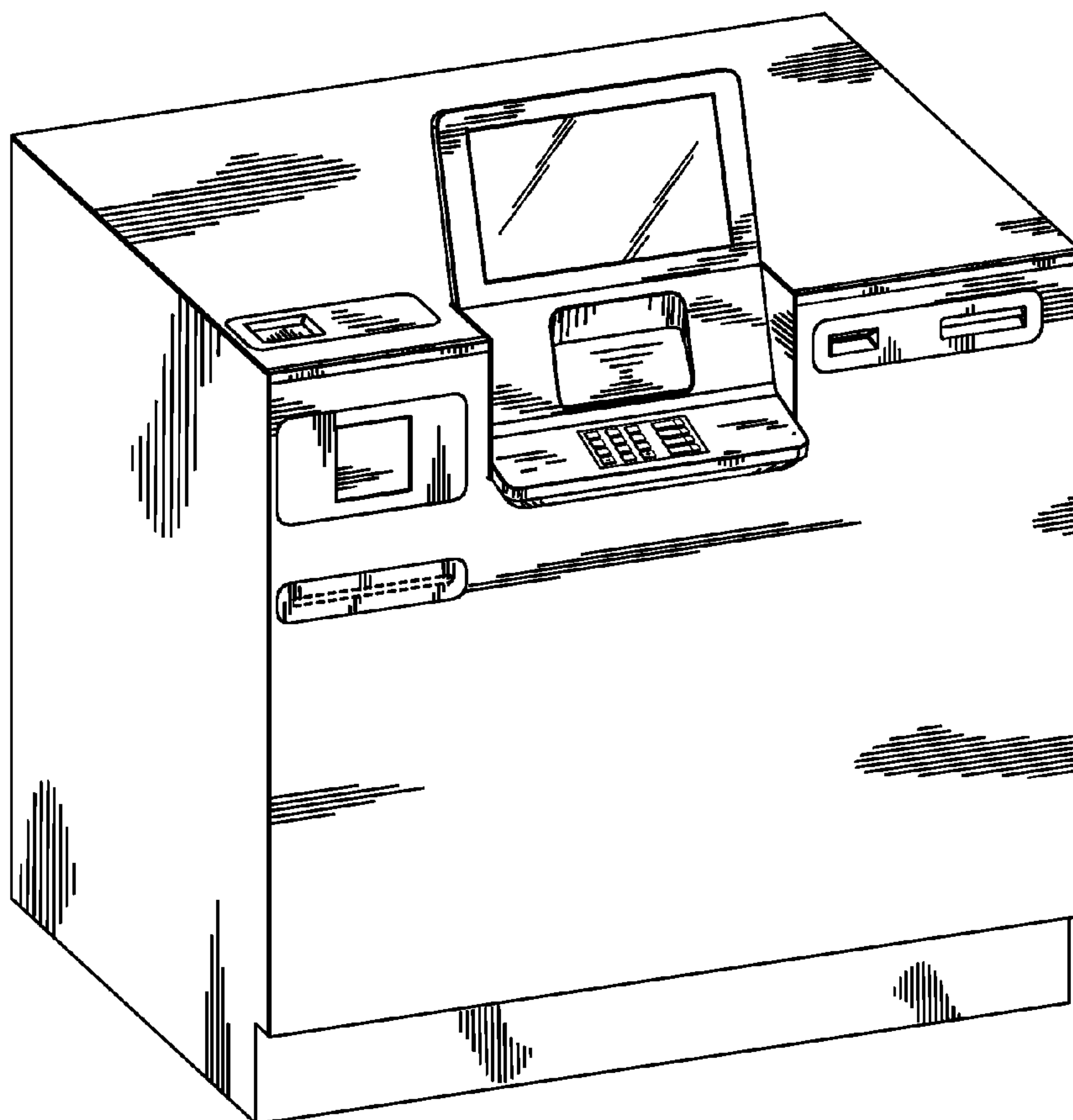

FIG. 7

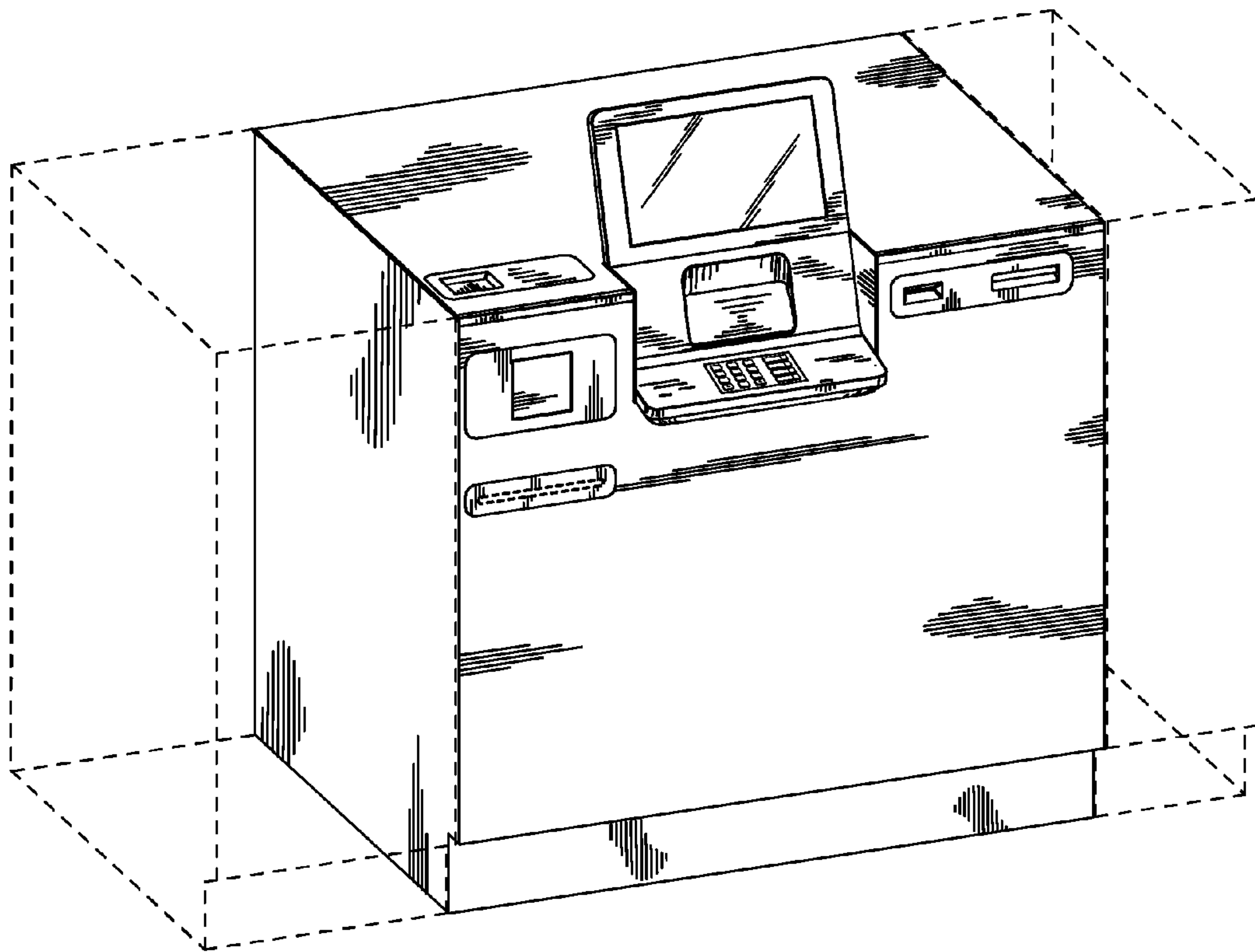

FIG. 8

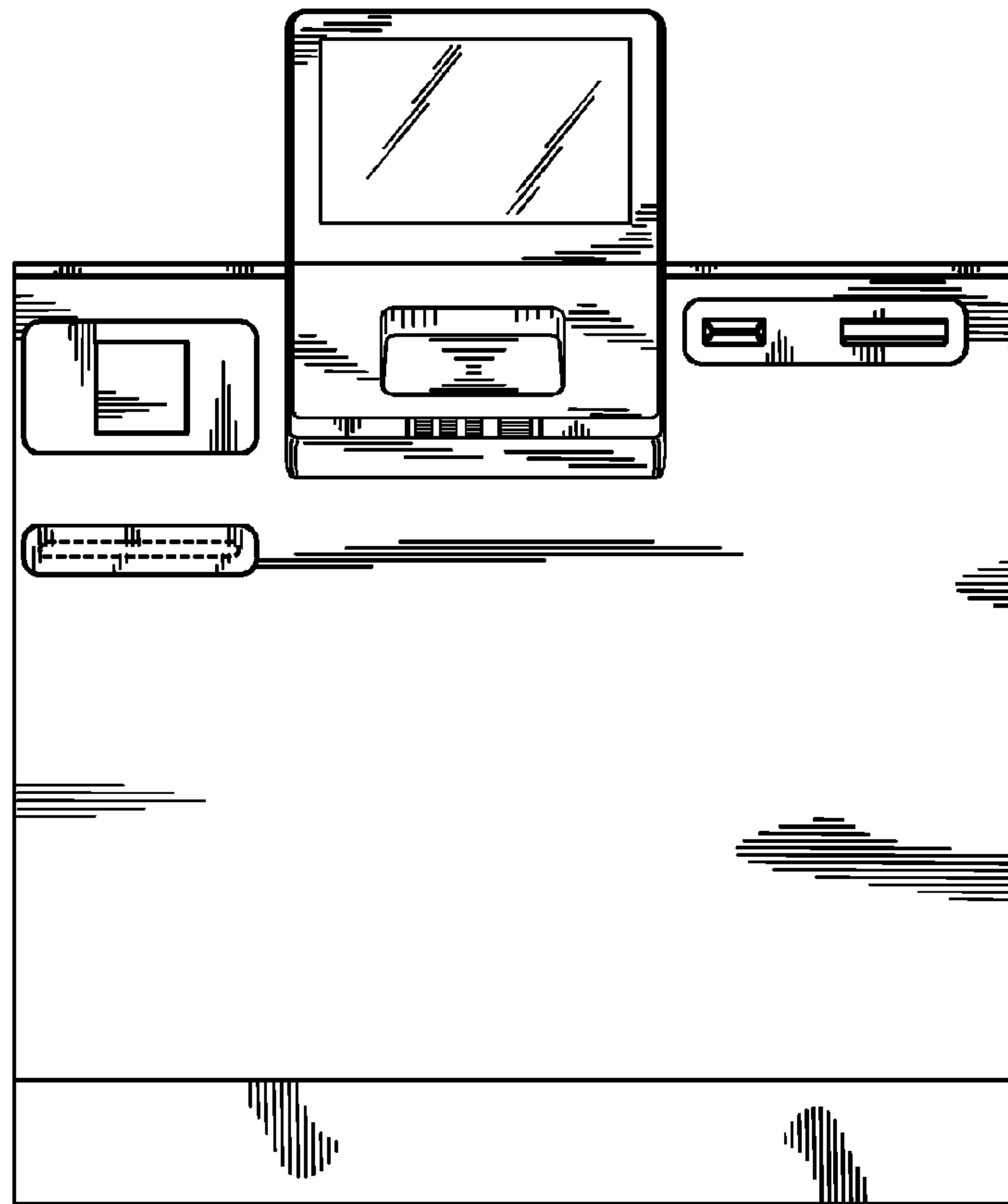

FIG. 9



FIG. 10

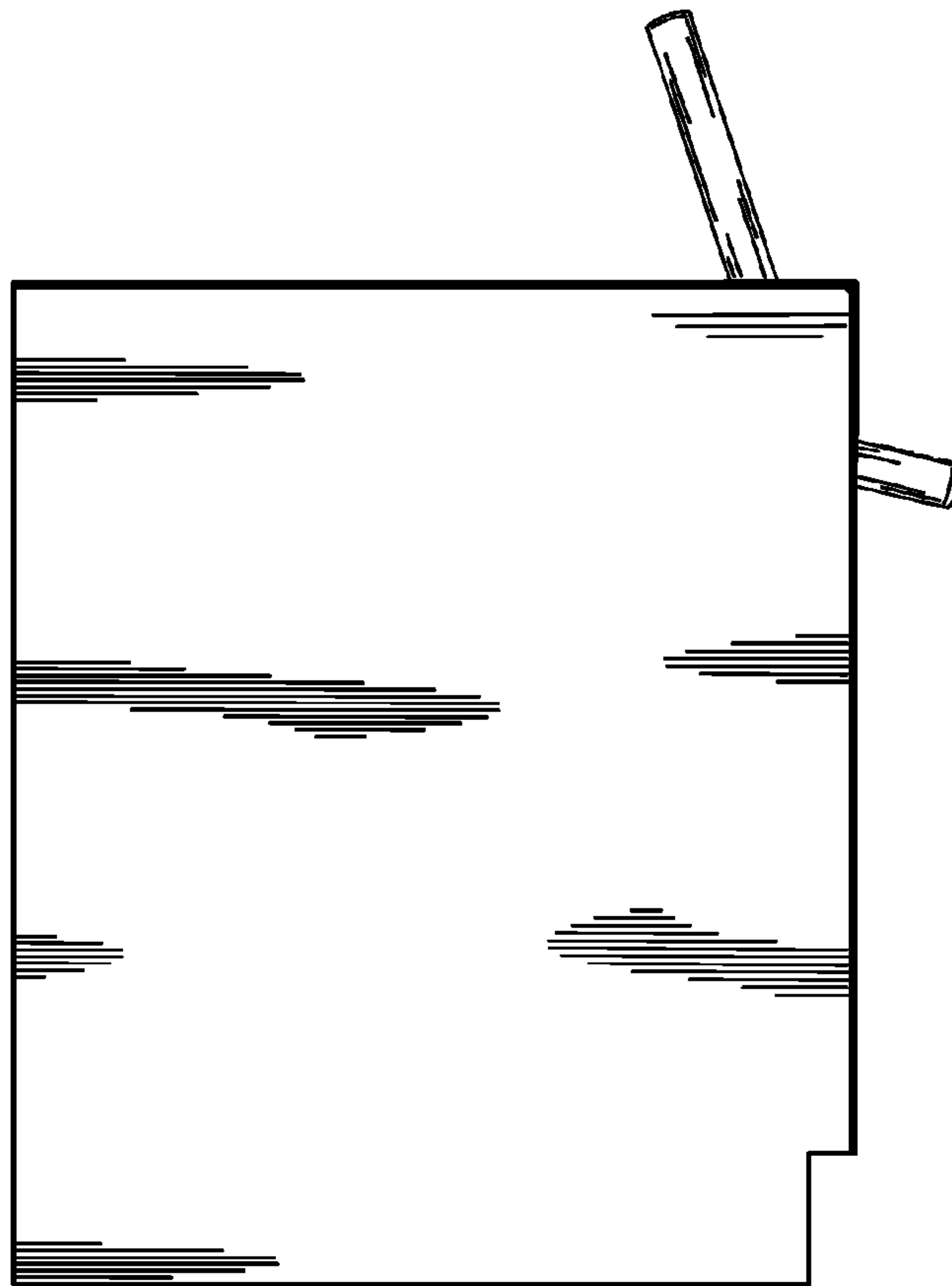

FIG. 11

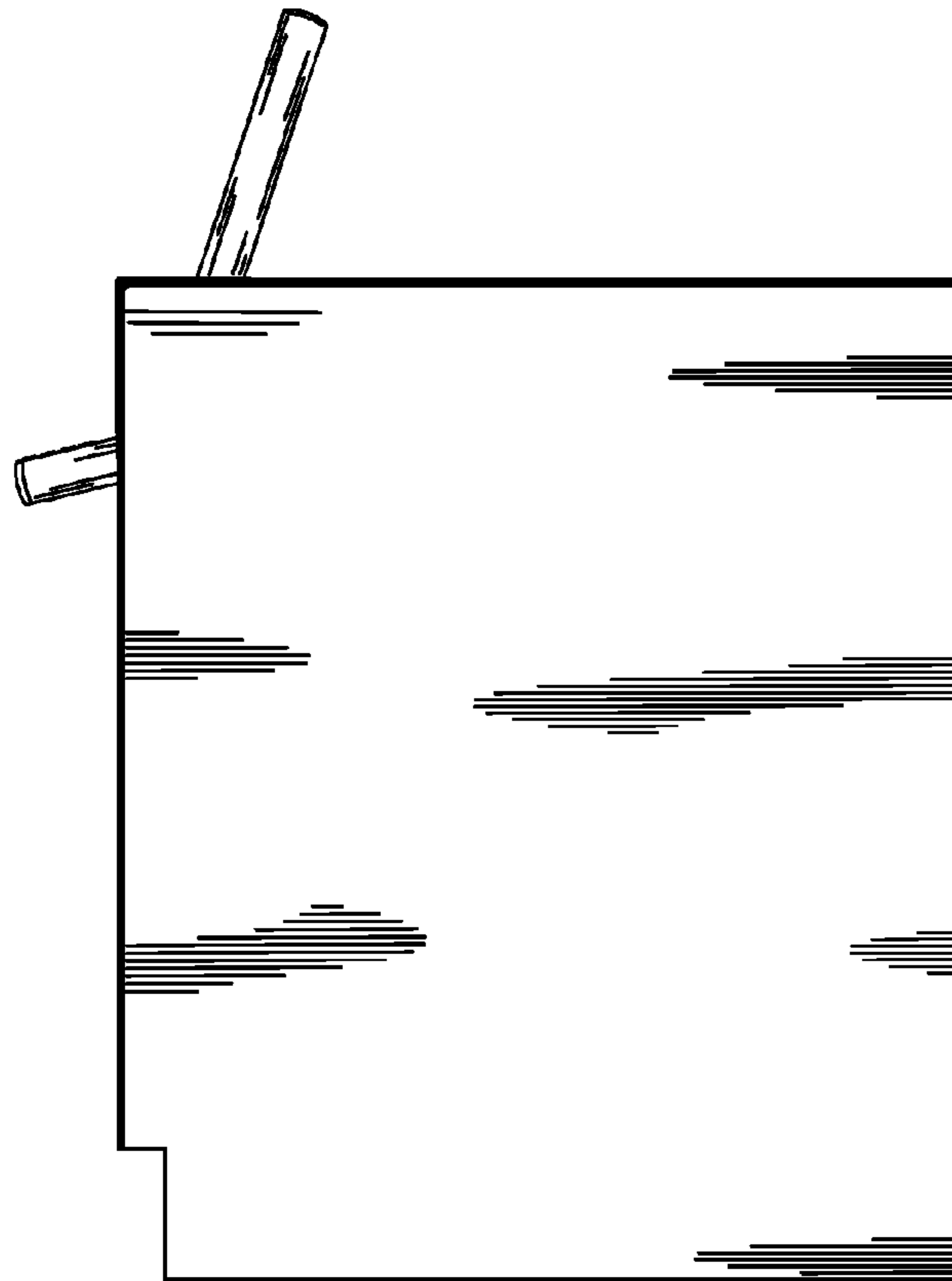

FIG. 12

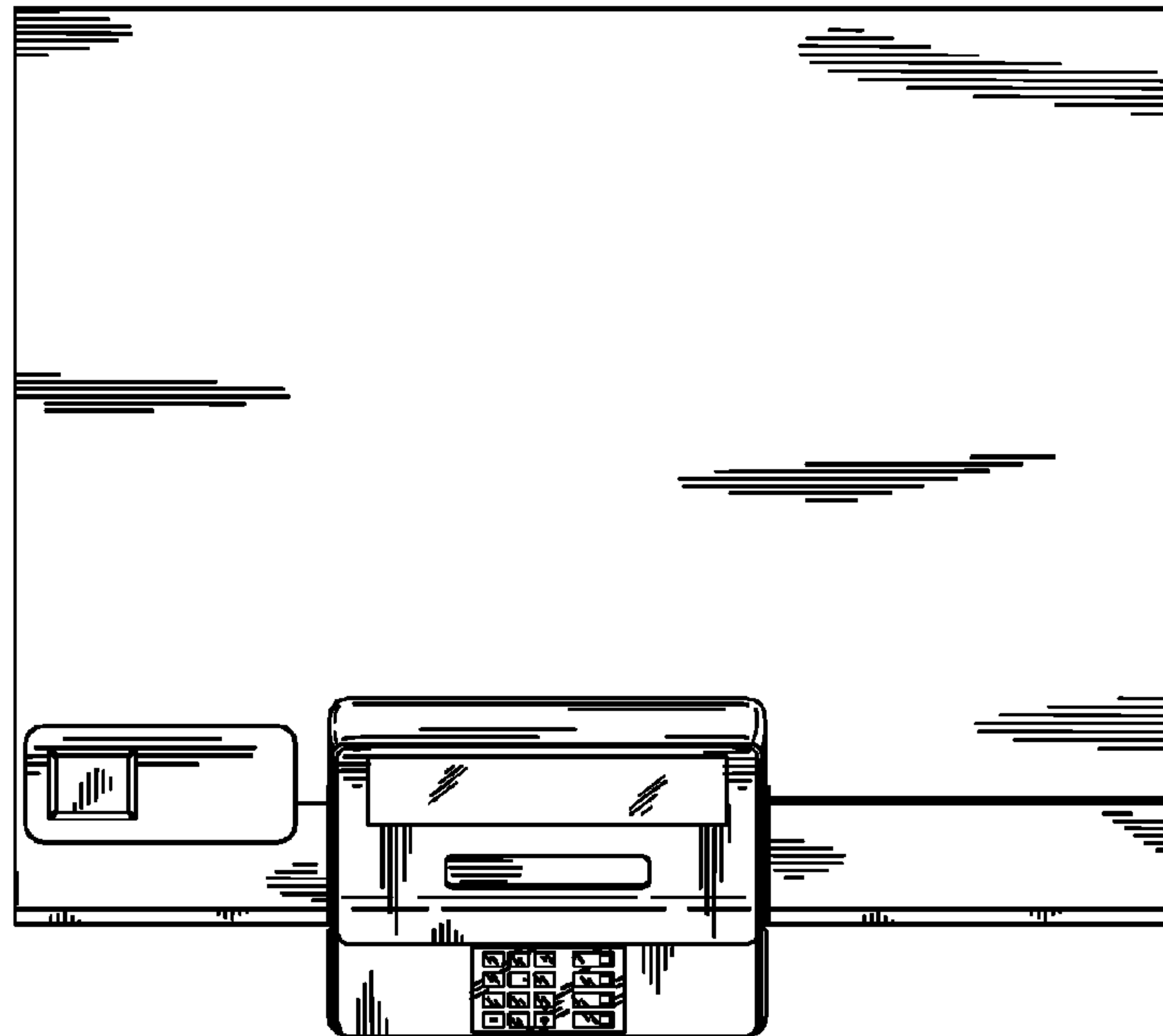

FIG. 13

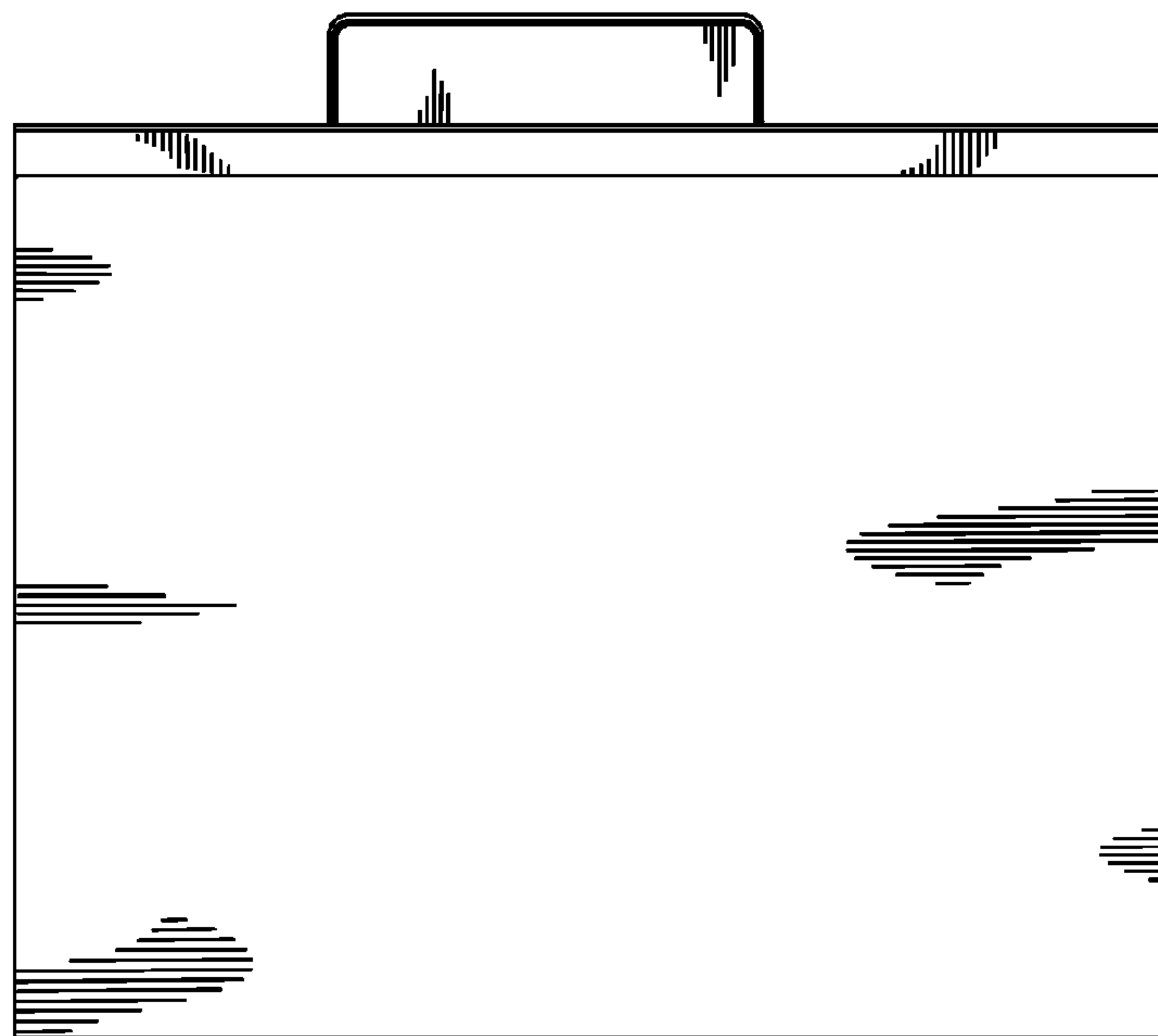

FIG. 14

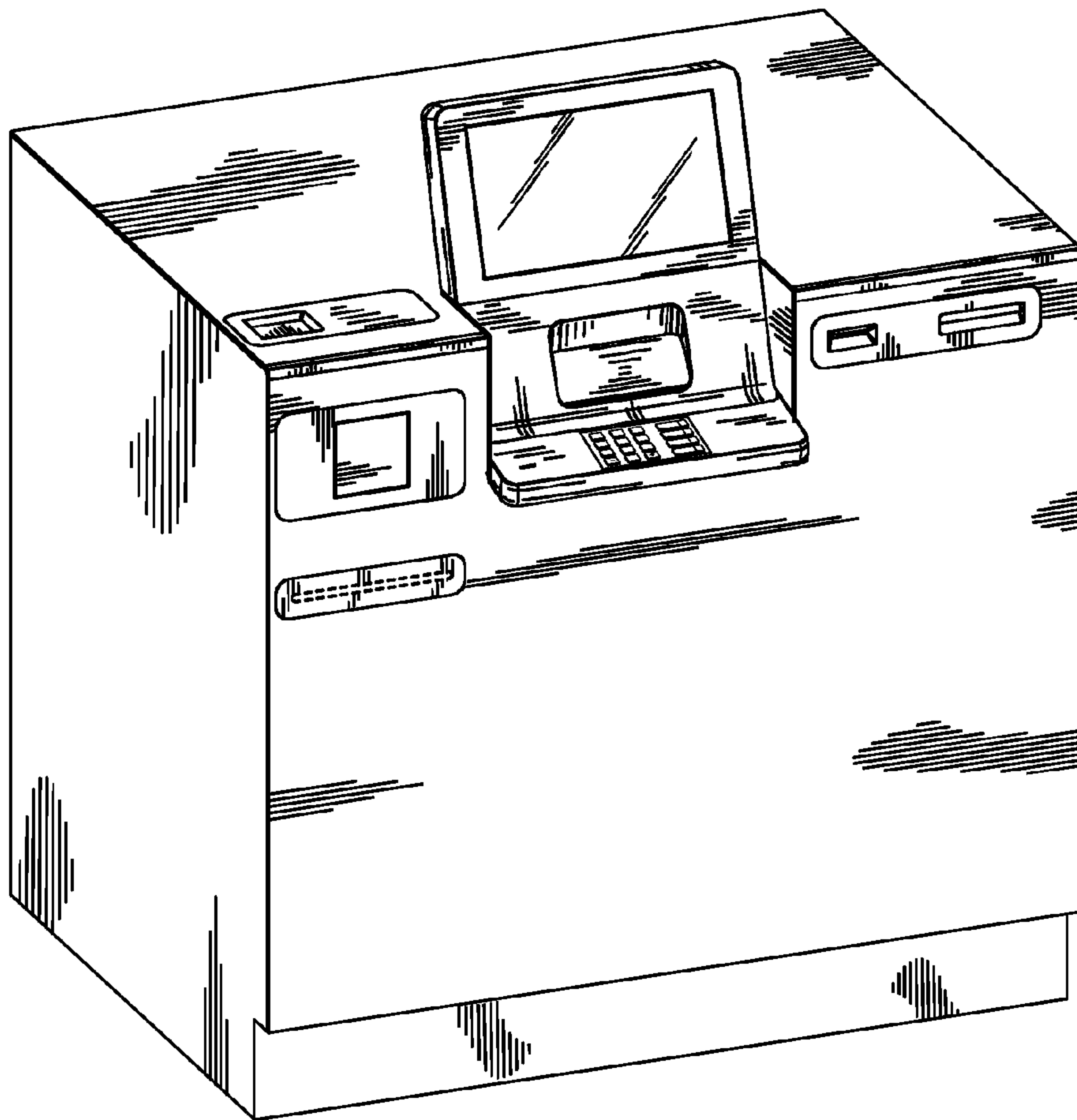

FIG. 15

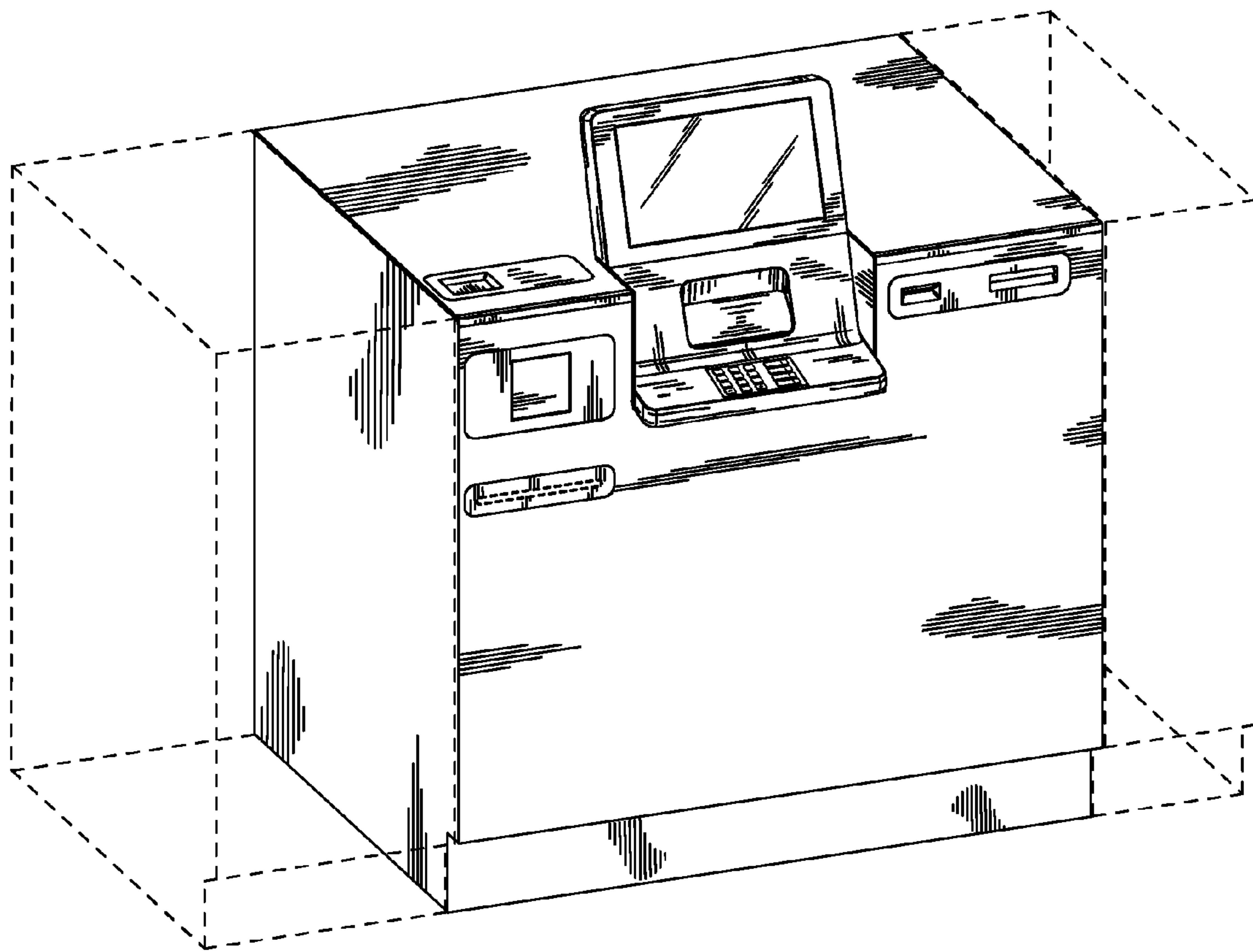

FIG. 16