

US00D689632S

(12) **United States Design Patent**  
**Rochat et al.**

(10) **Patent No.:** **US D689,632 S**

(45) **Date of Patent:** **\*\* Sep. 10, 2013**

(54) **LED BULB HEATSINK**

(75) Inventors: **Alex Rochat**, Emeryville, CA (US); **Jeff Salazar**, Palo Alto, CA (US); **David Titzler**, Palo Alto, CA (US); **Andrew Webb**, San Jose, CA (US)

(73) Assignee: **Switch Bulb Company, Inc.**, San Jose, CA (US)

(\*\*) Term: **14 Years**

(21) Appl. No.: **29/410,660**

(22) Filed: **Jan. 10, 2012**

(51) **LOC (9) Cl.** ..... **26-04**

(52) **U.S. Cl.**  
USPC ..... **D26/2**

(58) **Field of Classification Search**  
USPC ..... D26/1-4; 313/313, 315, 316, 317,  
313/318, 493; 315/52, 53, 56, 57, 58  
See application file for complete search history.

(56) **References Cited**

**U.S. PATENT DOCUMENTS**

D617,475 S *	6/2010	Hiraga et al.	.....	D26/2
D632,406 S *	2/2011	Wei	.....	D26/2
D648,461 S *	11/2011	Kim et al.	.....	D26/2
D653,366 S *	1/2012	Le et al.	.....	D26/2

**OTHER PUBLICATIONS**

Office Action received for Japanese Patent Application No. 2012-016404, mailed on Nov. 13, 2012, 2 page (1 page of English Translation and 1 page of Office Action).

\* cited by examiner

*Primary Examiner* — Marcus Jackson

(74) *Attorney, Agent, or Firm* — Morrison & Foerster LLP

(57) **CLAIM**

The ornamental design for an LED bulb heatsink, as shown and described.

**DESCRIPTION**

FIG. 1 is a perspective view of a first embodiment of an LED bulb heatsink;

FIG. 2 is a side view of the first embodiment;

FIG. 3 is a top view of the first embodiment;

FIG. 4 is a bottom view of the first embodiment;

FIG. 5 is a perspective view of a second embodiment of an LED bulb heatsink;

FIG. 6 is a side view of the second embodiment;

FIG. 7 is a top view of the second embodiment;

FIG. 8 is a bottom view of the second embodiment;

FIG. 9 is a perspective view of a third embodiment of an LED bulb heatsink;

FIG. 10 is a side view of the third embodiment;

FIG. 11 is a top view of the third embodiment;

FIG. 12 is a bottom view of the third embodiment;

FIG. 13 is a perspective view of a fourth embodiment of an LED bulb heatsink;

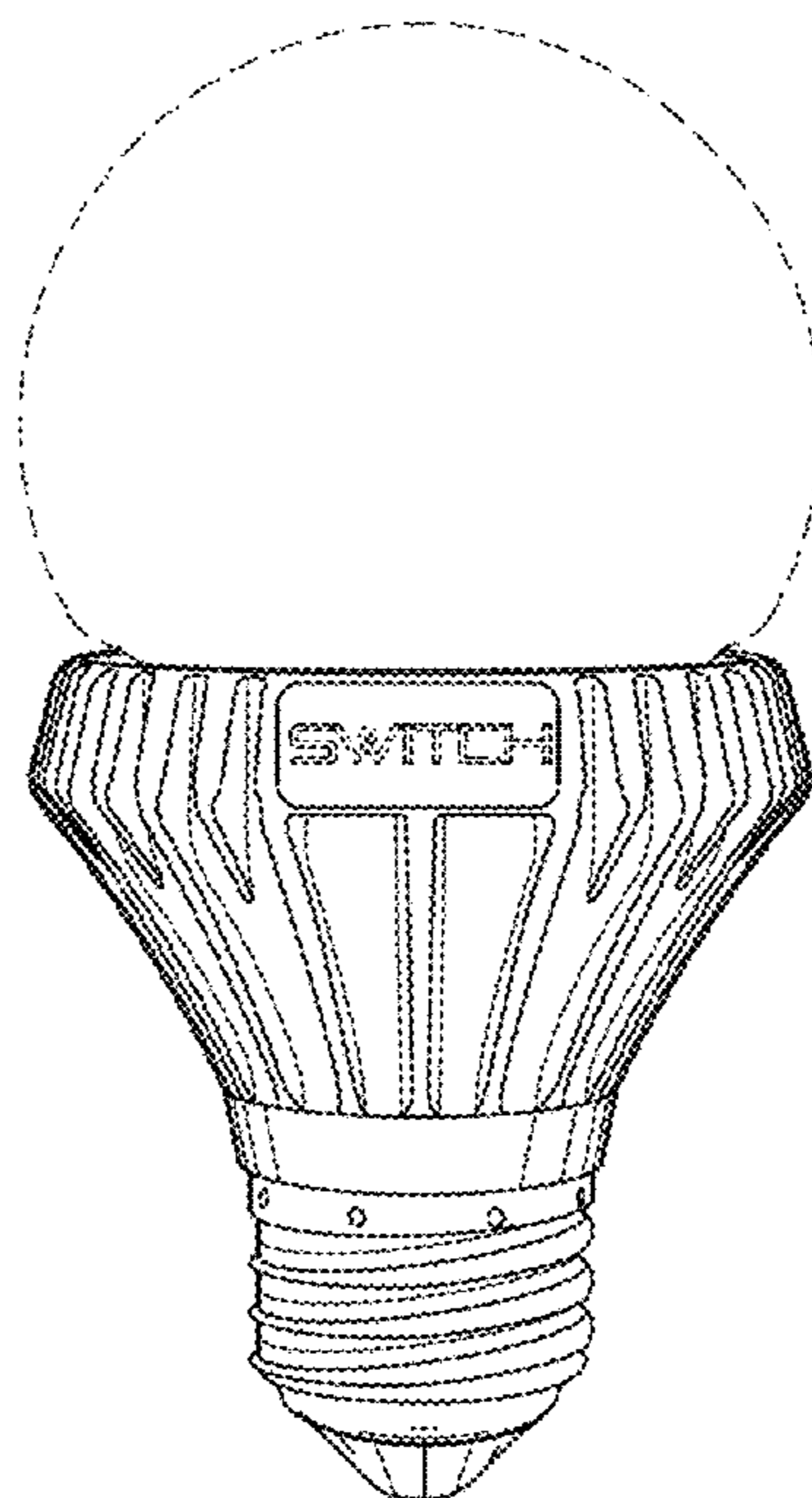
FIG. 14 is a side view of the fourth embodiment;

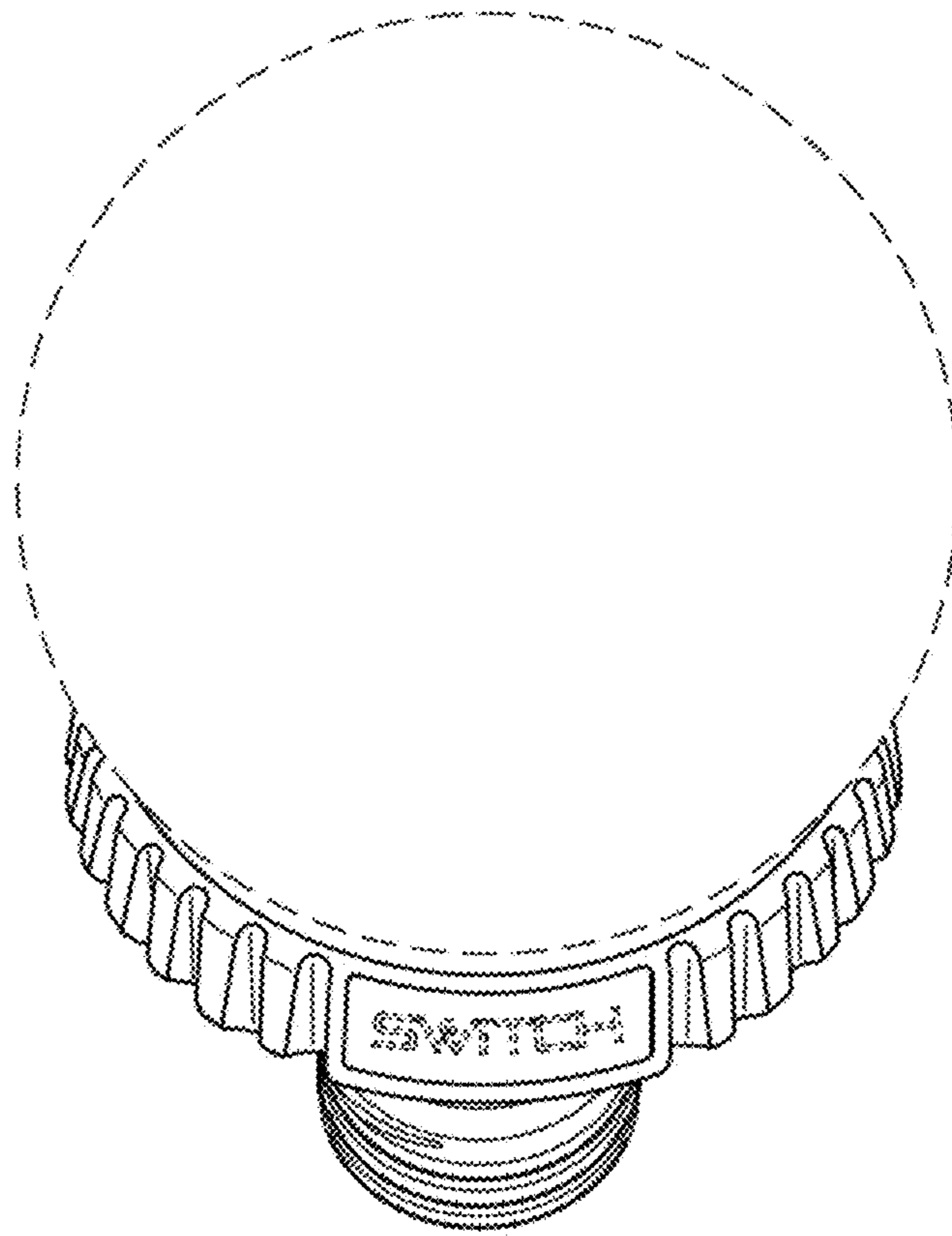
FIG. 15 is a top view of the fourth embodiment; and,

FIG. 16 is a bottom view of the fourth embodiment.

The broken line showing of the bulb portion is included for the purpose of illustrating only and forms no part of the claimed design.

**1 Claim, 12 Drawing Sheets**





**FIG. 1**

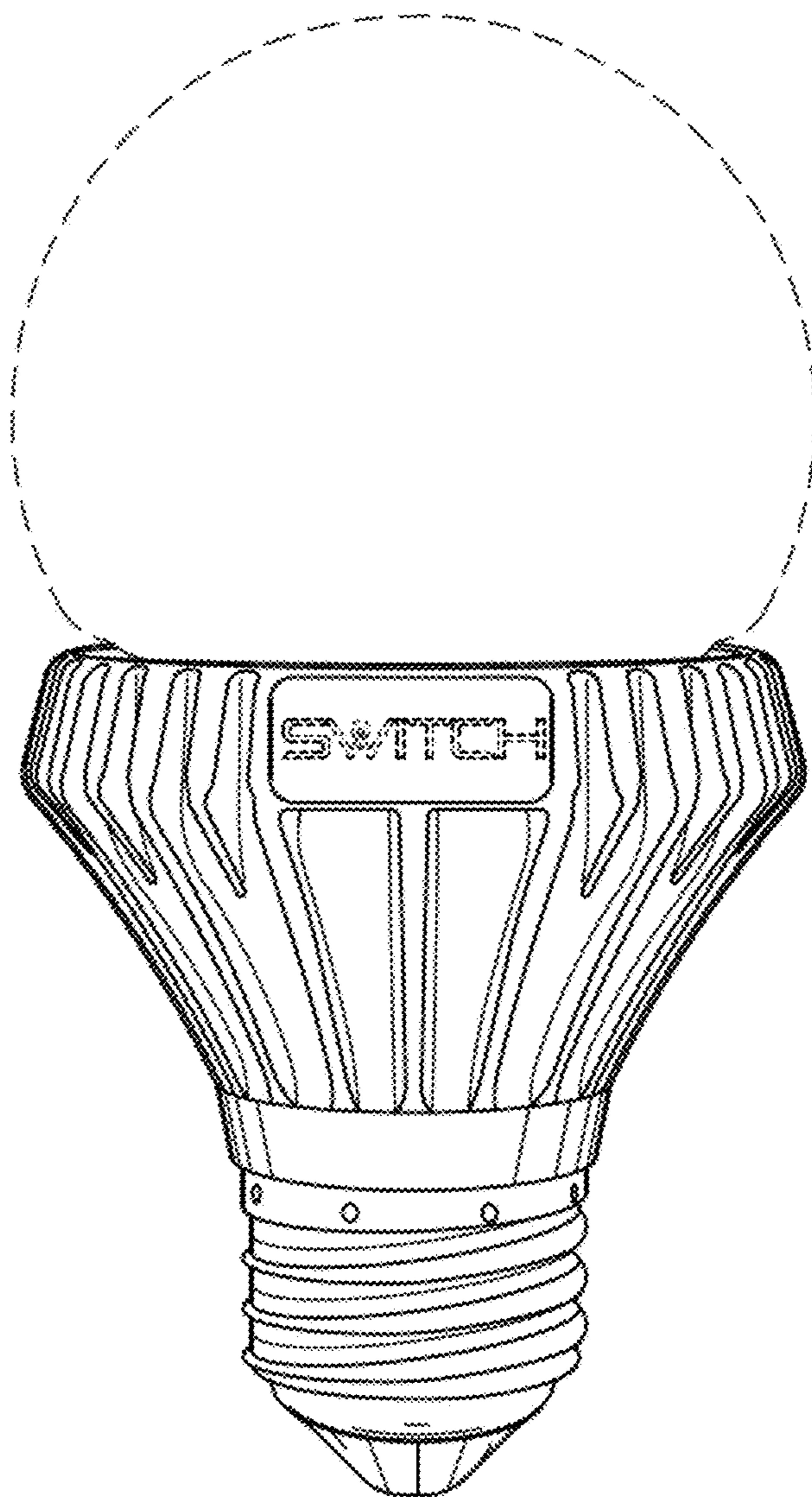
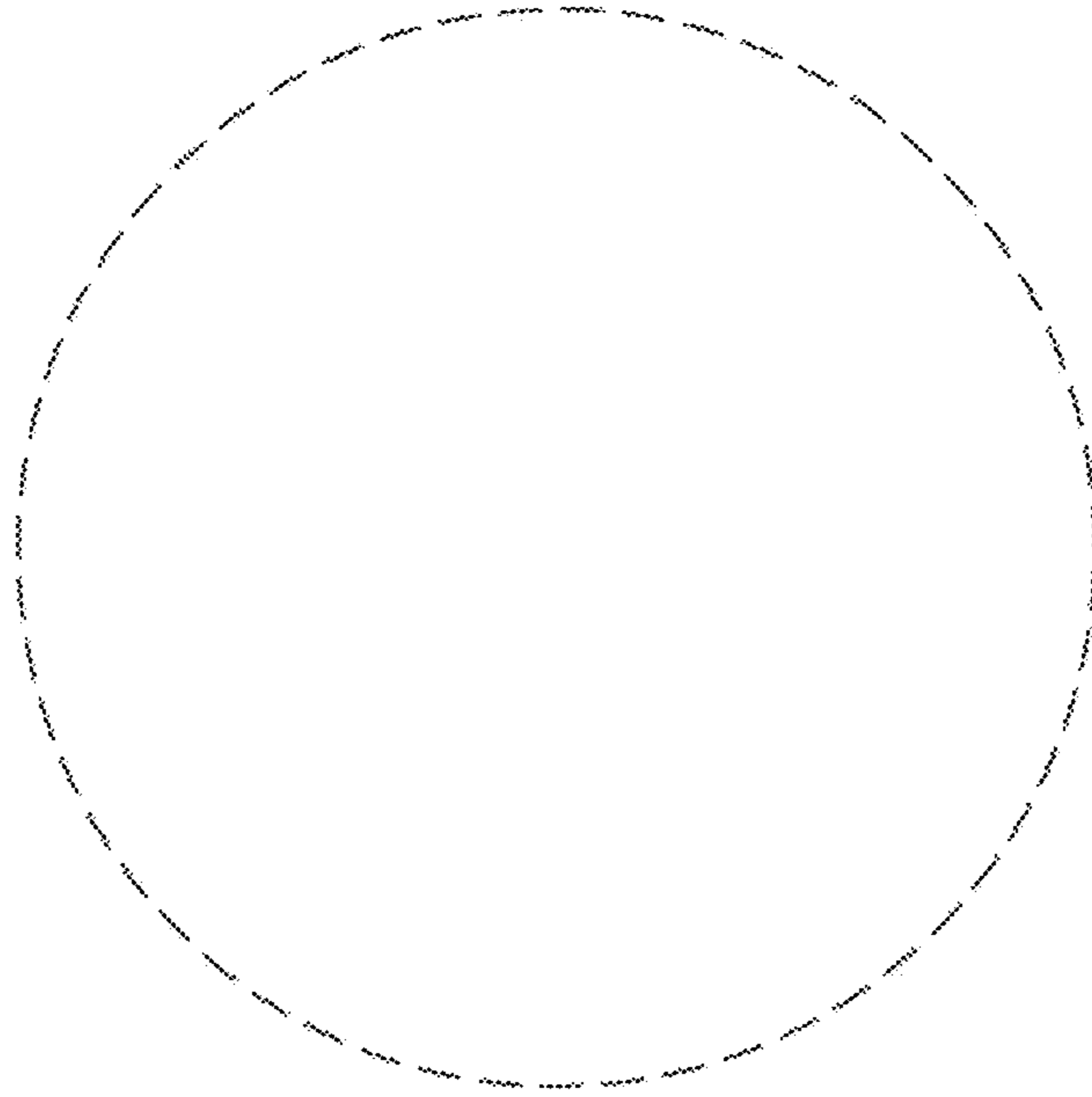
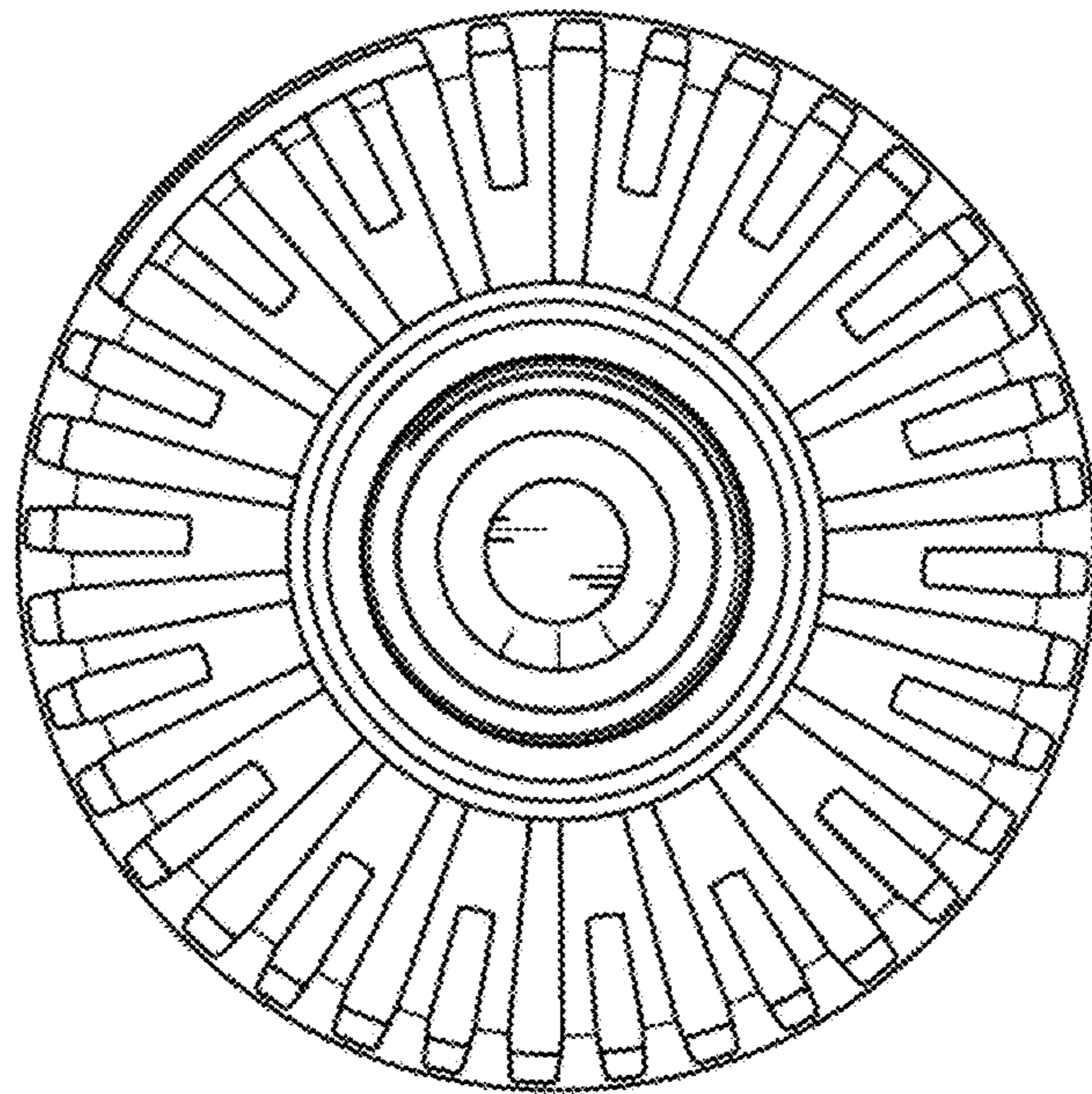


FIG. 2



**FIG. 3**



**FIG. 4**

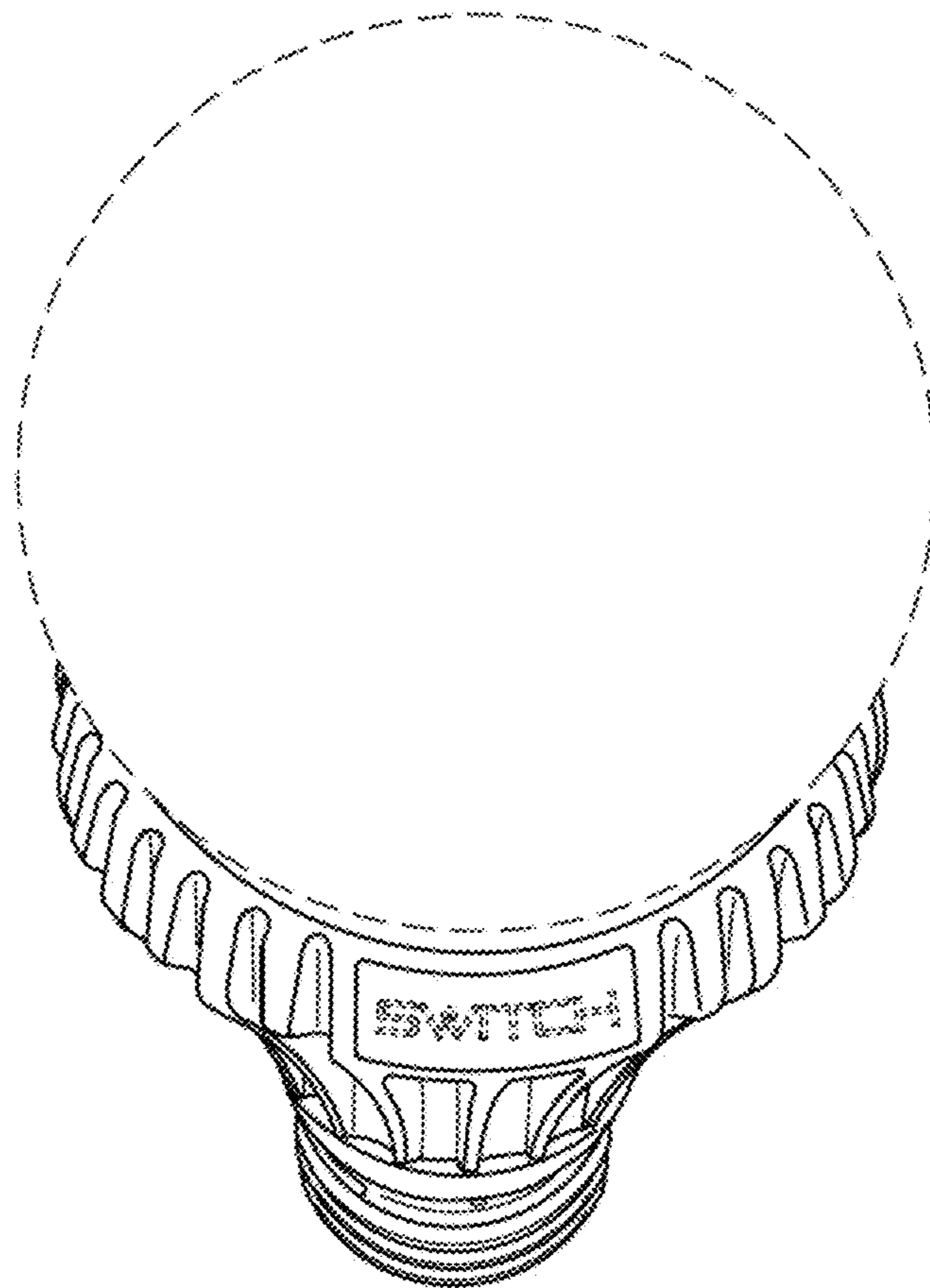


FIG. 5

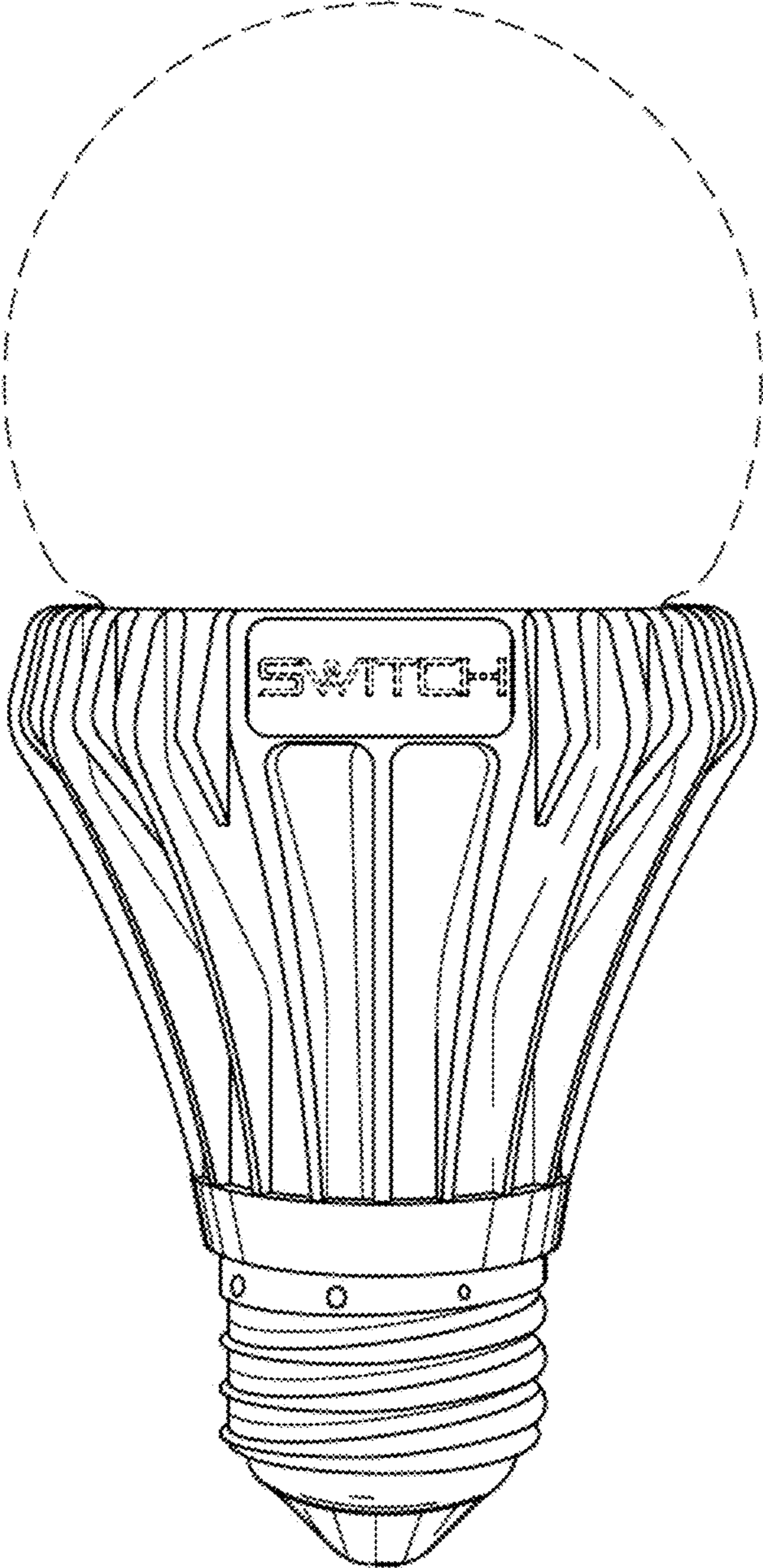
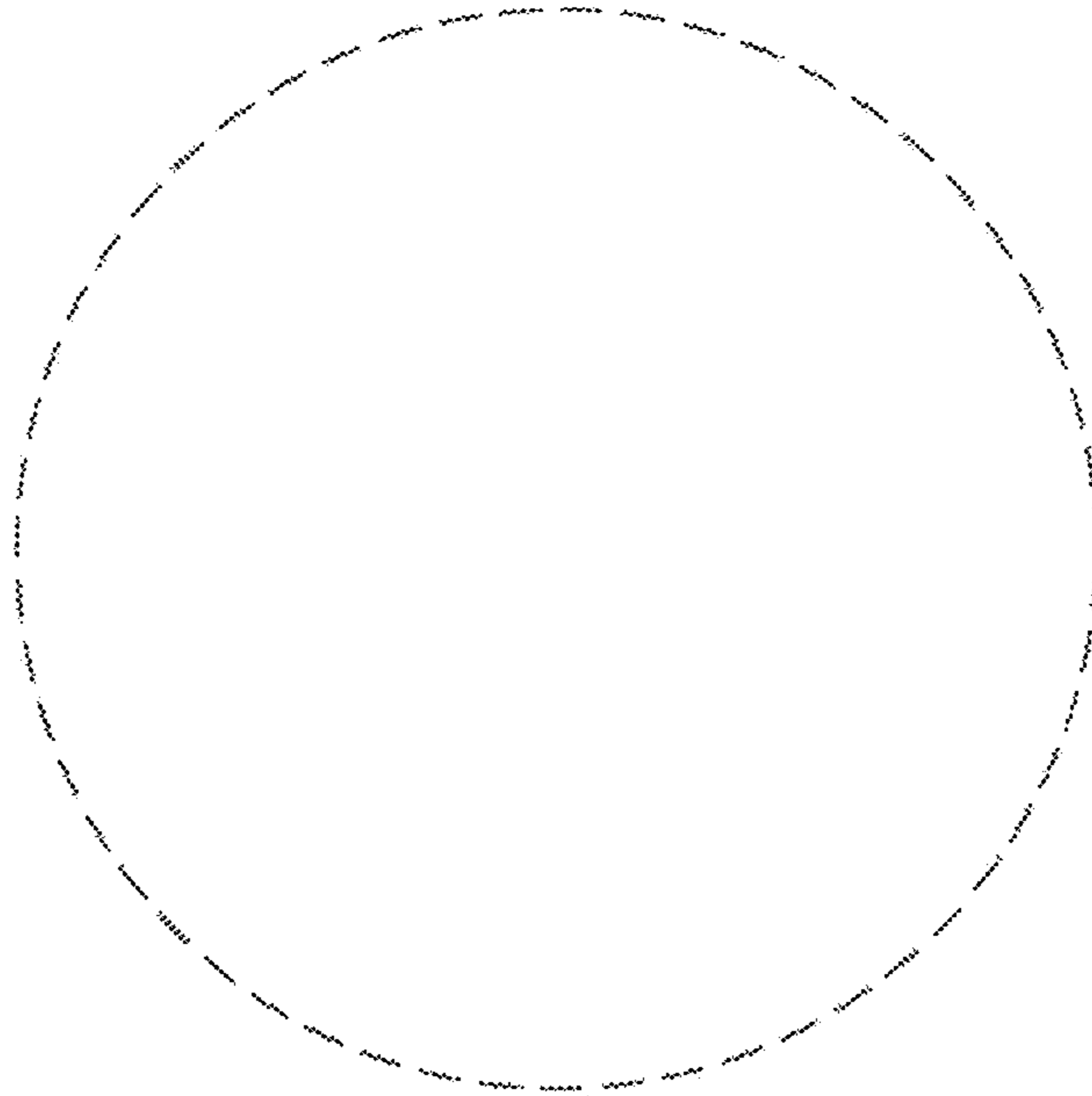
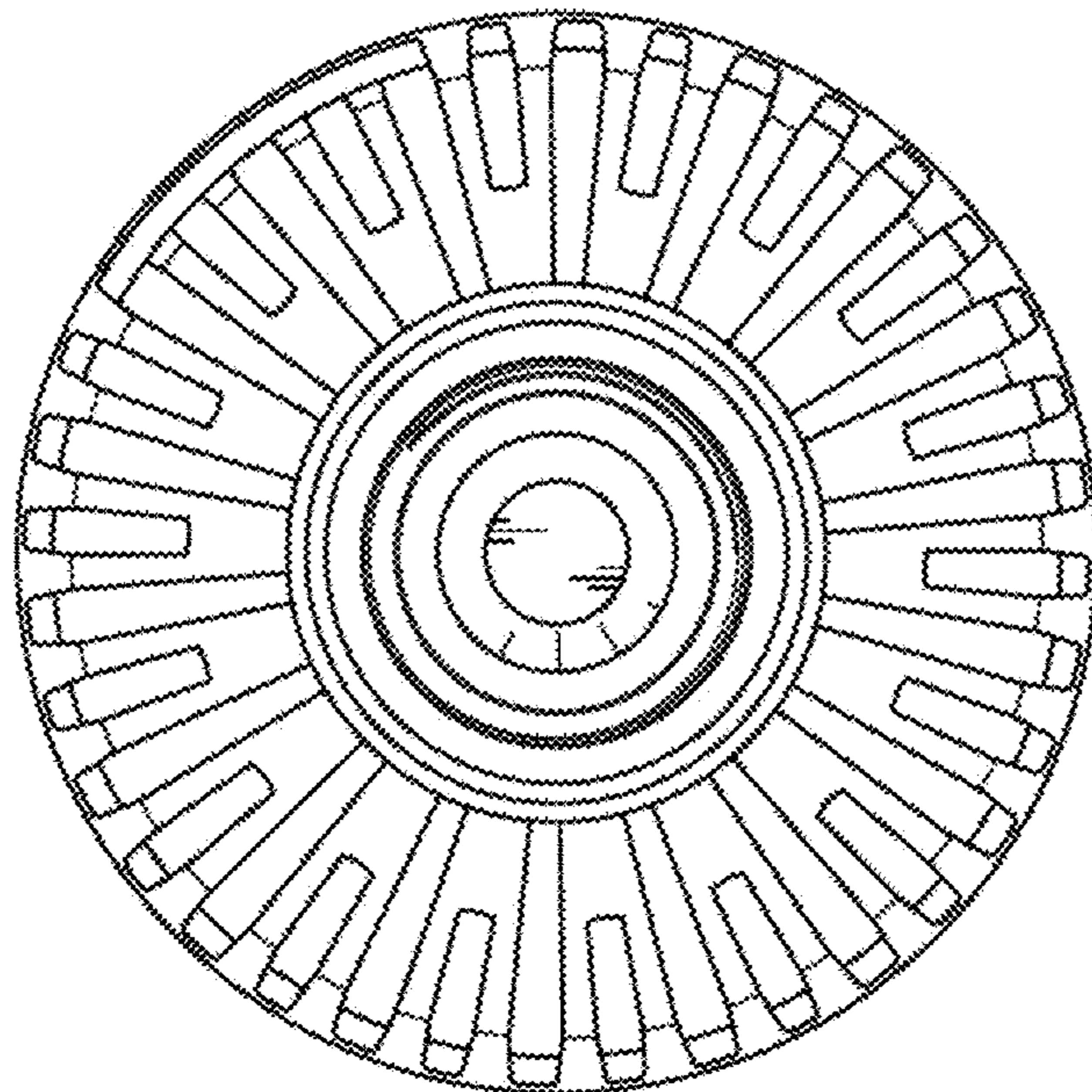


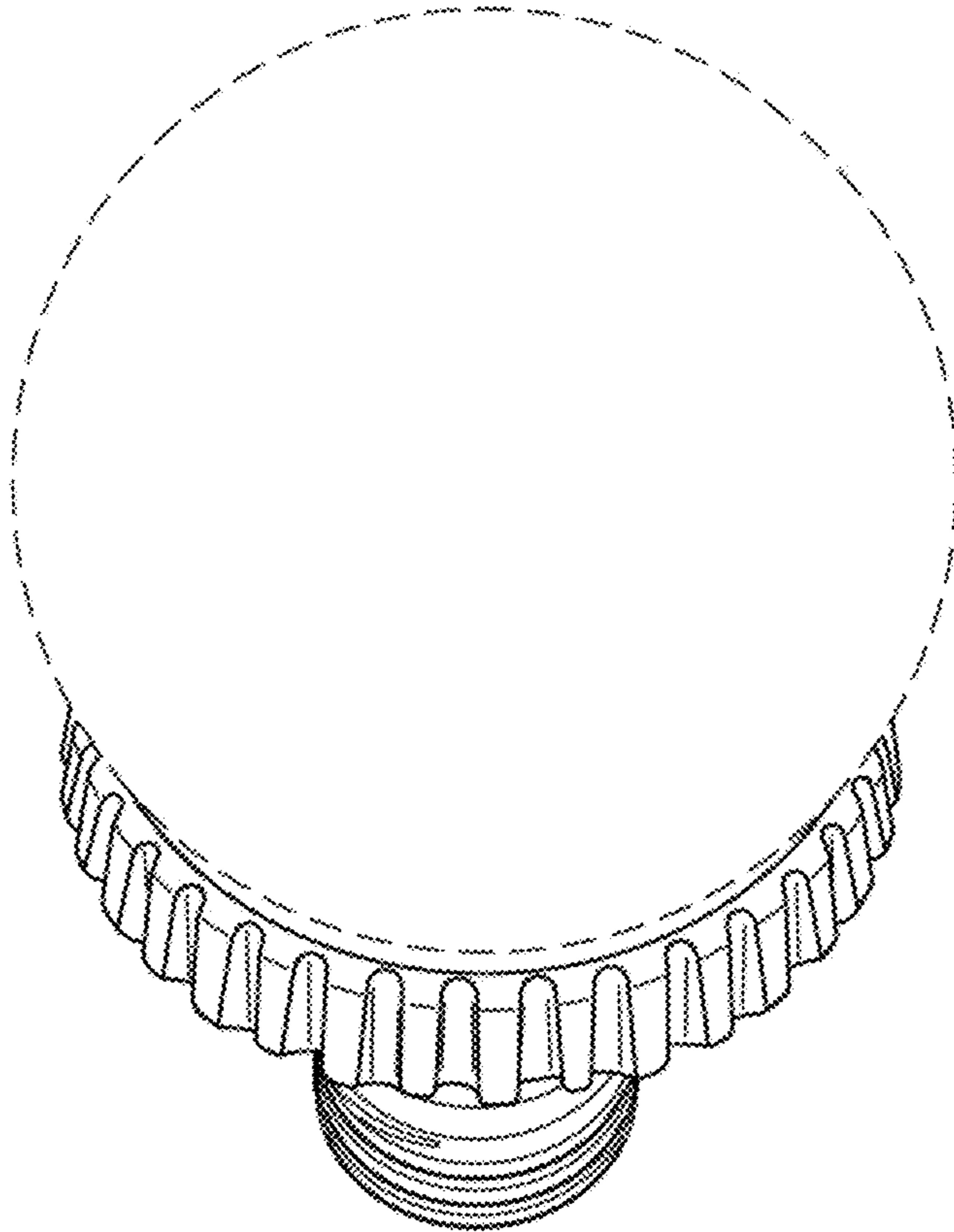
FIG. 6



**FIG. 7**

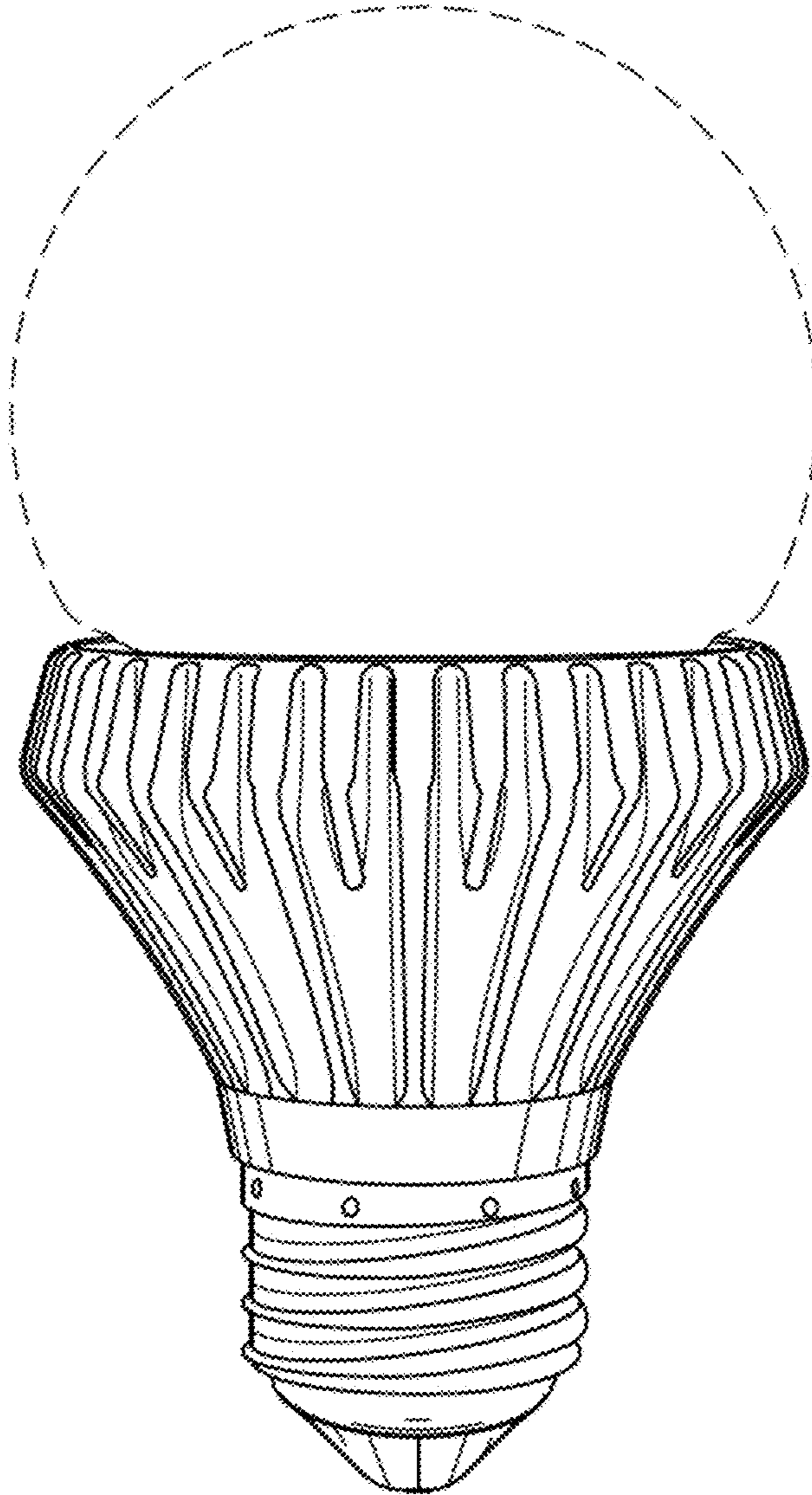


**FIG. 8**

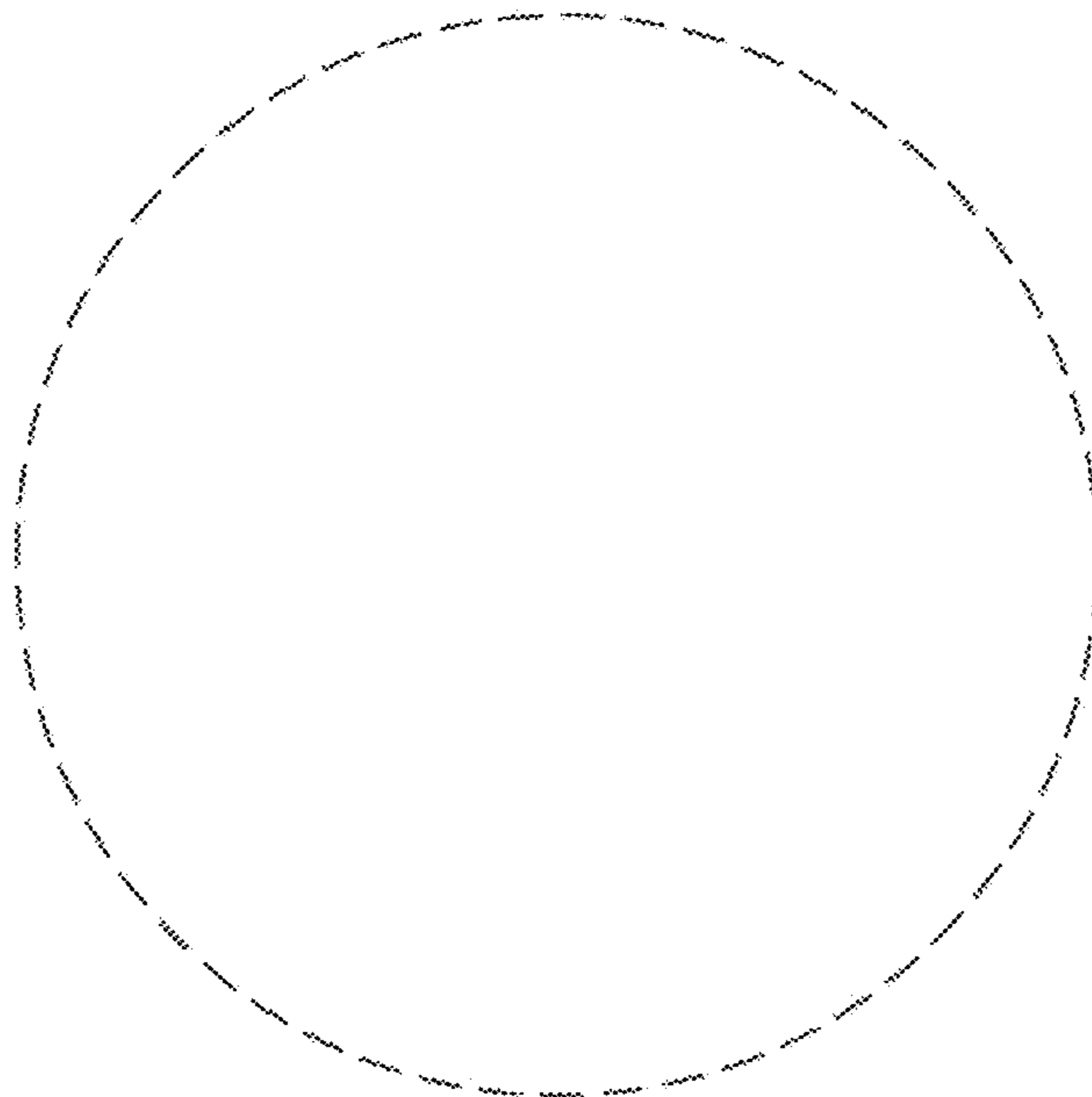


**FIG. 9**

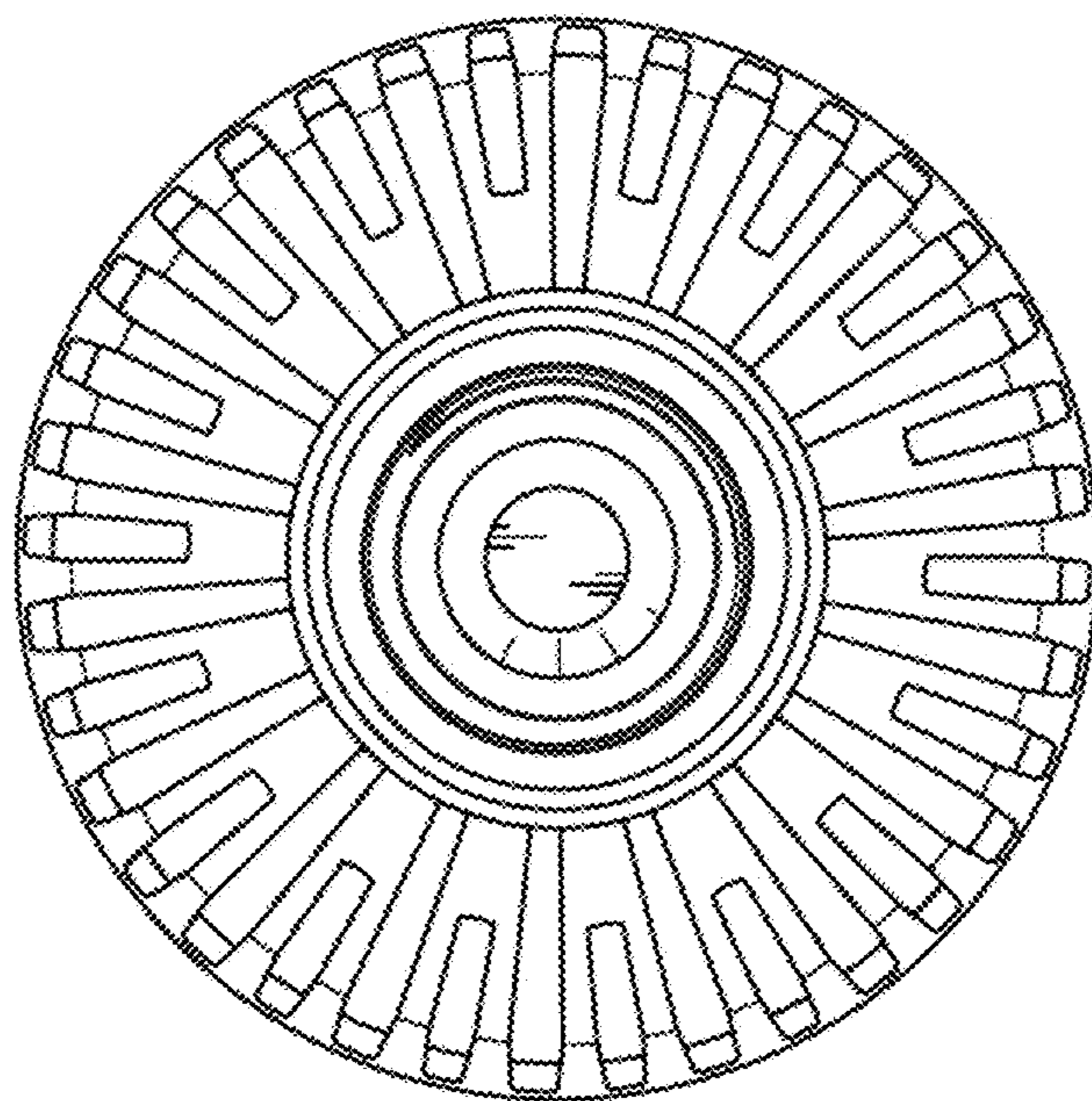




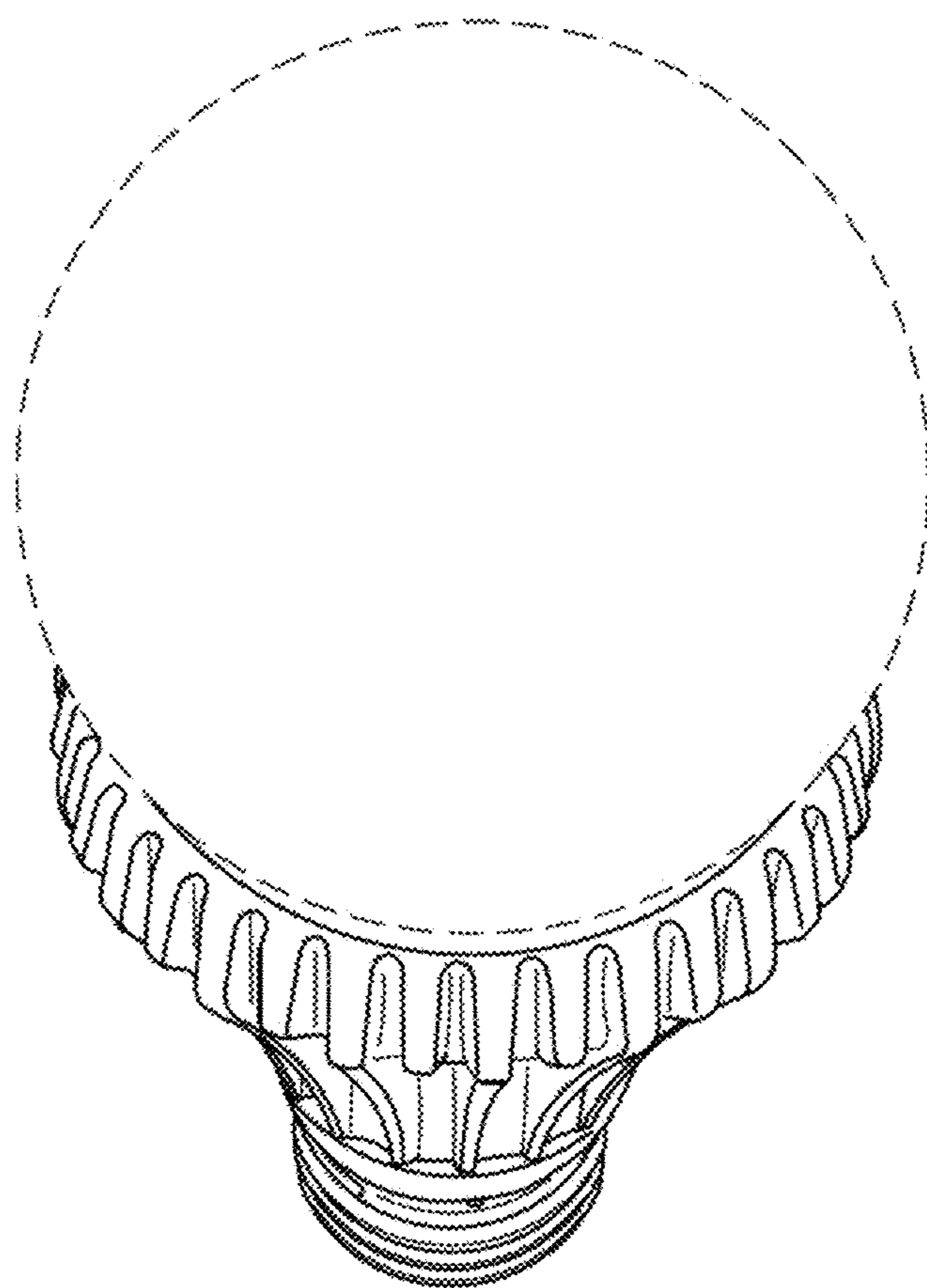
*FIG. 10*



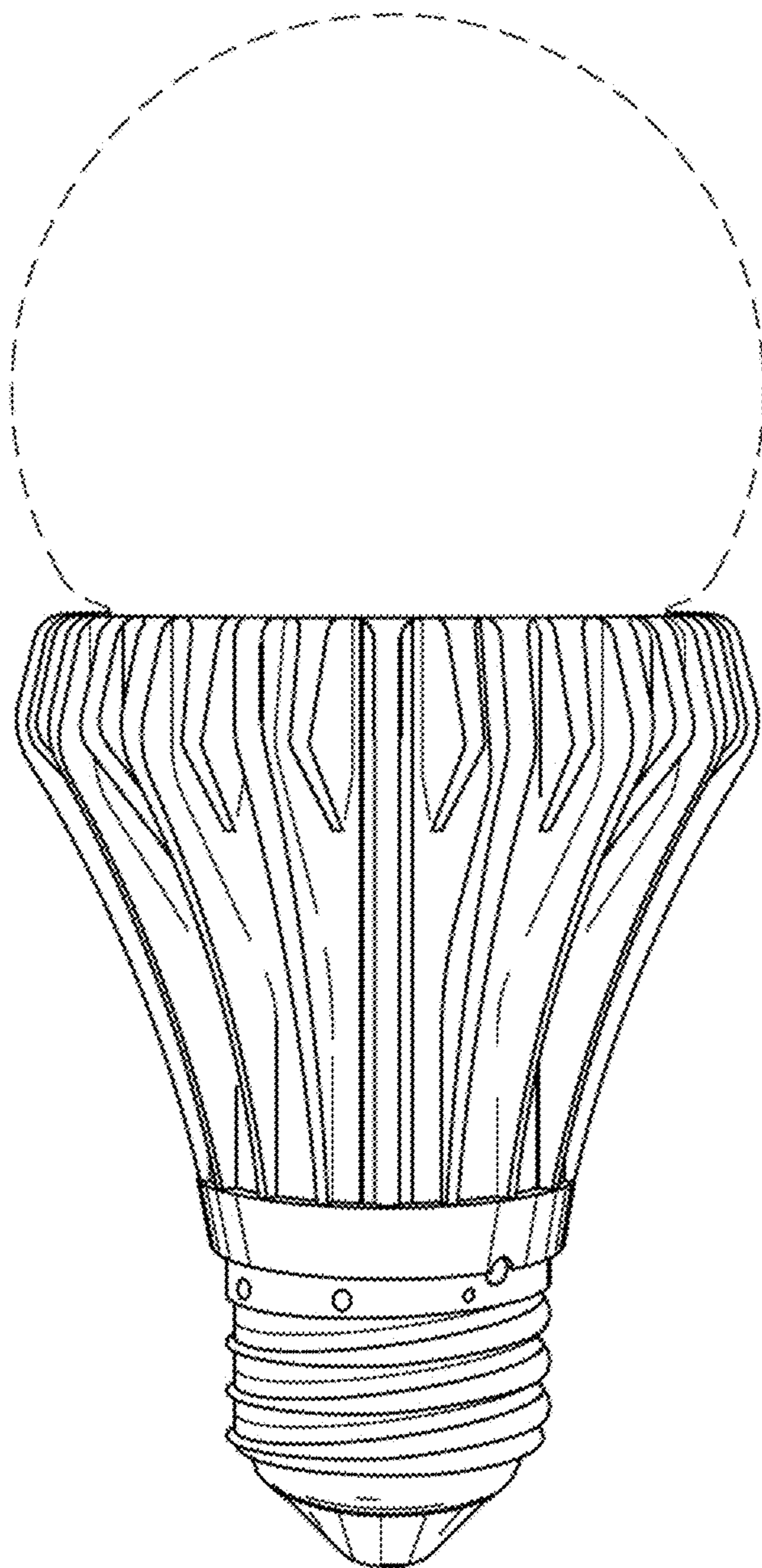
**FIG. 11**



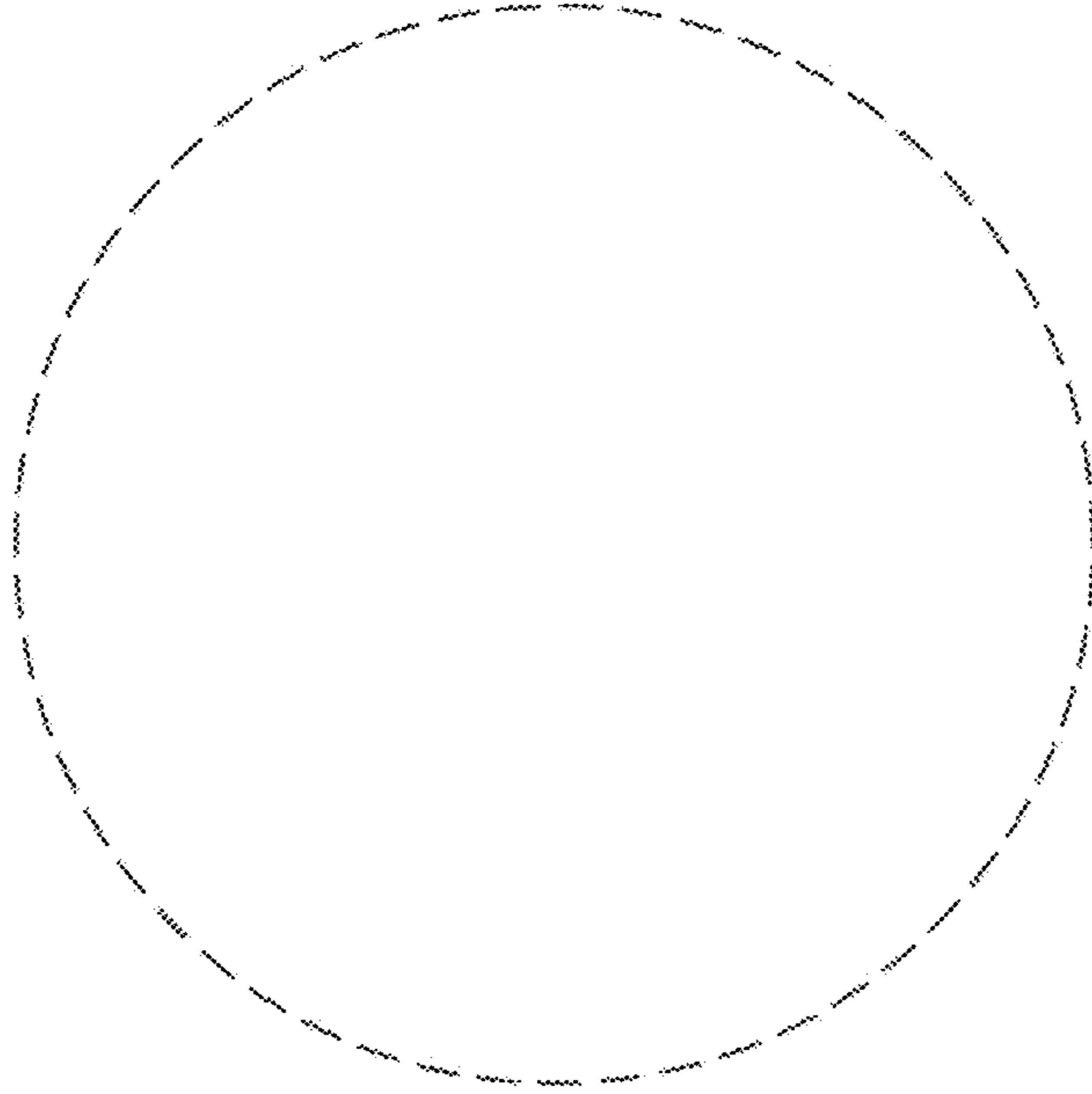
**FIG. 12**



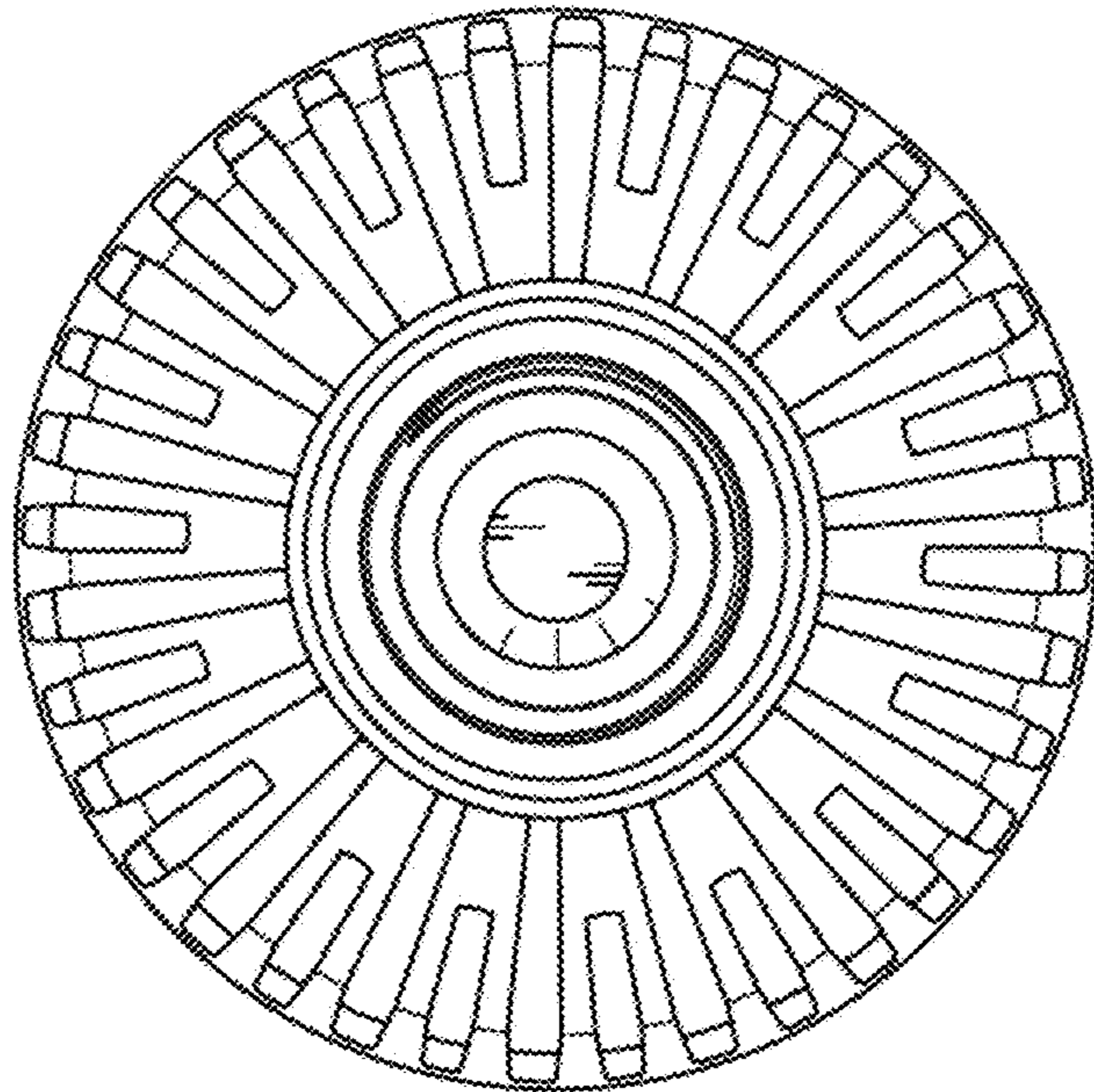
**FIG. 13**



**FIG. 14**



**FIG. 15**



**FIG. 16**