



US00D689589S

(12) **United States Design Patent**
Sheridan

(10) **Patent No.:** **US D689,589 S**
(45) **Date of Patent:** **** Sep. 10, 2013**

(54) **CURVED CORNER LANDSCAPE WATERFALL**

Sheridan; Corner Landscape Waterfall; Design U.S. Appl. No. 29/444,411, filed Jan. 30, 2013.

(71) Applicant: **Richard Sheridan**, Neptune, NJ (US)

* cited by examiner

(72) Inventor: **Richard Sheridan**, Neptune, NJ (US)

Primary Examiner — Robin V Webster

(**) Term: **14 Years**

(74) *Attorney, Agent, or Firm* — Patterson & Sheridan, LLP

(21) Appl. No.: **29/444,417**

(57) **CLAIM**

The ornamental design for a curved corner landscape waterfall, as shown and described.

(22) Filed: **Jan. 30, 2013**

DESCRIPTION

(51) **LOC (9) Cl.** **23-01**

FIG. 1 is a perspective view of a curved corner landscape waterfall illustrating water (shown in phantom) exiting an aperture and falling into a splash reducing material (also shown in phantom), the phantom lines forming no part of the claimed design.

(52) **U.S. Cl.**

USPC **D23/201**

FIG. 2 is a front side view of the curved corner landscape waterfall of FIG. 1.

(58) **Field of Classification Search**

USPC D23/201, 404; D11/131; 239/17-22

See application file for complete search history.

FIG. 3 is a back side view of the curved corner landscape waterfall of FIG. 1, and metalwork shown in phantom on the back side view forms no part of the claimed design.

(56) **References Cited**

U.S. PATENT DOCUMENTS

5,226,935	A	7/1993	Wolff et al.	
D470,215	S	2/2003	Lussier	
D491,250	S	6/2004	Raymond et al.	
D598,973	S	8/2009	Muhlethaler	
D643,505	S	8/2011	Haijin	
D671,190	S	* 11/2012	Sheridan D23/201

OTHER PUBLICATIONS

Sheridan; Freestanding Landscape Waterfall Assembly; U.S. Appl. No. 13/690,991, filed Nov. 30, 2012.

Sheridan; Landscape Waterfall; U.S. Appl. No. 13/768,612, filed Feb. 15, 2013.

FIG. 4 is a left side view of the curved corner landscape waterfall of FIG. 1, the right side view being identical.

FIG. 5 is a top side view of the curved corner landscape waterfall of FIG. 1, and metalwork shown in phantom on the top side view forms no part of the claimed design; and,

FIG. 6 is a bottom side view of the curved corner landscape waterfall of FIG. 1, and metalwork shown in phantom on the bottom side view forms no part of the claimed design.

The broken and phantom lines in the figures form no part of the claimed design.

1 Claim, 6 Drawing Sheets

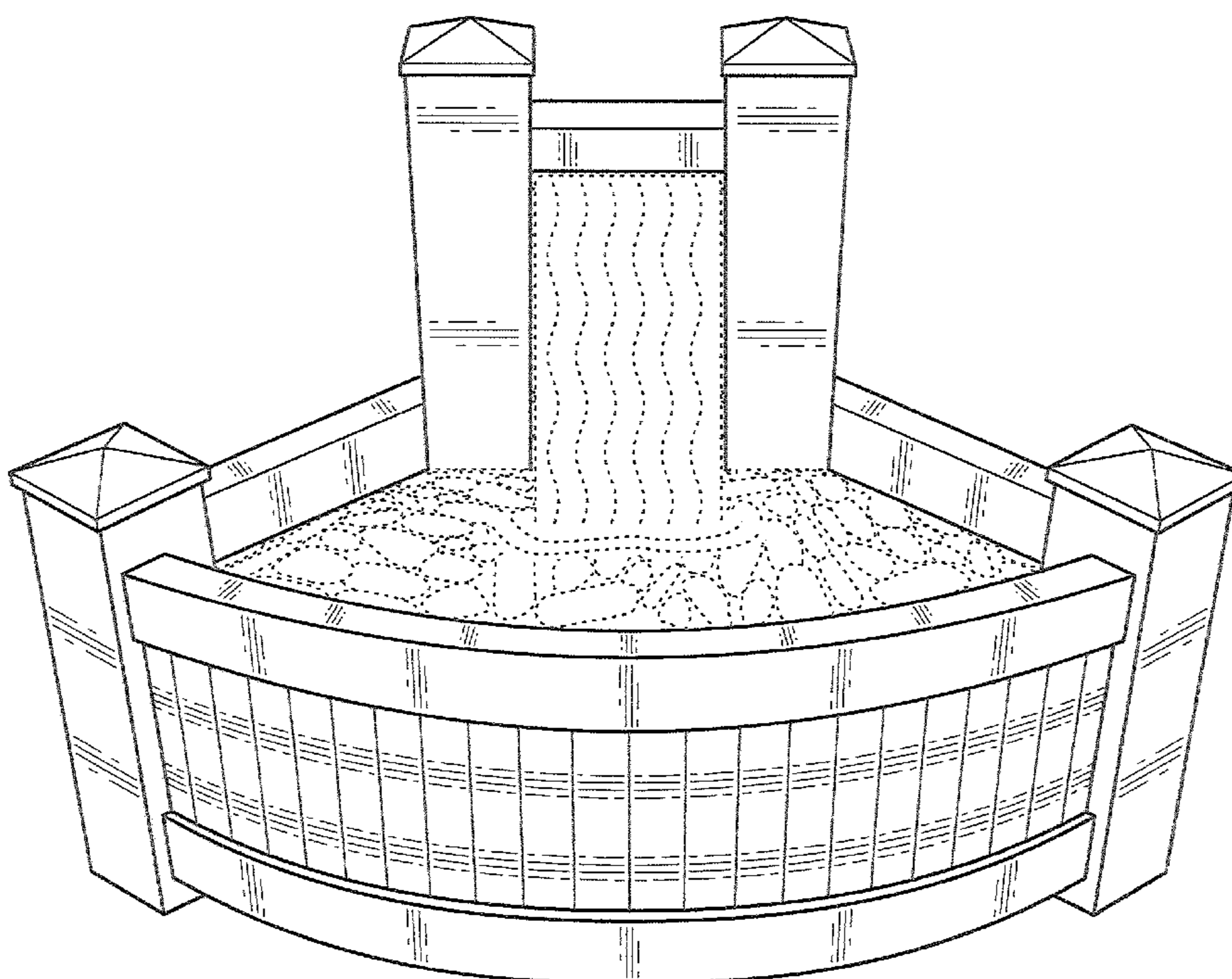

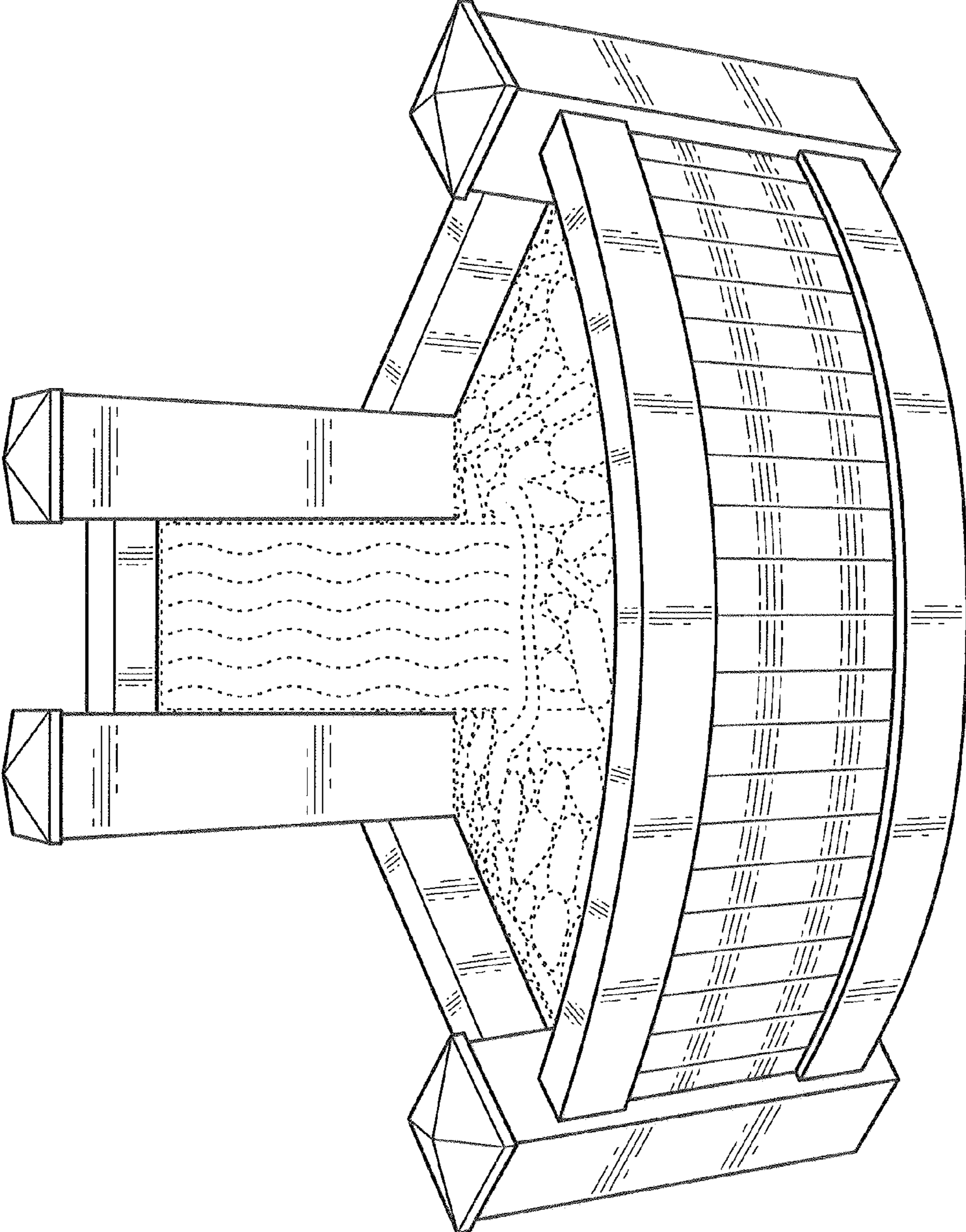

FIG. 1

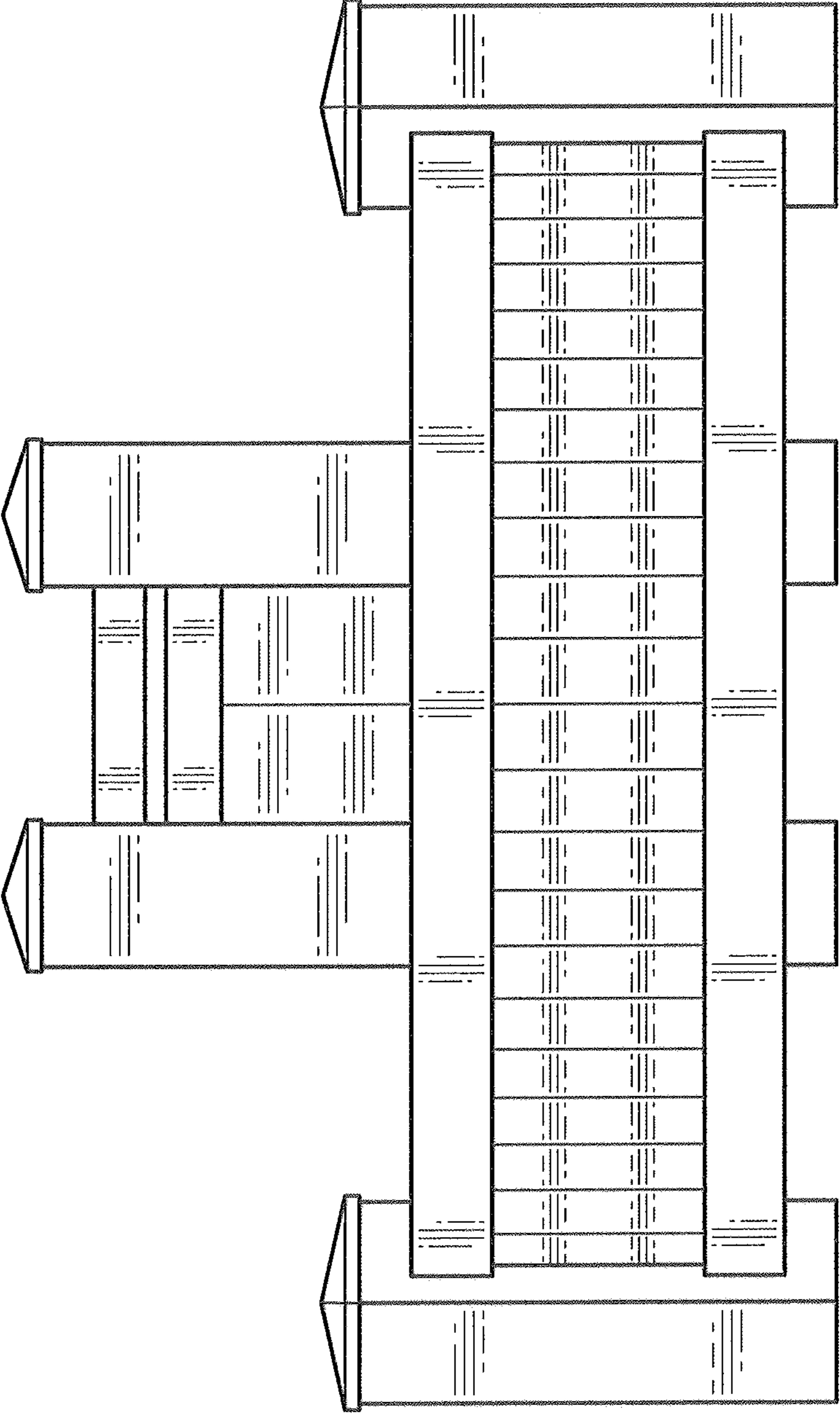

FIG. 2

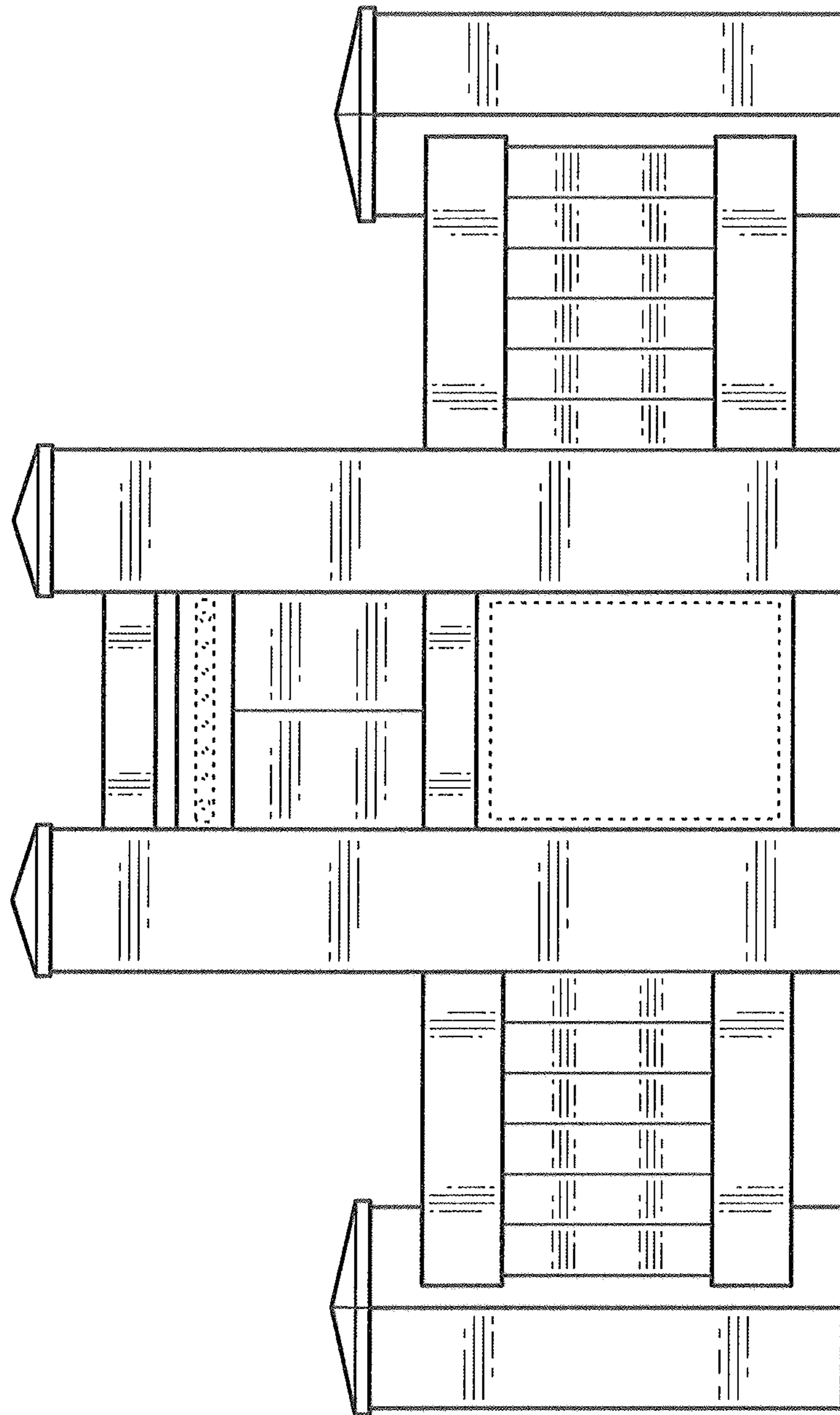

FIG. 3

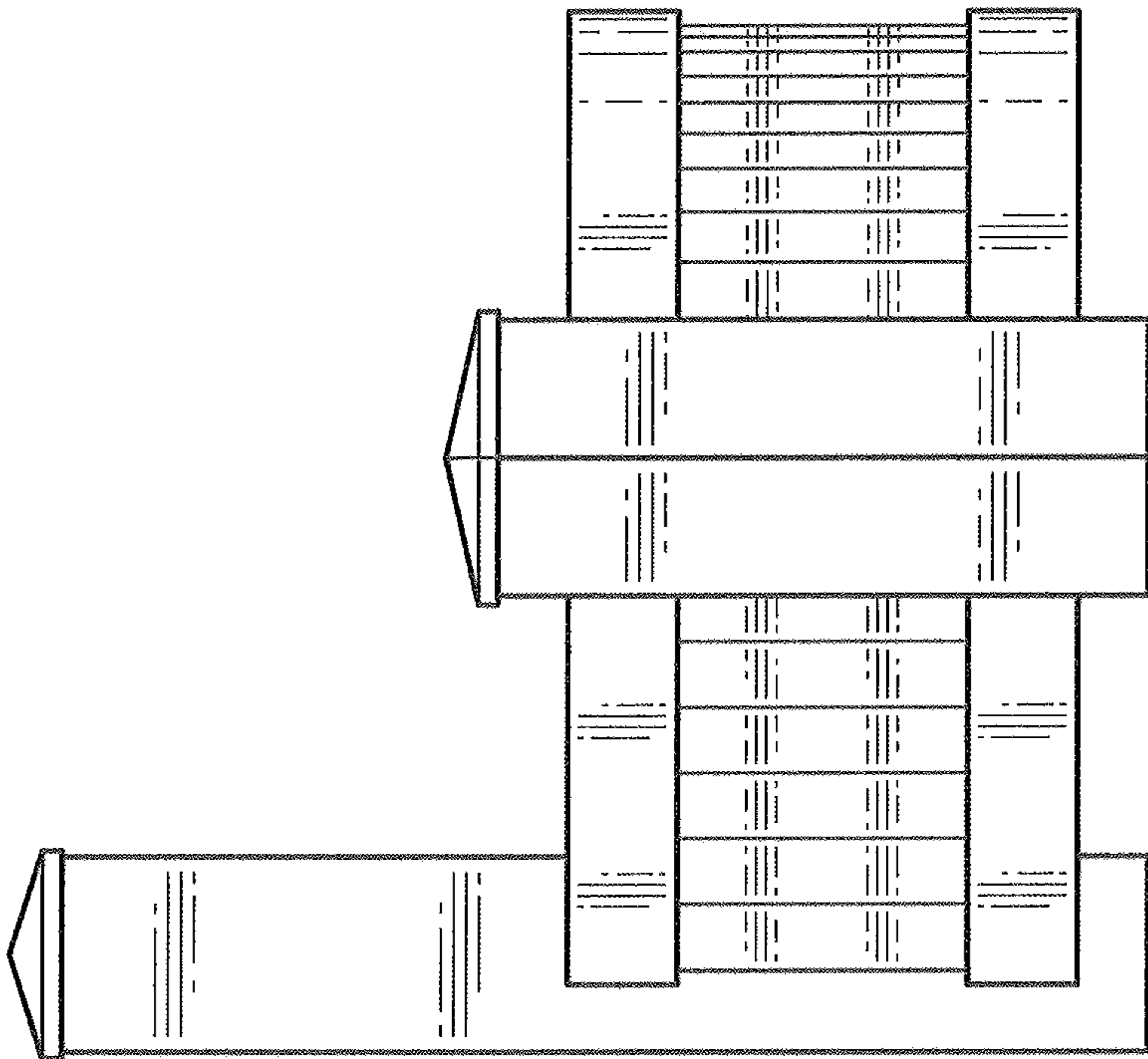

FIG. 4

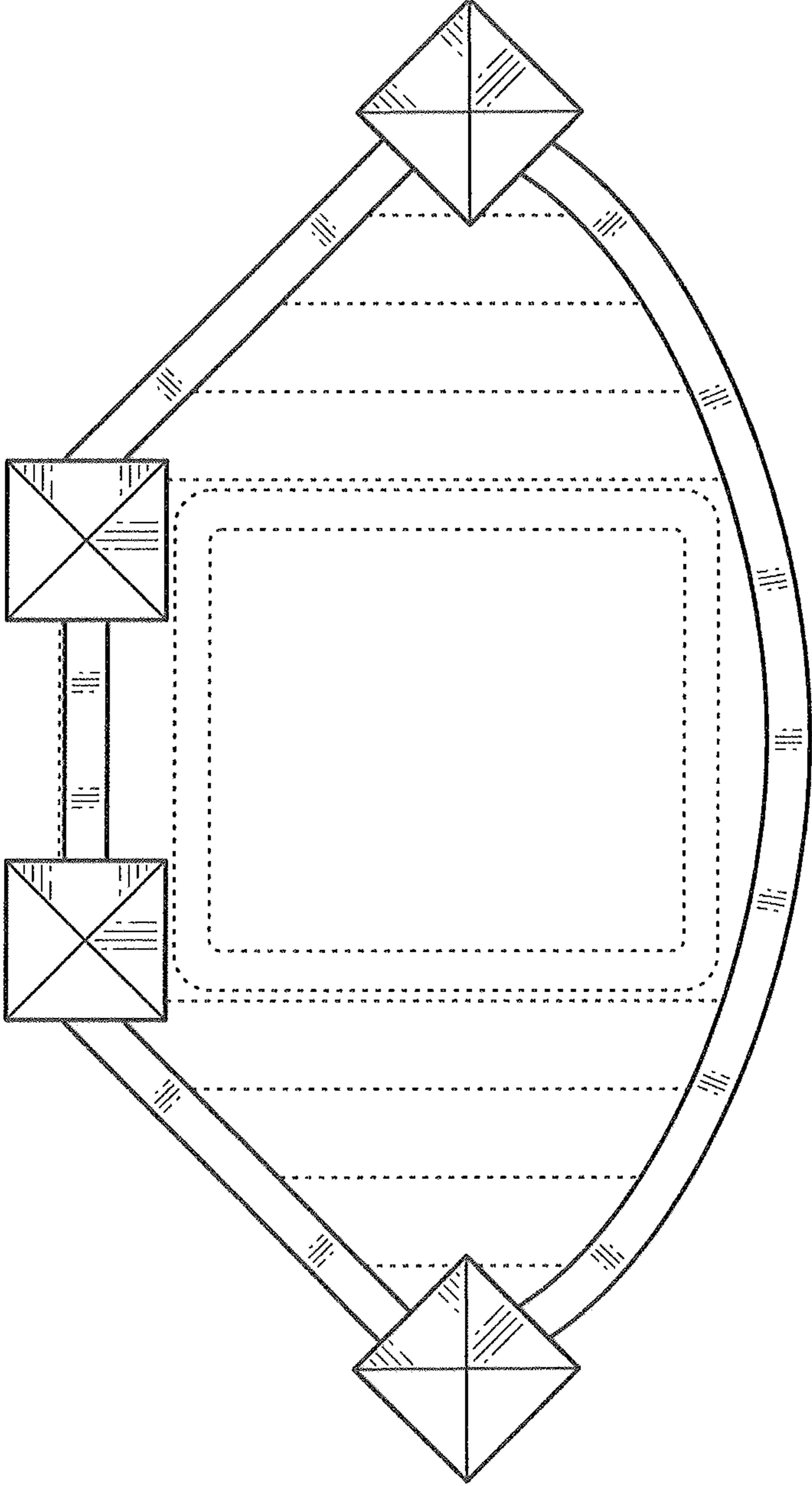

FIG. 5

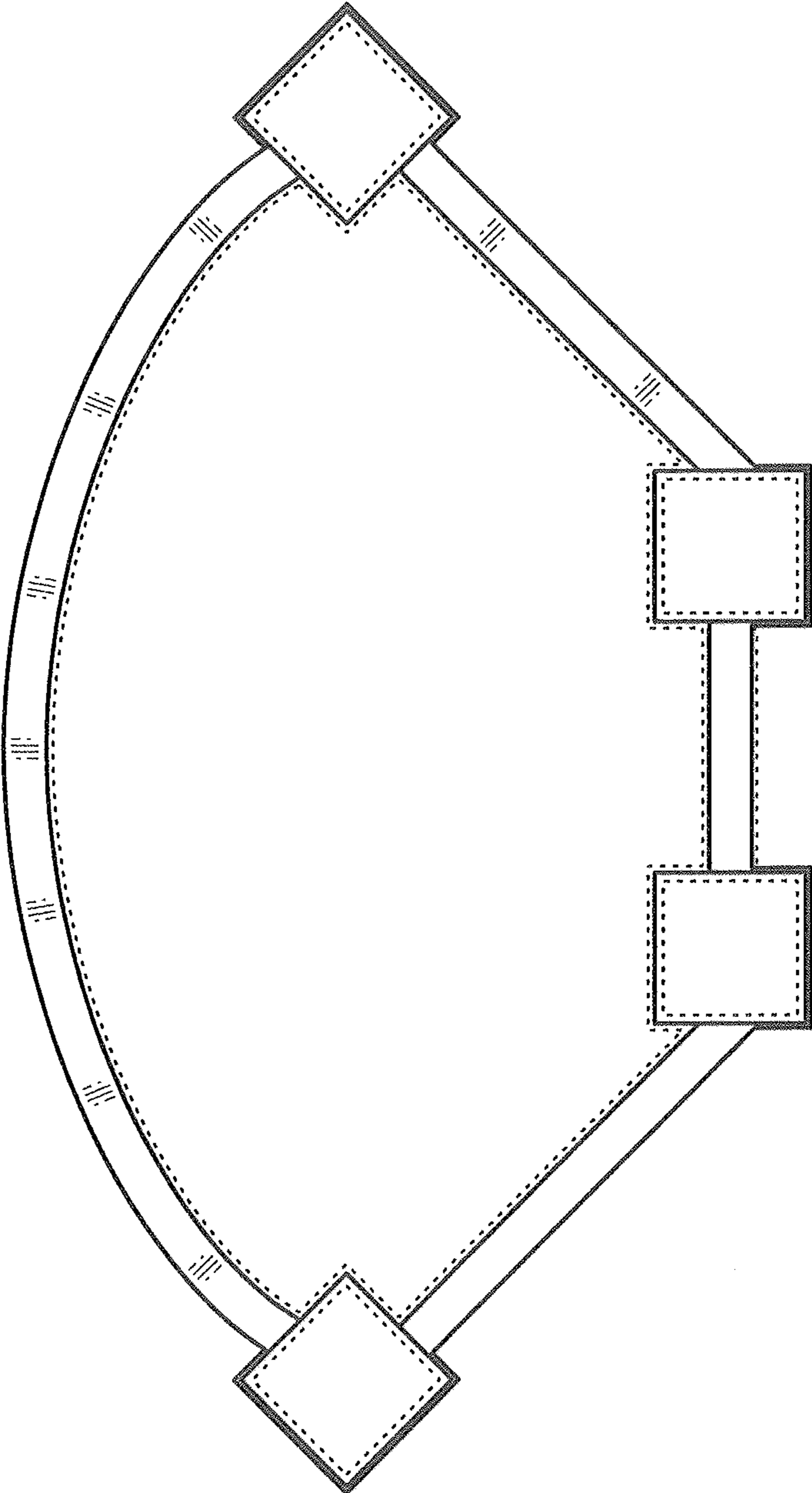

FIG. 6