



US00D689573S

(12) **United States Design Patent**
Severa et al.

(10) **Patent No.:** **US D689,573 S**

(45) **Date of Patent:** **** Sep. 10, 2013**

(54) **THROAT OF A RACQUET**

5,324,030 A * 6/1994 Tsou 473/521
D355,232 S * 2/1995 Hodges D21/730
D367,904 S * 3/1996 Hodges D21/730

(75) Inventors: **William D. Severa**, Darien, IL (US);
Robert T. Kapheim, Chicago, IL (US);
Ronald R. Rocchi, Naperville, IL (US);
Brad M. Skoryl, Palos Heights, IL (US);
Ravi Itiravivong, Evanston, IL (US);
Scott M. Doyle, Oak Park, IL (US)

* cited by examiner

Primary Examiner — Mitchell Siegel

(74) *Attorney, Agent, or Firm* — Terence P. O'Brien

(73) Assignee: **Wilson Sporting Goods Co.**, Chicago, IL (US)

(57) **CLAIM**

We claim the ornamental design for a throat of a racquet, as shown and described.

(**) Term: **14 Years**

DESCRIPTION

(21) Appl. No.: **29/429,419**

FIG. 1 is a front perspective view of a throat of a racquet; FIG. 2 is an enlarged front perspective view of the throat of the racquet of FIG. 1; FIG. 3 is an enlarged bottom, side perspective view of the throat of the racquet of FIG. 1; FIG. 4 is a front view of the throat of the racquet of FIG. 1; FIG. 5 is a side view of the throat of the racquet of FIG. 1; FIG. 6 is a top view of the throat of the racquet taken along line 6°-°6° of FIG. 4; FIG. 7 is a top view of the throat of the racquet taken along line 7°-°7° of FIG. 4; and, FIG. 8 is a bottom view of the throat of the racquet taken along line 8°-°8° of FIG. 4.

(22) Filed: **Aug. 10, 2012**

(51) **LOC (9) Cl.** **21-02**

(52) **U.S. Cl.**
USPC **D21/730**

(58) **Field of Classification Search**
USPC D21/729-731; 473/524-557
See application file for complete search history.

The ornamental design that is claimed is shown in solid lines in the drawings. The broken (dashed) lines shown in FIGS. 1 through 5 and 8 are included for the purpose of illustrating environmental elements only and form no part of the claimed design.

(56) **References Cited**

U.S. PATENT DOCUMENTS

D81,875 S * 8/1930 Hall D21/730
3,990,700 A * 11/1976 Robinson 473/534
D243,354 S * 2/1977 Witte et al. D21/753
D253,713 S * 12/1979 Robinson et al. D21/730
D259,650 S * 6/1981 Fiott D21/730
D286,902 S * 11/1986 Tilley D21/730
5,282,617 A * 2/1994 Hong 473/546

1 Claim, 6 Drawing Sheets

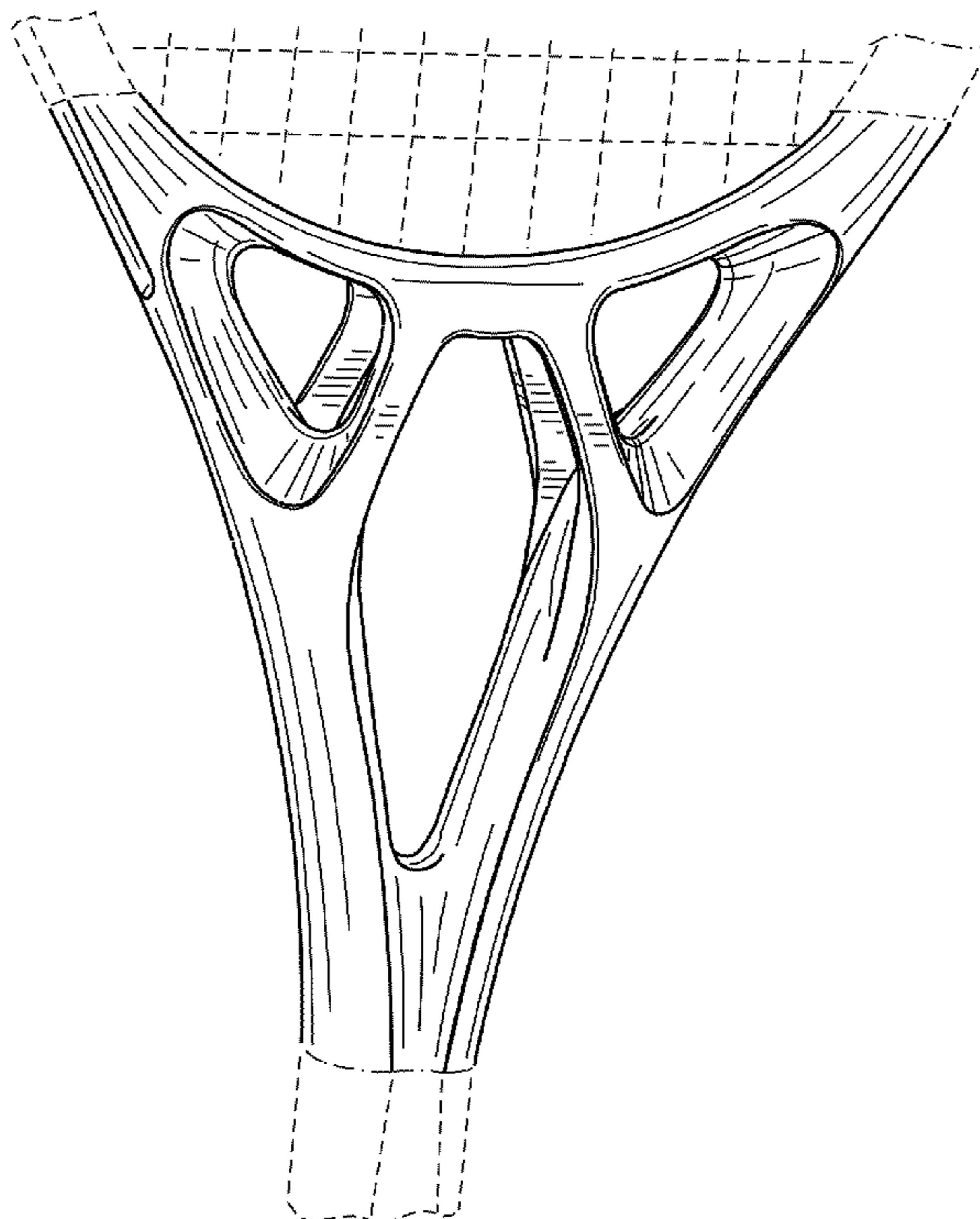

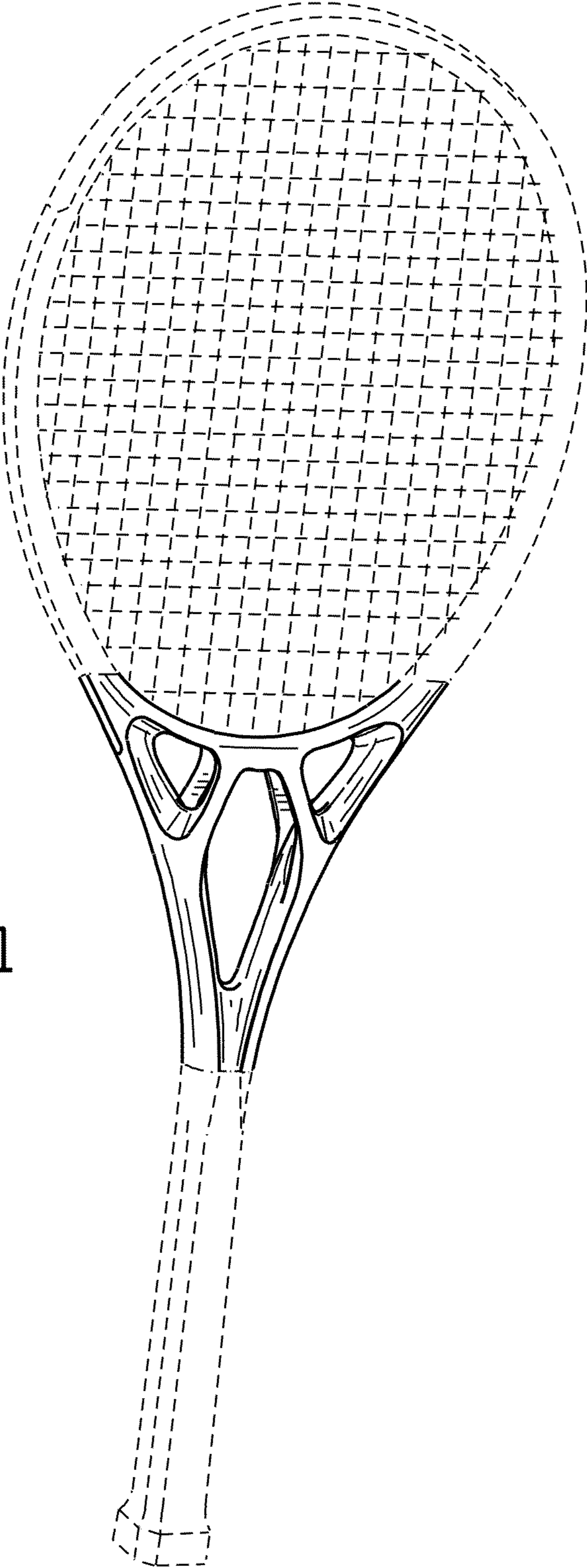

FIG. 1

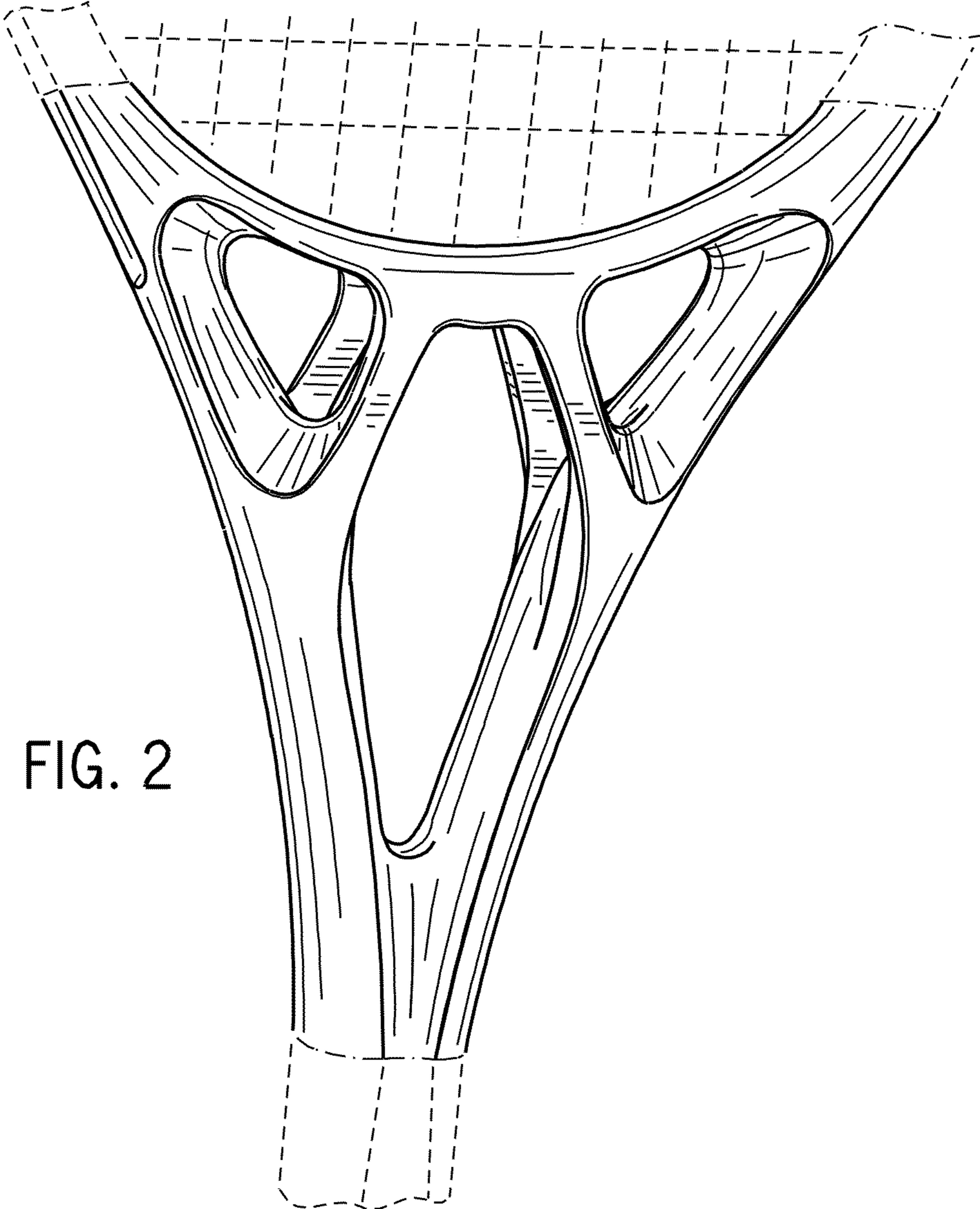

FIG. 2

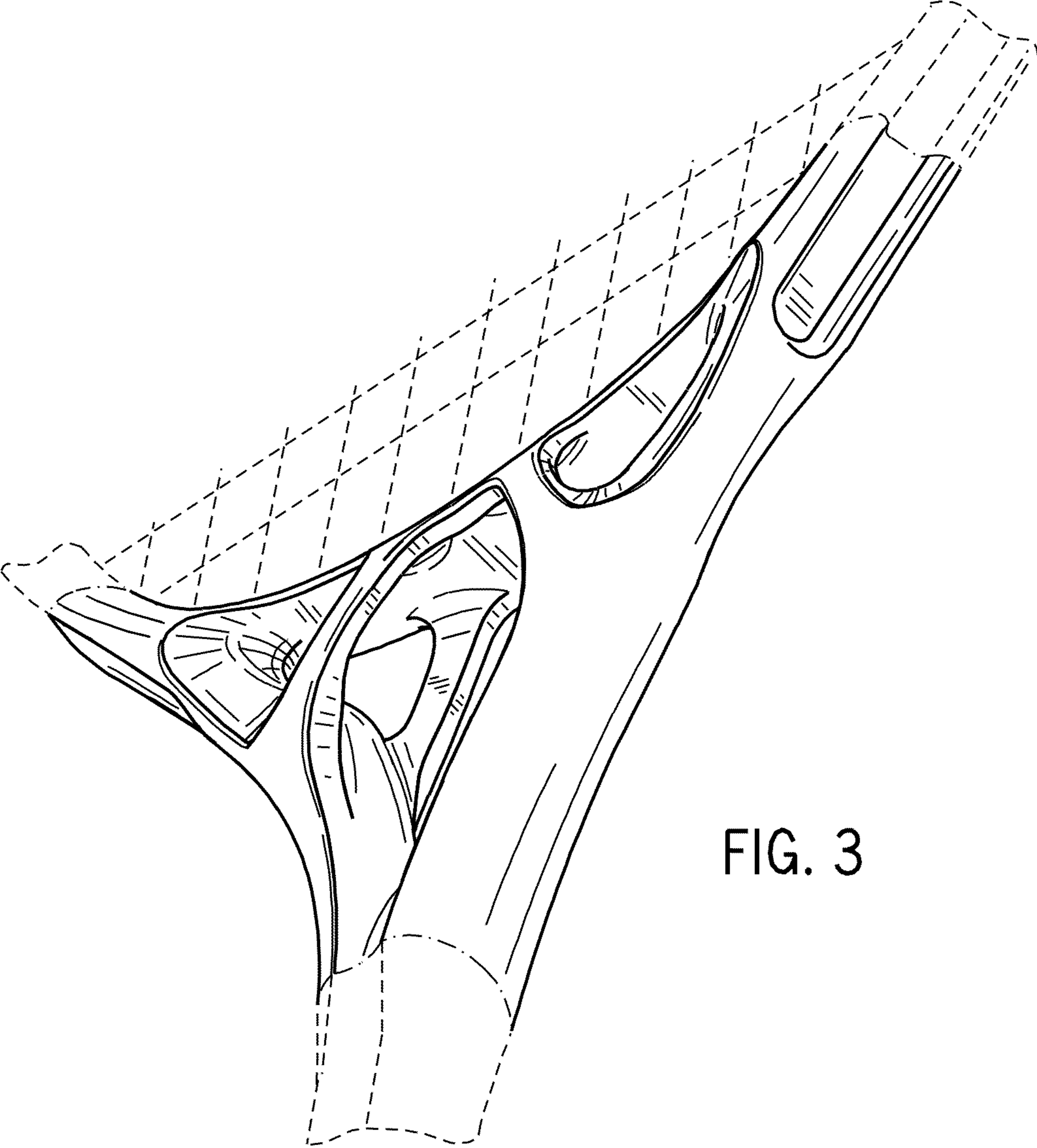

FIG. 3

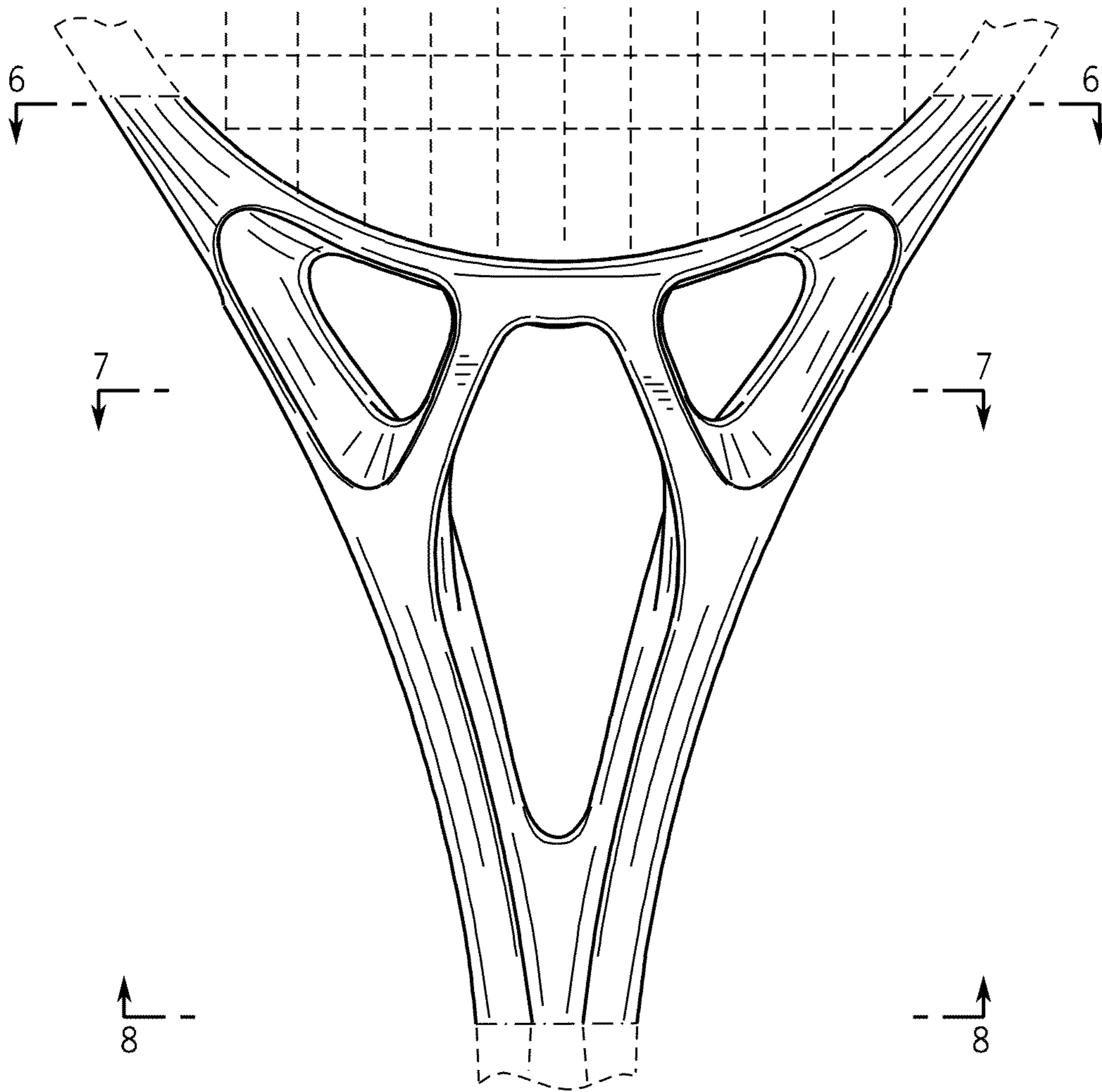

FIG. 4

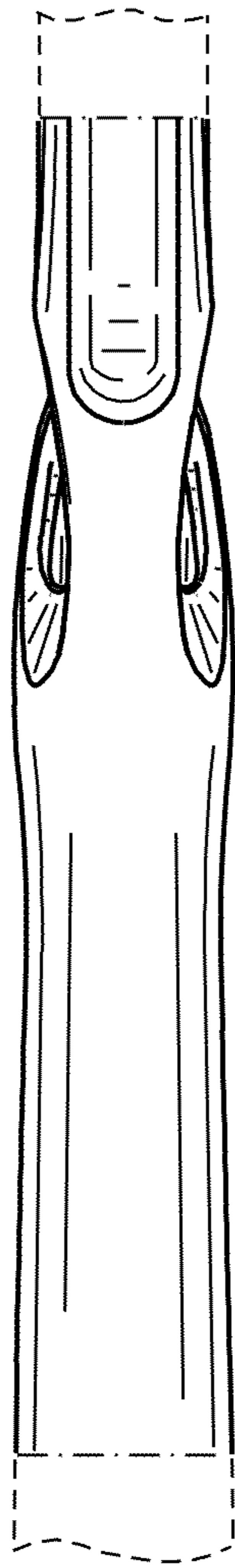

FIG. 5

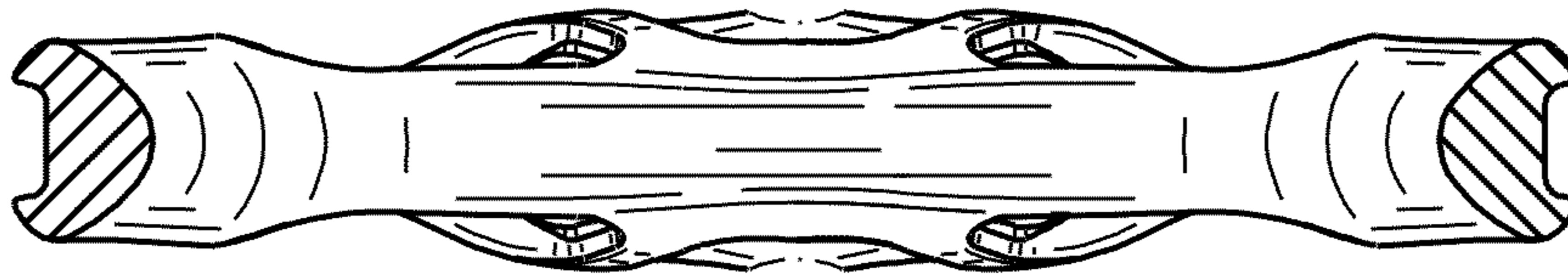

FIG. 6

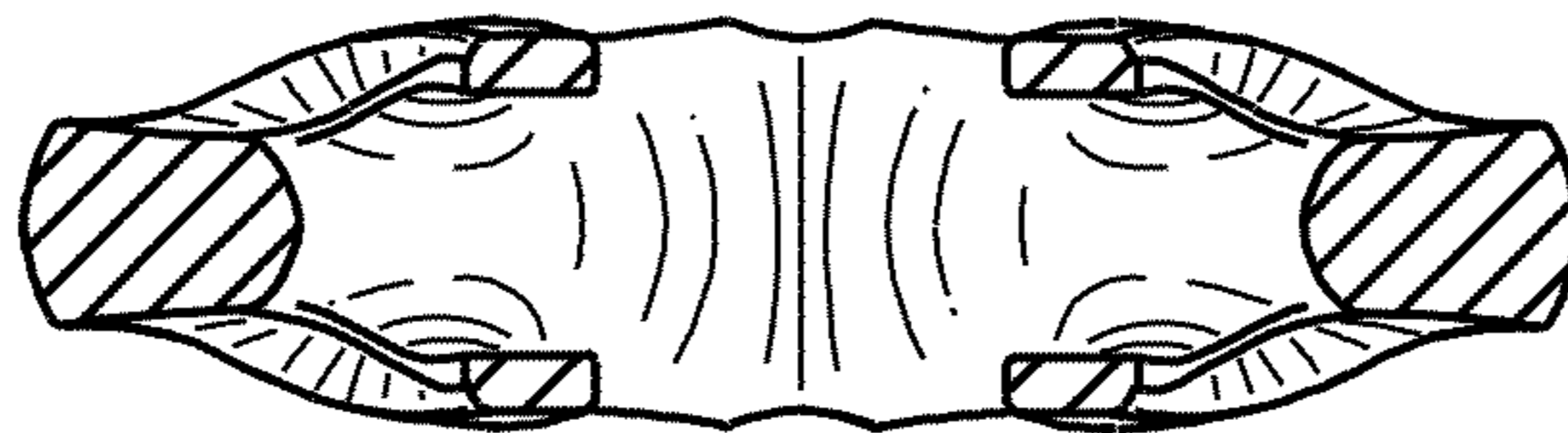

FIG. 7

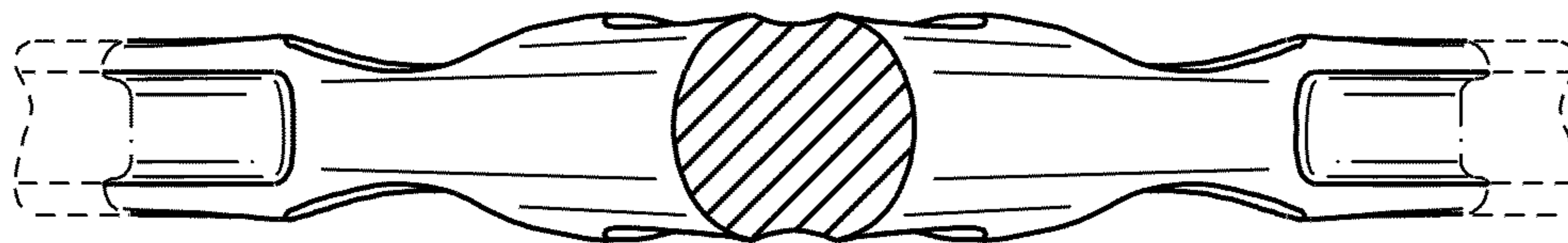

FIG. 8