



US00D689551S

(12) **United States Design Patent**
Shafer

(10) **Patent No.:** **US D689,551 S**

(45) **Date of Patent:** **** Sep. 10, 2013**

- (54) **HANGING FILE HOLDER**
- (71) Applicant: **Deflecto, LLC**, Indianapolis, IN (US)
- (72) Inventor: **Rich Shafer**, Indianapolis, IN (US)
- (73) Assignee: **Deflecto, LLC**, Indianapolis, IN (US)
- (**) Term: **14 Years**
- (21) Appl. No.: **29/437,765**
- (22) Filed: **Nov. 20, 2012**
- (51) **LOC (9) Cl.** **19-02**
- (52) **U.S. Cl.**
USPC **D19/90**
- (58) **Field of Classification Search**
USPC D3/273, 294, 304, 314; D6/310,
D6/311, 312, 676.3, 678.3, 683.1, 700; D9/432;
D19/26-31, 75, 77, 78, 81-86, 90, 91; 206/215,
206/425, 449, 555; 211/10, 11, 46, 48, 87.01;
248/447, 454, 460, 461, 462, 463; D14/447
See application file for complete search history.

| | | | | |
|--------------|---------|---------------|-------|--------|
| D433,548 S * | 11/2000 | Baines et al. | | D32/37 |
| D436,253 S * | 1/2001 | Licari | | D3/321 |
| D481,075 S * | 10/2003 | Chang | | D19/90 |
| D486,619 S * | 2/2004 | Rivera et al. | | D34/19 |
| D518,526 S * | 4/2006 | Benn | | D19/90 |
| D533,327 S * | 12/2006 | McCaskill | | D34/17 |
| D554,189 S * | 10/2007 | Chen et al. | | D19/90 |
| D604,769 S * | 11/2009 | Chen et al. | | D19/90 |
| D665,846 S * | 8/2012 | Chuang | | D19/90 |

* cited by examiner

Primary Examiner — Elizabeth Albert

(74) *Attorney, Agent, or Firm* — SNR Denton US LLP;
Brian R. McGinley

(57) **CLAIM**

The ornamental design for a hanging file holder, as shown and described.

DESCRIPTION

FIG. 1 is a front perspective view of the hanging file holder illustrating the new design;
 FIG. 2 is a bottom perspective view of the hanging file holder illustrated in FIG. 1;
 FIG. 3 is a front view of the hanging file holder shown in FIG. 1;
 FIG. 4 is a rear view of the hanging file holder shown in FIG. 1;
 FIG. 5 is a right-side view of the hanging file holder shown in FIG. 1 which is a mirror image of the left-side view;
 FIG. 6 is a top view of the hanging file holder shown in FIG. 1;
 FIG. 7 is a section view of the hanging file holder shown in FIG. 6; and,
 FIG. 8 is a bottom view of the hanging file holder shown in FIG. 1.

1 Claim, 7 Drawing Sheets

(56) **References Cited**

U.S. PATENT DOCUMENTS

| | | | | |
|---------------|---------|------------|-------|-----------|
| 2,916,161 A * | 12/1959 | Schaefer | | 211/126.2 |
| D243,068 S * | 1/1977 | Verni | | D3/312 |
| D289,181 S * | 4/1987 | Solomon | | D19/90 |
| D307,499 S * | 4/1990 | Box | | D3/312 |
| D314,656 S * | 2/1991 | Box | | D3/312 |
| D326,550 S * | 5/1992 | Waterman | | D3/304 |
| D335,309 S * | 5/1993 | Evenson | | D19/90 |
| D351,621 S * | 10/1994 | Terzian | | D19/90 |
| D352,581 S * | 11/1994 | Fredericks | | D34/1 |
| D372,583 S * | 8/1996 | Brightbill | | D3/314 |
| D392,431 S * | 3/1998 | Schallern | | D32/37 |
| D401,024 S * | 11/1998 | Seymour | | D32/37 |

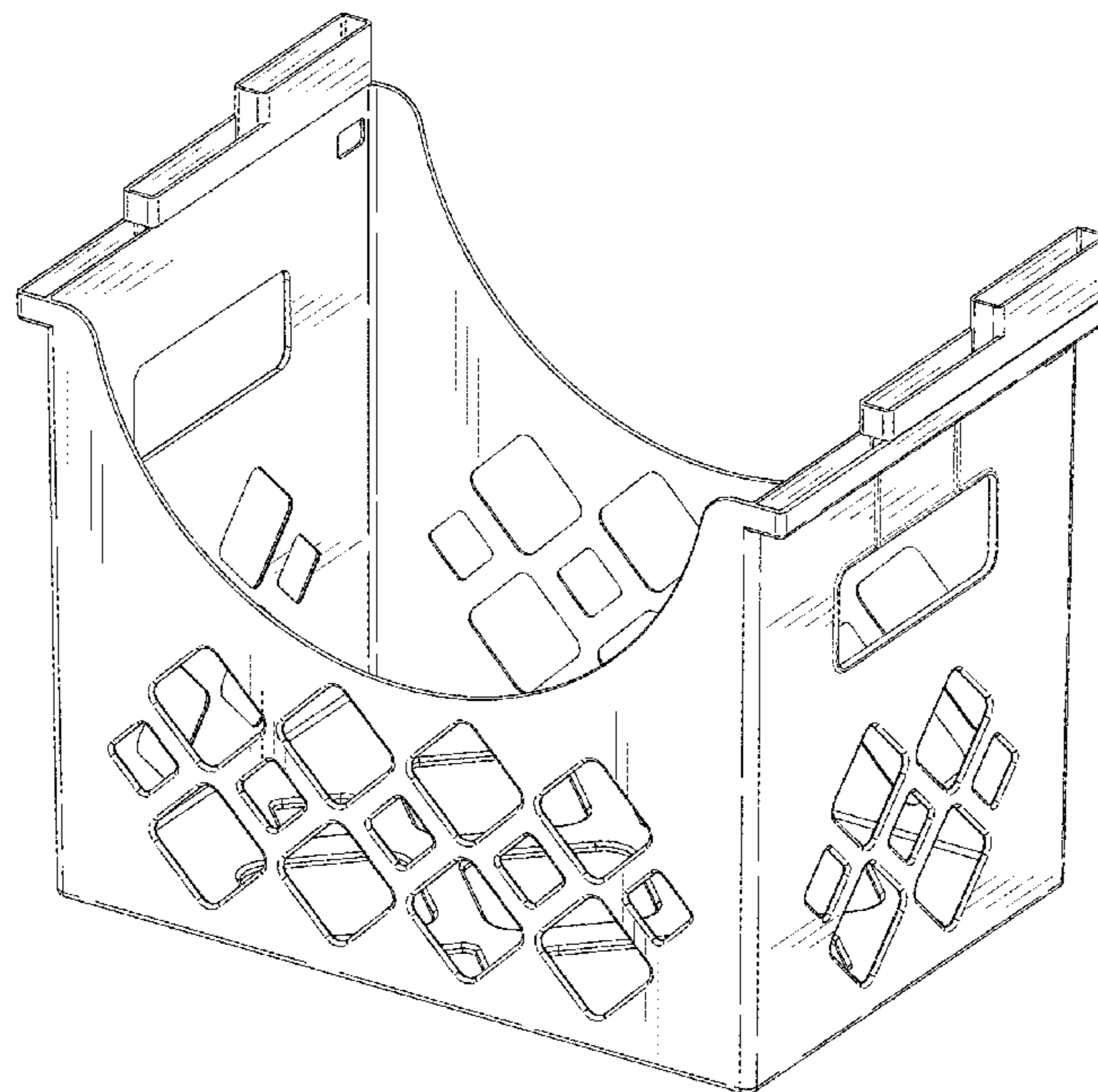

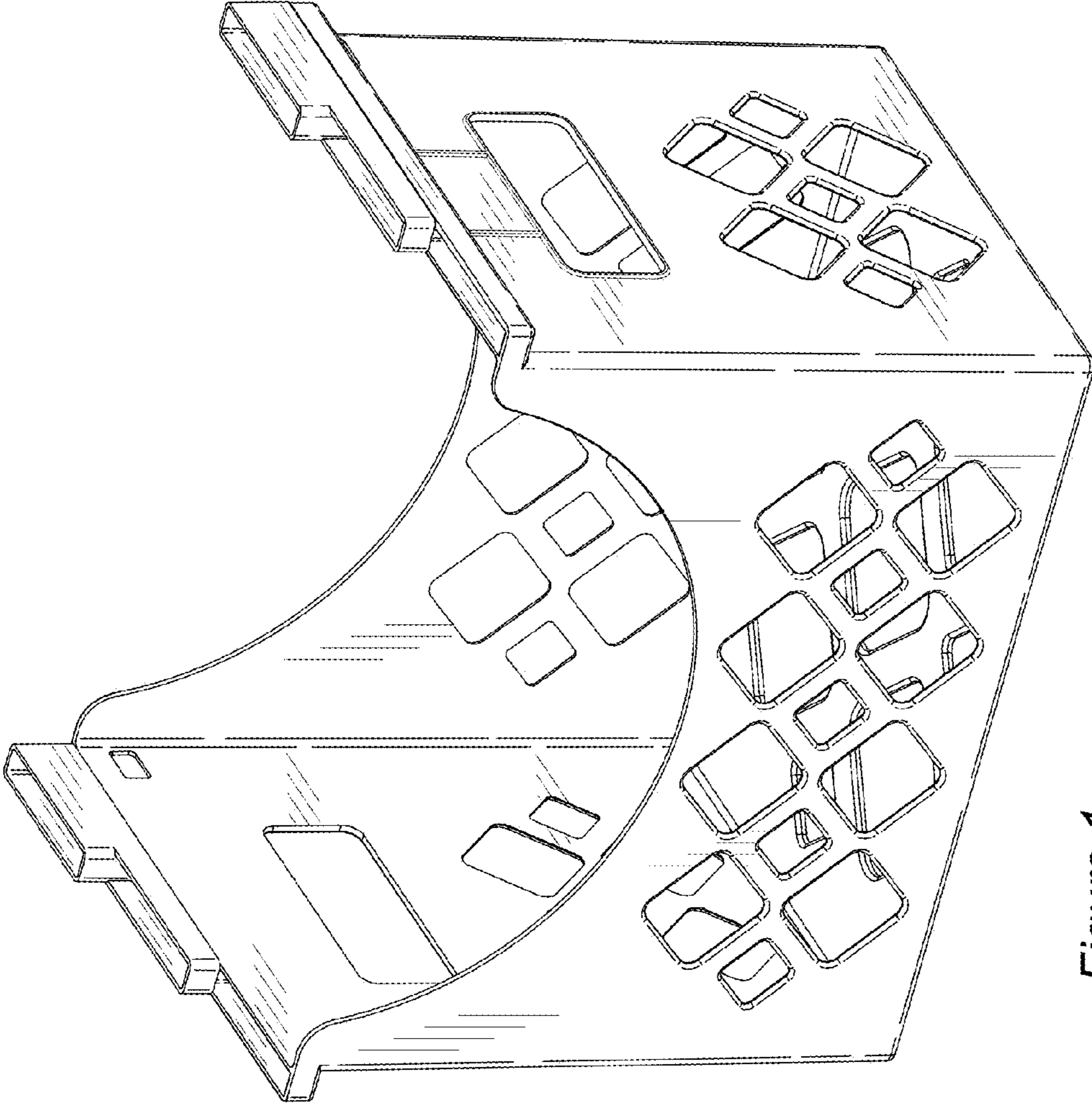

Figure 1

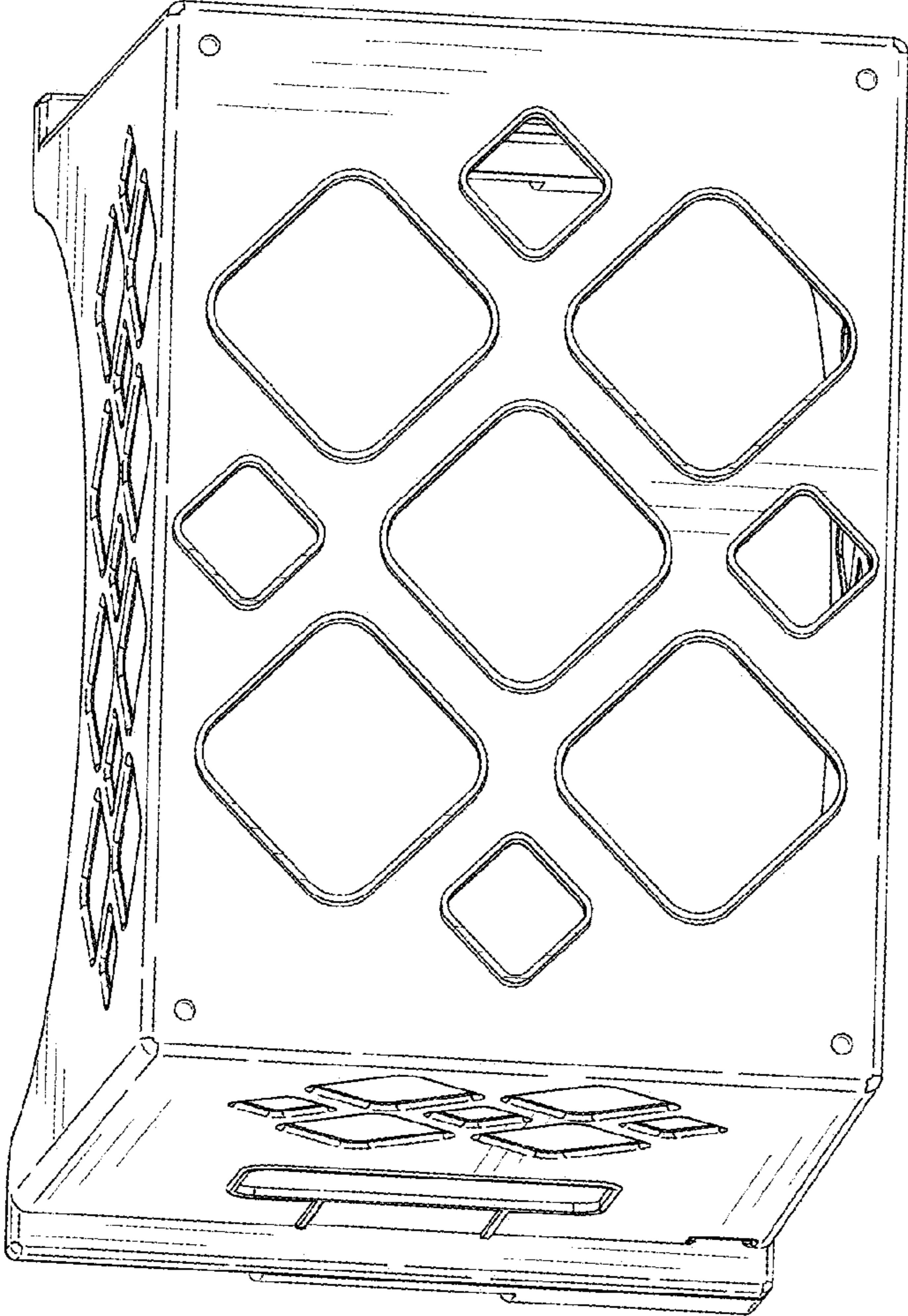

Figure 2

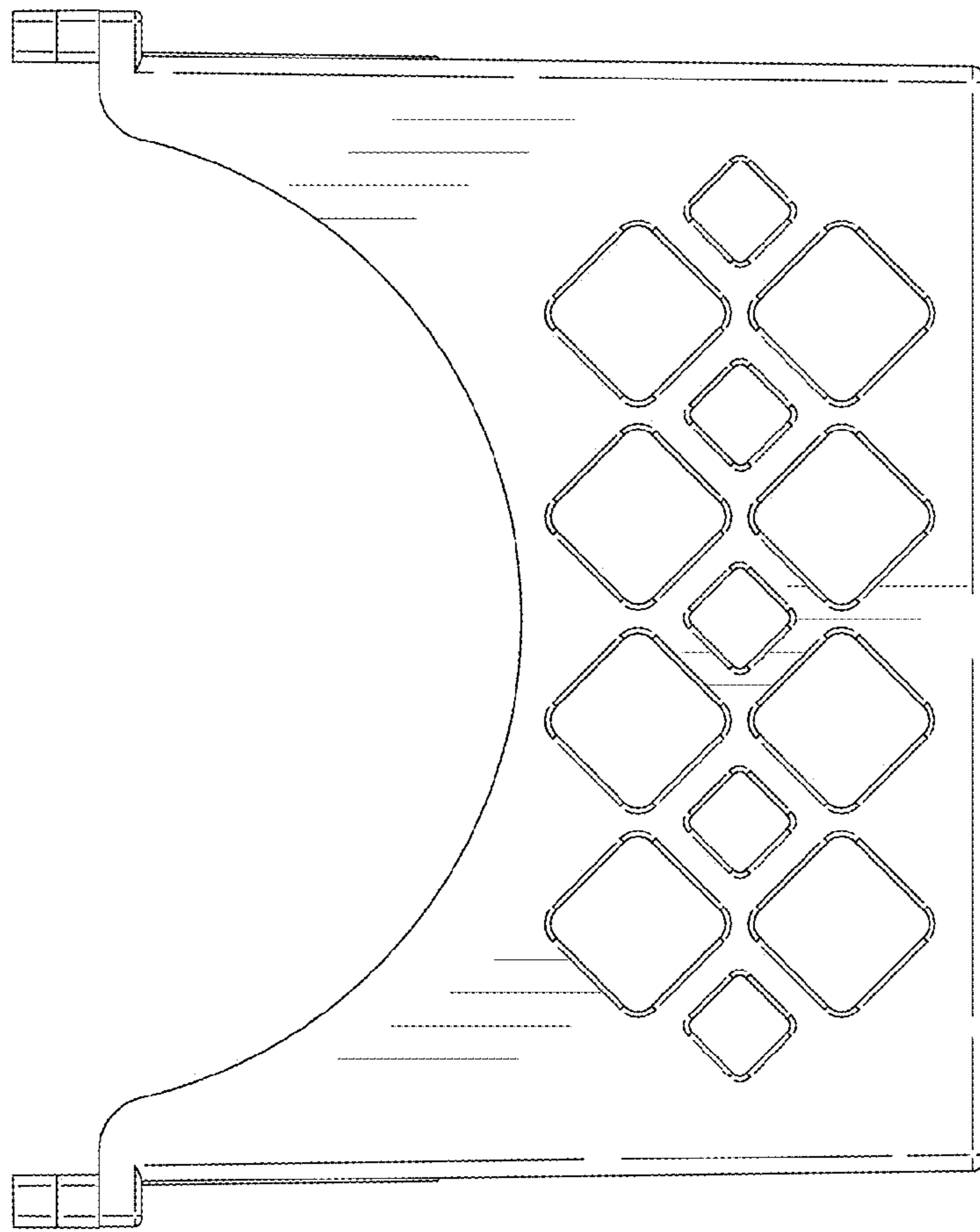

Figure 3

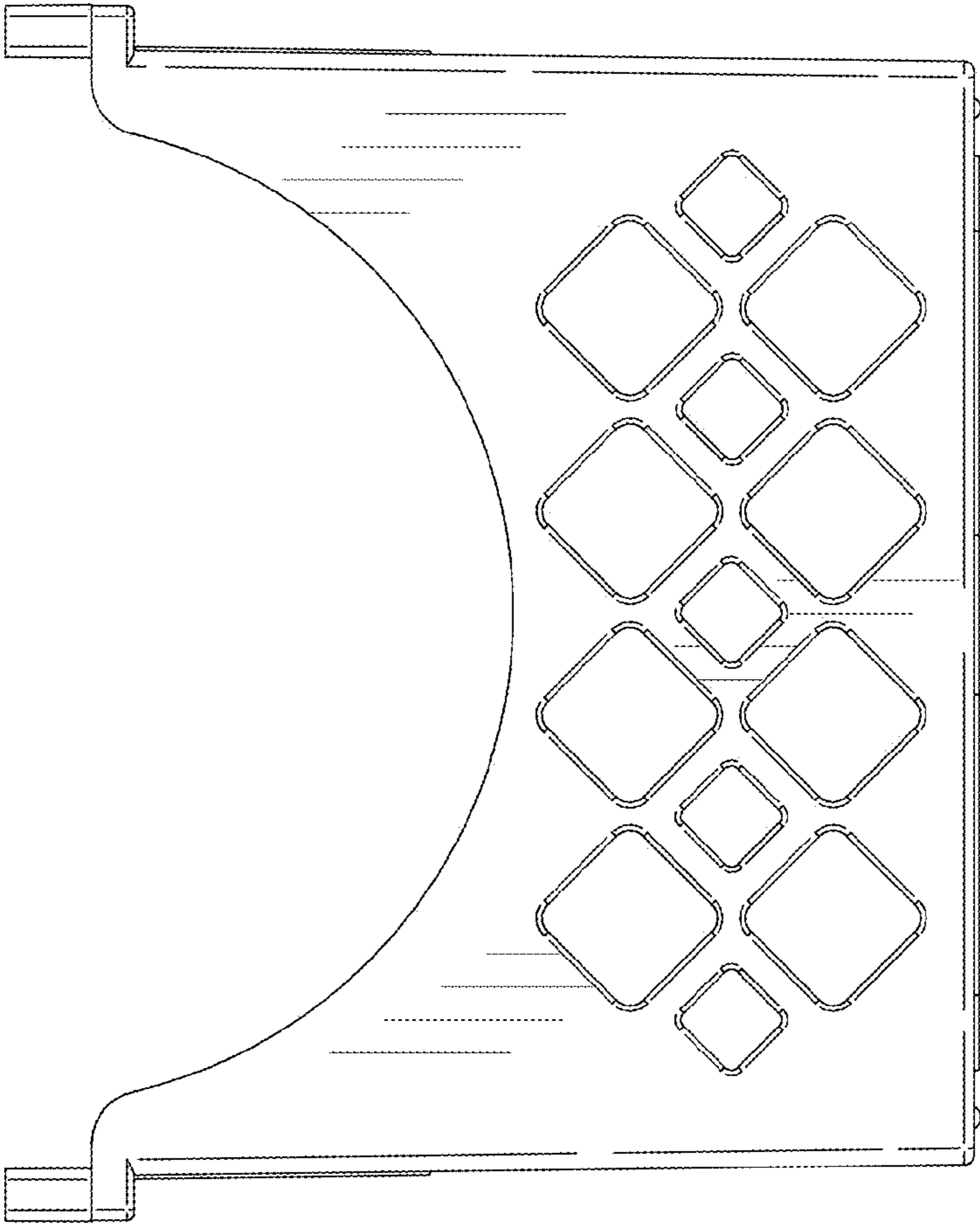

Figure 4

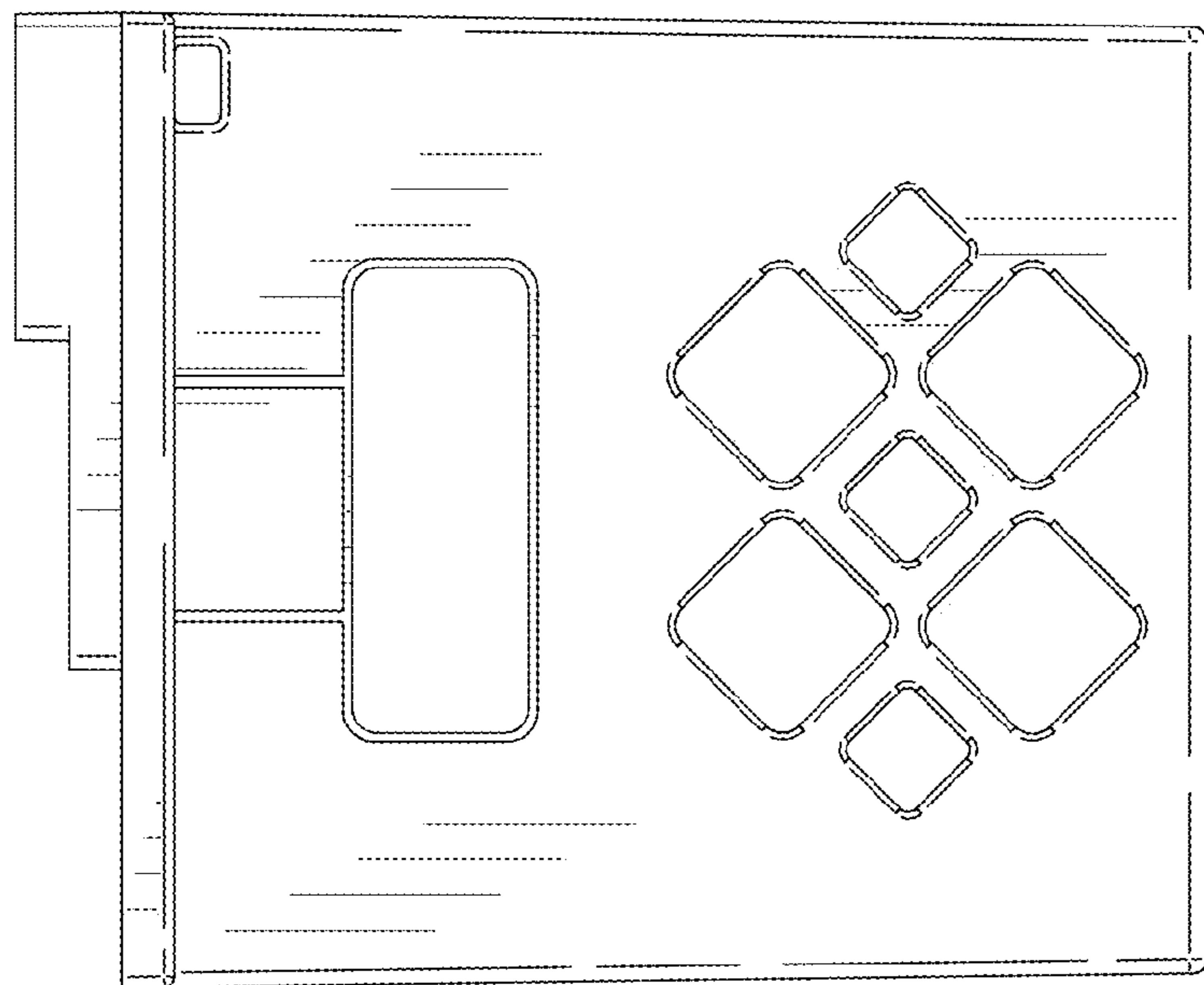

Figure 5

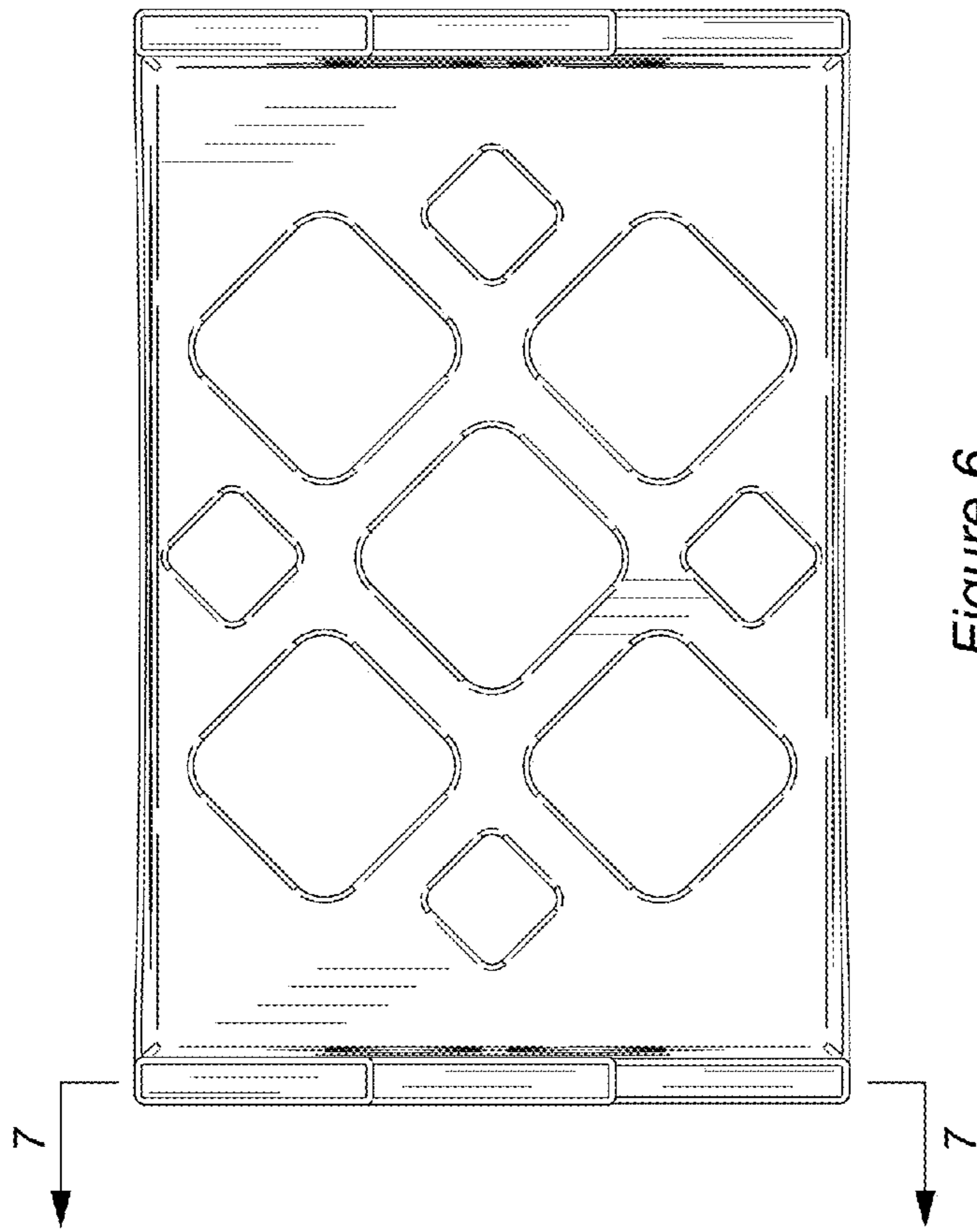

Figure 6

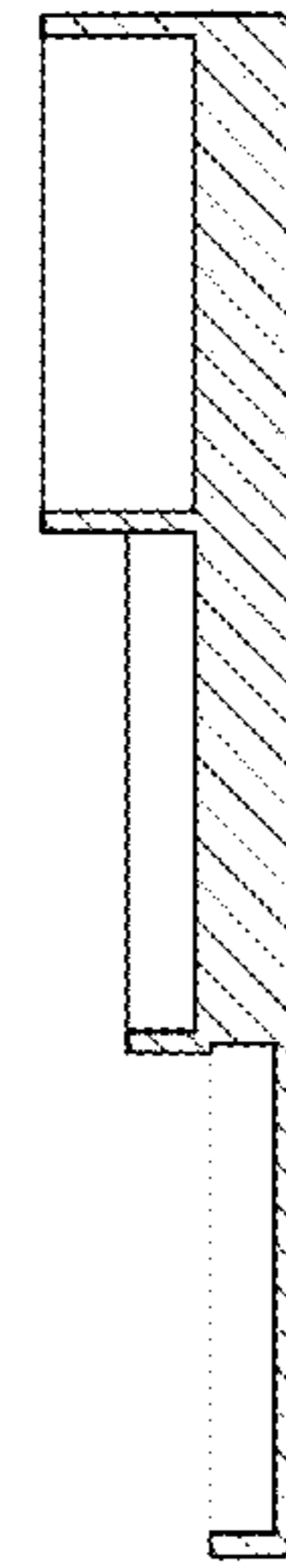

Figure 7

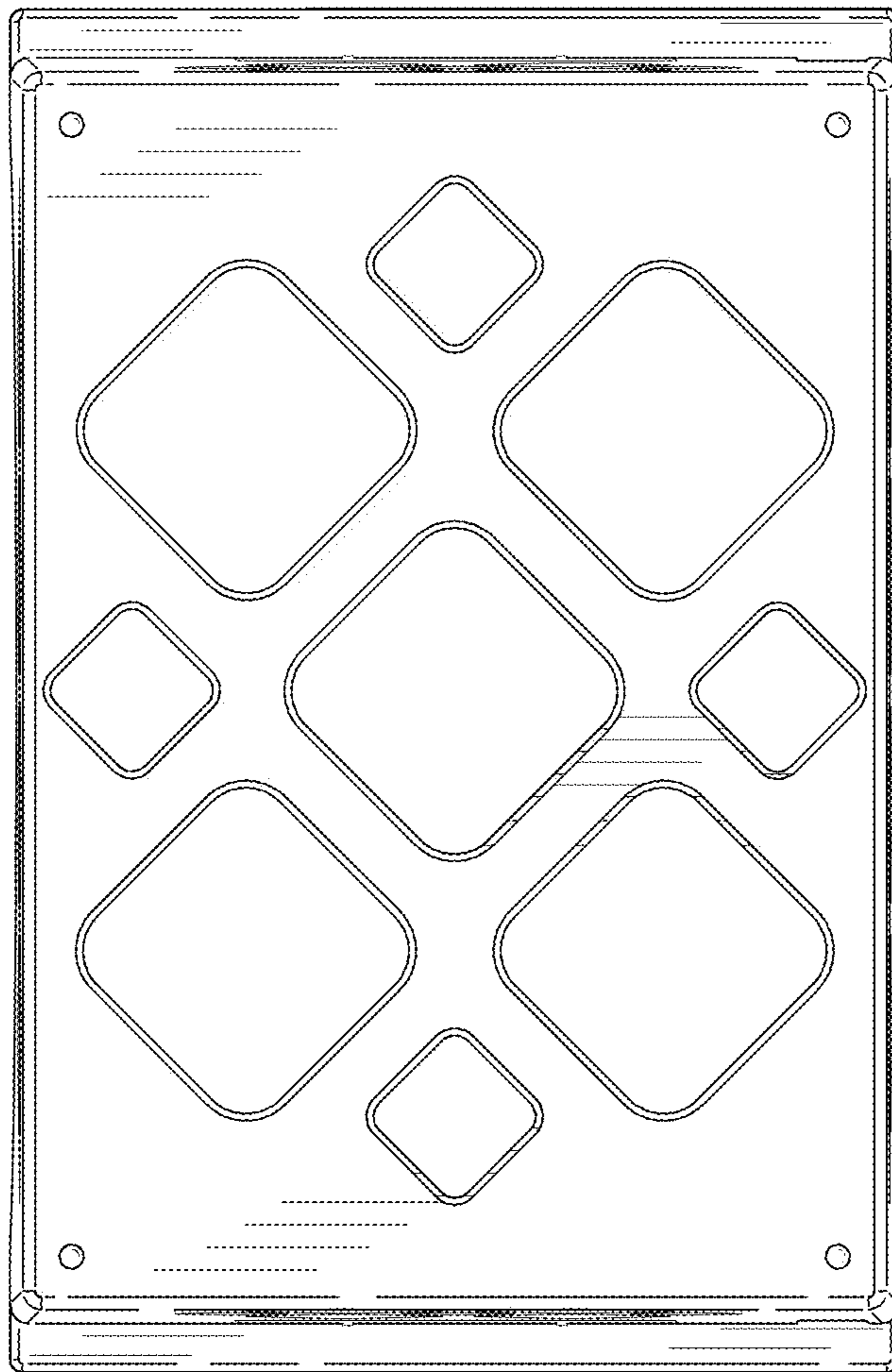

Figure 8