



US00D689484S

(12) **United States Design Patent**
Kuo et al.

(10) **Patent No.:** **US D689,484 S**

(45) **Date of Patent:** **** Sep. 10, 2013**

(54) **ELECTRONIC DEVICE**

(71) Applicant: **Via Technologies, Inc.**, New Taipei (TW)

(72) Inventors: **Neng-An Kuo**, New Taipei (TW);
Ya-Ling Chen, New Taipei (TW)

(73) Assignee: **Via Technologies, Inc.**, New Taipei (TW)

(**) Term: **14 Years**

(21) Appl. No.: **29/432,690**

(22) Filed: **Sep. 19, 2012**

(51) **LOC (9) Cl.** **14-02**

(52) **U.S. Cl.**
USPC **D14/358**

(58) **Field of Classification Search**
USPC 263/300, 308, 348–358, 365, 125;
D13/162, 184, 199; 312/223.1–223.3, 351.11;
360/99.01–99.12; 369/34.01–36.01;
361/679.6, 679.31–679.33
See application file for complete search history.

(56) **References Cited**

U.S. PATENT DOCUMENTS

D471,882 S *	3/2003	Lan	D14/125
6,549,397 B1 *	4/2003	Diaz et al.	361/679.6
6,847,523 B2 *	1/2005	Frame et al.	361/679.33
D514,563 S *	2/2006	Kuramashi et al.	D14/358
D517,065 S *	3/2006	Ko et al.	D14/365
D525,968 S *	8/2006	Peng et al.	D14/300

D603,834 S *	11/2009	Lyman et al.	D14/155
D627,318 S *	11/2010	Petersen et al.	D14/125
D647,090 S *	10/2011	Chen et al.	D14/349
D649,151 S *	11/2011	Ramones et al.	D14/358
D662,904 S *	7/2012	Wu et al.	D14/125

* cited by examiner

Primary Examiner — Freda S Nunn

(74) *Attorney, Agent, or Firm* — McClure, Qualey & Rodack, LLP

(57) **CLAIM**

The ornamental design for electronic device, as shown and described.

DESCRIPTION

FIG. 1 is a front perspective view of a first embodiment of an electronic device;
 FIG. 2 is a front view of the first embodiment thereof;
 FIG. 3 is a rear view of the first embodiment thereof;
 FIG. 4 is a left side of the first embodiment view thereof;
 FIG. 5 is a right side view of the first embodiment thereof;
 FIG. 6 is a top plan view of the first embodiment thereof;
 FIG. 7 is a bottom plan view of the first embodiment thereof;
 FIG. 8 is a front perspective view of a second embodiment thereof;
 FIG. 9 is a front view of the second embodiment thereof;
 FIG. 10 is a rear view of the second embodiment thereof;
 FIG. 11 is a left side of the second embodiment view thereof;
 FIG. 12 is a right side view of the second embodiment thereof;
 FIG. 13 is a top plan view of the second embodiment thereof;
 and,
 FIG. 14 is a bottom plan view of the second embodiment thereof.
 Broken lines shown in FIGS. 8-14 illustrate portions of the electronic device, and form no part of the claimed design.

1 Claim, 14 Drawing Sheets

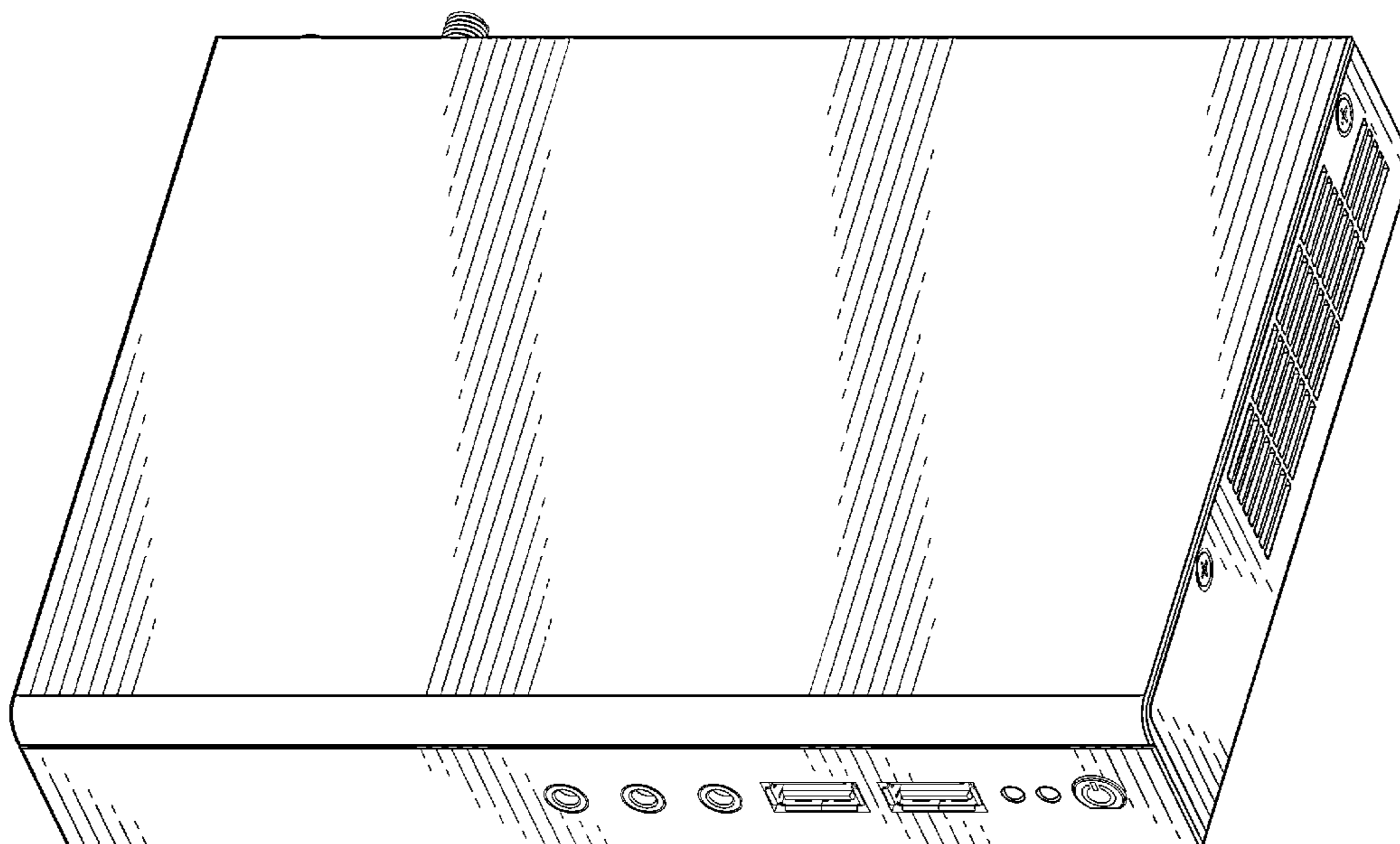

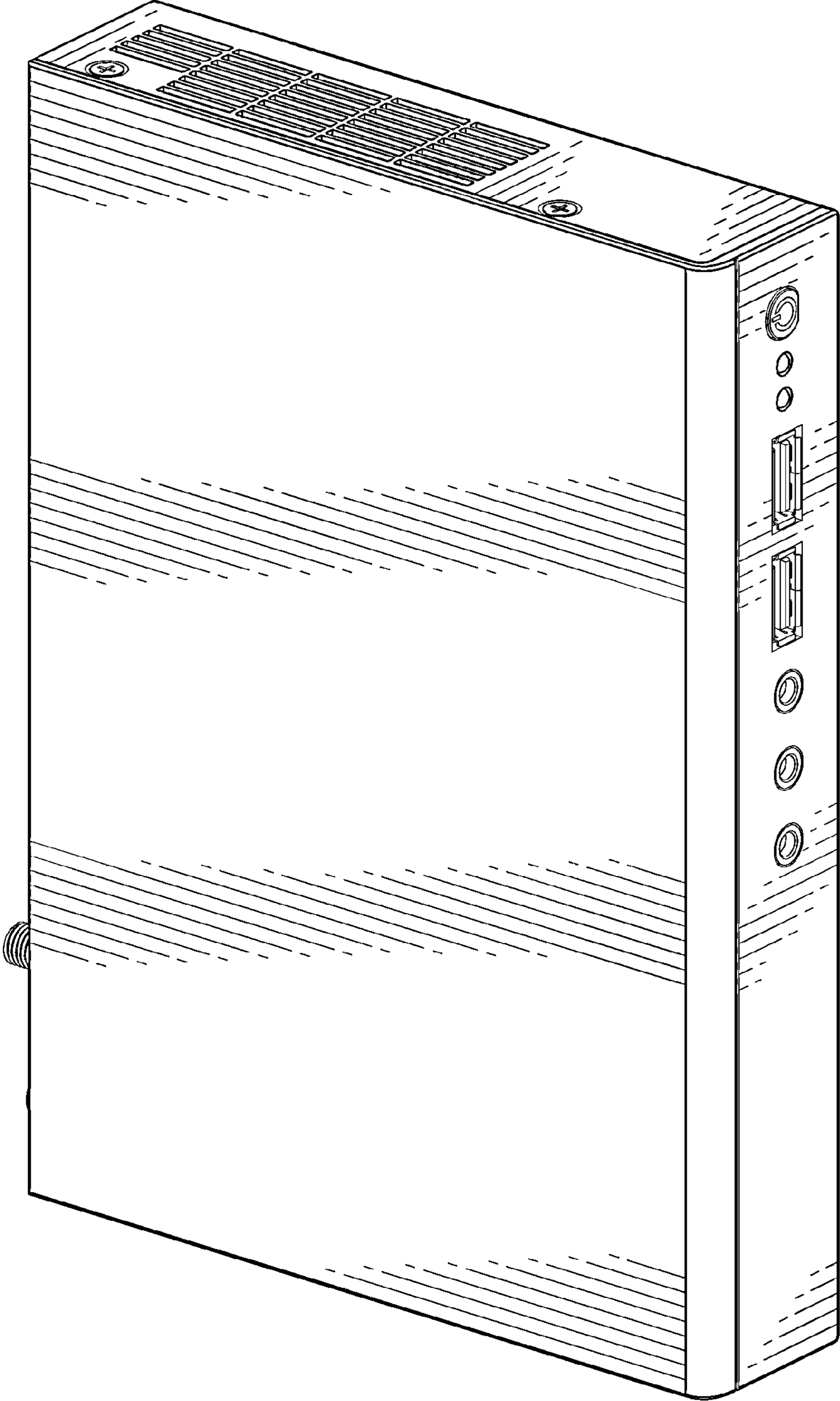

FIG. 1

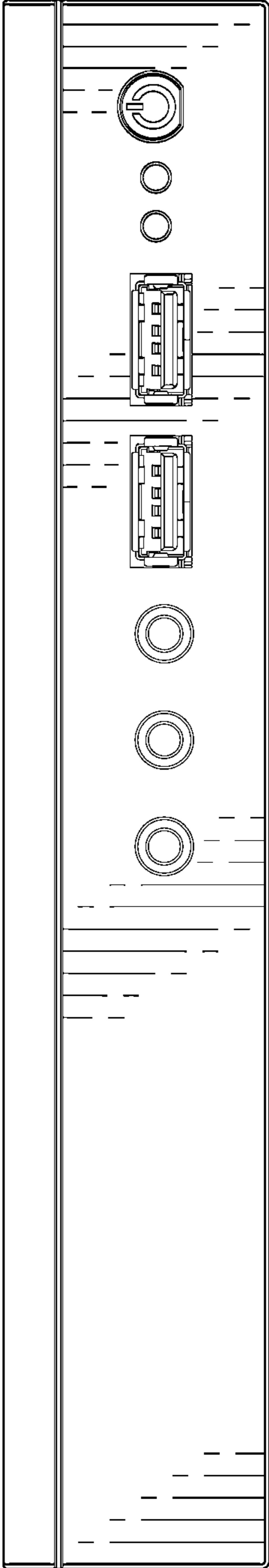

FIG. 2

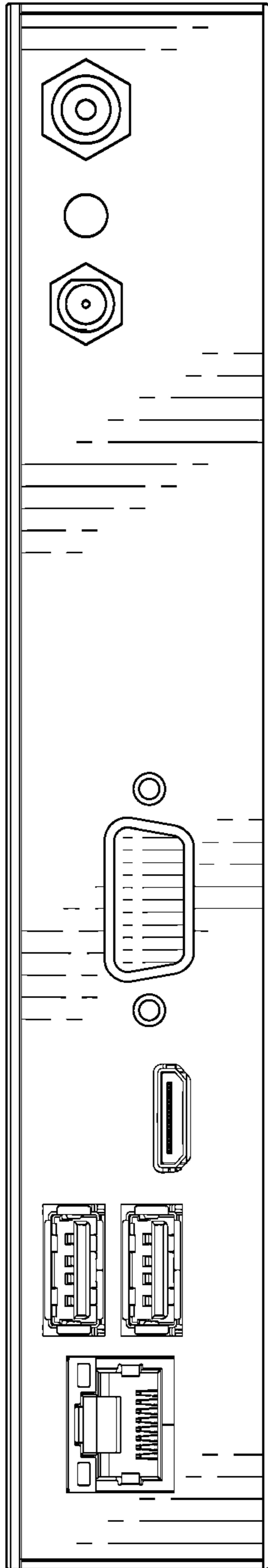

FIG. 3

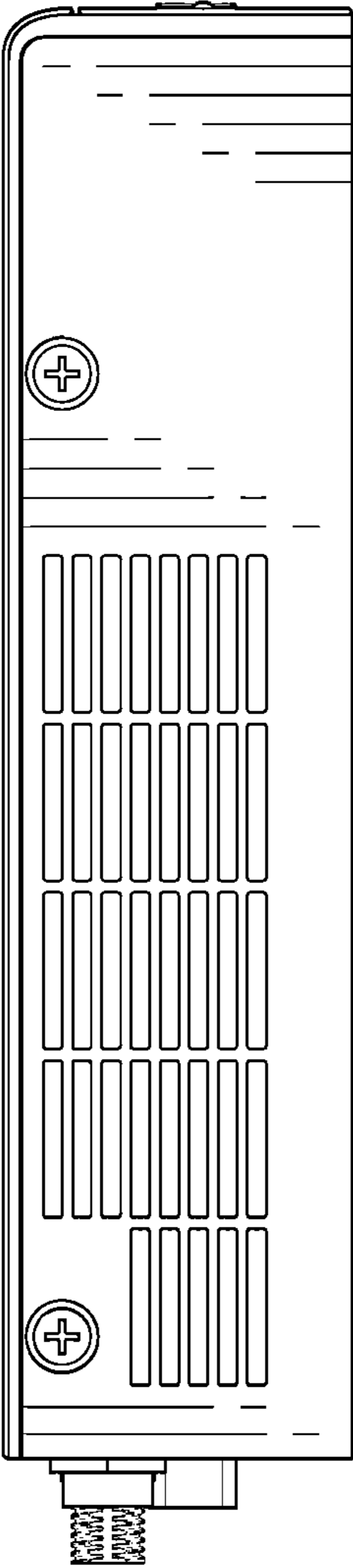

FIG. 4

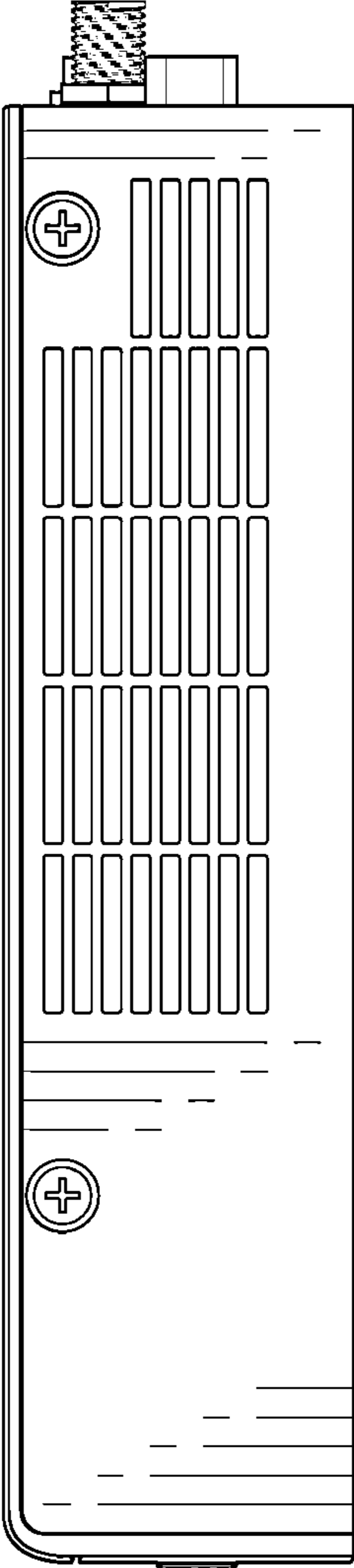

FIG. 5

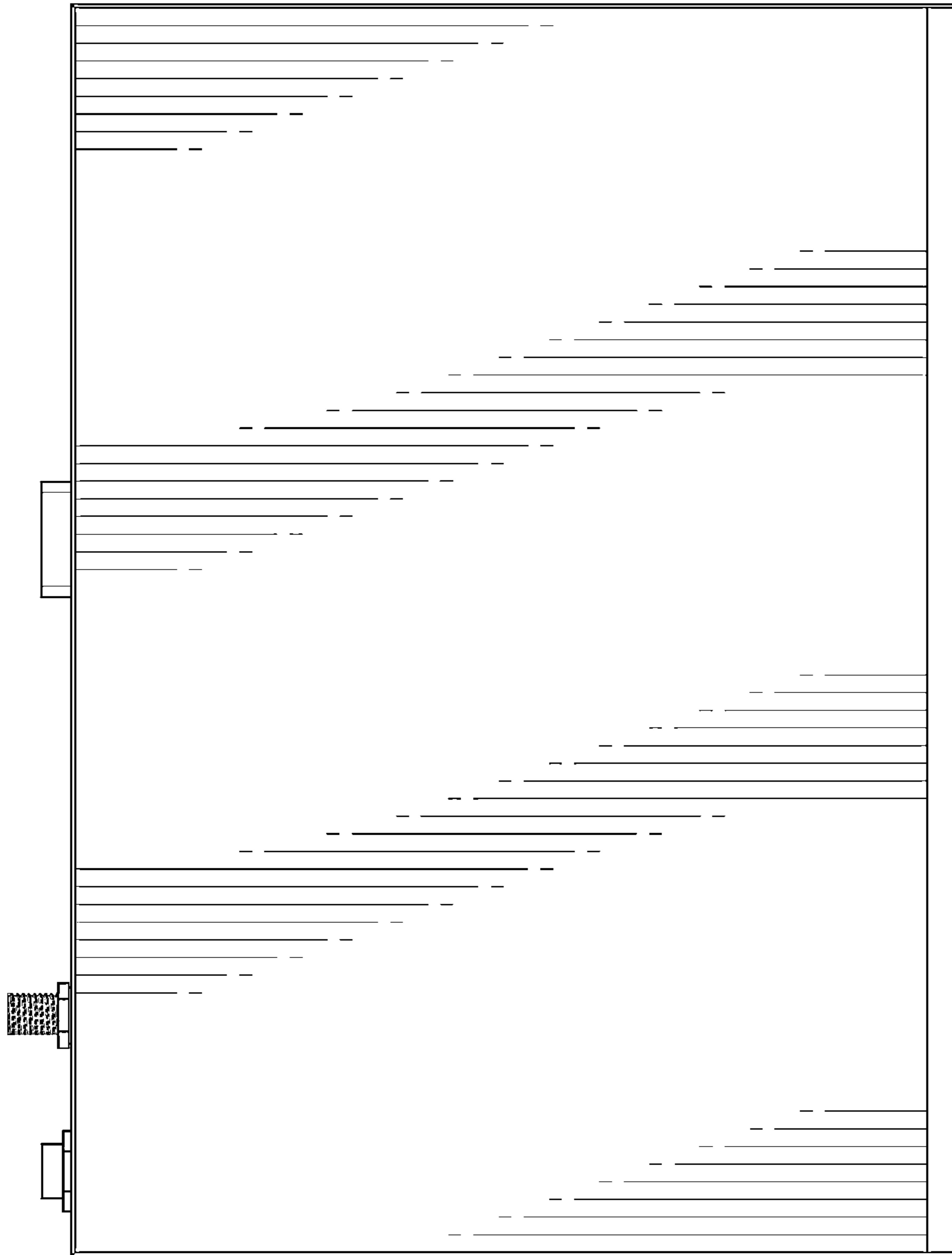

FIG. 6

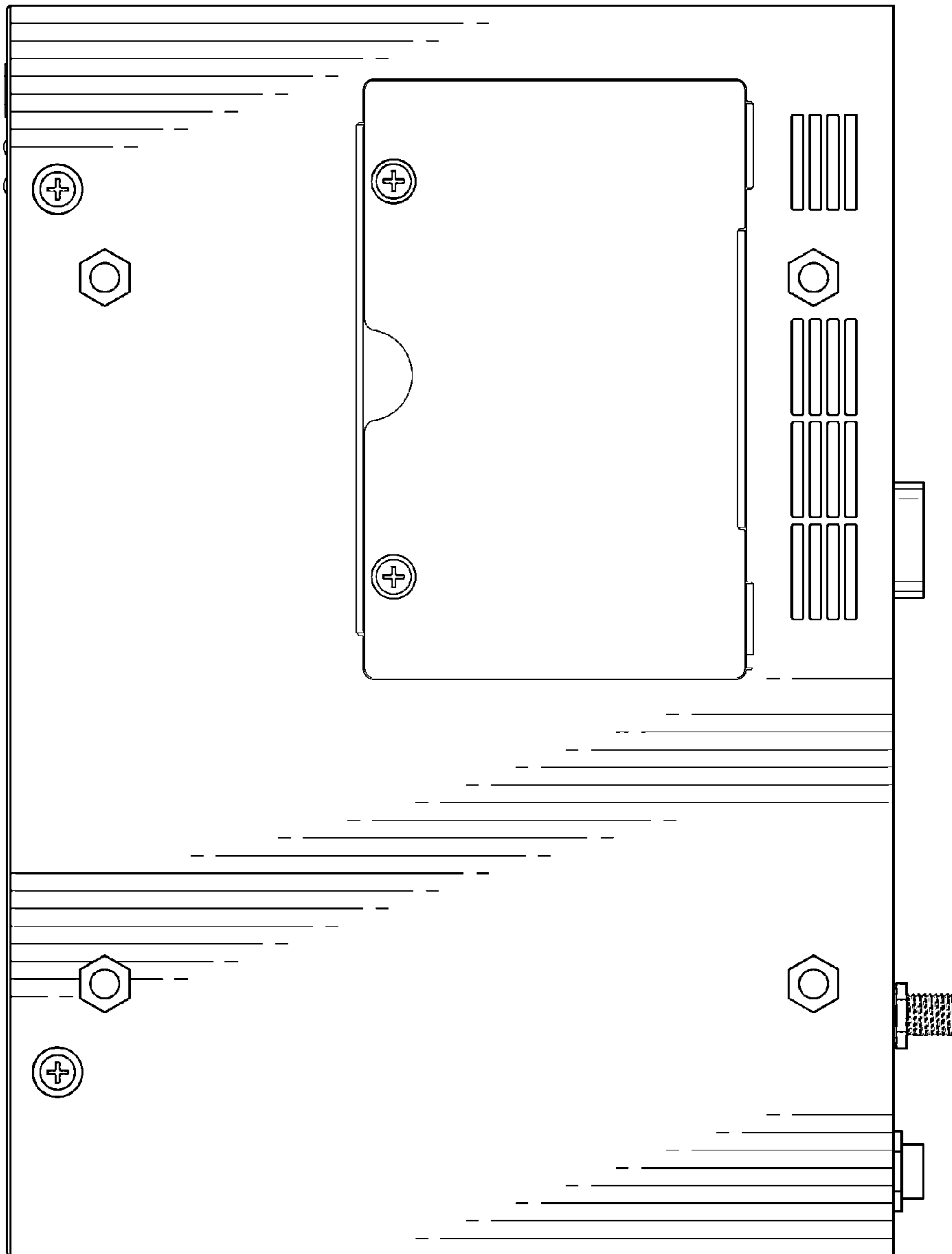

FIG. 7

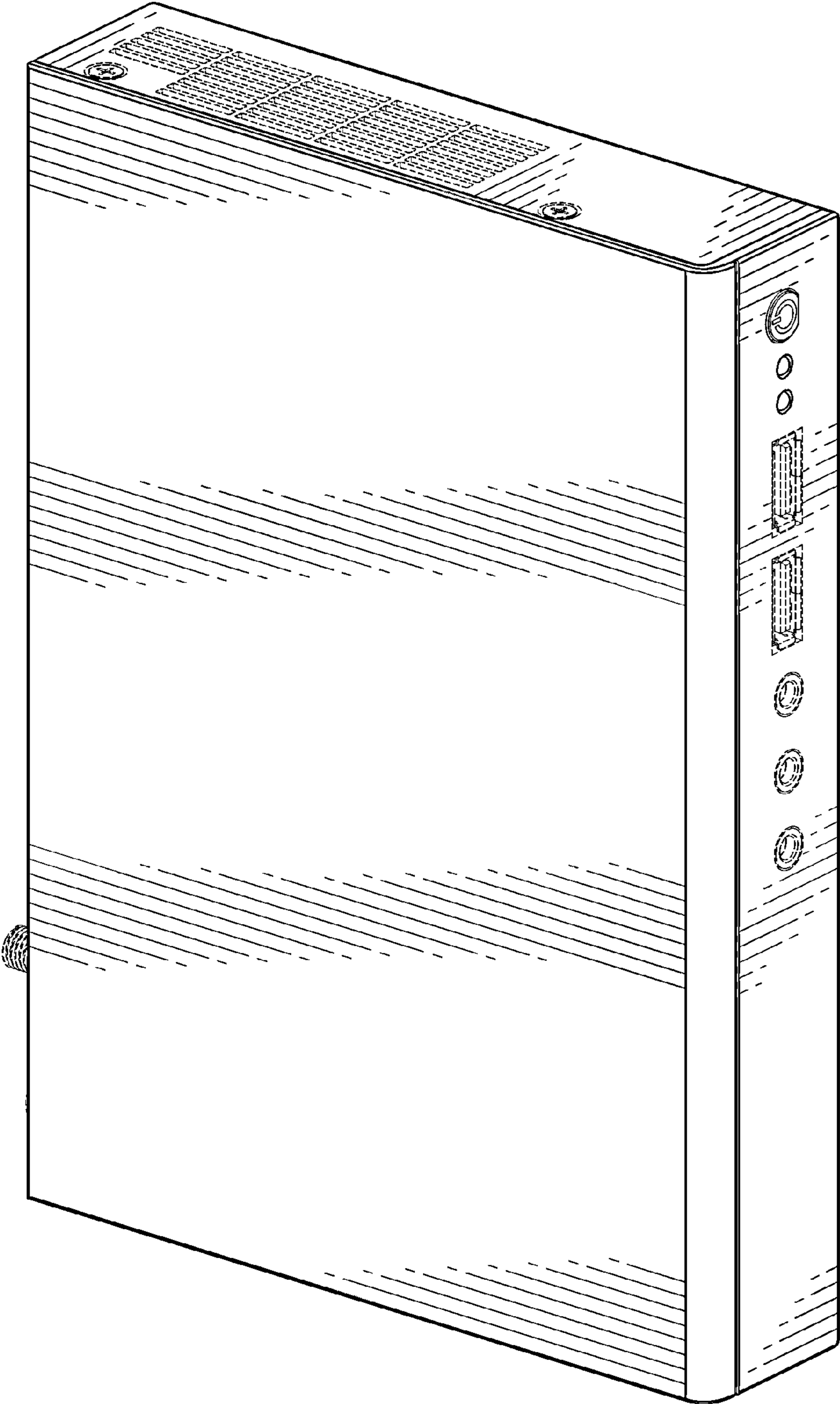

FIG. 8

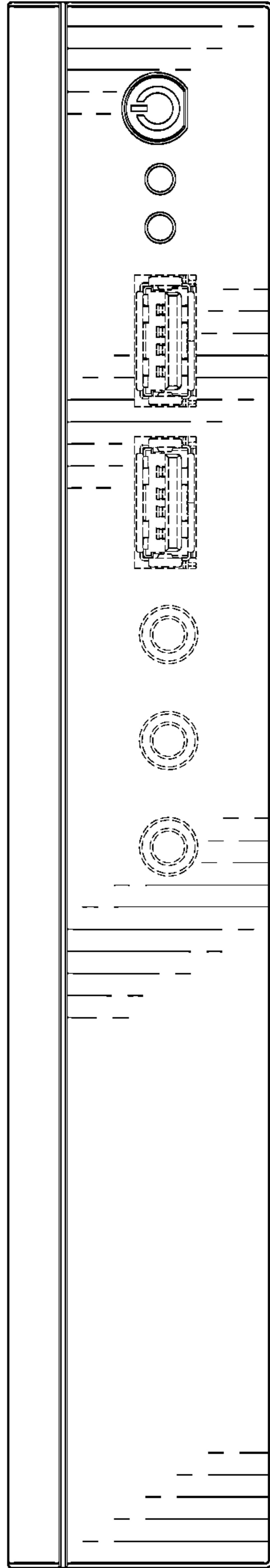

FIG. 9

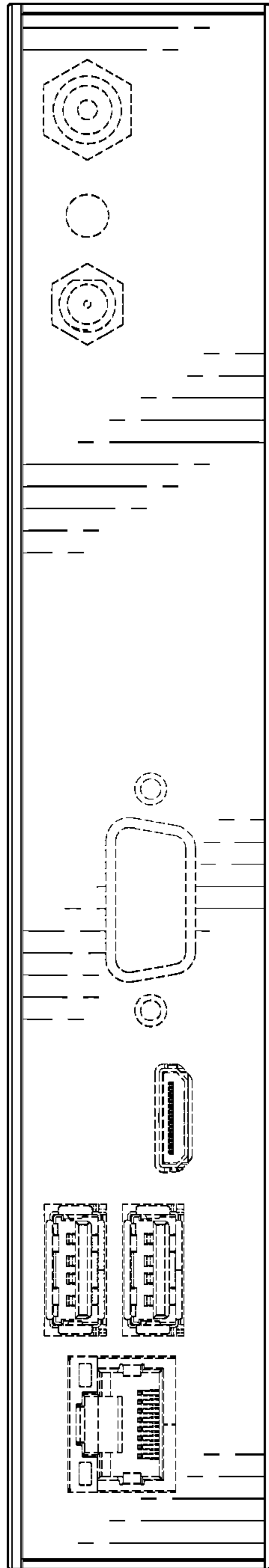

FIG. 10

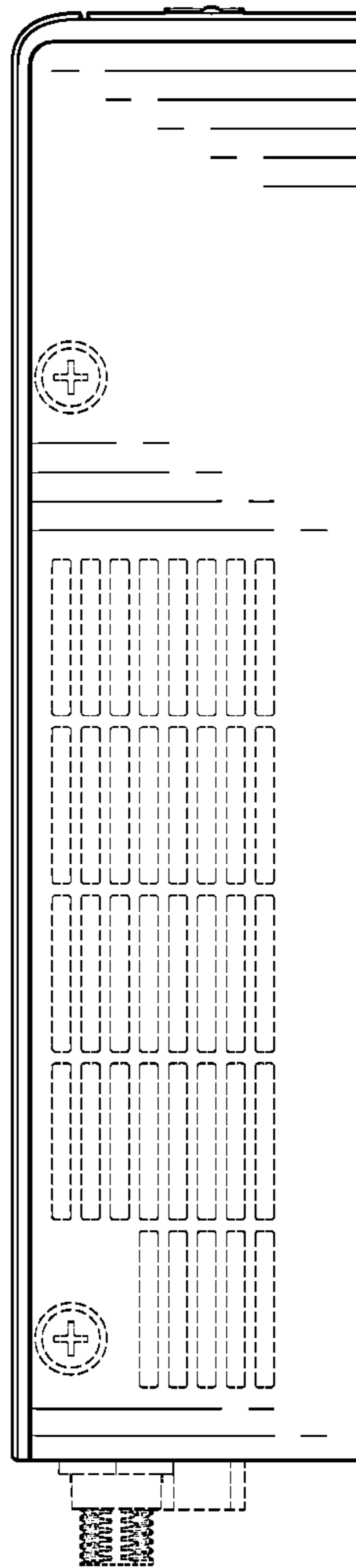

FIG. 11

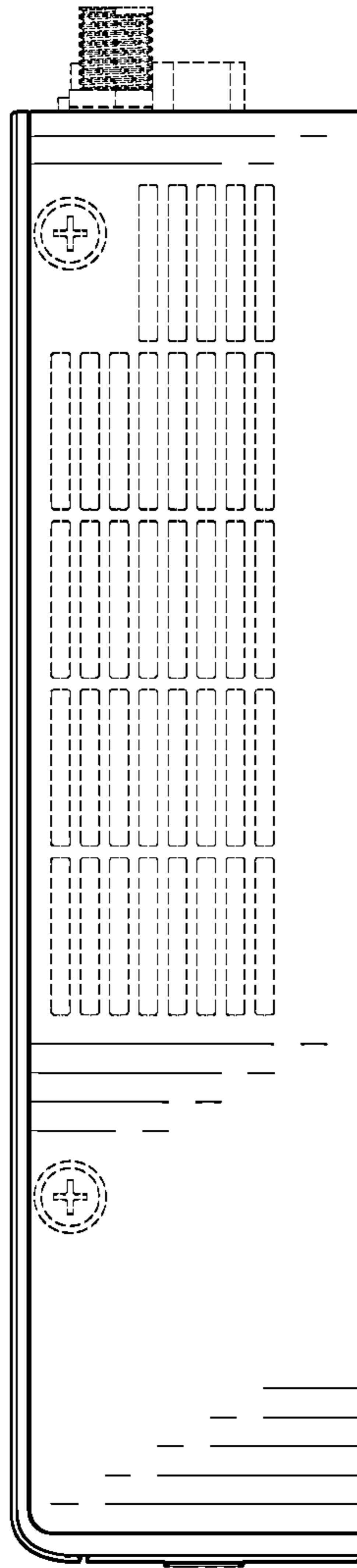

FIG. 12

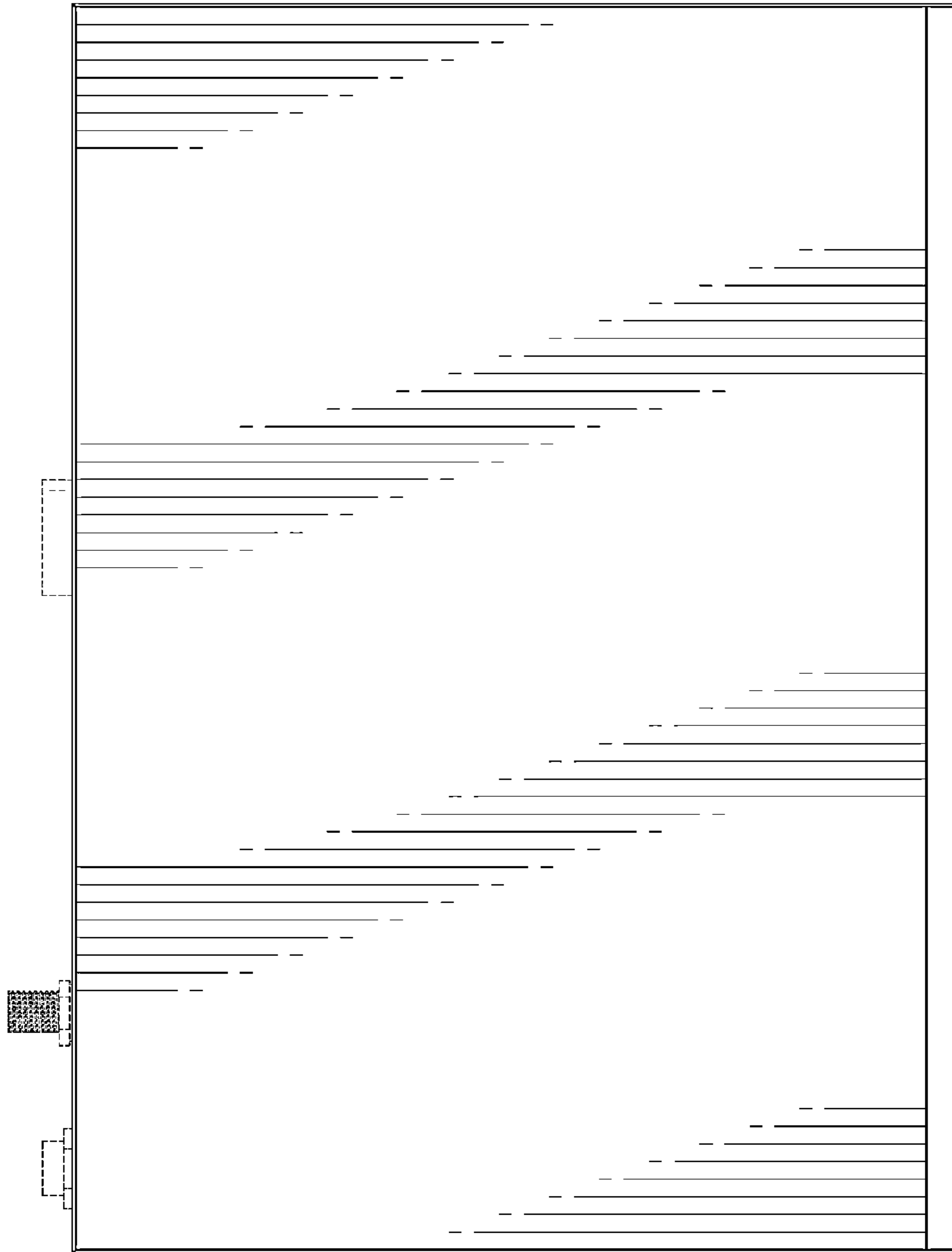

FIG. 13

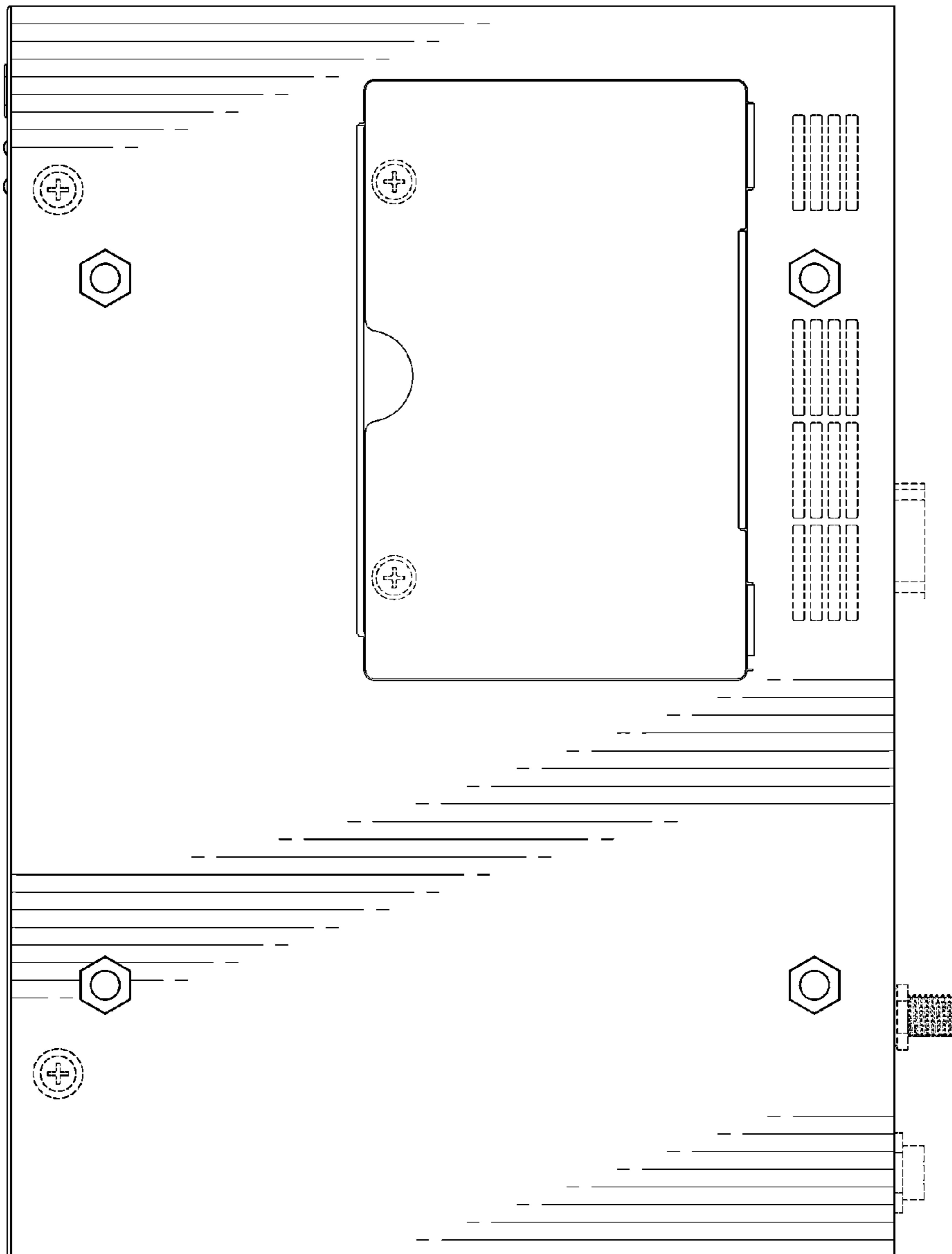

FIG. 14