



US00D689404S

(12) **United States Design Patent**
Katagiri et al.

(10) **Patent No.:** **US D689,404 S**

(45) **Date of Patent:** **** Sep. 10, 2013**

(54) **MOTORCYCLE OR MOTORCYCLE
REPLICA**

(71) Applicant: **Honda Motor Co., Ltd.**, Tokyo (JP)

(72) Inventors: **Kiyoshi Katagiri**, Wako (JP); **Daisuke
Takahashi**, Wako (JP)

(73) Assignee: **Honda Motor Co., Ltd.**, Tokyo (JP)

(**) Term: **14 Years**

(21) Appl. No.: **29/436,740**

(22) Filed: **Nov. 8, 2012**

(30) **Foreign Application Priority Data**

May 10, 2012 (JP) 2012-010803

(51) **LOC (9) Cl.** **12-11**

(52) **U.S. Cl.**
USPC **D12/110**

(58) **Field of Classification Search**
USPC D12/110; 180/219, 220, 225, 229
See application file for complete search history.

(56) **References Cited**

U.S. PATENT DOCUMENTS

D596,082 S * 7/2009 Ueno et al. D12/110
D636,708 S * 4/2011 Katagiri et al. D12/110
D649,913 S * 12/2011 Tsukui et al. D12/110

D649,915 S * 12/2011 Aiello et al. D12/110
D652,769 S * 1/2012 Kudo et al. D12/110
D677,601 S * 3/2013 Yanagita et al. D12/110
2010/0089679 A1* 4/2010 Inomori et al. 180/219
2010/0089680 A1* 4/2010 Inomori et al. 180/219

* cited by examiner

Primary Examiner — Susan M Lee

Assistant Examiner — Linda G Brooks

(74) *Attorney, Agent, or Firm* — Westerman, Hattori,
Daniels & Adrian, LLP

(57) **CLAIM**

The ornamental design for a motorcycle or motorcycle replica, as shown and described.

DESCRIPTION

FIG. 1 is a perspective view from the right side of a motorcycle or motorcycle replica.

FIG. 2 is a perspective view from the left side thereof.

FIG. 3 is a perspective view from the right side thereof.

FIG. 4 is a perspective view from the left side thereof.

FIG. 5 is a front elevation view thereof.

FIG. 6 is a rear elevation view thereof.

FIG. 7 is a right side elevation view thereof.

FIG. 8 is a left side elevation view thereof.

FIG. 9 is a top plan view thereof; and,

FIG. 10 is a bottom plan view thereof.

The portions of the motorcycle shown in broken lines are for the purpose of showing environmental structure only and form no part of the claimed design.

1 Claim, 10 Drawing Sheets

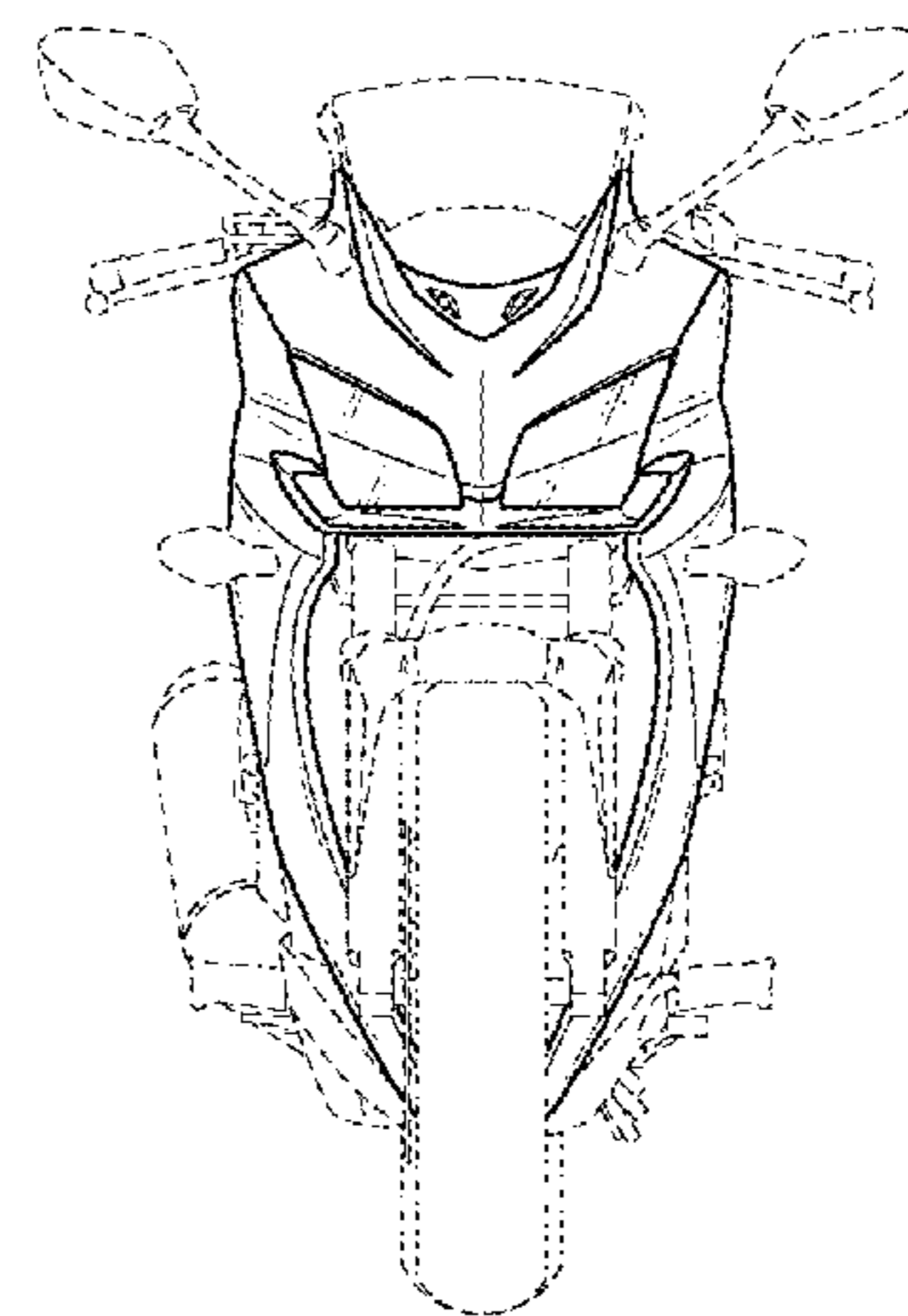
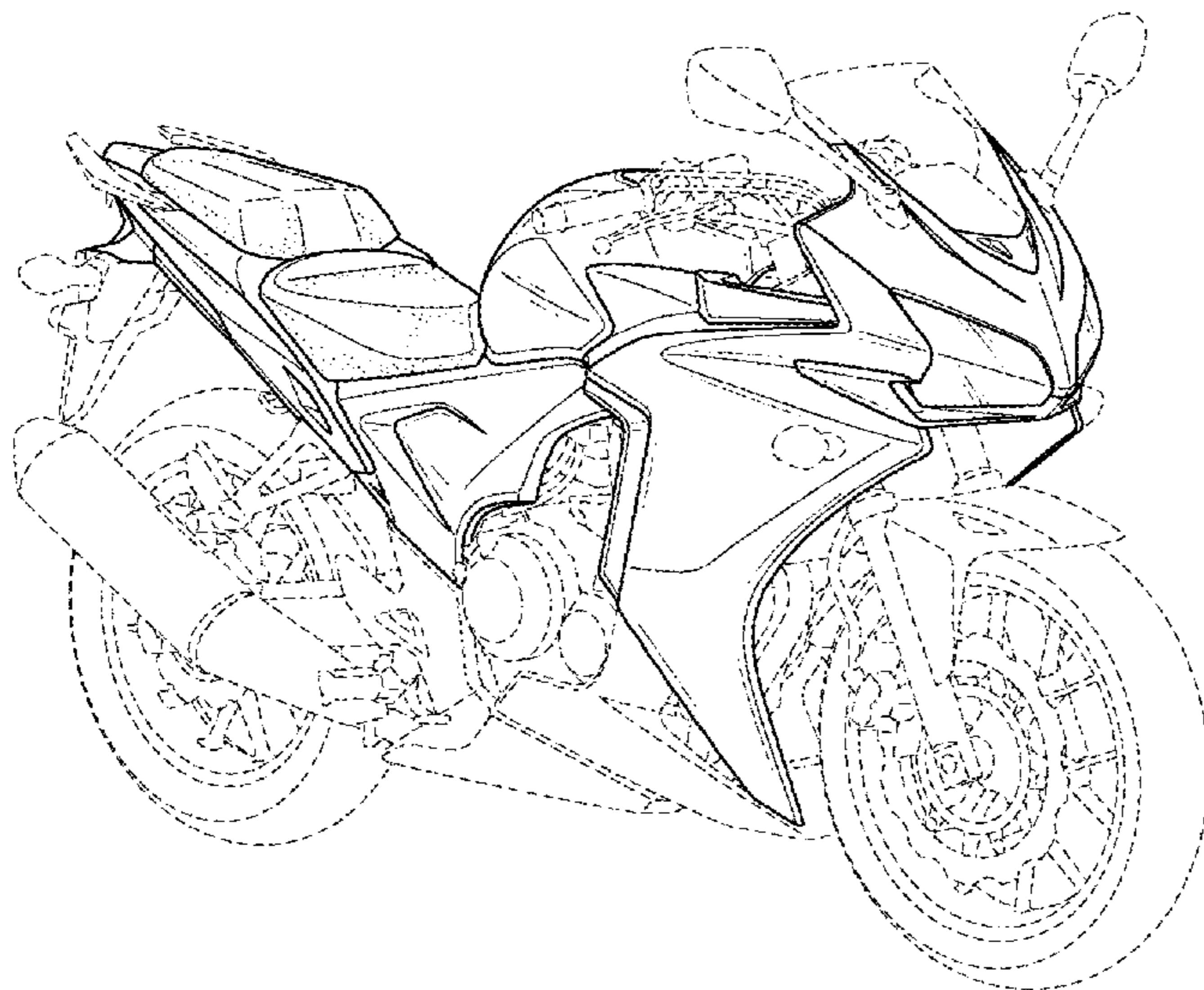

FIG. 1

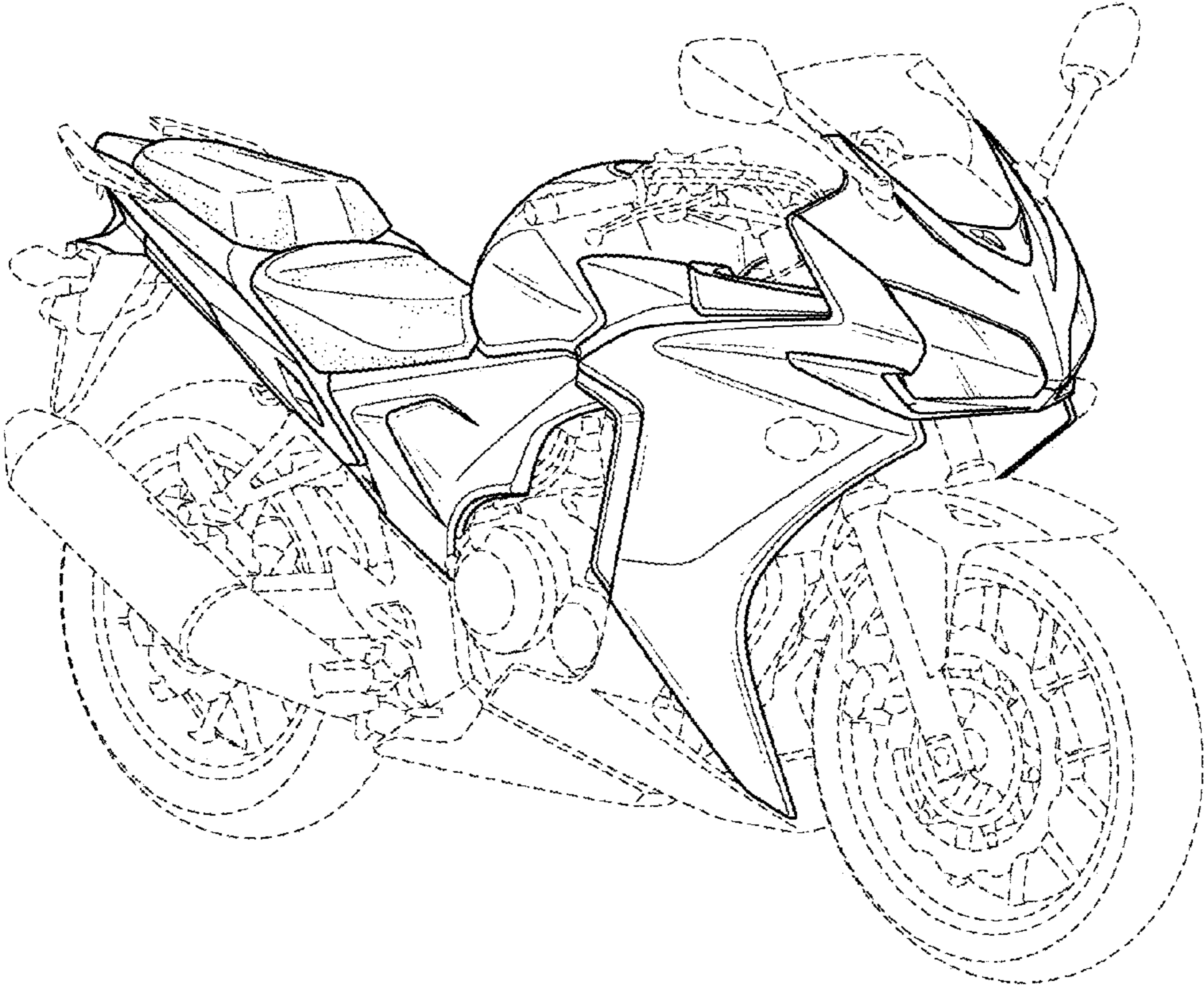

FIG. 2

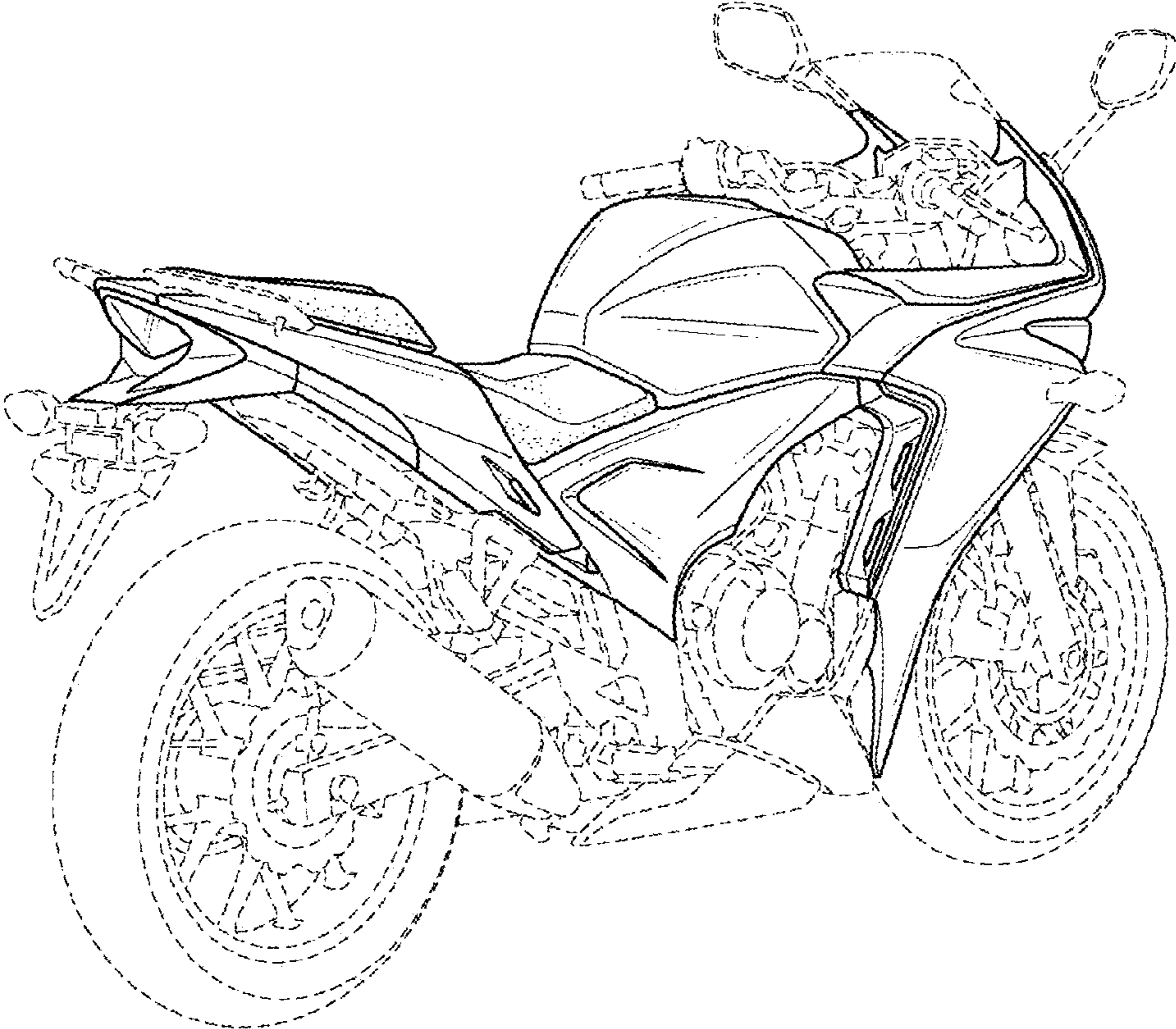

FIG. 3

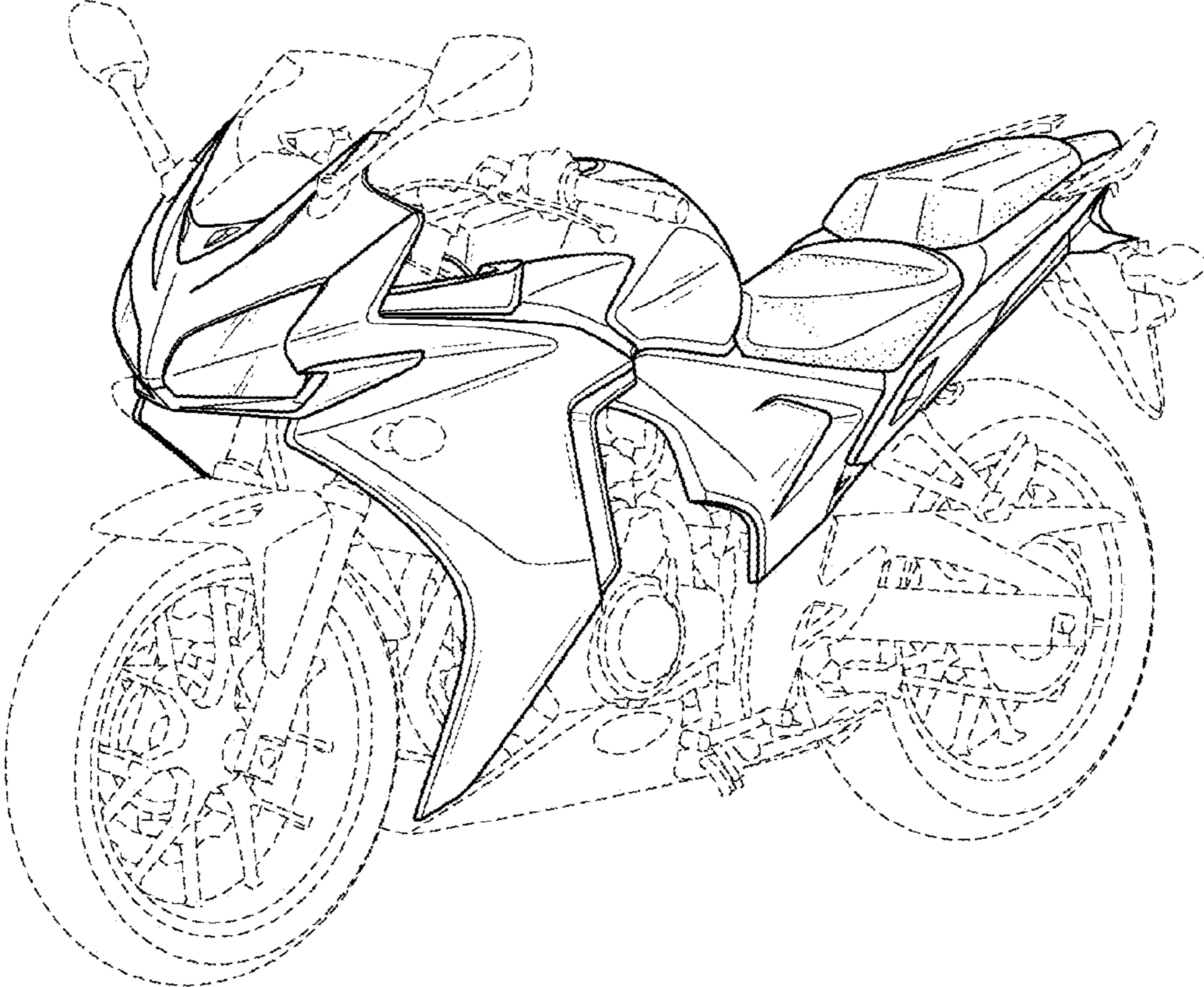

FIG. 4

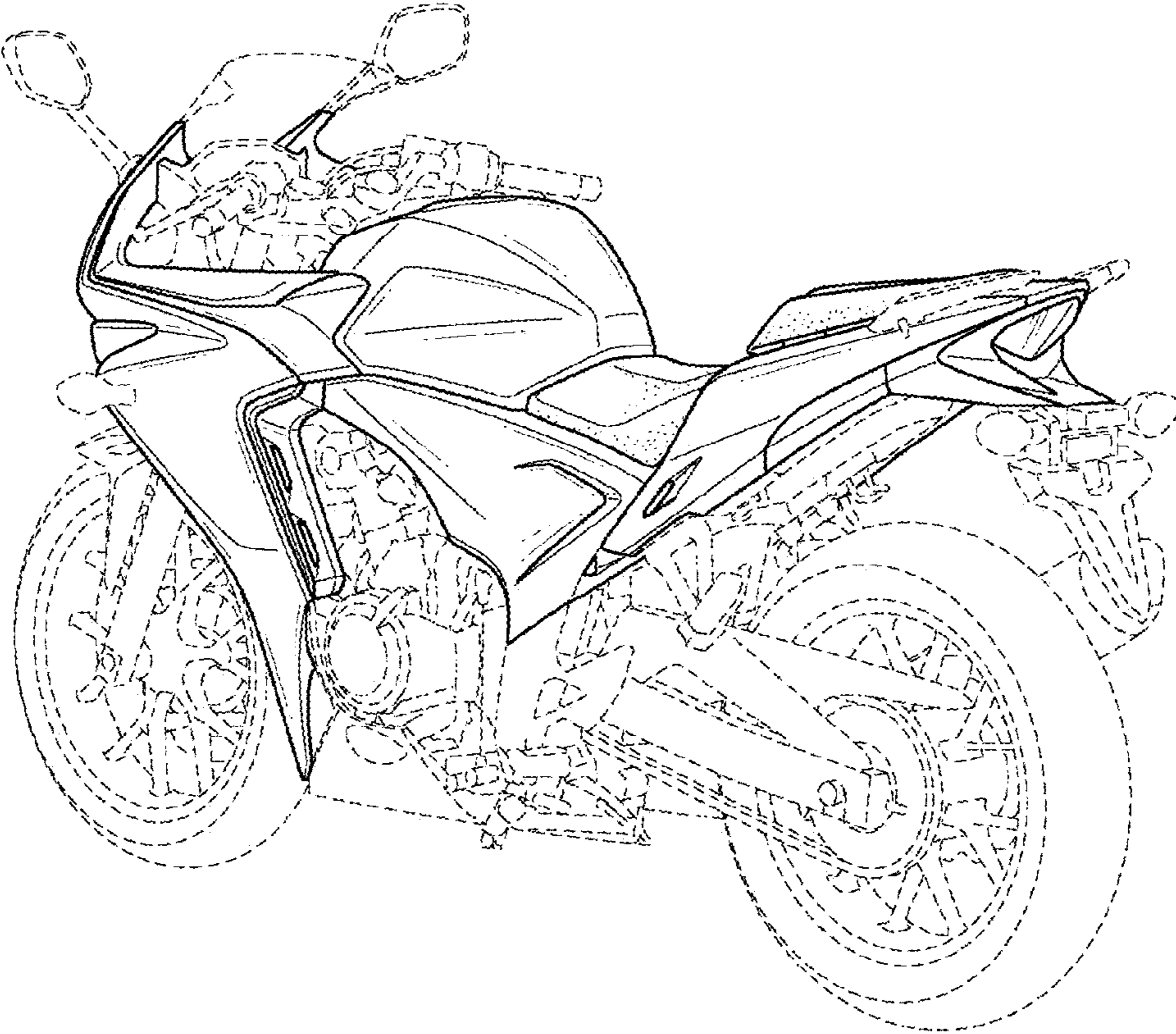

FIG. 5

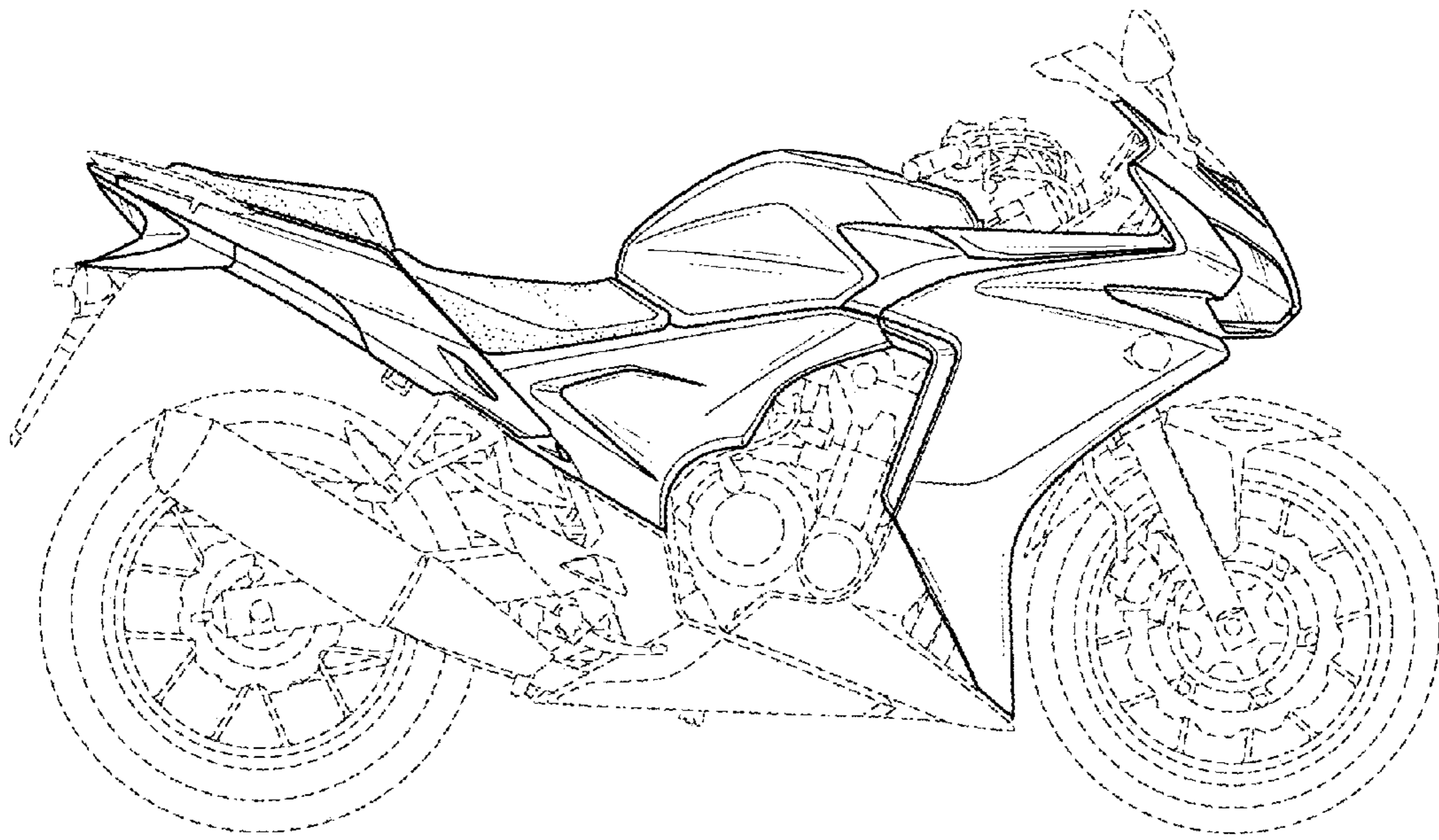

FIG. 6

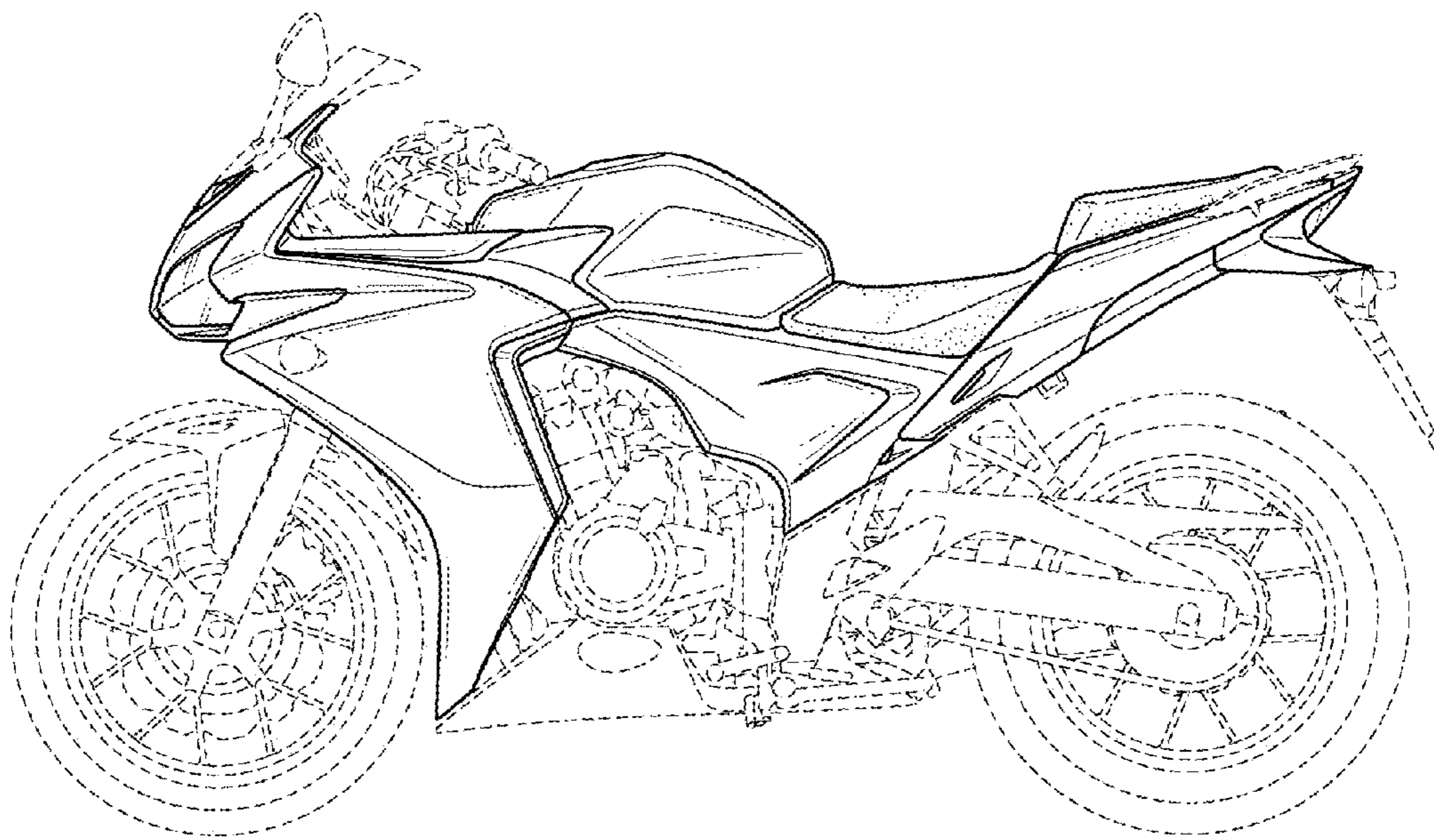

FIG. 7

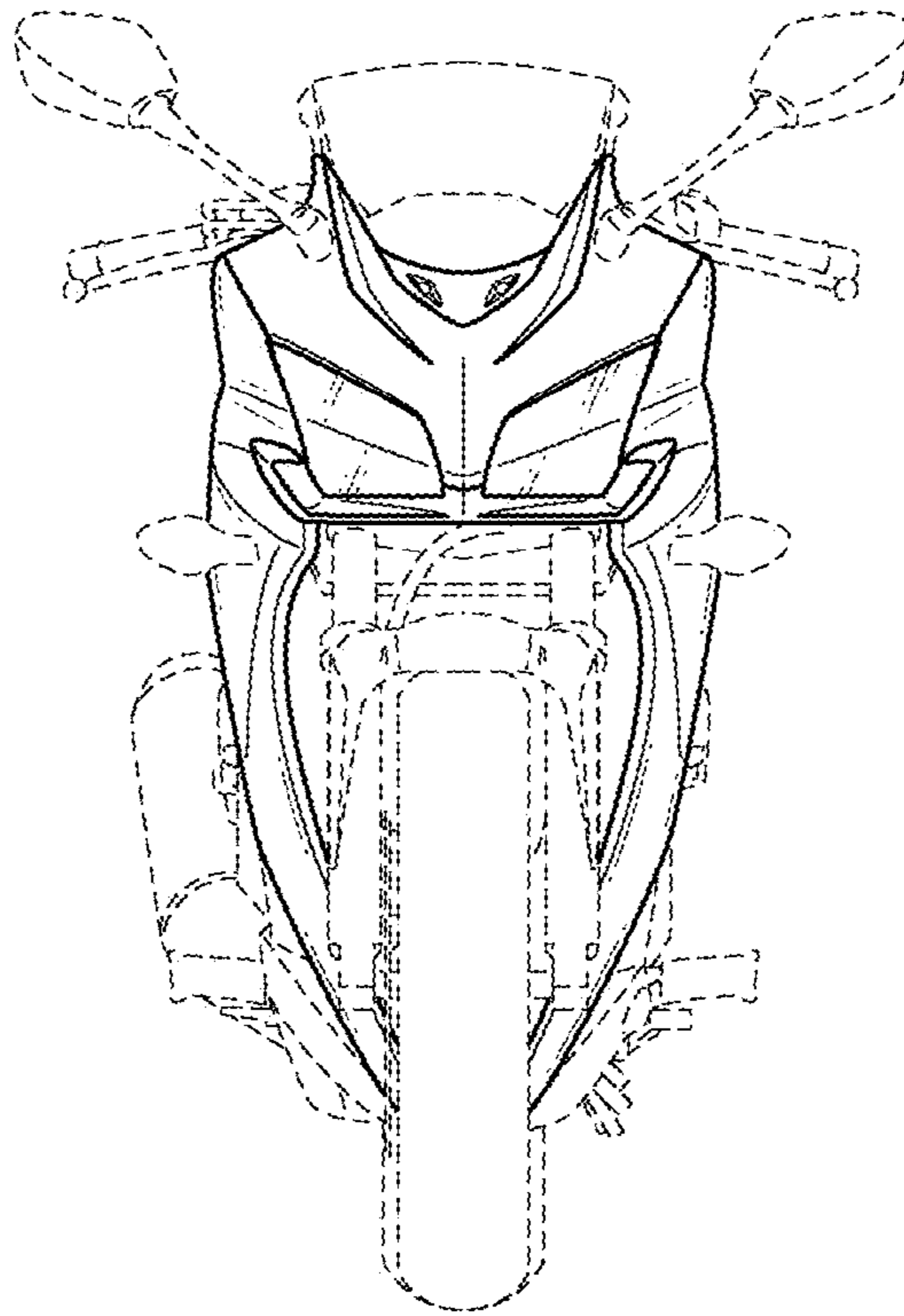

FIG. 8

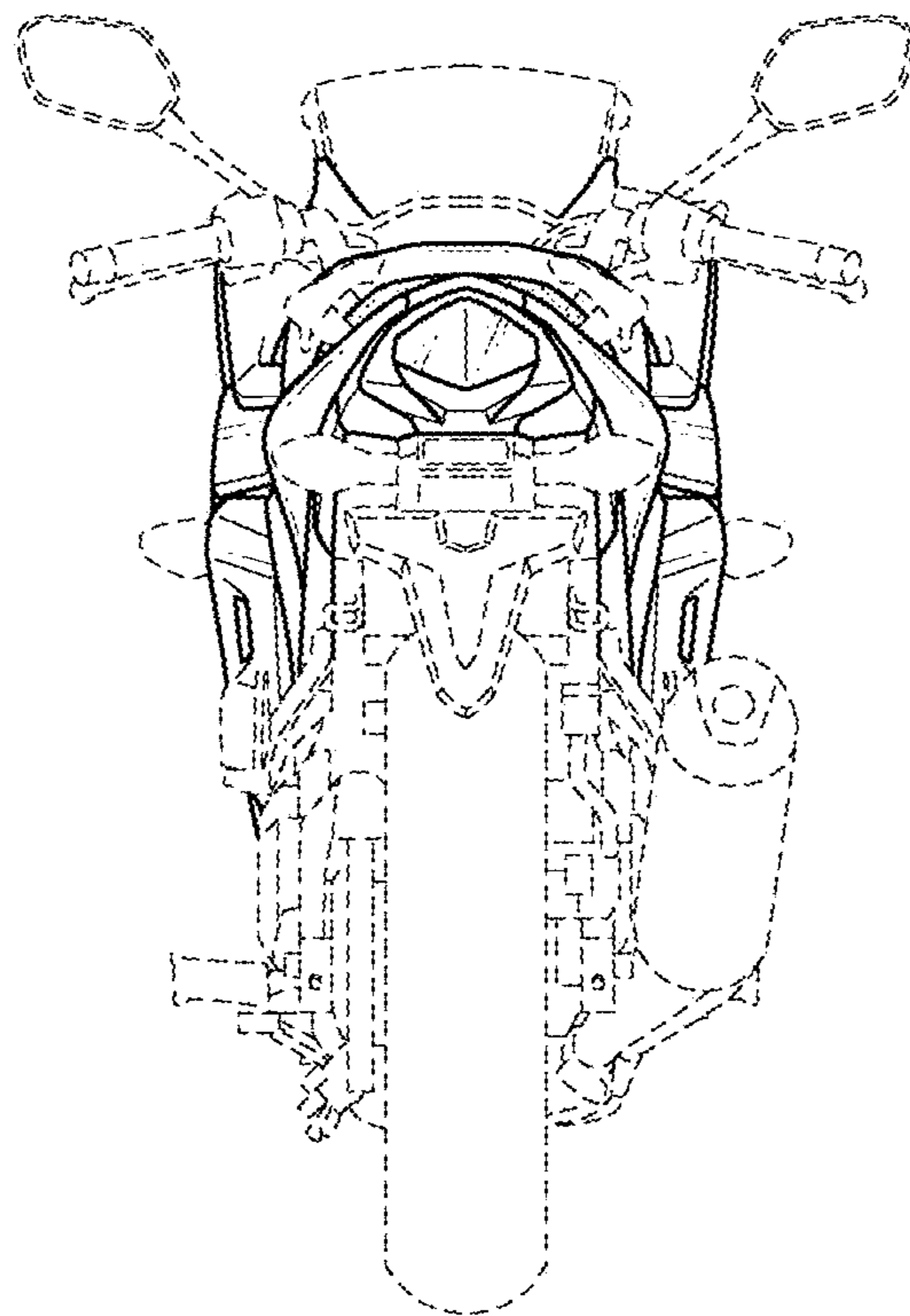

FIG. 9

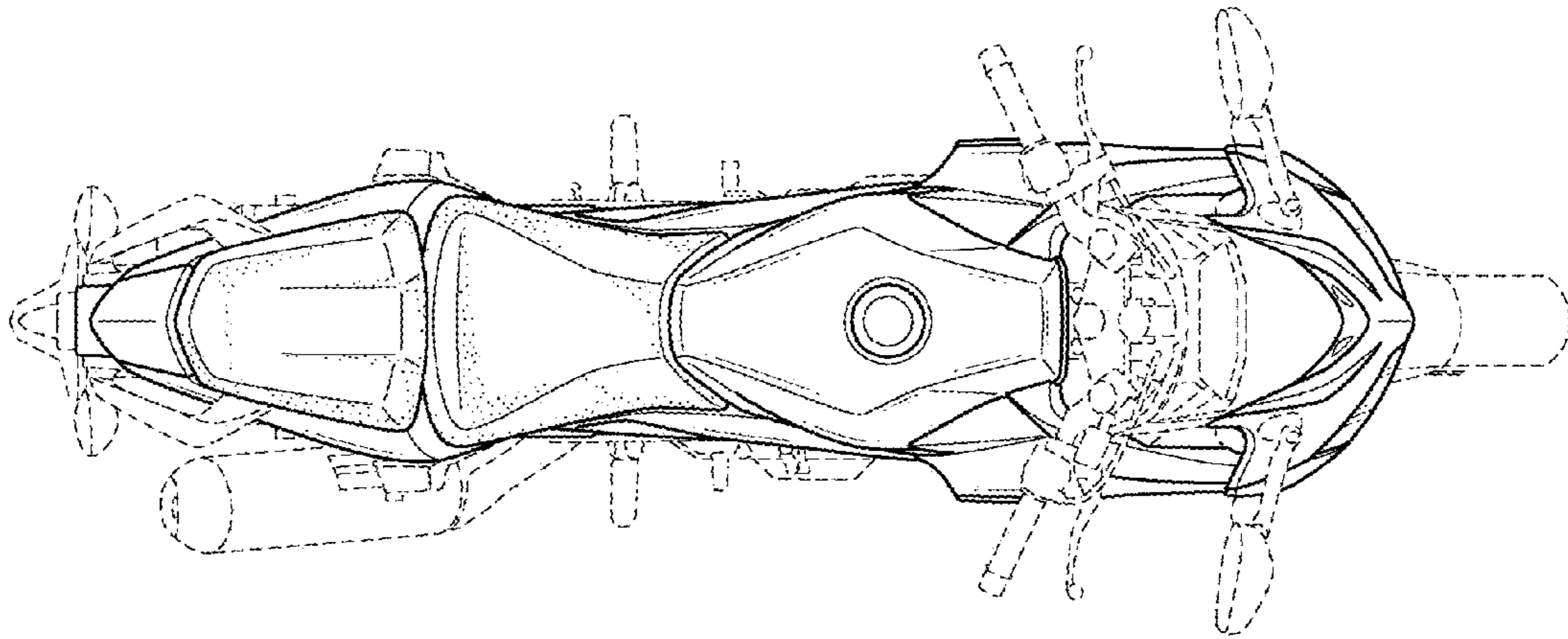

FIG. 10

