



US00D689389S

(12) **United States Design Patent**  
**Berme**

(10) **Patent No.:** **US D689,389 S**  
(45) **Date of Patent:** **\*\* Sep. 10, 2013**

- (54) **DUAL FORCE PLATE**
- (71) Applicant: **Bertec Corporation**, Columbus, OH (US)
- (72) Inventor: **Necip Berme**, Worthington, OH (US)
- (73) Assignee: **Bertec Corporation**, Columbus, OH (US)
- (\*\*) Term: **14 Years**
- (21) Appl. No.: **29/452,195**
- (22) Filed: **Apr. 12, 2013**
- (51) **LOC (9) Cl.** ..... **10-04**
- (52) **U.S. Cl.**  
USPC ..... **D10/83; D10/87; D10/94**
- (58) **Field of Classification Search**  
USPC ..... D10/83-85, 87, 91-94; 73/862.041, 73/862.626, 828; 177/126, 211, 238-245, 177/256; 345/672; 463/36; 600/592; 702/41, 702/42, 87, 101, 102, 141, 174  
See application file for complete search history.

6,936,016	B2	8/2005	Berme et al.	
7,418,875	B2*	9/2008	Kohno et al.	73/828
D611,855	S*	3/2010	Minagawa et al.	D10/85
D611,856	S*	3/2010	Minagawa et al.	D10/85
7,955,279	B2*	6/2011	Berthonnaud et al.	600/595
7,989,713	B2*	8/2011	Hulburt et al.	177/126
7,994,440	B2*	8/2011	Oseko et al.	177/238
8,152,640	B2*	4/2012	Shirakawa et al.	463/36
8,181,541	B2	5/2012	Berme	
8,315,822	B2	11/2012	Berme et al.	
8,315,823	B2	11/2012	Berme et al.	
8,389,878	B2*	3/2013	Abercrombie et al.	177/126
2003/0216656	A1	11/2003	Berme et al.	
2008/0228110	A1	9/2008	Berme	
2011/0277562	A1	11/2011	Berme et al.	
2012/0266648	A1	10/2012	Berme et al.	
2012/0271565	A1	10/2012	Berme et al.	

**OTHER PUBLICATIONS**

U.S. Appl. No. 13/348,506, entitled "Force Measurement System Having A Plurality of Measurement Surfaces", Inventor: Dr. Necip Berme, filed Jan. 11, 2012.

\* cited by examiner

*Primary Examiner* — Antoine D Davis  
(74) *Attorney, Agent, or Firm* — The Law Office of Patrick F. O'Reilly, III, LLC

(56) **References Cited**

**U.S. PATENT DOCUMENTS**

3,890,958	A*	6/1975	Fister et al.	600/527
4,548,289	A*	10/1985	Mechling	600/587
4,739,848	A*	4/1988	Tulloch	177/211
4,830,021	A*	5/1989	Thornton	600/520
4,880,069	A*	11/1989	Bradley	177/211
D322,229	S*	12/1991	Koster et al.	D10/87
5,562,572	A*	10/1996	Carmein	482/4
5,708,236	A*	1/1998	Shaanan et al.	177/256
5,750,937	A*	5/1998	Johnson et al.	177/25.11
6,038,488	A	3/2000	Barnes et al.	
6,098,025	A*	8/2000	Bae	702/94
6,113,237	A	9/2000	Ober et al.	
6,152,564	A	11/2000	Ober et al.	
6,222,137	B1*	4/2001	Handford	177/126
6,295,878	B1	10/2001	Berme	
6,354,155	B1	3/2002	Berme	
6,389,883	B1	5/2002	Berme et al.	
6,812,414	B2*	11/2004	Nakagawa	177/211
6,836,744	B1*	12/2004	Asphahani et al.	702/141

(57) **CLAIM**

The ornamental design for a dual force plate, as shown and described.

**DESCRIPTION**

FIG. 1 is a right-rear perspective view of a first embodiment of a dual force plate showing my new design;  
FIG. 2 is a top plan view of the embodiment shown in FIG. 1;  
FIG. 3 is a bottom plan view of the embodiment shown in FIG. 1;  
FIG. 4 is a left side elevational view of the embodiment shown in FIG. 1;  
FIG. 5 is a right side elevational view of the embodiment shown in FIG. 1;  
FIG. 6 is an enlarged left side elevational view of the embodiment shown in FIG. 1;

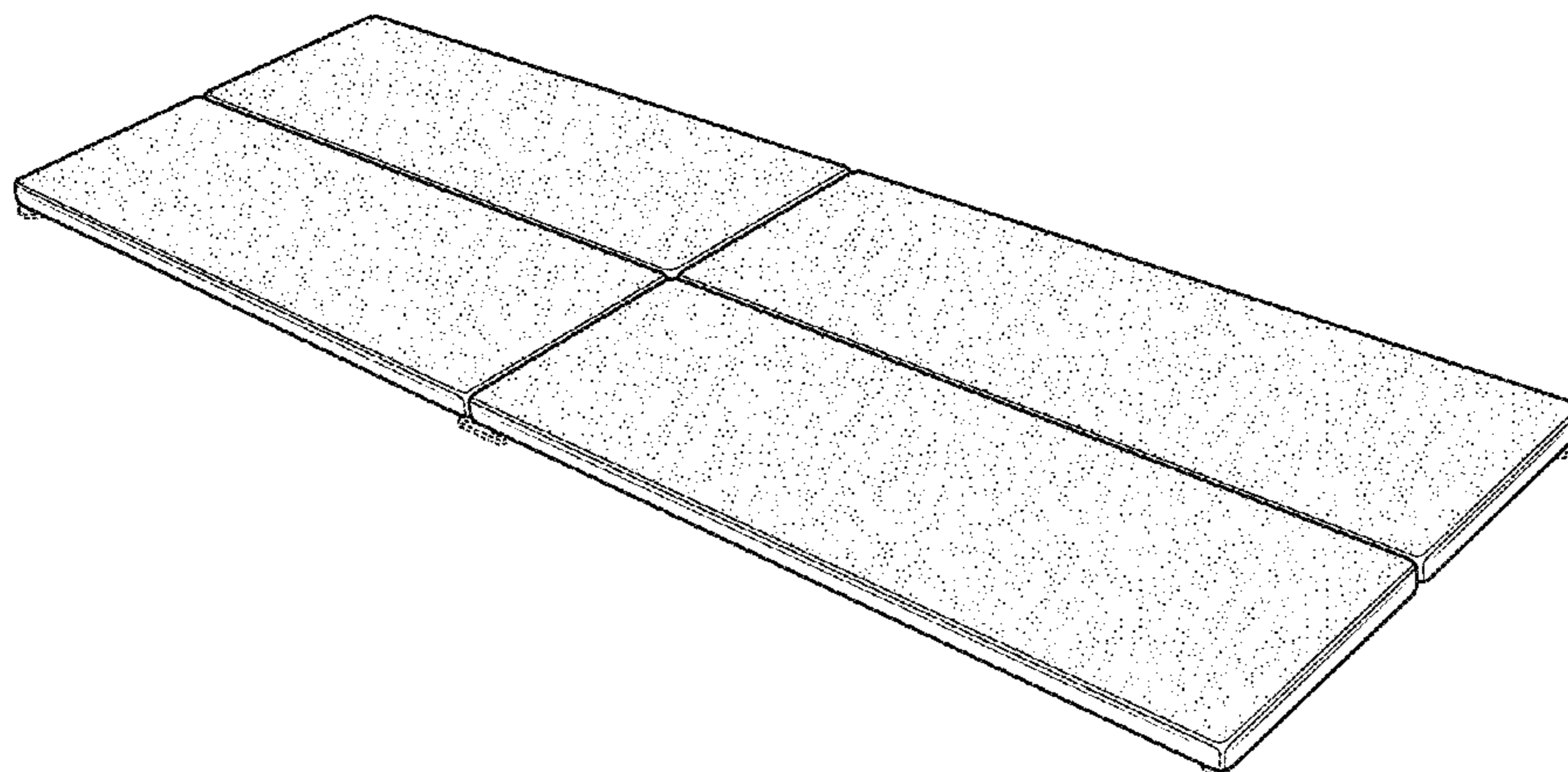

FIG. 7 is an enlarged right side elevational view of the embodiment shown in FIG. 1;

FIG. 8 is a rear elevational view of the embodiment shown in FIG. 1;

FIG. 9 is a front elevational view of the embodiment shown in FIG. 1;

FIG. 10 is a rear-left perspective view of the embodiment shown in FIG. 1;

FIG. 11 is an enlarged partial frontal perspective view of the embodiment shown in FIG. 1, wherein the gaps between plate surfaces are illustrated together with the force transducer beams which are visible through the gaps;

FIG. 12 is a further enlarged partial frontal perspective view of the embodiment shown in FIG. 1, wherein the gap between two plates surfaces is illustrated together with the front force transducer beam which is visible through the gap;

FIG. 13 is a right-rear perspective view of a second embodiment of a dual force plate showing my new design;

FIG. 14 is a top plan view of the embodiment shown in FIG. 13;

FIG. 15 is a bottom plan view of the embodiment shown in FIG. 13;

FIG. 16 is a left side elevational view of the embodiment shown in FIG. 13;

FIG. 17 is a right side elevational view of the embodiment shown in FIG. 13;

FIG. 18 is a rear elevational view of the embodiment shown in FIG. 13;

FIG. 19 is a front elevational view of the embodiment shown in FIG. 13;

FIG. 20 is a rear-left perspective view of the embodiment shown in FIG. 13;

FIG. 21 is an enlarged partial frontal perspective view of the embodiment shown in FIG. 13, wherein the gap between the two plate surfaces is illustrated together with the front and rear force transducer beams which are visible through the gap; and,

FIG. 22 is a further enlarged partial frontal perspective view of the embodiment shown in FIG. 13, wherein the gap between the two plate surfaces is illustrated together with the front force transducer beam which is visible through the gap. The broken line portions of the drawing figures are included to show unclaimed subject matter only and form no part of the claimed design.

**1 Claim, 16 Drawing Sheets**

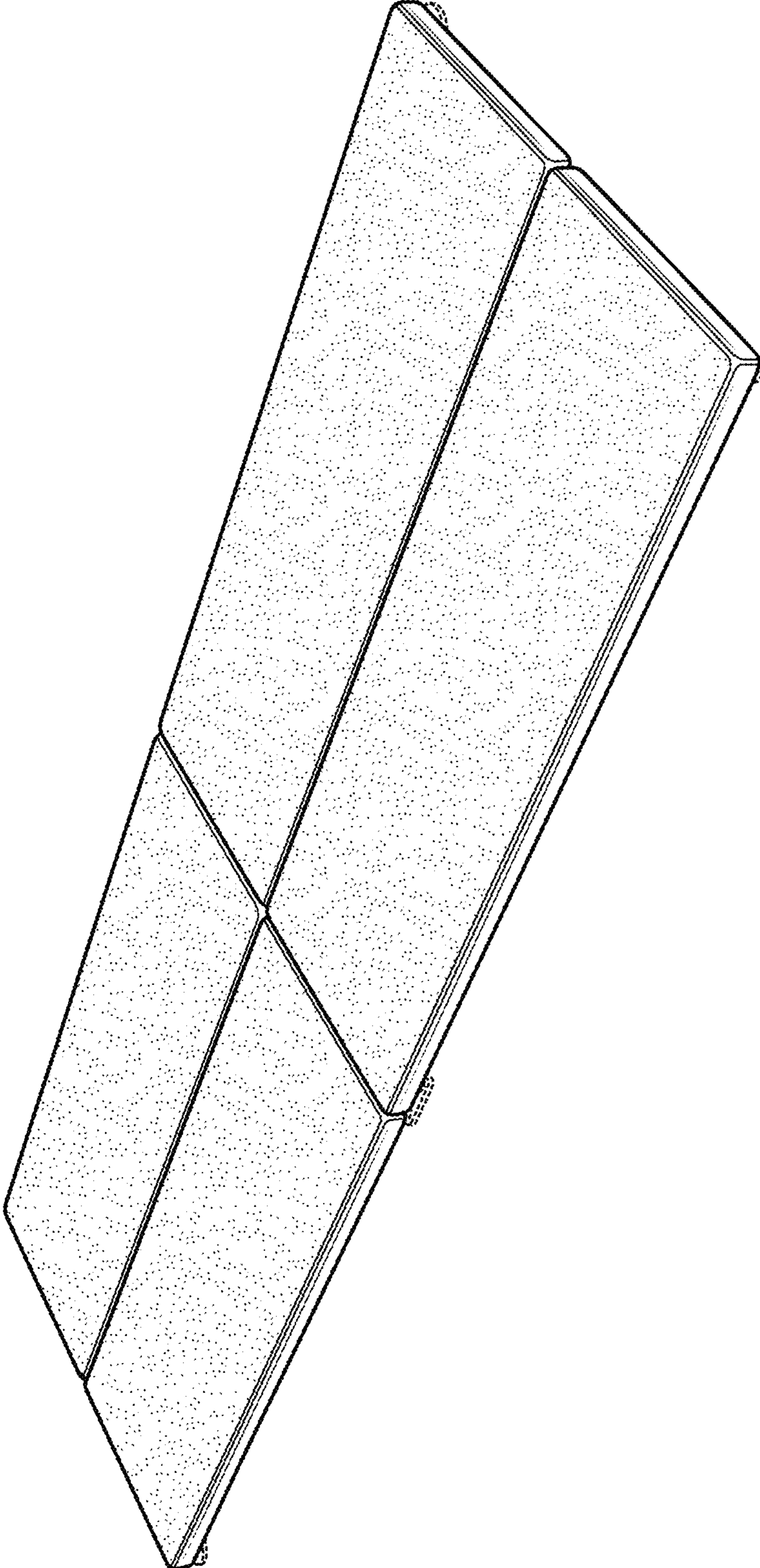

**FIG. 1**

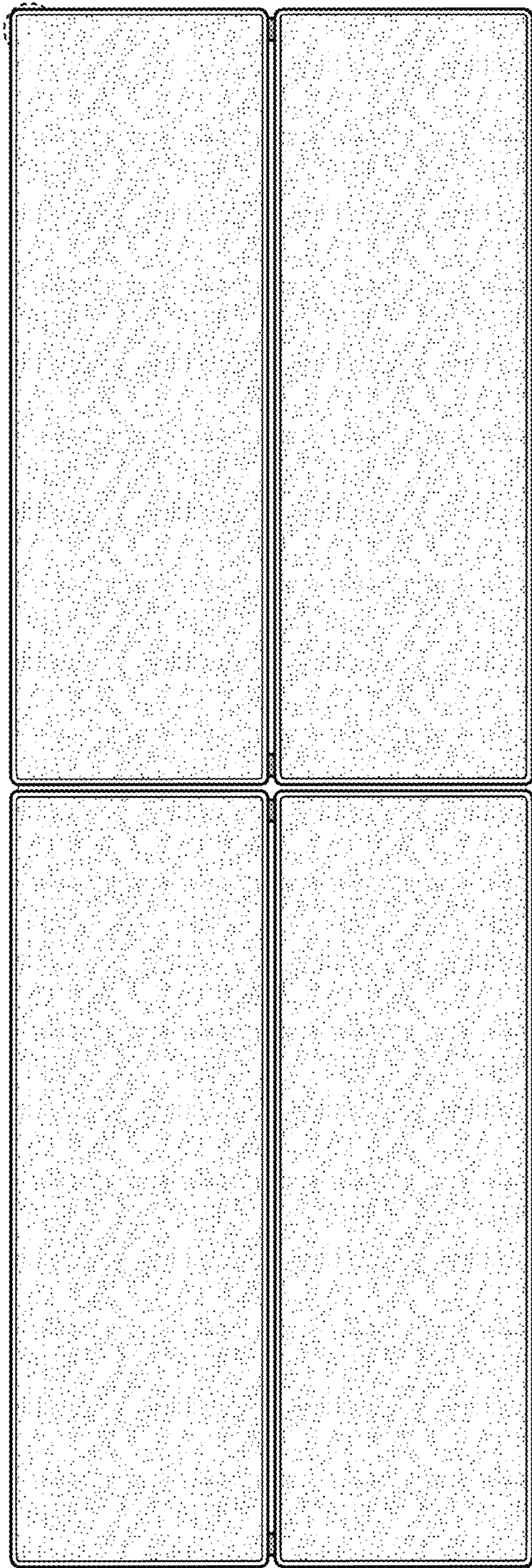
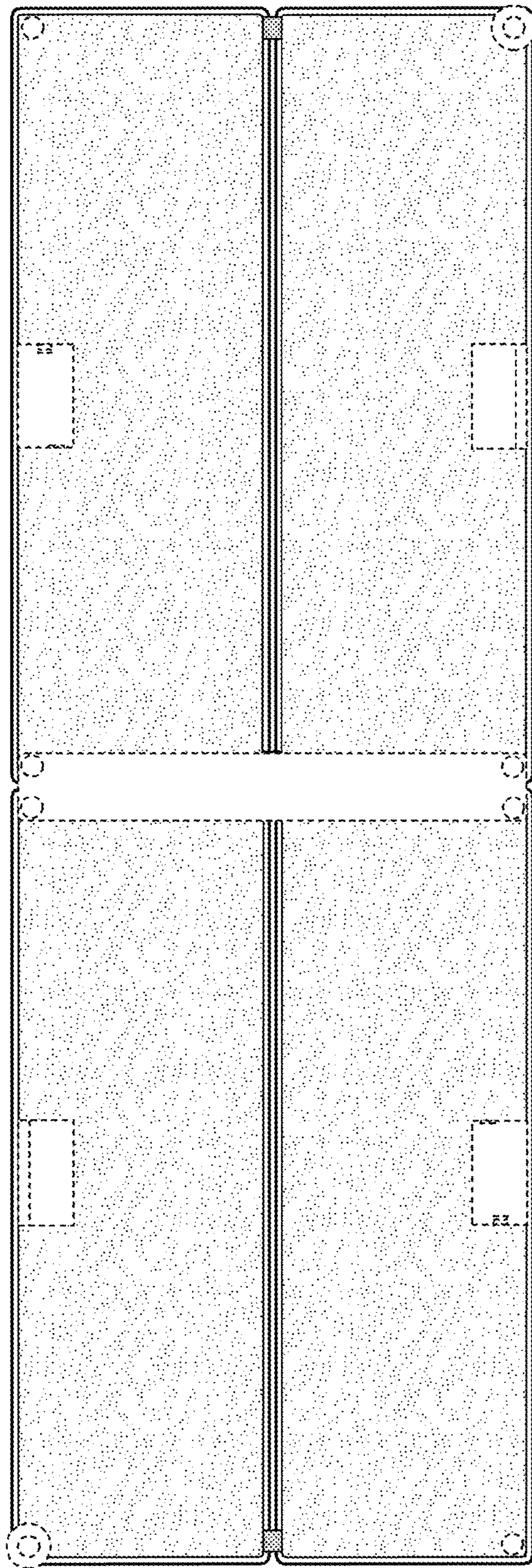

FIG. 2



**FIG. 3**



FIG. 4



FIG. 5

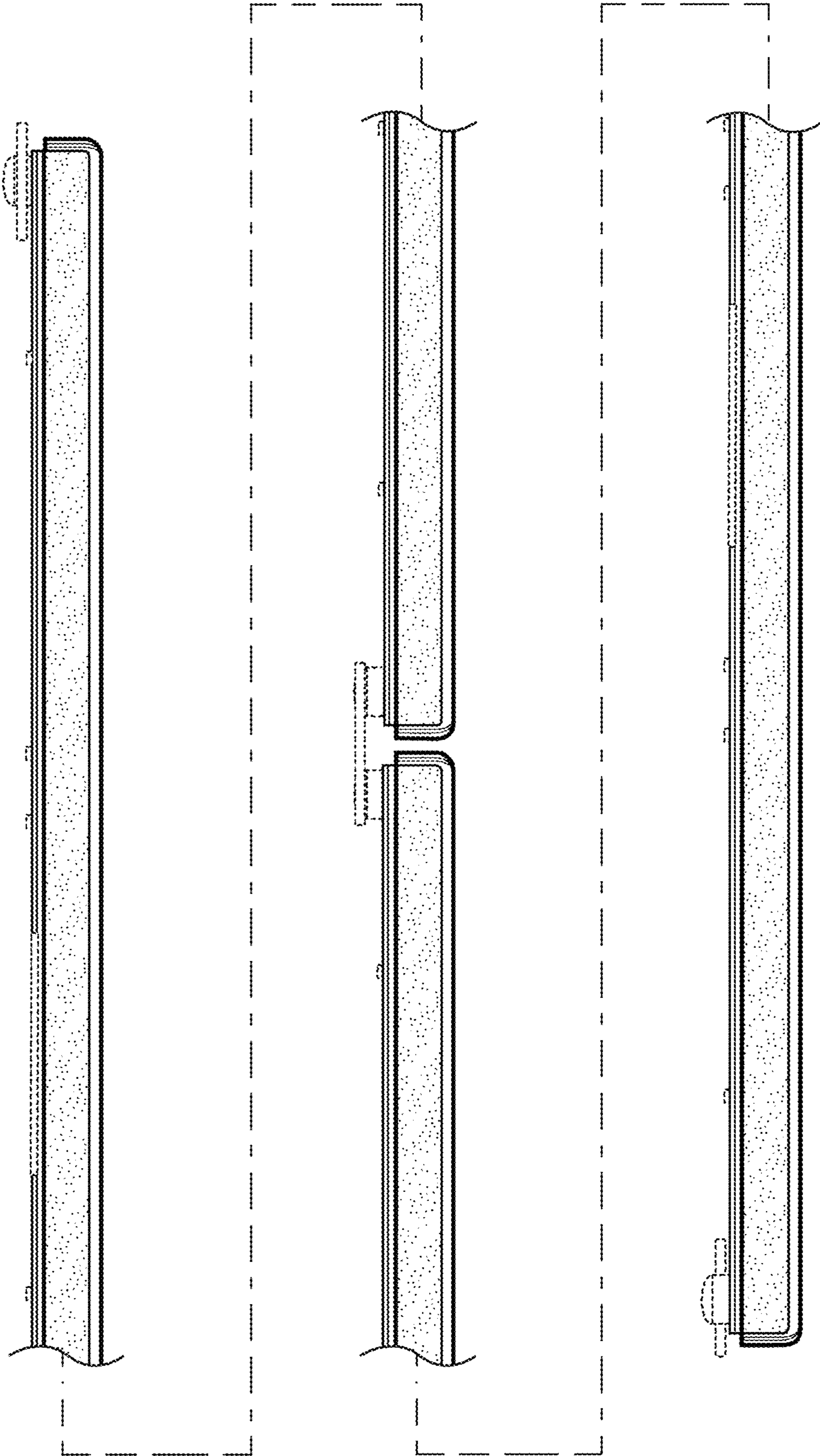

**FIG. 6**

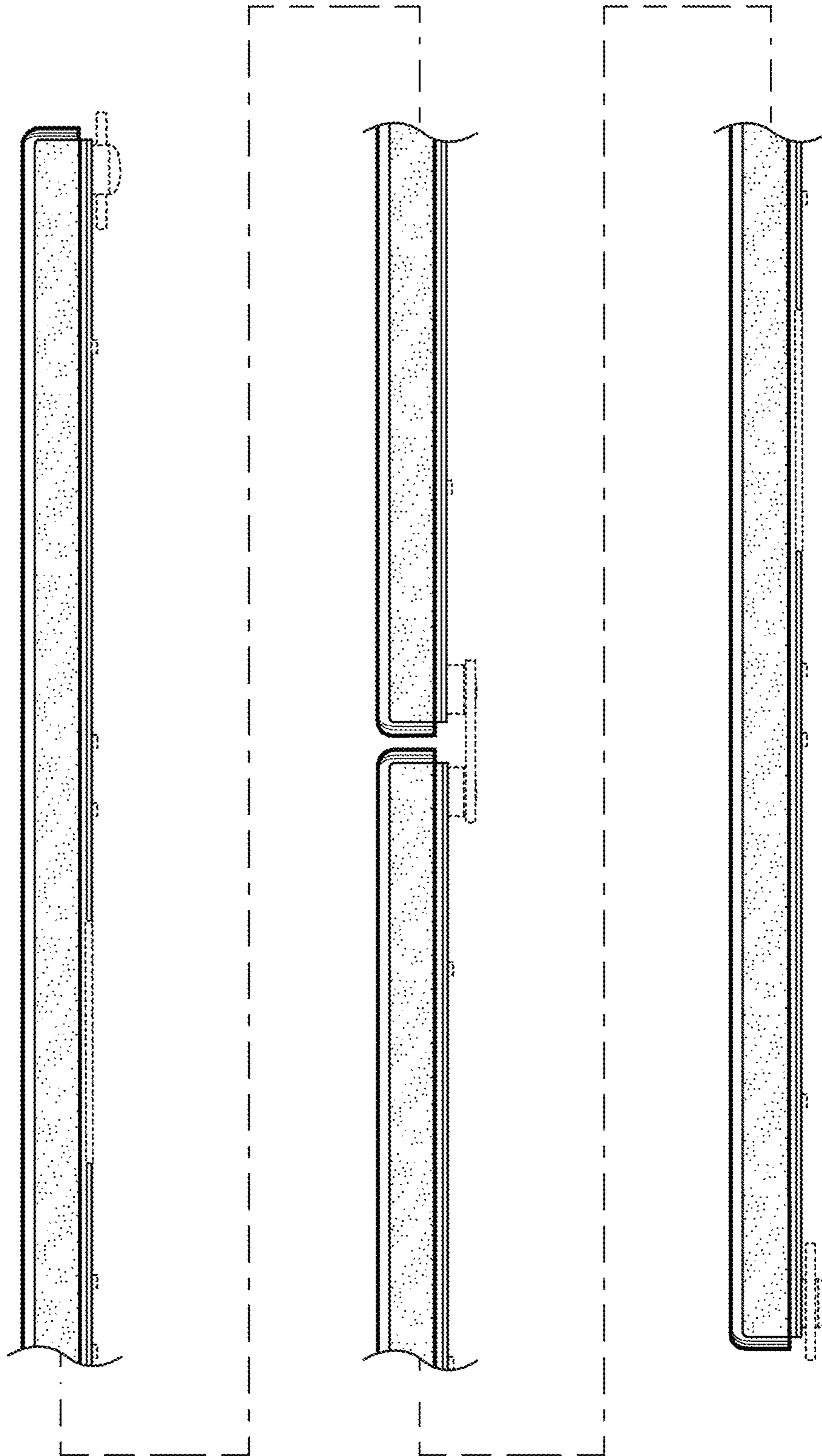

**FIG. 7**



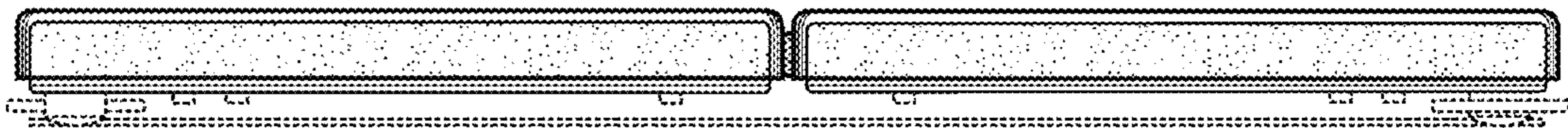

FIG. 8

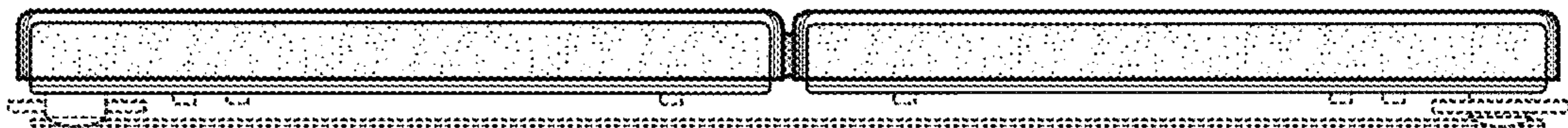

FIG. 9

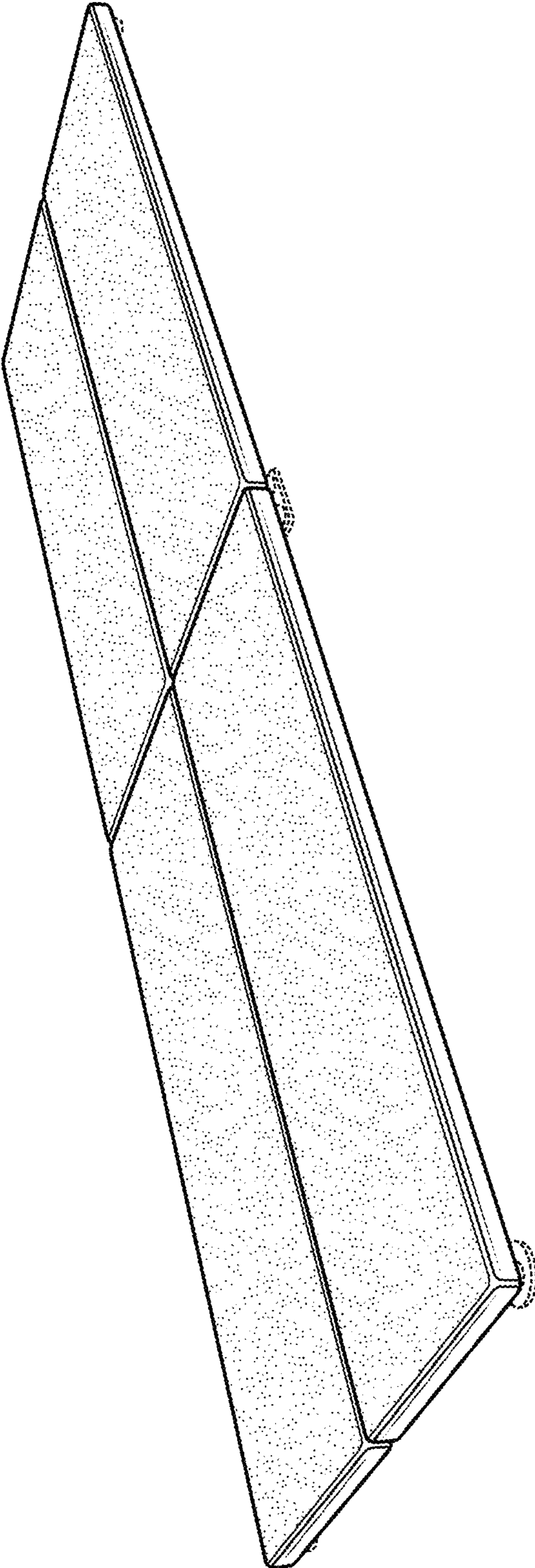
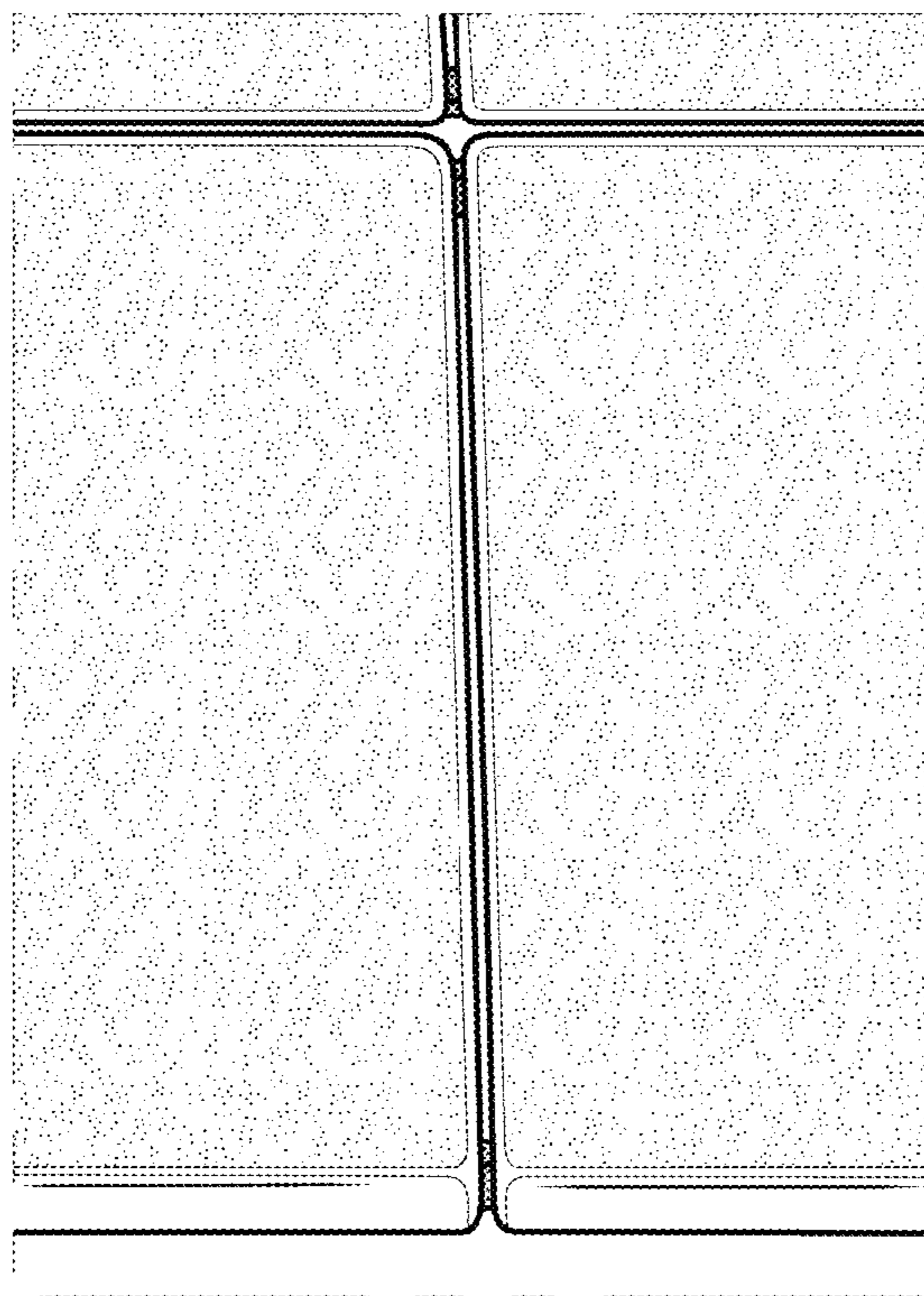
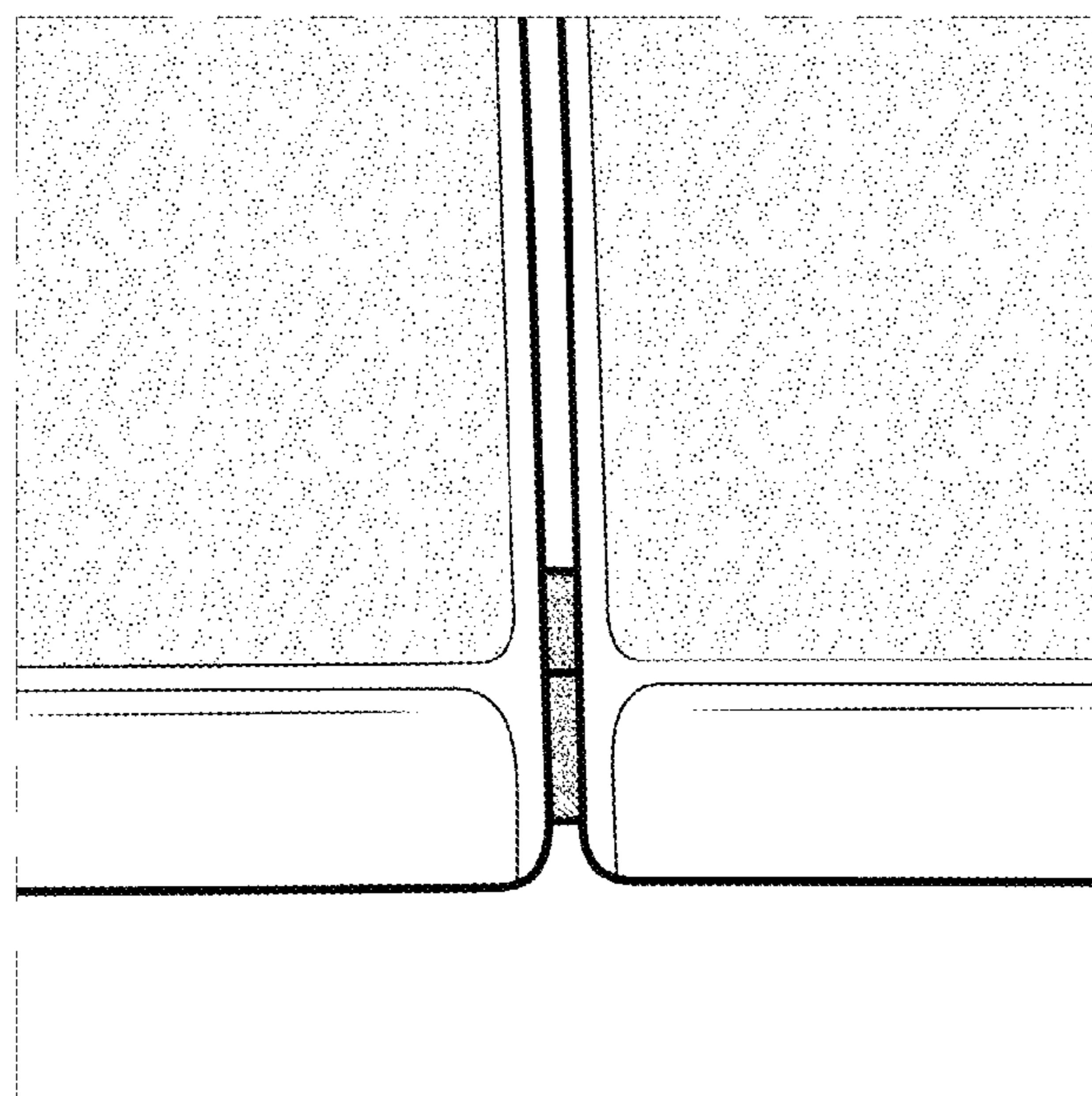

FIG. 10



**FIG. 11**



**FIG. 12**

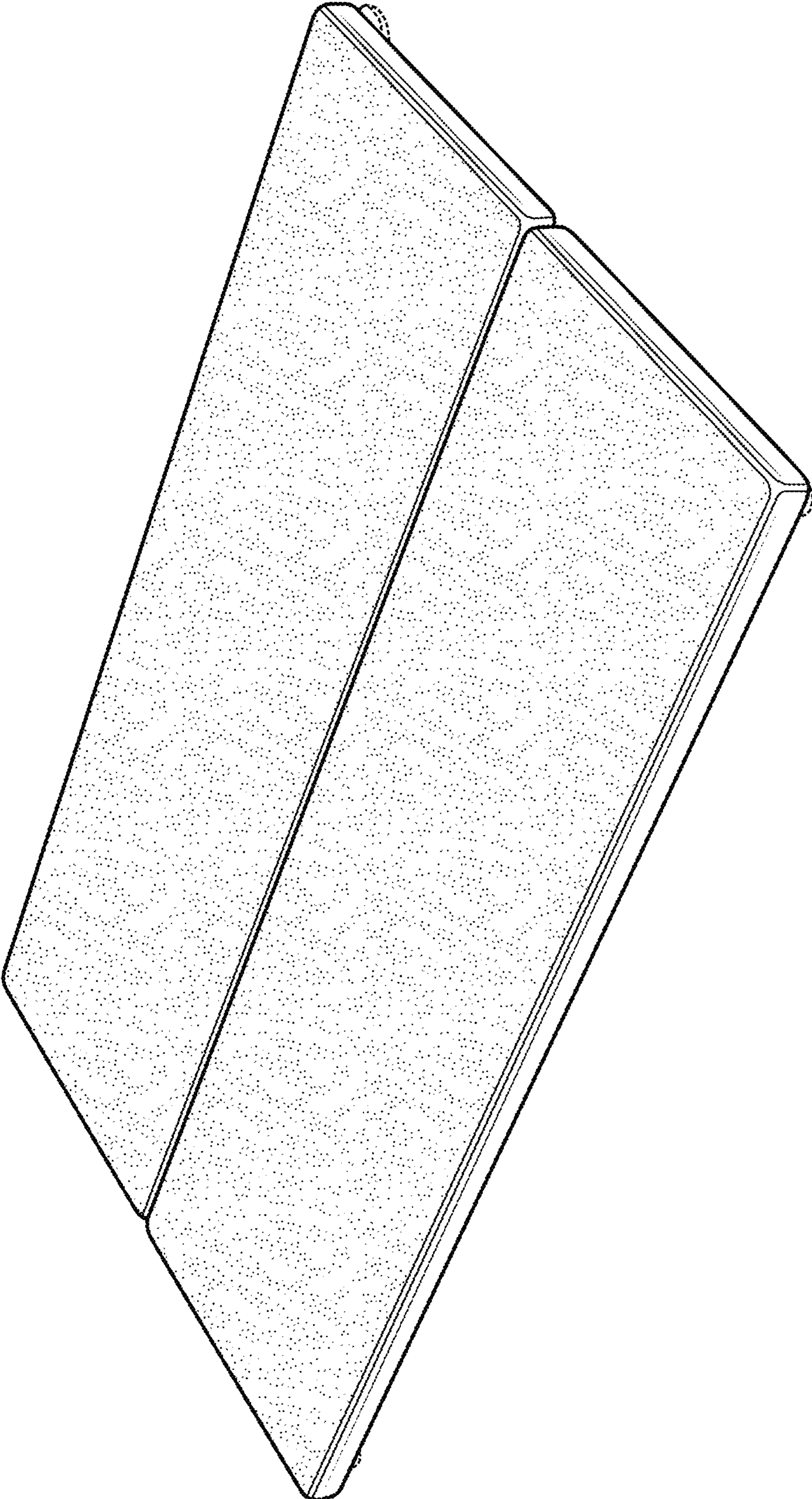

FIG. 13

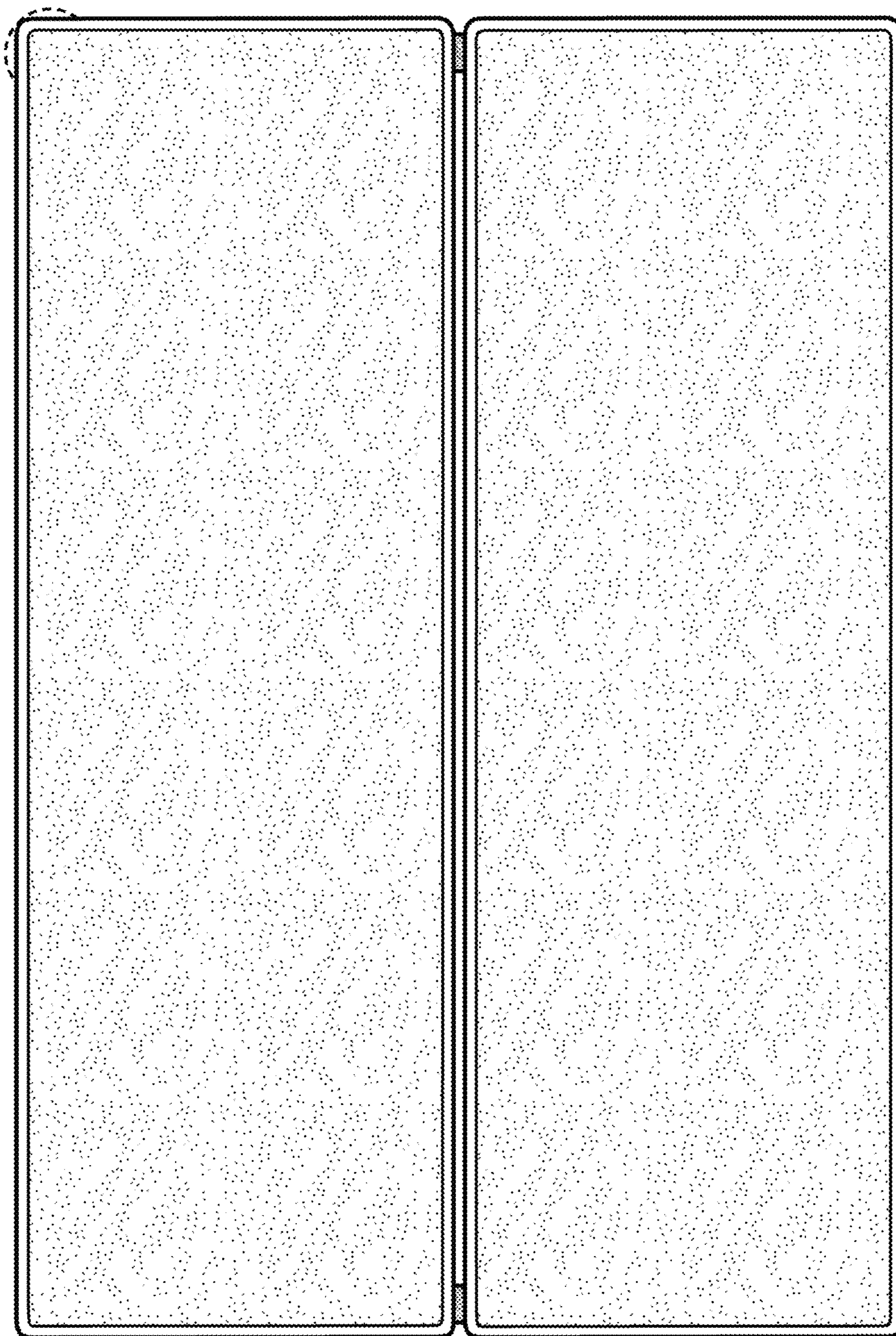

FIG. 14

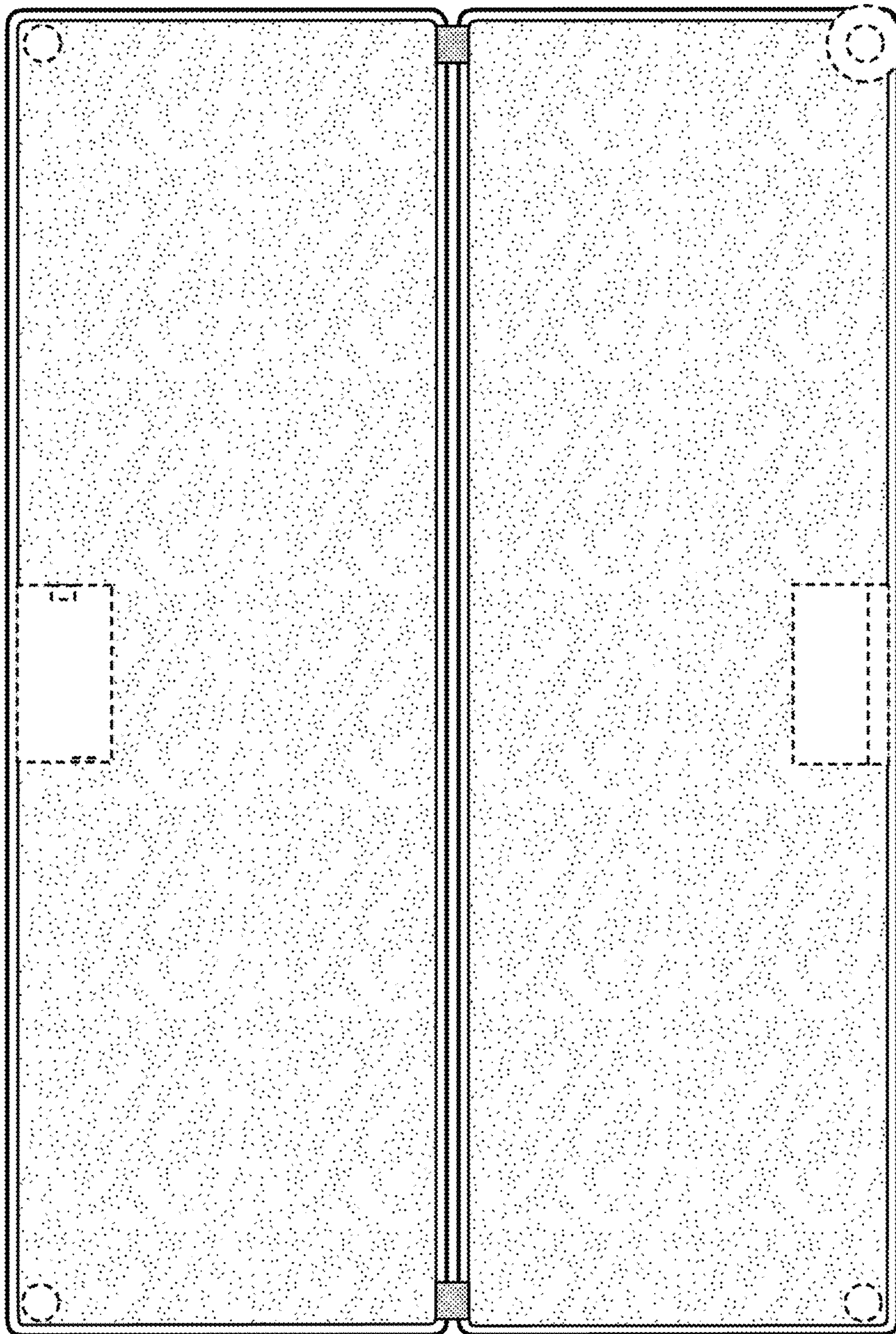

FIG. 15

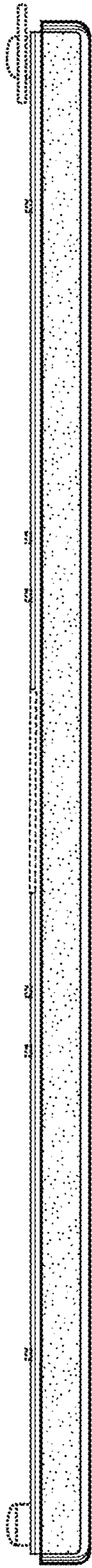

FIG. 16

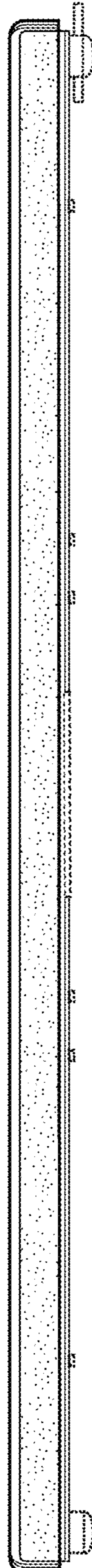

FIG. 17

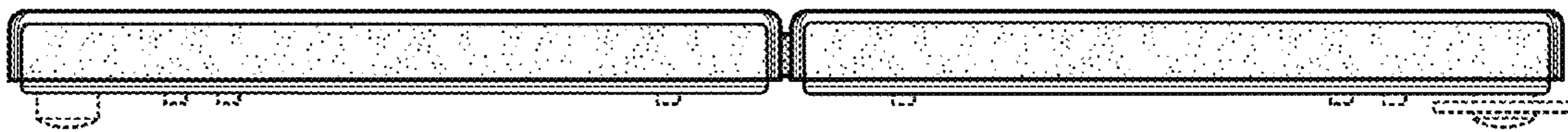

FIG. 18

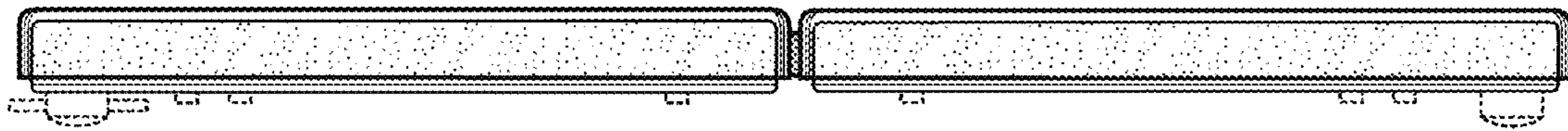

FIG. 19



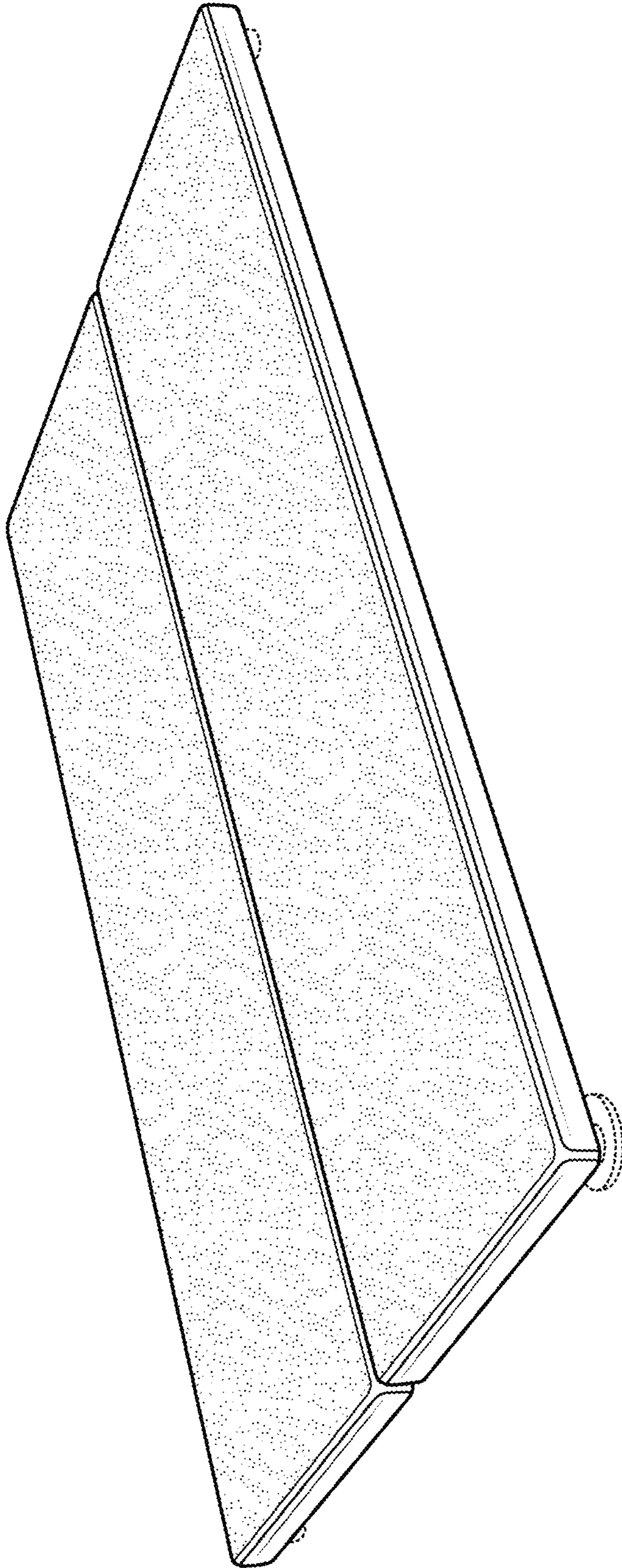
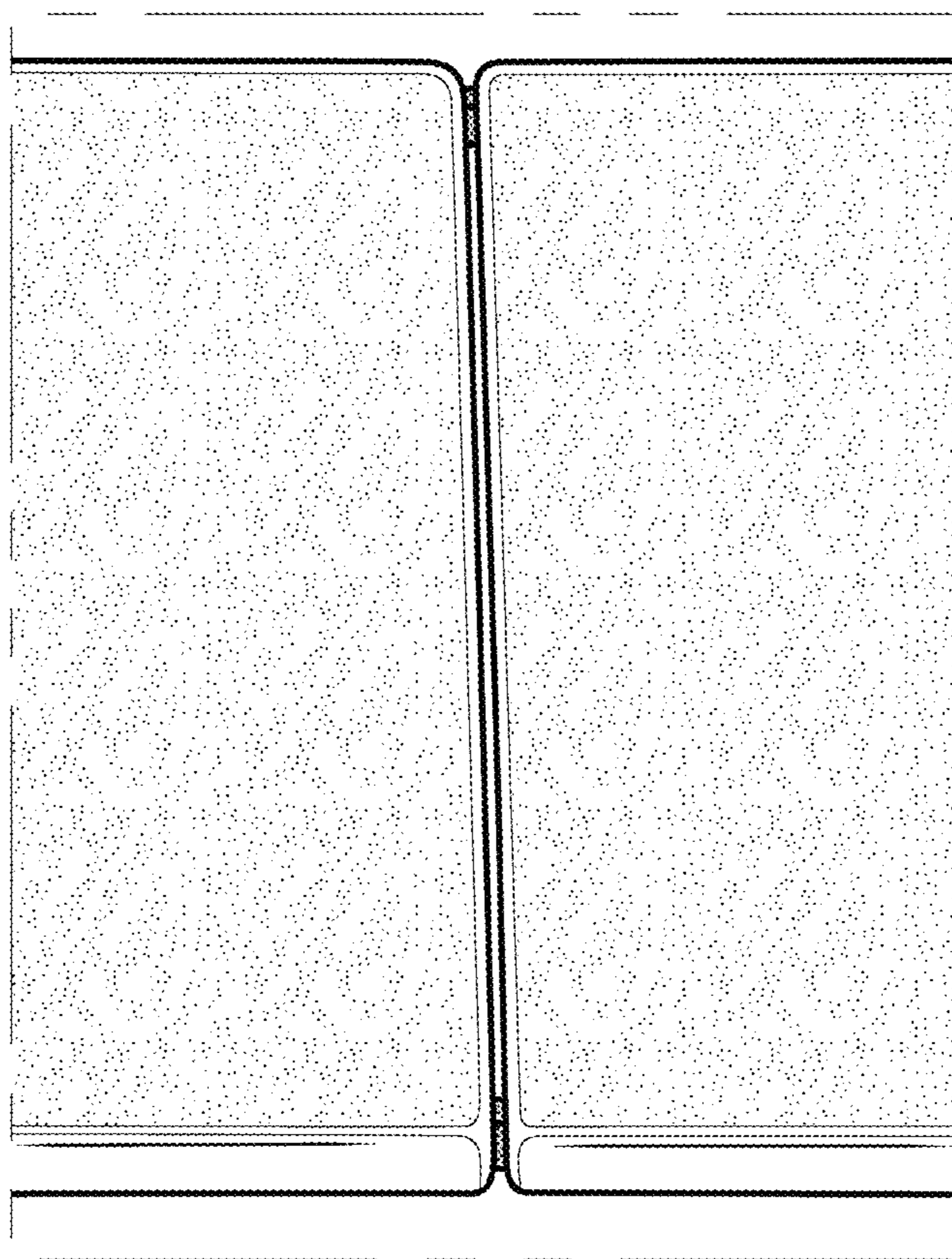
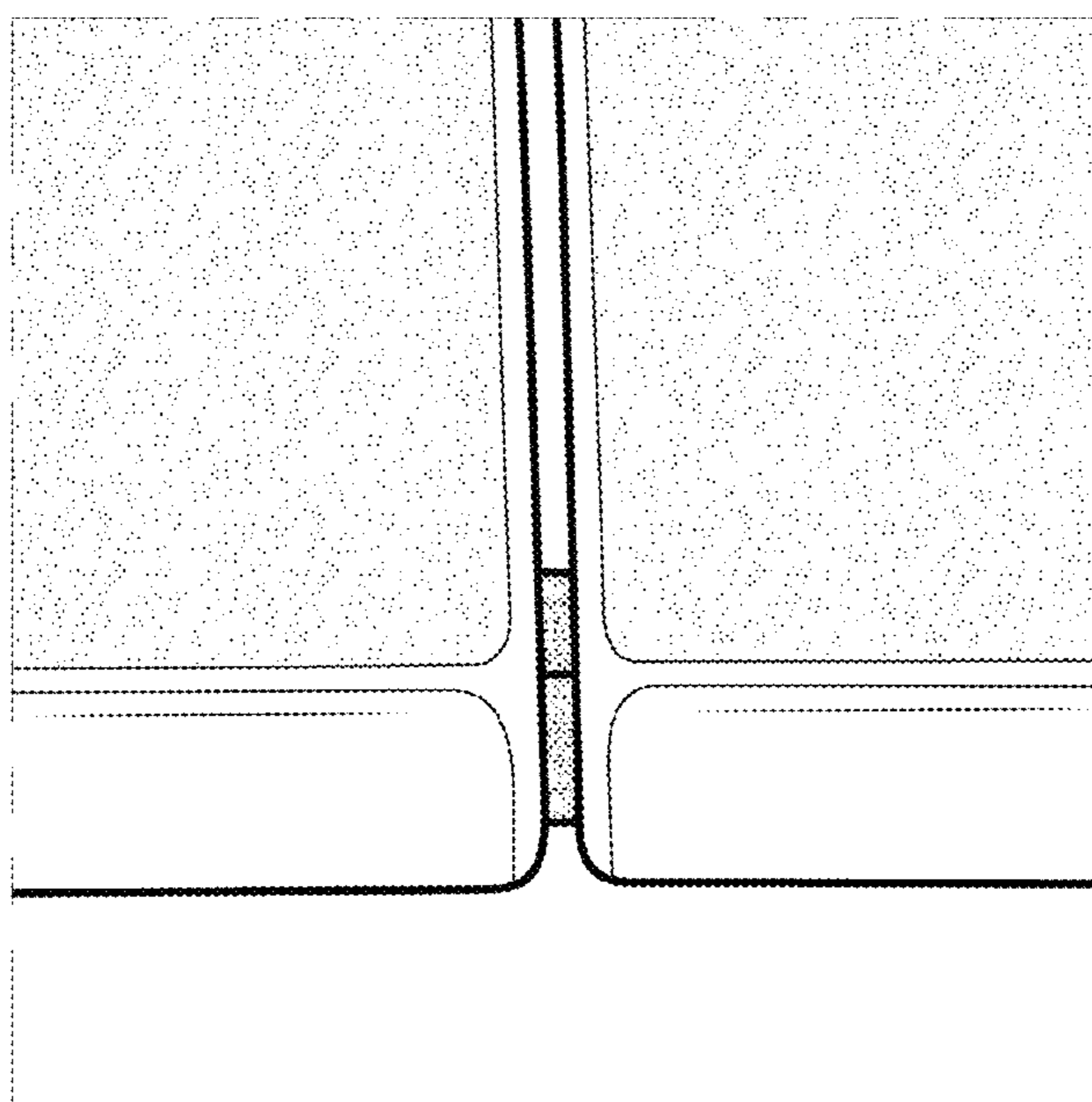

FIG. 20



**FIG. 21**



**FIG. 22**