



US00D689332S

(12) **United States Design Patent**
Krasner

(10) **Patent No.:** **US D689,332 S**

(45) **Date of Patent:** **** Sep. 10, 2013**

(54) **PET WATER BOTTLE**

D318,394 S * 7/1991 Larimer D7/300.1
5,409,151 A 4/1995 Freimark
5,553,957 A 9/1996 Dornbusch et al.

(76) Inventor: **Mark Krasner**, Marietta, GA (US)

(Continued)

(**) Term: **14 Years**

FOREIGN PATENT DOCUMENTS

(21) Appl. No.: **29/426,966**

CA 135973 1/2011
CN ZL201030223213.3 10/2011

(22) Filed: **Jul. 12, 2012**

Primary Examiner — Marianne Pandozzi

(74) *Attorney, Agent, or Firm* — Gardner Groff Greenwald & Villanueva PC

Related U.S. Application Data

(63) Continuation-in-part of application No. 12/814,947, filed on Jun. 14, 2010.

(57) **CLAIM**

The ornamental design of a pet water bottle, as shown and described.

(51) **LOC (9) Cl.** **07-01**

DESCRIPTION

(52) **U.S. Cl.**
USPC **D7/510; D7/511; D7/300.1; D7/523; D30/132**

(58) **Field of Classification Search**
USPC D7/300.1, 510, 511, 523, 509; D30/132; D9/505, 503, 520; 220/703, 568, 713
See application file for complete search history.

FIG. 1 is a perspective view of a pet water bottle showing my new design;
FIG. 2 is a front view of the pet water bottle of FIG. 1.
FIG. 3 is a top view of the pet water bottle of FIG. 1.
FIG. 4 is a bottom view of the pet water bottle of FIG. 1.
FIG. 5 is a perspective view of a pet water bottle showing a second embodiment of my new design;
FIG. 6 is a top view of the pet water bottle of FIG. 5.
FIG. 7 is a bottom view of the pet water bottle of FIG. 5.
FIG. 8 is a front view of the pet water bottle of FIG. 5.
FIG. 9 is a perspective view of a pet water bottle showing a third embodiment of my new design;
FIG. 10 is a front view of the pet water bottle of FIG. 9.
FIG. 11 is a top view of the pet water bottle of FIG. 9; and,
FIG. 12 is a bottom view of the pet water bottle of FIG. 9.
The broken lines in the drawings are included for the purpose of illustration and forms no part of the claimed design.

(56) **References Cited**

U.S. PATENT DOCUMENTS

324,173 A 8/1885 Seips
1,568,691 A 1/1926 Pierson
1,740,223 A 12/1929 Burvenick
1,744,328 A 1/1930 Morley
1,748,483 A * 2/1930 Hyde 99/508
1,765,129 A 6/1930 Cooke
2,013,615 A * 9/1935 Fontan 220/568
2,035,560 A * 3/1936 McCarty 220/522
2,090,998 A 8/1937 Gessler
2,500,611 A 3/1950 Kereluck
D291,523 S 8/1987 Minuti
D304,551 S * 11/1989 Desgrippes D9/556

1 Claim, 5 Drawing Sheets

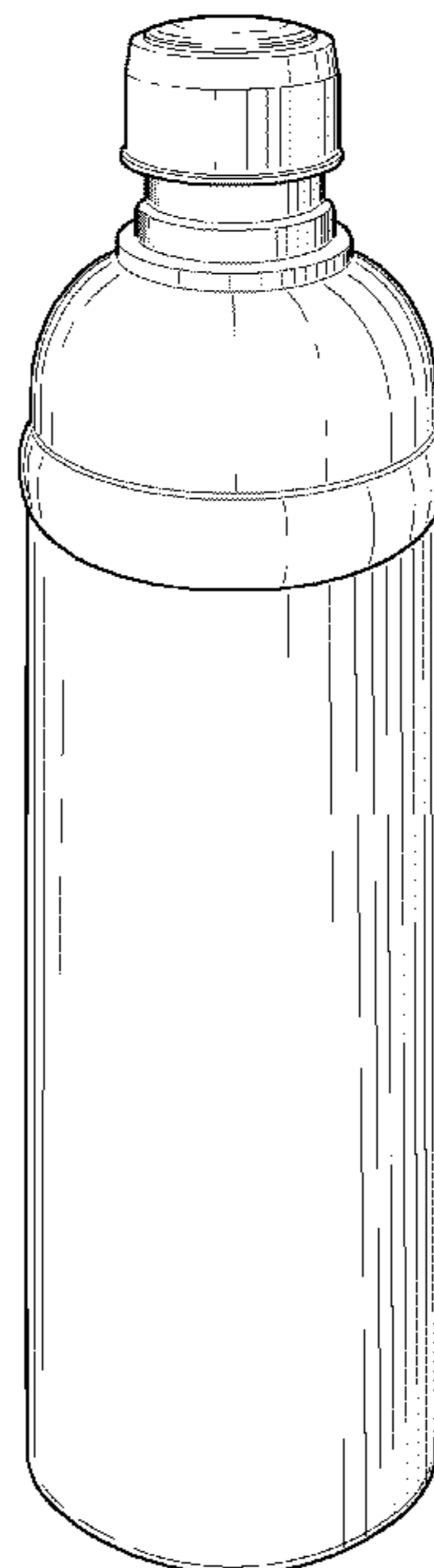

(56)

References Cited

U.S. PATENT DOCUMENTS

5,653,353 A 8/1997 Otto et al.
 D406,062 S * 2/1999 Brewer D9/520
 5,909,820 A 6/1999 Yeh
 6,095,708 A * 8/2000 Butaud 401/209
 6,105,803 A * 8/2000 Standish 220/8
 6,237,800 B1 5/2001 Barrett
 6,293,226 B1 9/2001 Hwang
 D480,590 S * 10/2003 Linz et al. D7/300.1
 D483,982 S * 12/2003 Irvine D7/300.1
 6,718,912 B2 4/2004 Pappas
 D489,627 S * 5/2004 Klitsner et al. D9/502
 D495,208 S * 8/2004 Putnam D7/509
 6,913,165 B2 * 7/2005 Linz et al. 220/568

7,117,818 B2 10/2006 Pappas et al.
 D576,495 S 9/2008 Slubski
 D577,584 S 9/2008 Porter et al.
 7,609,329 B2 10/2009 Baek et al.
 7,624,701 B2 12/2009 Ver Hage
 D611,819 S * 3/2010 Slubski D9/516
 D623,460 S * 9/2010 Krasner D7/300.1
 D624,177 S * 9/2010 Pratt et al. D24/111
 7,823,539 B2 11/2010 Keller et al.
 D648,177 S * 11/2011 Eyal D7/510
 D651,852 S * 1/2012 George D7/510
 D652,682 S * 1/2012 Eyal D7/510
 D654,752 S * 2/2012 Krasner D7/300.1
 2005/0184113 A1 8/2005 Capritta

* cited by examiner

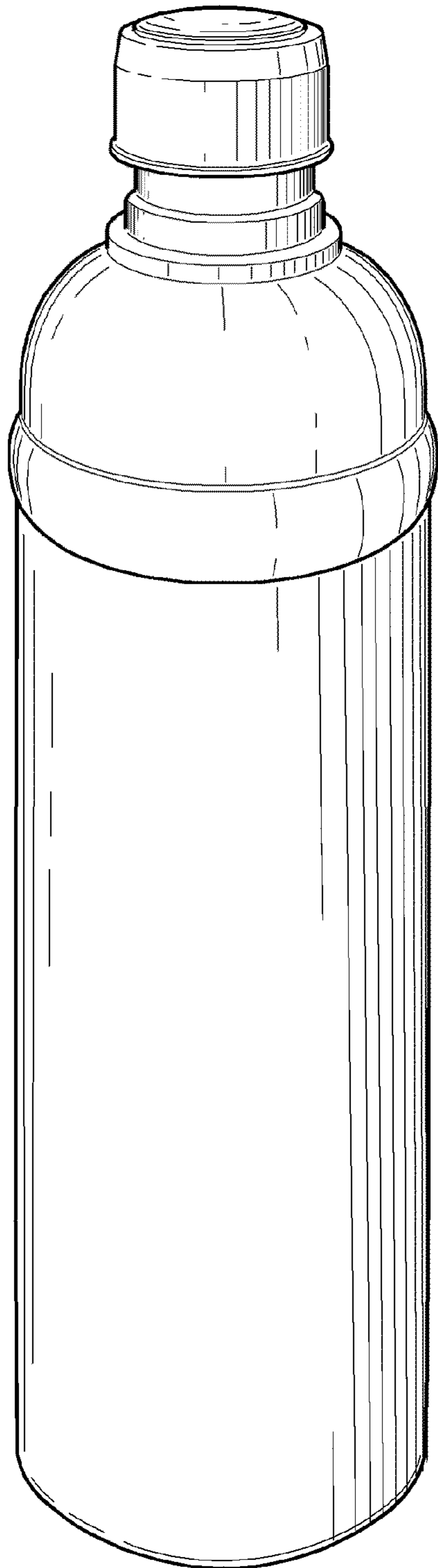

FIG. 1

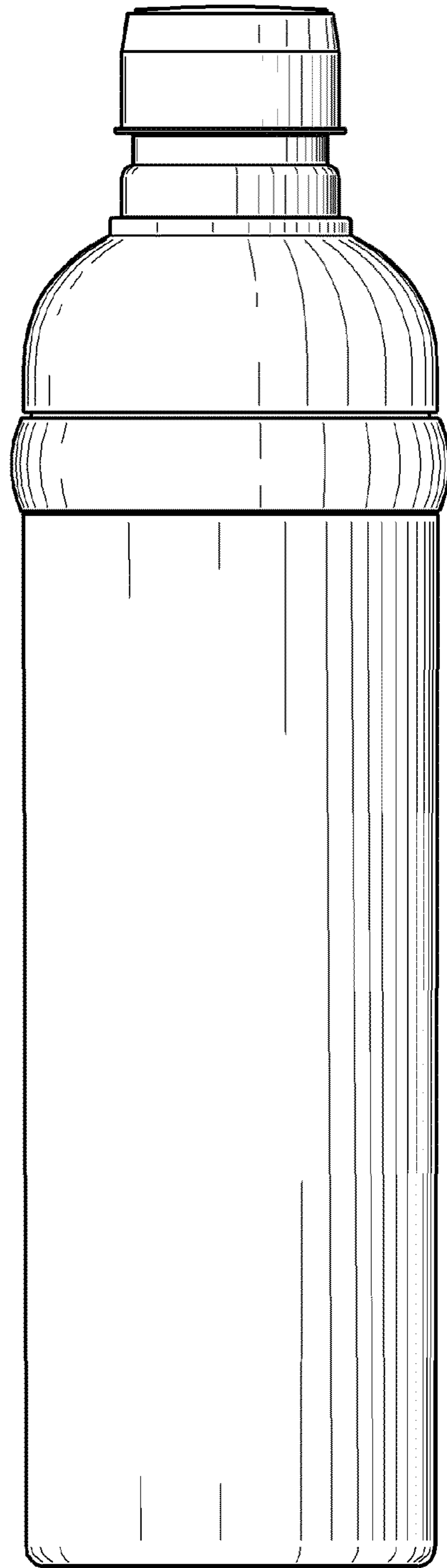

FIG. 2

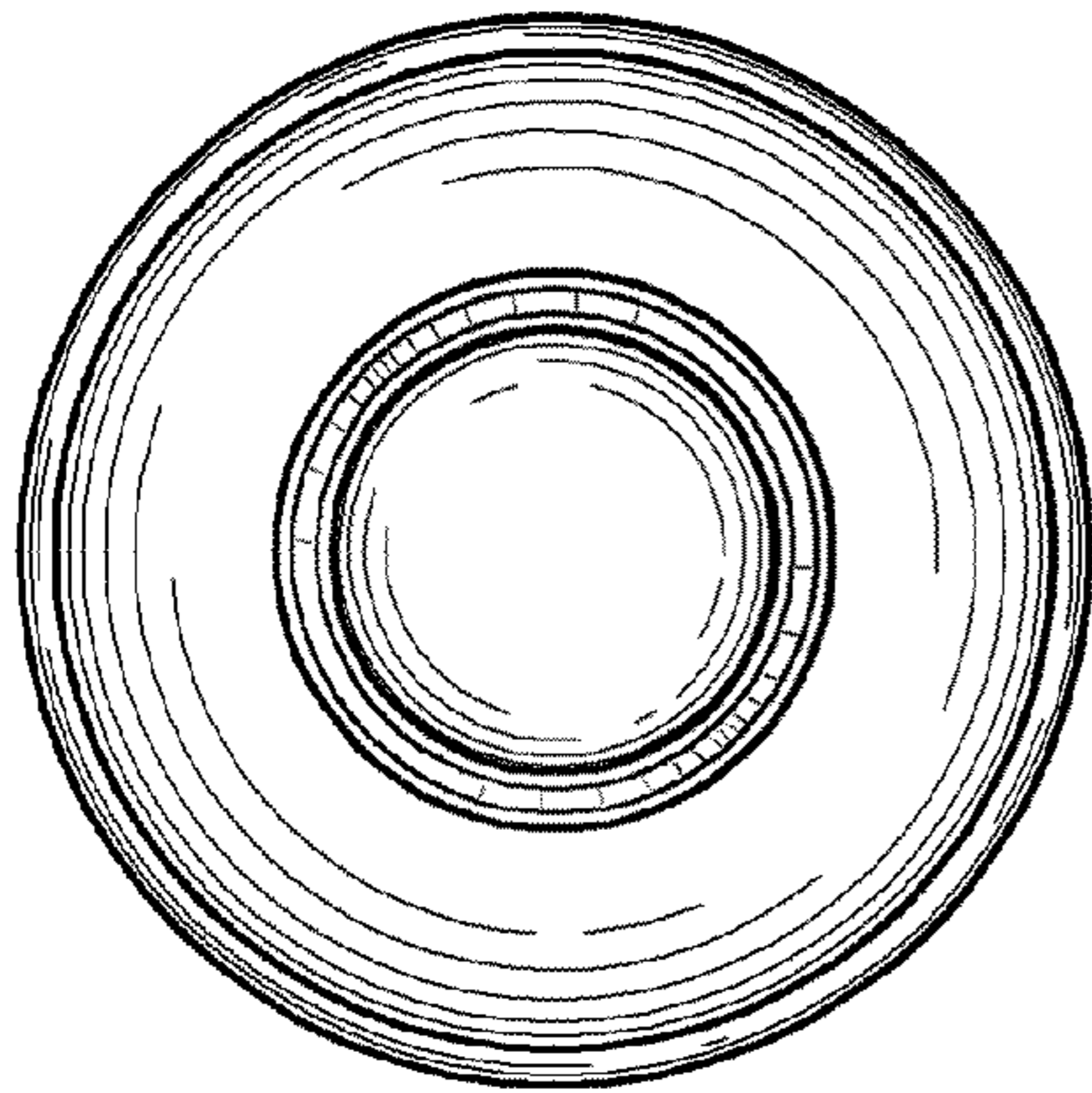

FIG. 3

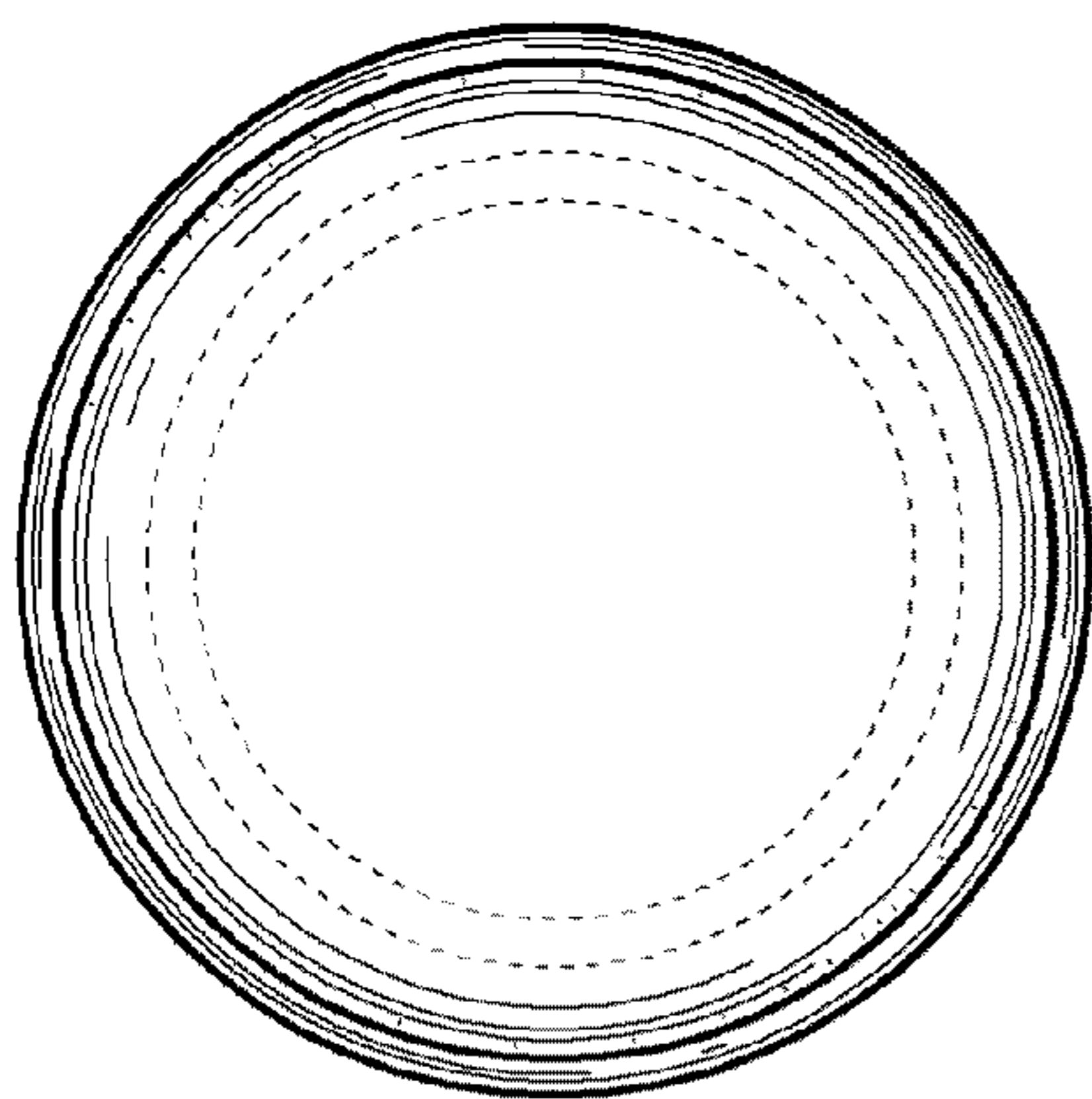

FIG. 4

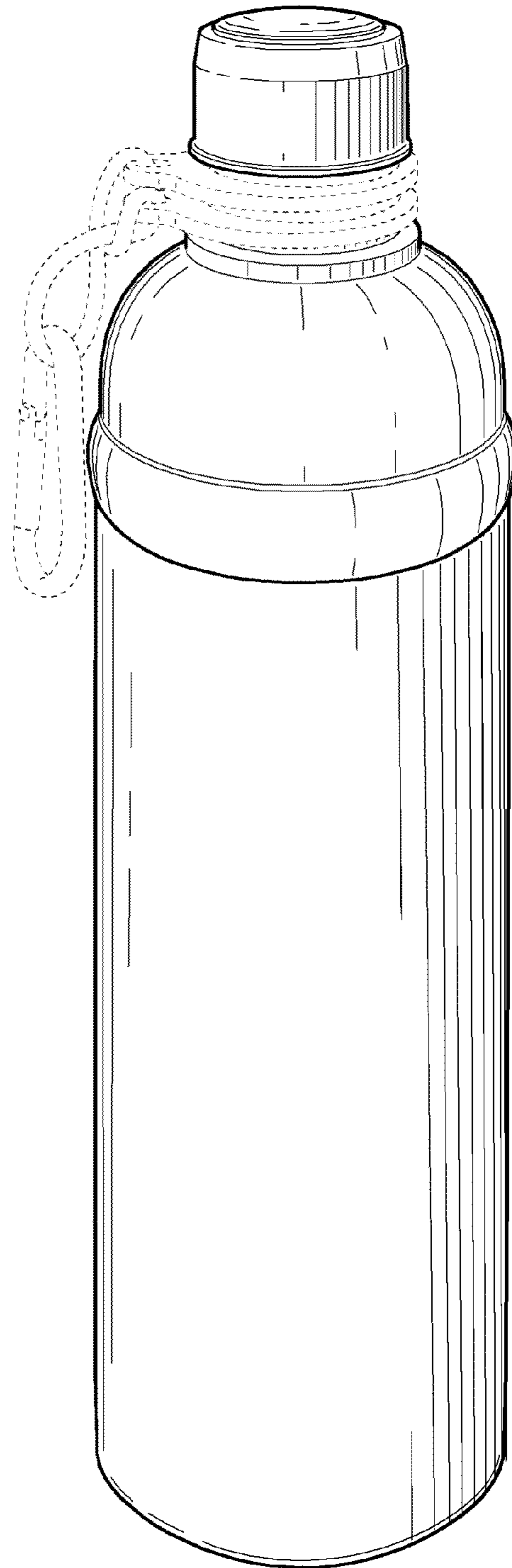

FIG. 5

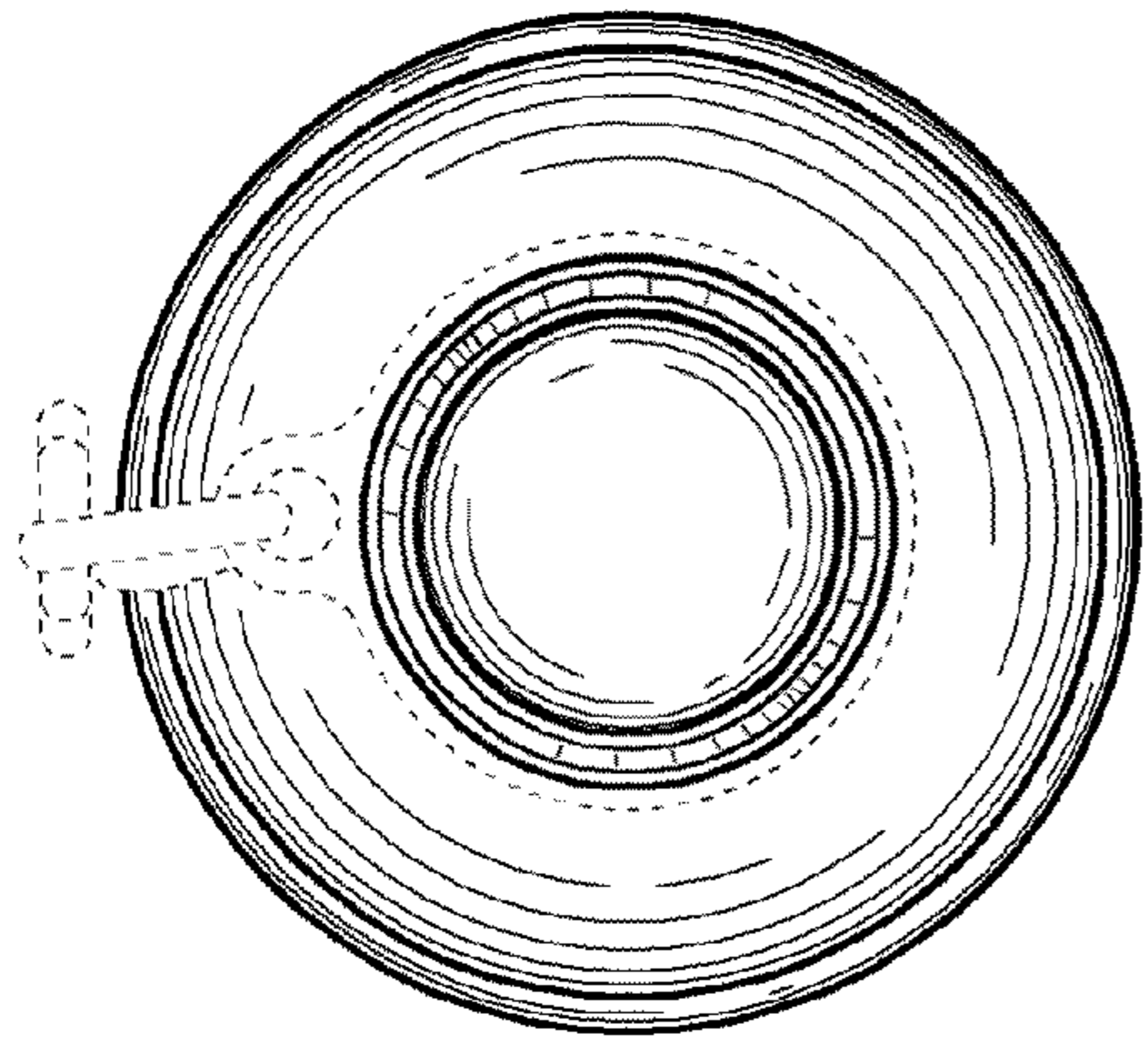

FIG. 6

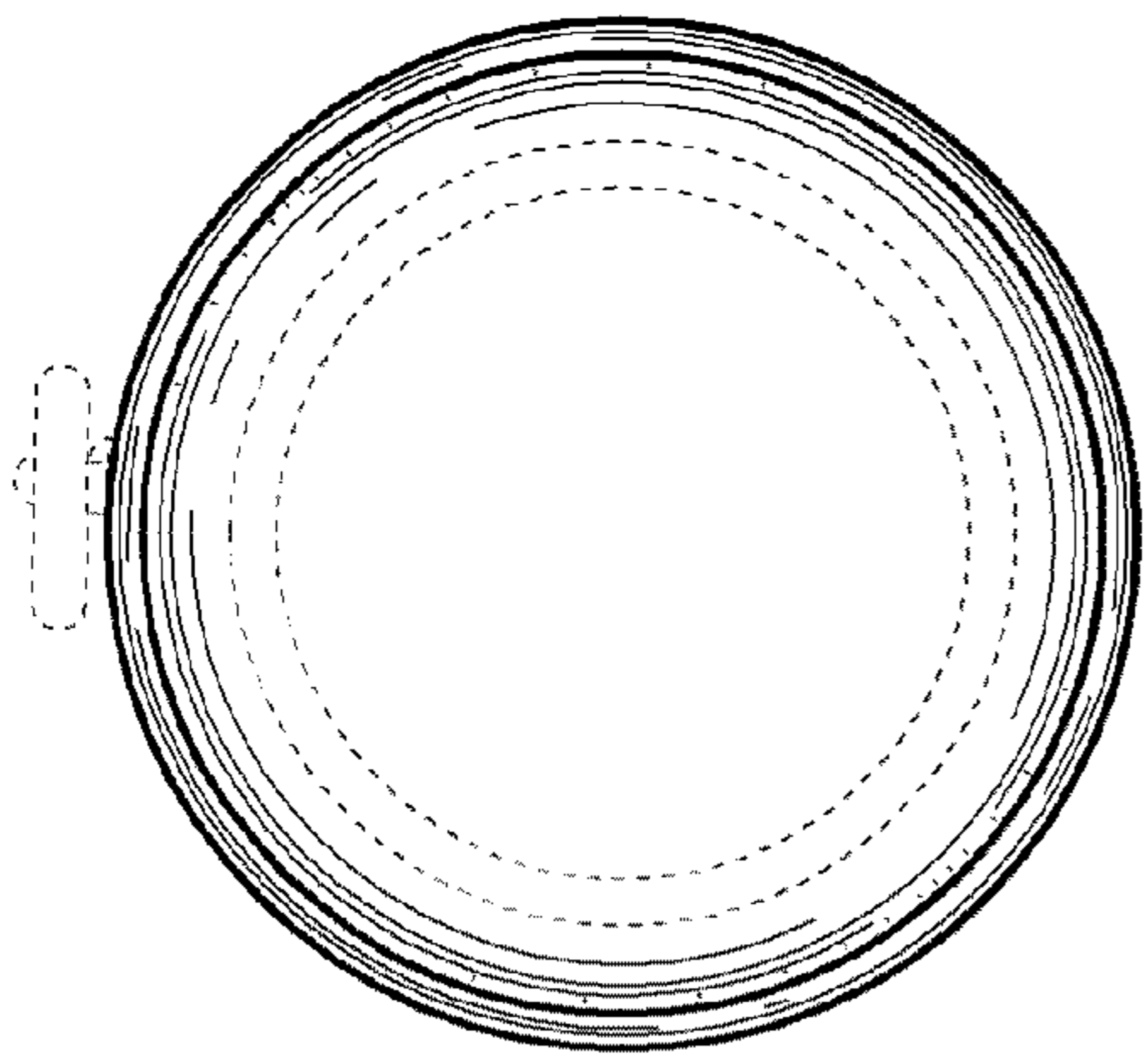

FIG. 7

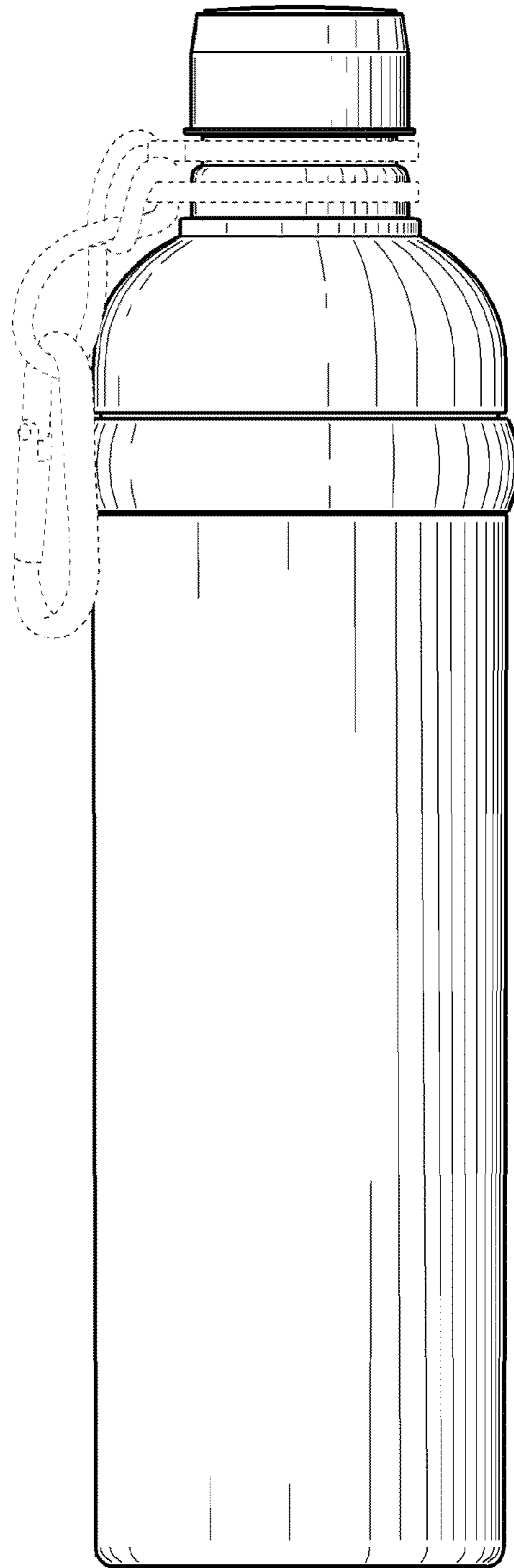

FIG. 8

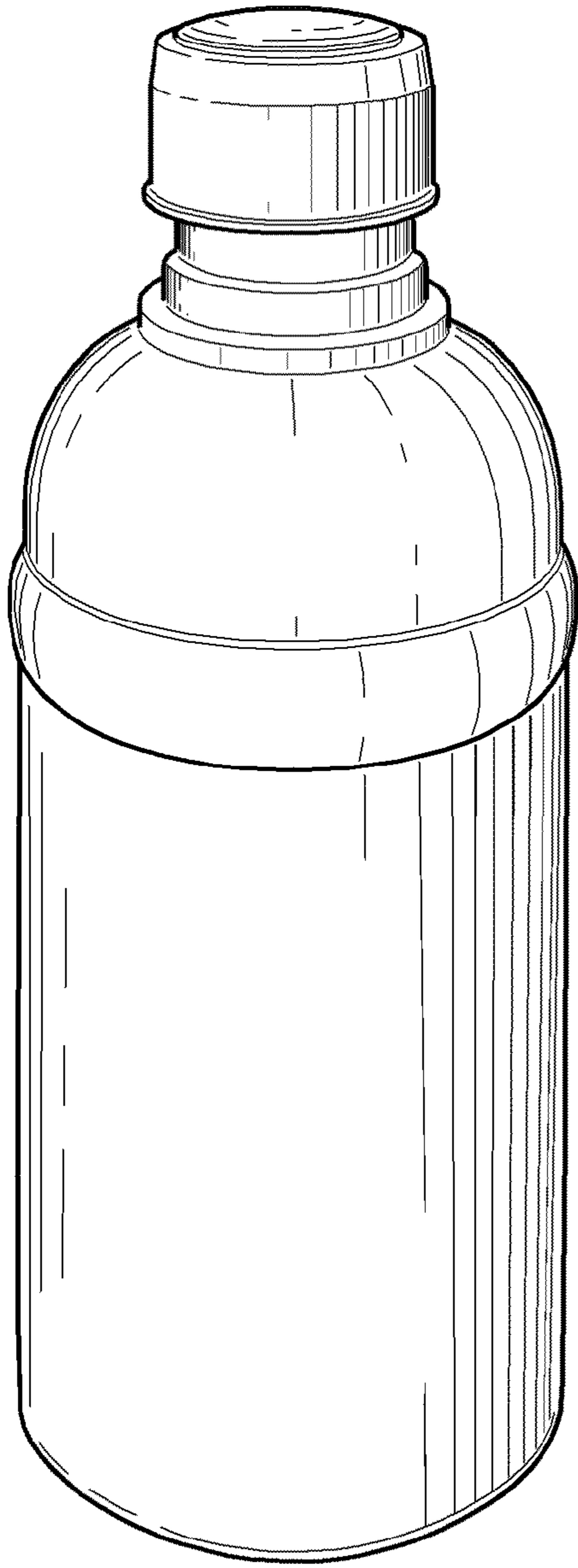

FIG. 9

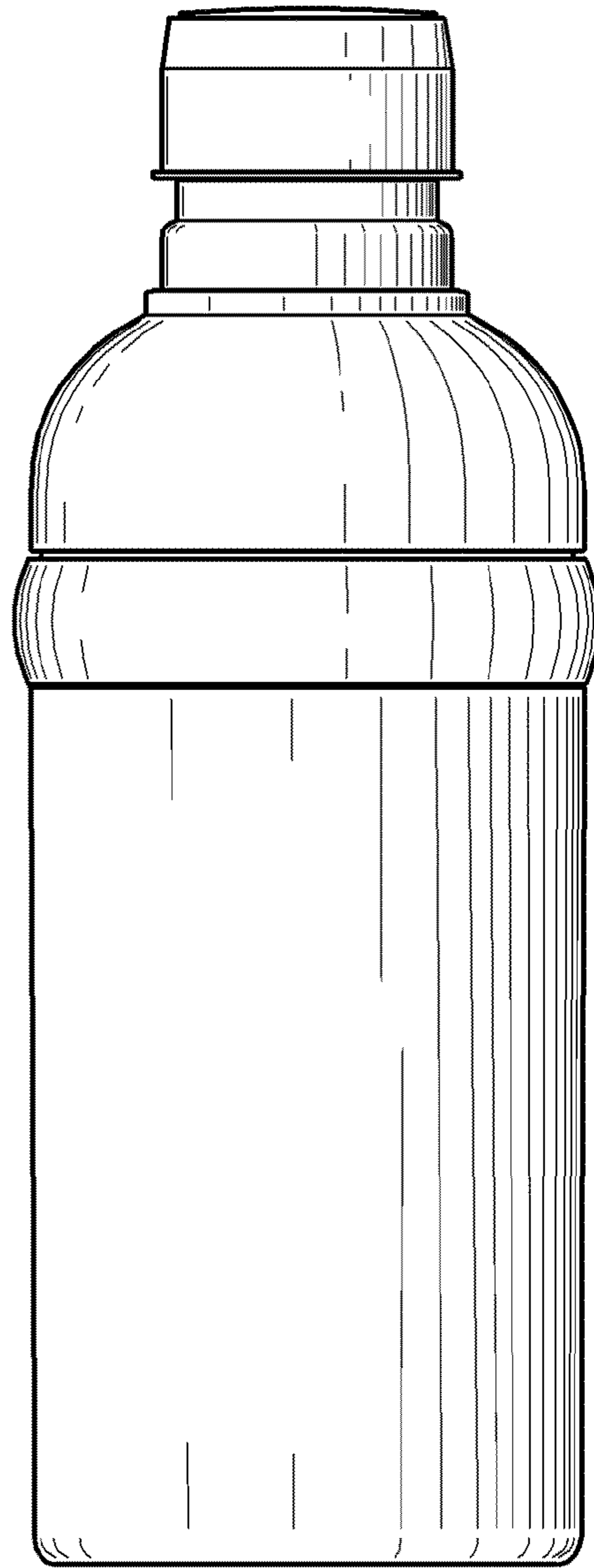

FIG. 10

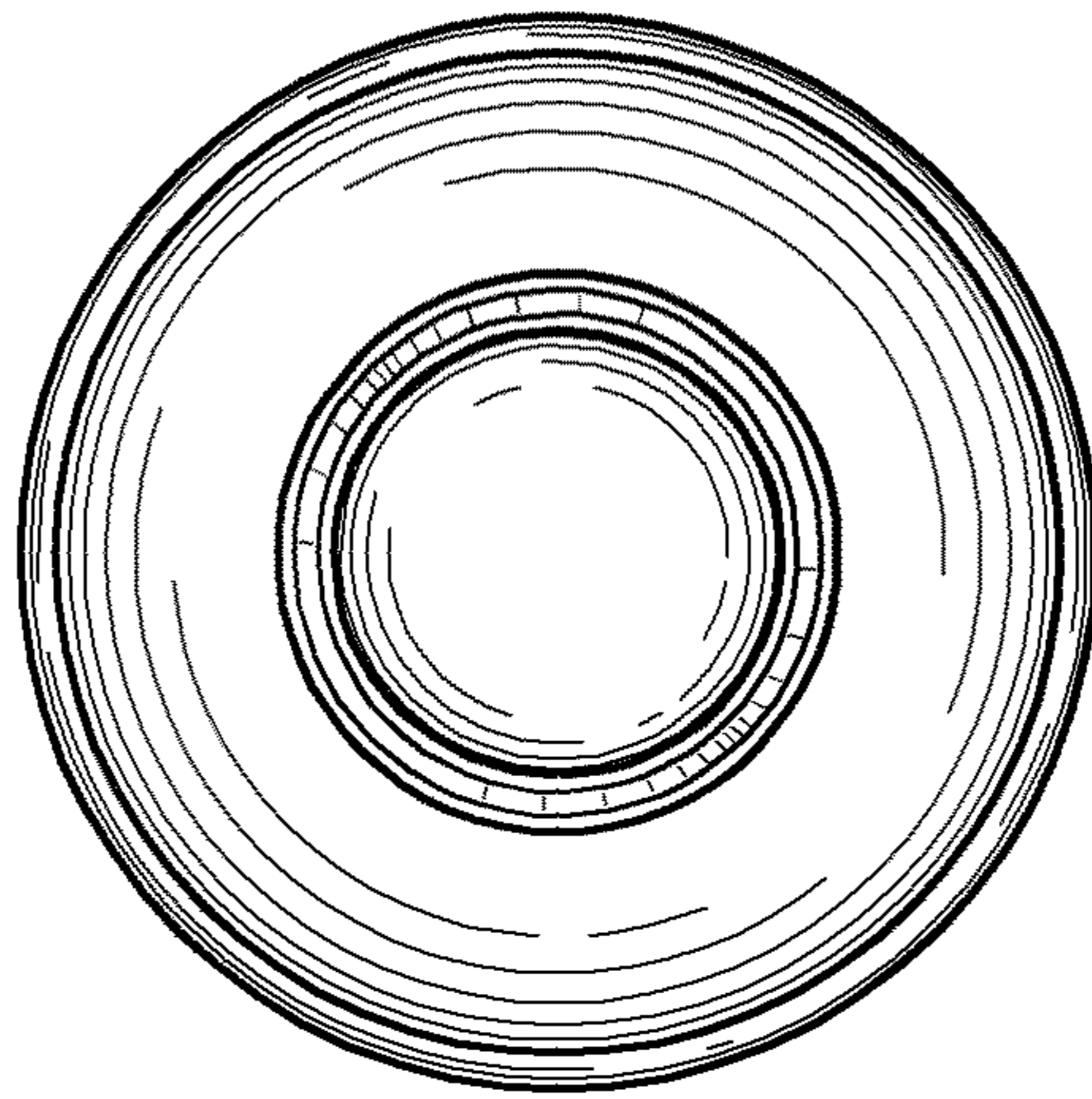

FIG. 11

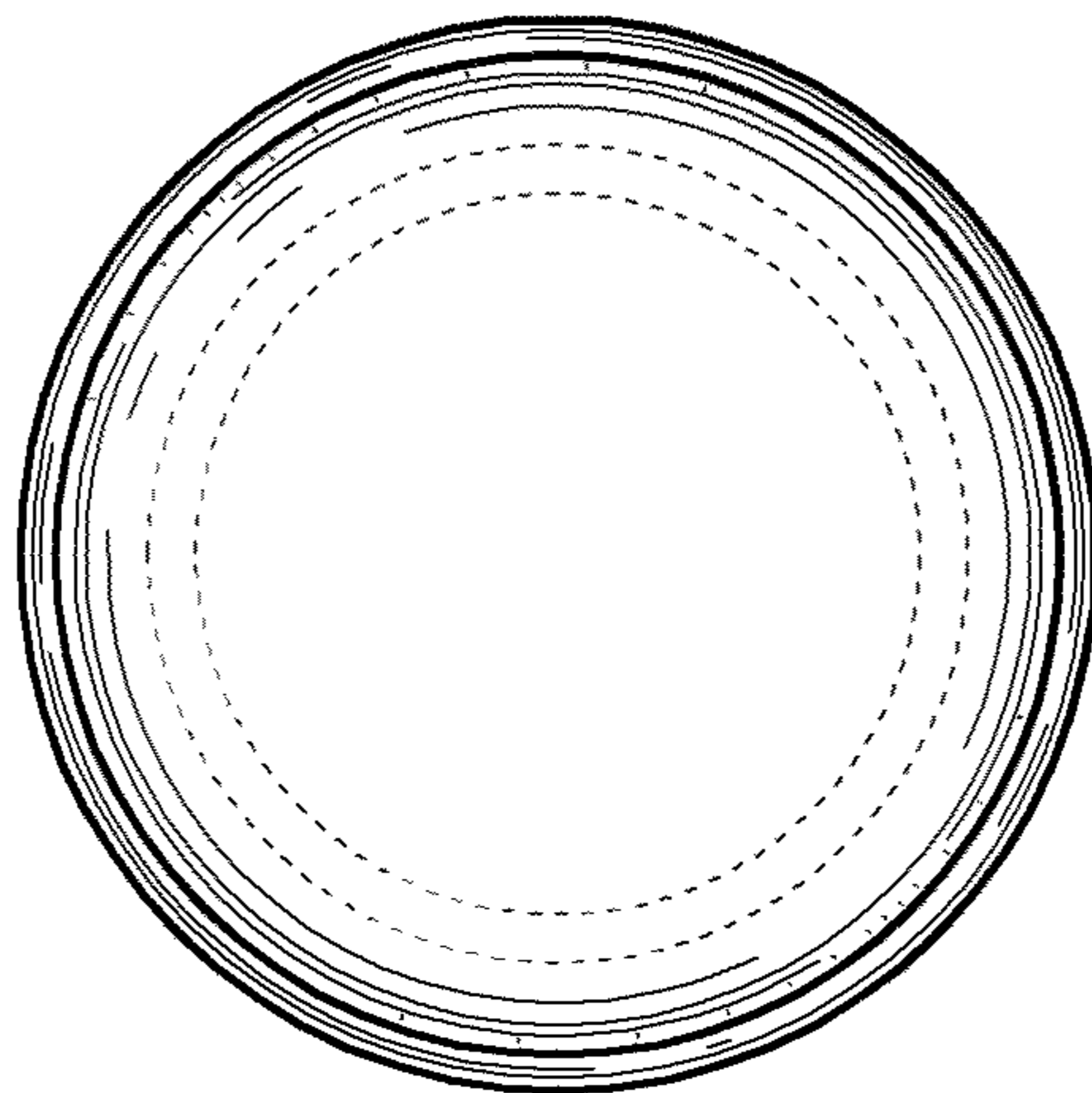

FIG. 12