



US00D689297S

(12) **United States Design Patent**
Su

(10) **Patent No.:** **US D689,297 S**

(45) **Date of Patent:** **** Sep. 10, 2013**

(54) **WHEELED CHAIR**

(71) Applicant: **Chih-Cheng Su**, Dongguan (CN)

(72) Inventor: **Chih-Cheng Su**, Dongguan (CN)

(73) Assignee: **Dongguan Howen Plastic & Metal Products Co., Ltd.**, Dongguan (CN)

(**) Term: **14 Years**

(21) Appl. No.: **29/447,693**

(22) Filed: **Mar. 6, 2013**

(51) **LOC (9) Cl.** **06-01**

(52) **U.S. Cl.**
USPC **D6/376**

(58) **Field of Classification Search**
USPC D6/334–336, 366, 367, 368, 371–374,
D6/376, 379, 380, 716, 716.1, 716.2, 716.3,
D6/716.4; 297/239, 284.7, 445.1, 446.1,
297/448.1, 452.2, 452.29, 452.46, 452.56
See application file for complete search history.

(56) **References Cited**

U.S. PATENT DOCUMENTS

D409,407 S * 5/1999 Wang D6/374
D586,577 S * 2/2009 Koh D6/376
D594,669 S * 6/2009 Asano D6/376

D600,051 S * 9/2009 Parker et al. D6/716.4
D604,535 S * 11/2009 Parker et al. D6/716
D613,084 S * 4/2010 Wilkinson et al. D6/366
D615,784 S * 5/2010 Parker et al. D6/716.4
D638,230 S * 5/2011 Roy D6/366
D638,232 S * 5/2011 Roy D6/376
D645,682 S * 9/2011 Nakamura et al. D6/716.4
8,157,329 B2 * 4/2012 Masoud et al. 297/452.56
D664,785 S * 8/2012 Fletcher et al. D6/376
2012/0306247 A1 * 12/2012 Bisman et al. 297/284.7

* cited by examiner

Primary Examiner — Mimosá De

(57) **CLAIM**

The ornamental design for a wheeled chair, as shown and described.

DESCRIPTION

FIG. 1 is a perspective view of a wheeled chair showing my new design;

FIG. 2 is a front elevational view thereof;

FIG. 3 is a rear elevational view thereof;

FIG. 4 is a left side elevational view thereof;

FIG. 5 is a right side elevational view thereof;

FIG. 6 is a top plan view thereof; and,

FIG. 7 is a bottom plan view thereof.

1 Claim, 7 Drawing Sheets

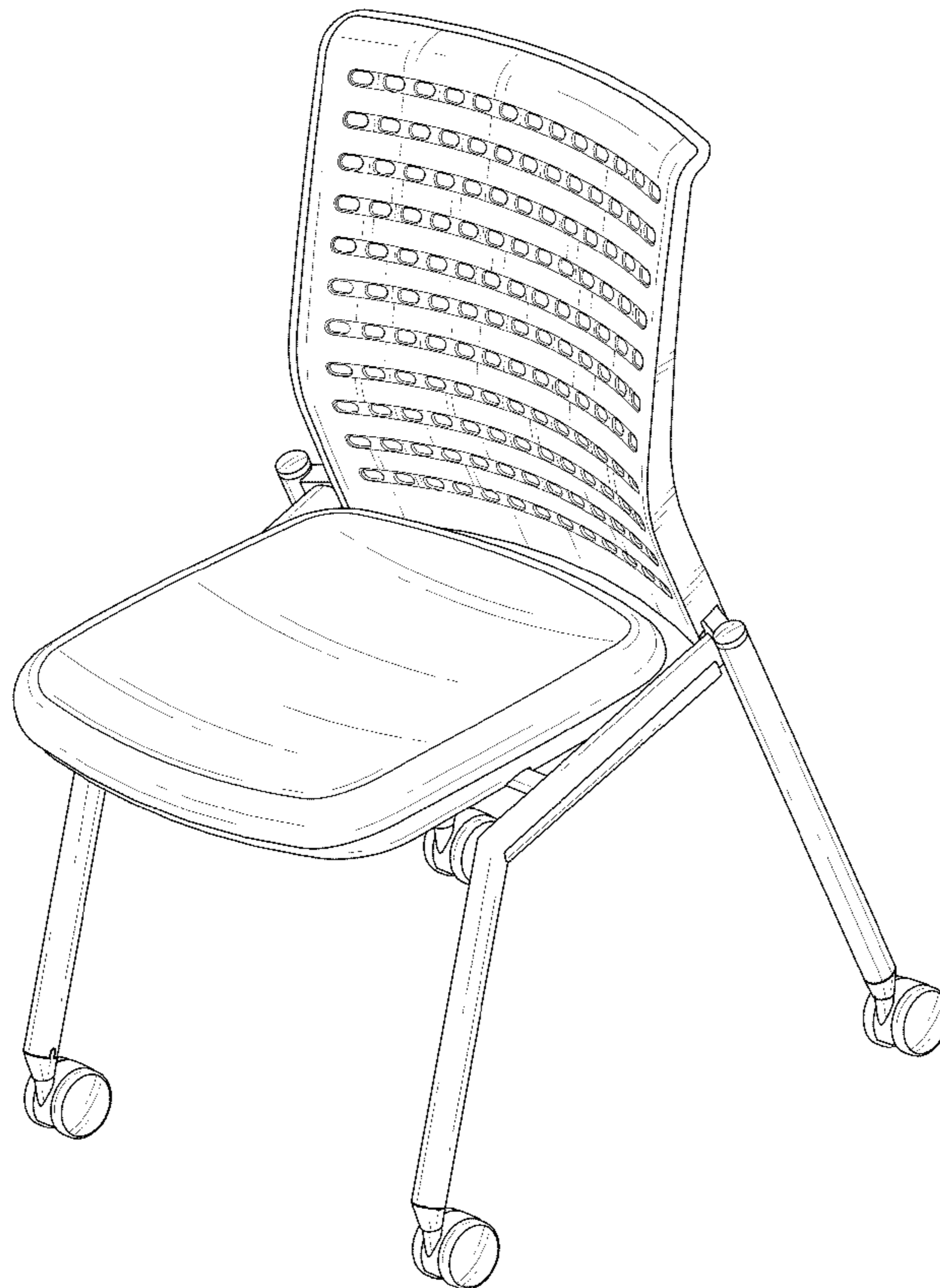

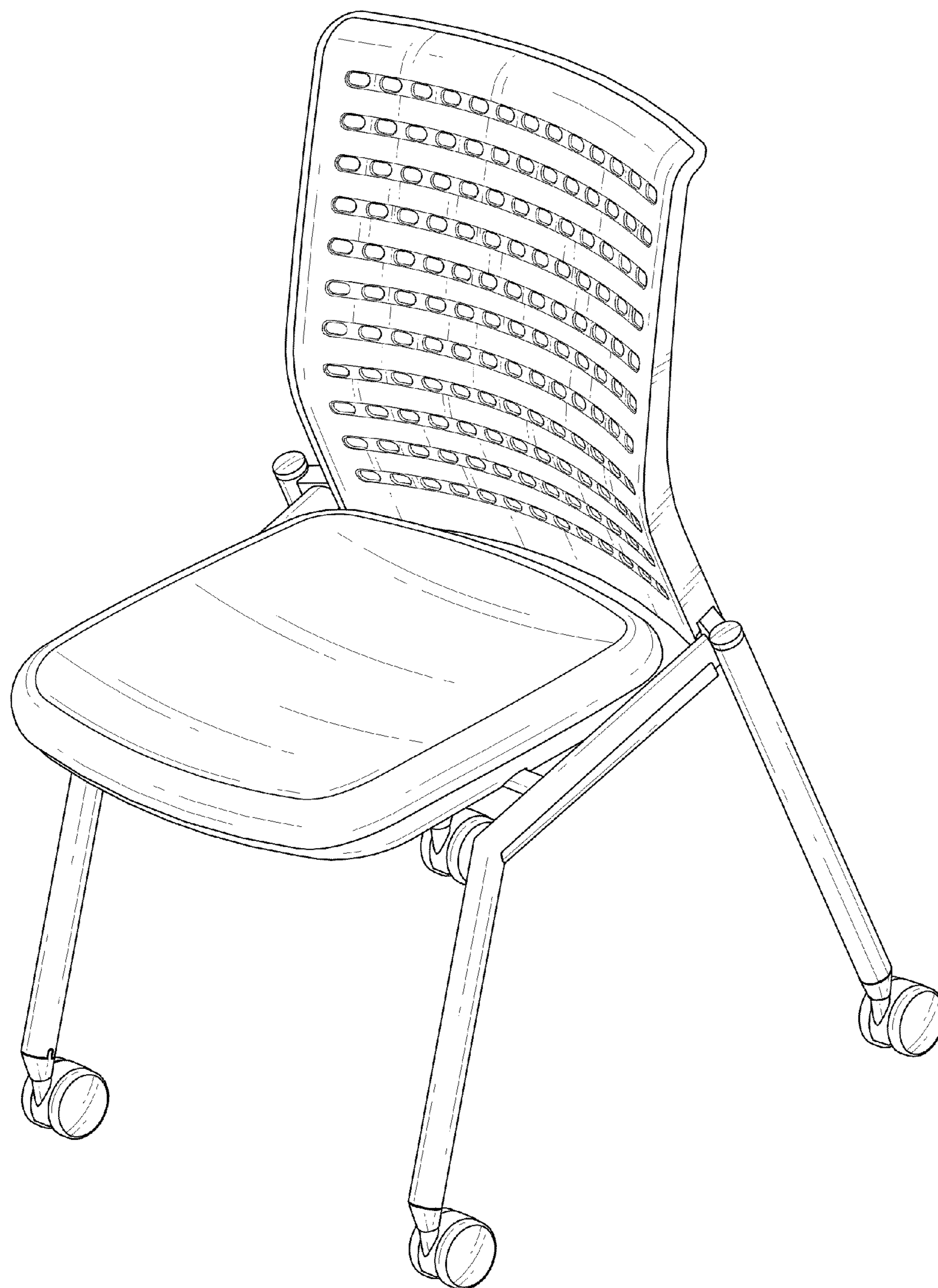

FIG. 1

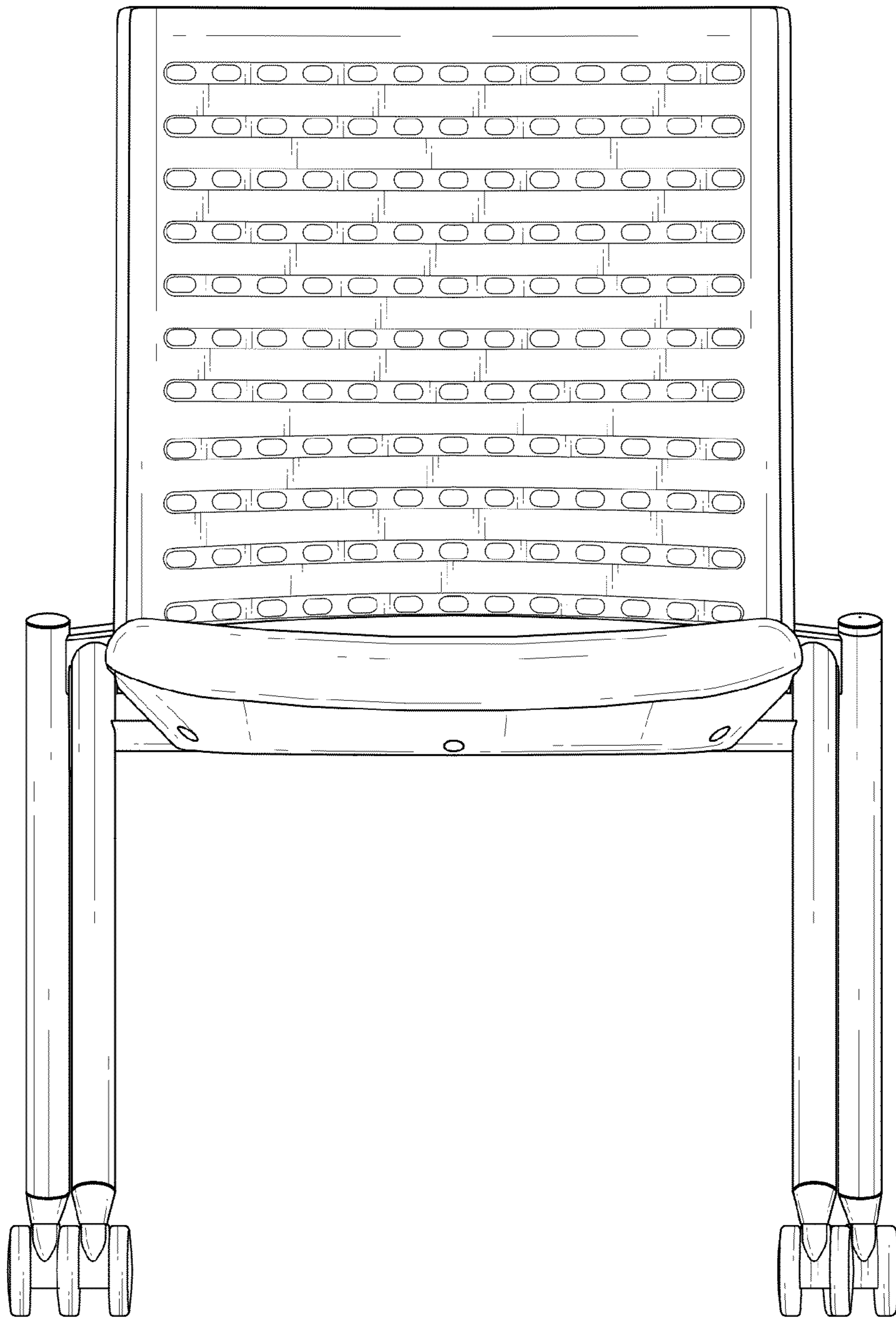

FIG. 2

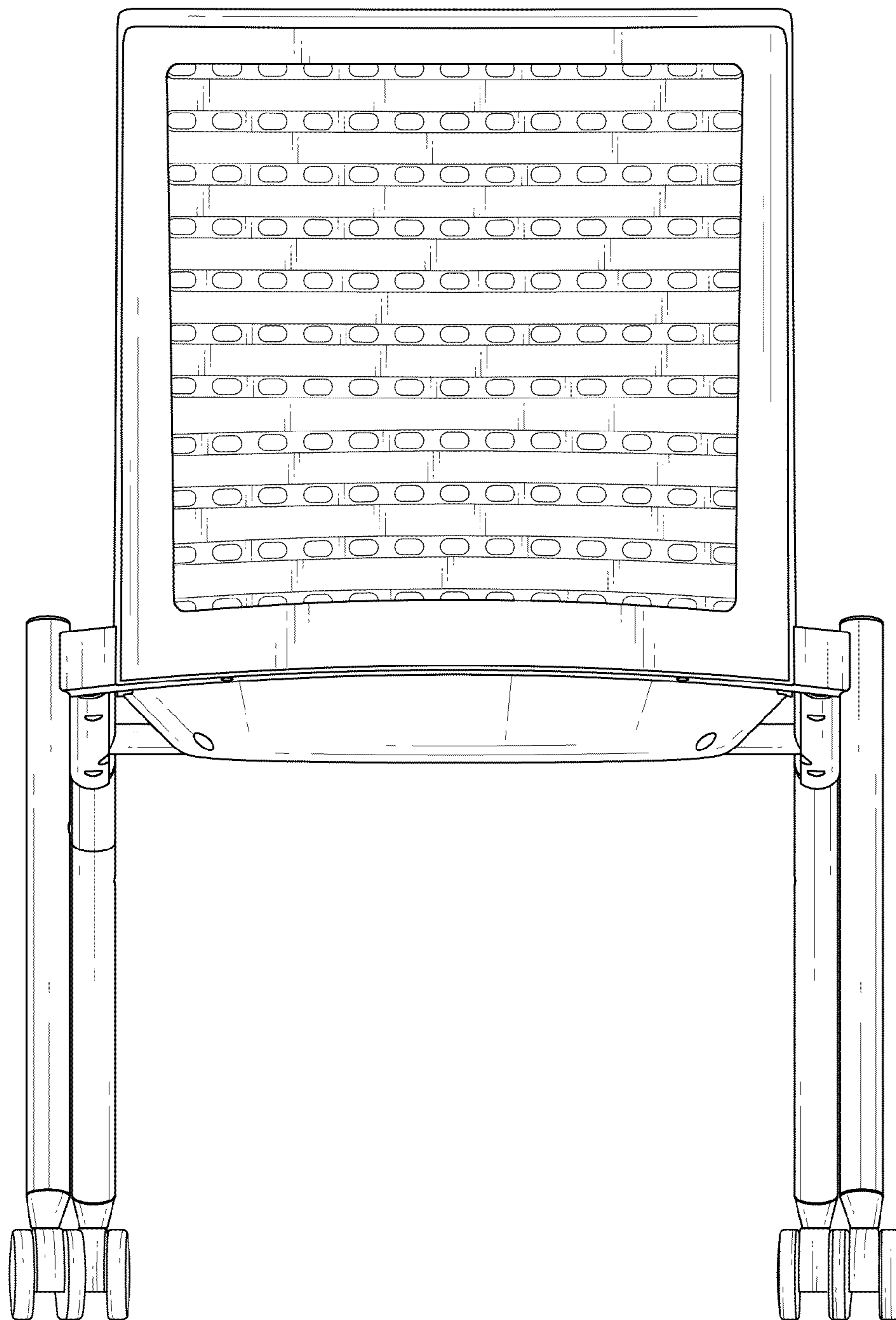

FIG. 3

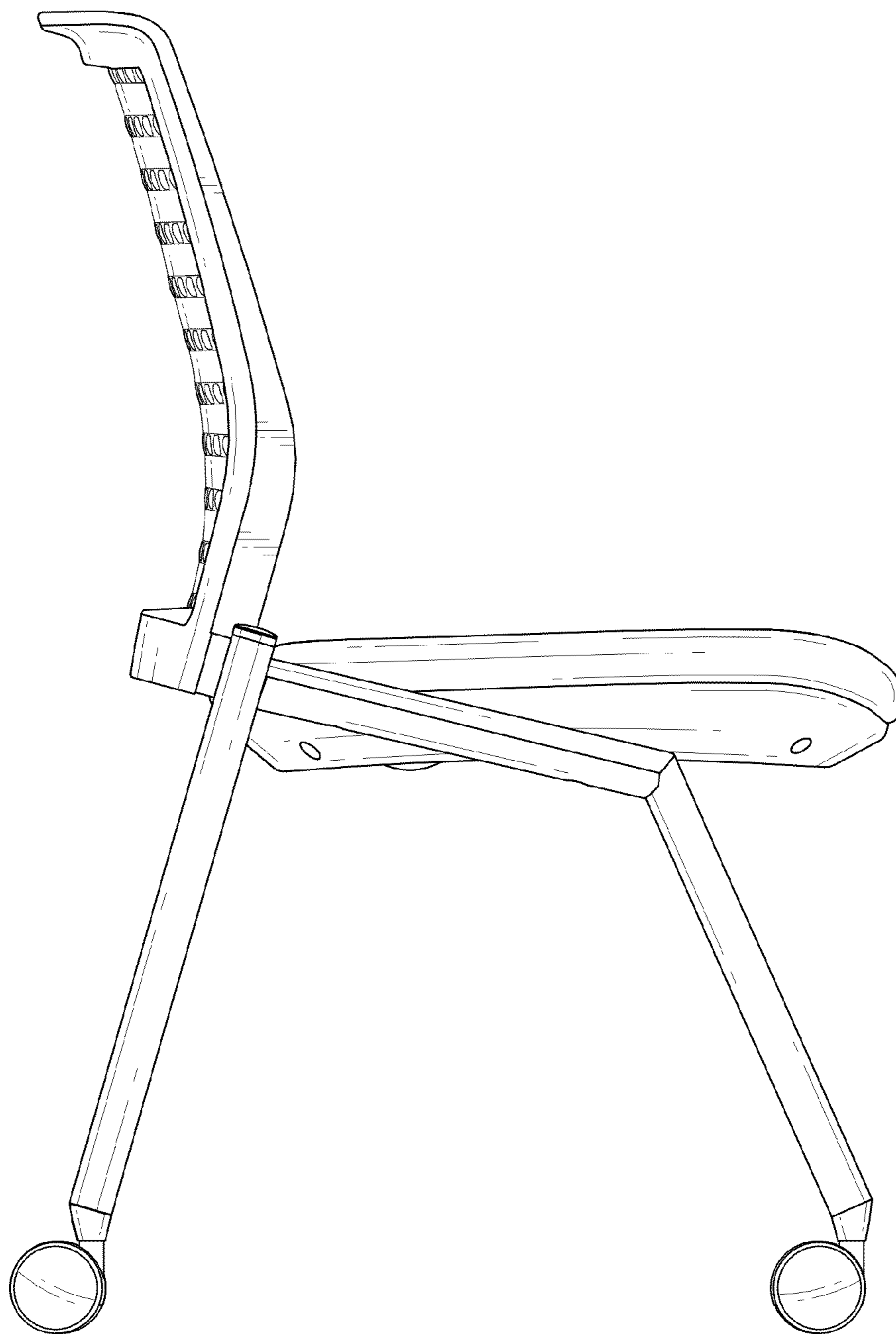

FIG. 4

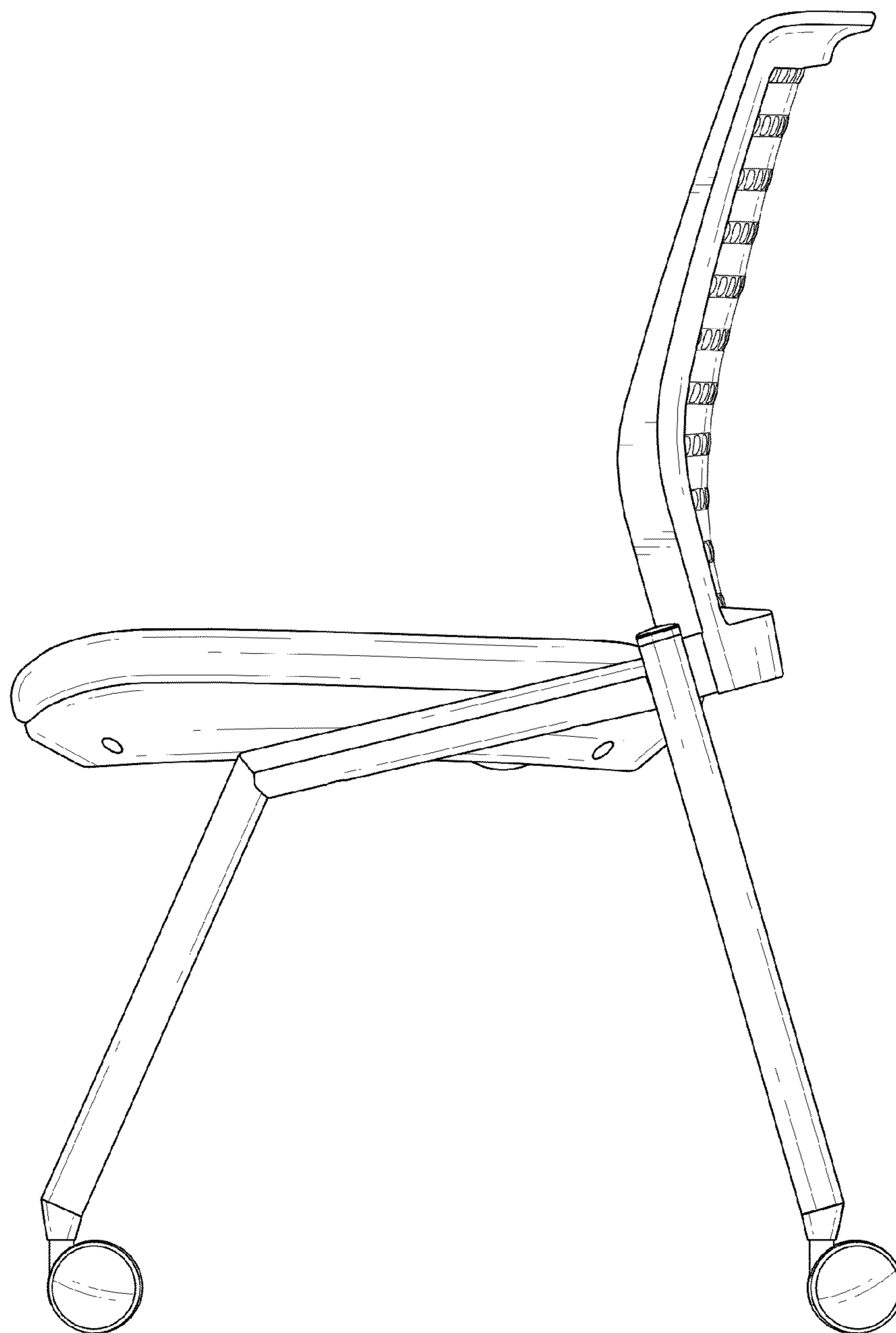

FIG. 5

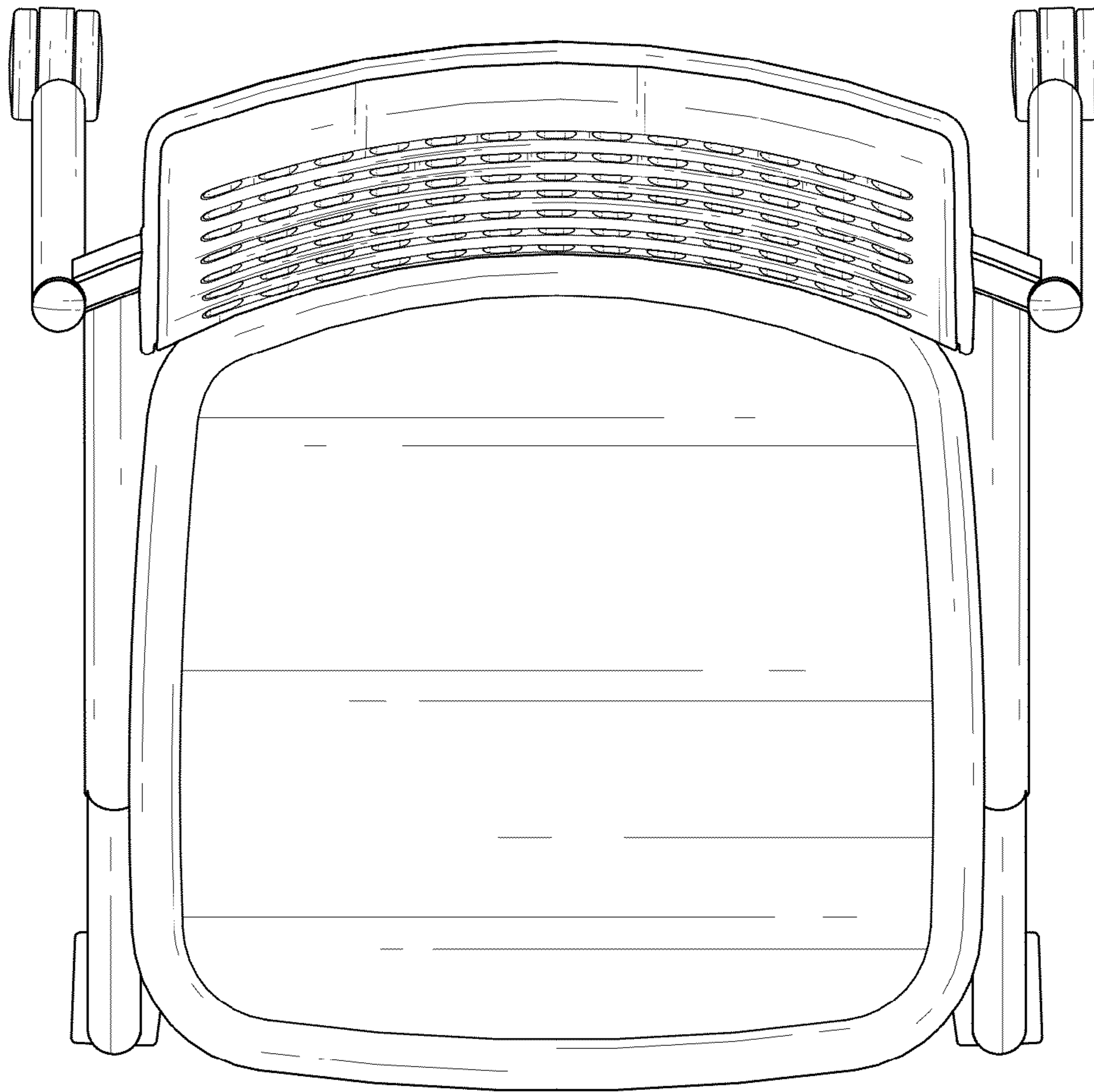

FIG. 6

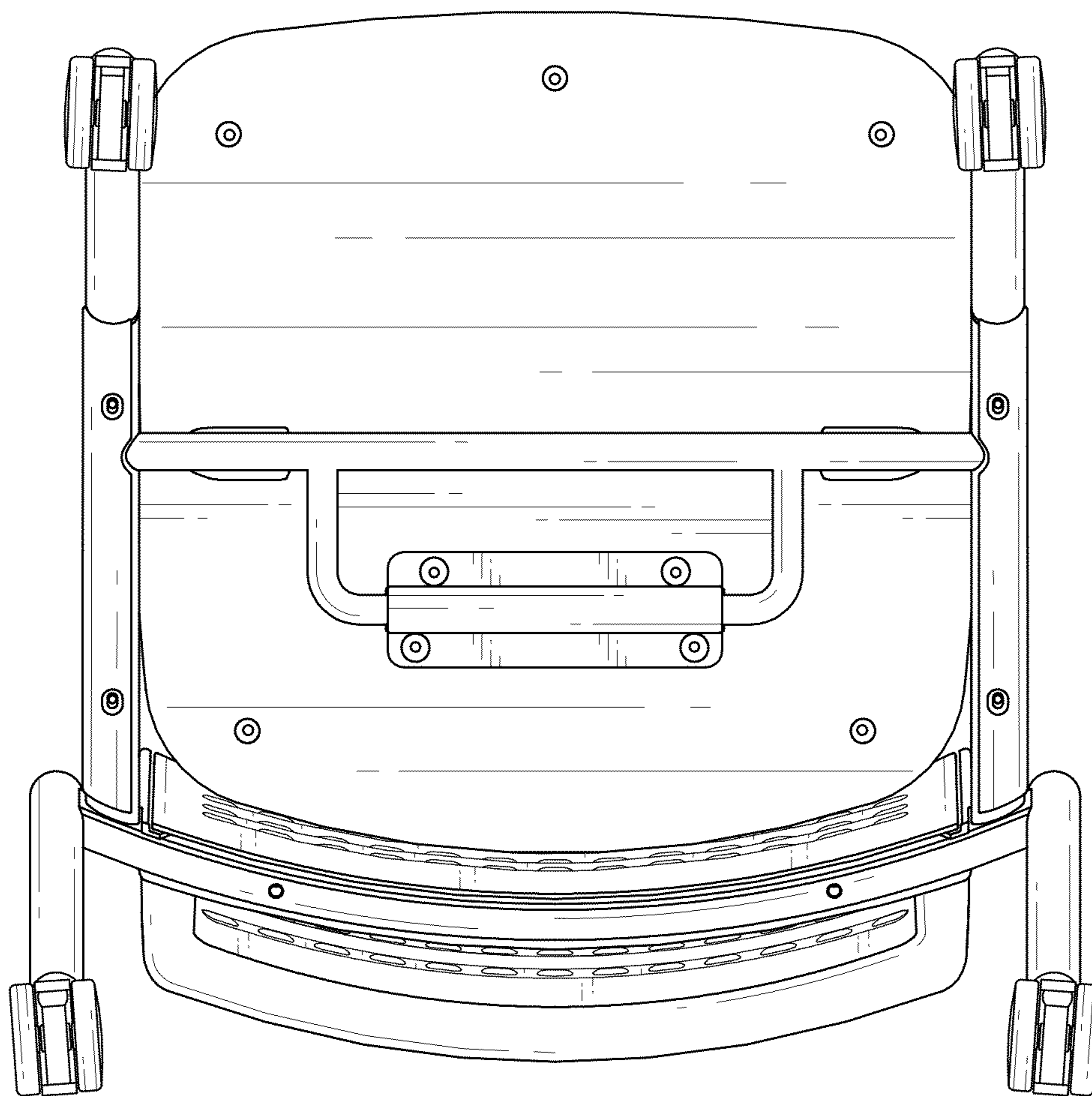

FIG. 7