



US00D689116S

(12) **United States Design Patent**
Chen

(10) **Patent No.:** **US D689,116 S**

(45) **Date of Patent:** **** Sep. 3, 2013**

(54) **EYEGASSES FRAME**

(71) Applicant: **Chih-Ming Chen**, Tainan (TW)

(72) Inventor: **Chih-Ming Chen**, Tainan (TW)

(73) Assignee: **Hwa Meei Optical Co., Ltd.**, Tainan (TW)

(**) Term: **14 Years**

(21) Appl. No.: **29/445,087**

(22) Filed: **Feb. 7, 2013**

(51) **LOC (9) Cl.** **16-06**

(52) **U.S. Cl.**
USPC **D16/311; D16/309; D16/326**

(58) **Field of Classification Search**
USPC D16/101, 300–342, 900; D29/109–110;
351/41, 44, 51–52, 62, 158, 92, 103–123,
351/140–153, 45–46; 2/426–432, 447–449,
2/441, 434–437, 13, 15; D21/483, 659–661;
D14/372

See application file for complete search history.

(56) **References Cited**

U.S. PATENT DOCUMENTS

D423,550	S	*	4/2000	Matera	D16/326
6,233,342	B1	*	5/2001	Fernandez	2/236
6,550,914	B1	*	4/2003	Kopfer	351/62
D484,526	S	*	12/2003	Teng	D16/326
6,692,124	B2	*	2/2004	Katz et al.	351/62
6,749,299	B1	*	6/2004	Hsu	351/62
D524,355	S	*	7/2006	Chuang	D16/326
D535,681	S	*	1/2007	Yang	D16/311

D539,833	S	*	4/2007	Chuang	D16/326
D549,268	S	*	8/2007	Daems et al.	D16/321
D591,789	S	*	5/2009	Li	D16/326
D646,706	S	*	10/2011	Wang	D16/309
2005/0088613	A1	*	4/2005	Jackson et al.	351/154

* cited by examiner

Primary Examiner — Raphael Barkai

(74) *Attorney, Agent, or Firm* — Alan Kamrath; Kamrath IP Lawfirm, P.A.

(57) **CLAIM**

The ornamental design for an eyeglasses frame, as shown and described.

DESCRIPTION

FIG. 1 is a perspective view of an eyeglasses frame showing my design;
 FIG. 2 is a front elevational view thereof;
 FIG. 3 is a rear elevational view thereof;
 FIG. 4 is a left side elevational view thereof, the right side elevational view being a mirror image thereof;
 FIG. 5 is a top plan view thereof;
 FIG. 6 is a bottom plan view thereof;
 FIG. 7 is a perspective view of a first embodiment of the eyeglasses frame; and,
 FIG. 8 is a perspective view of a second embodiment of the eyeglasses frame.
 The broken lines shown in the drawings are included for the purpose of illustrating a portion of the eyeglasses frame that forms no part of the claimed design.

1 Claim, 6 Drawing Sheets

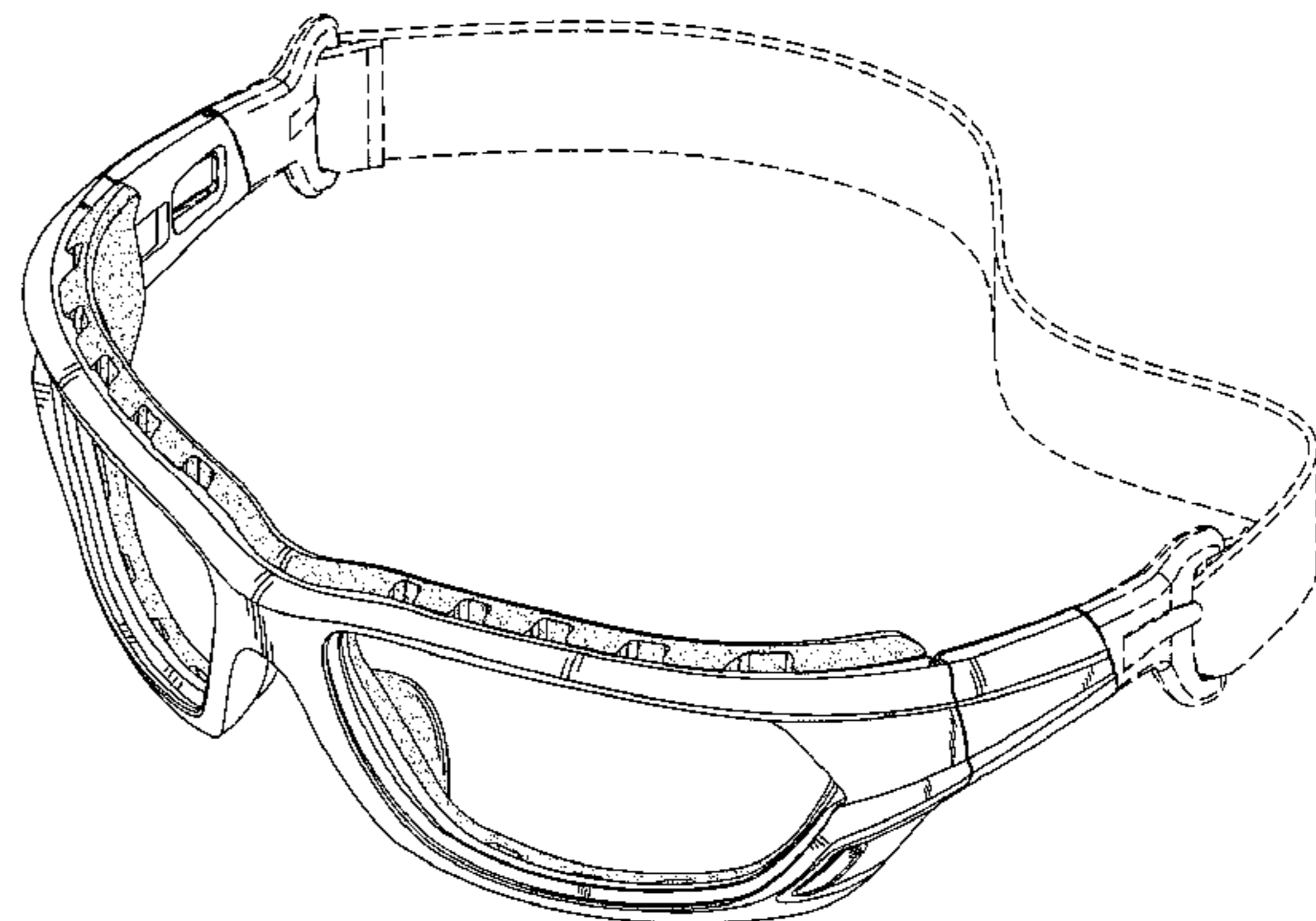
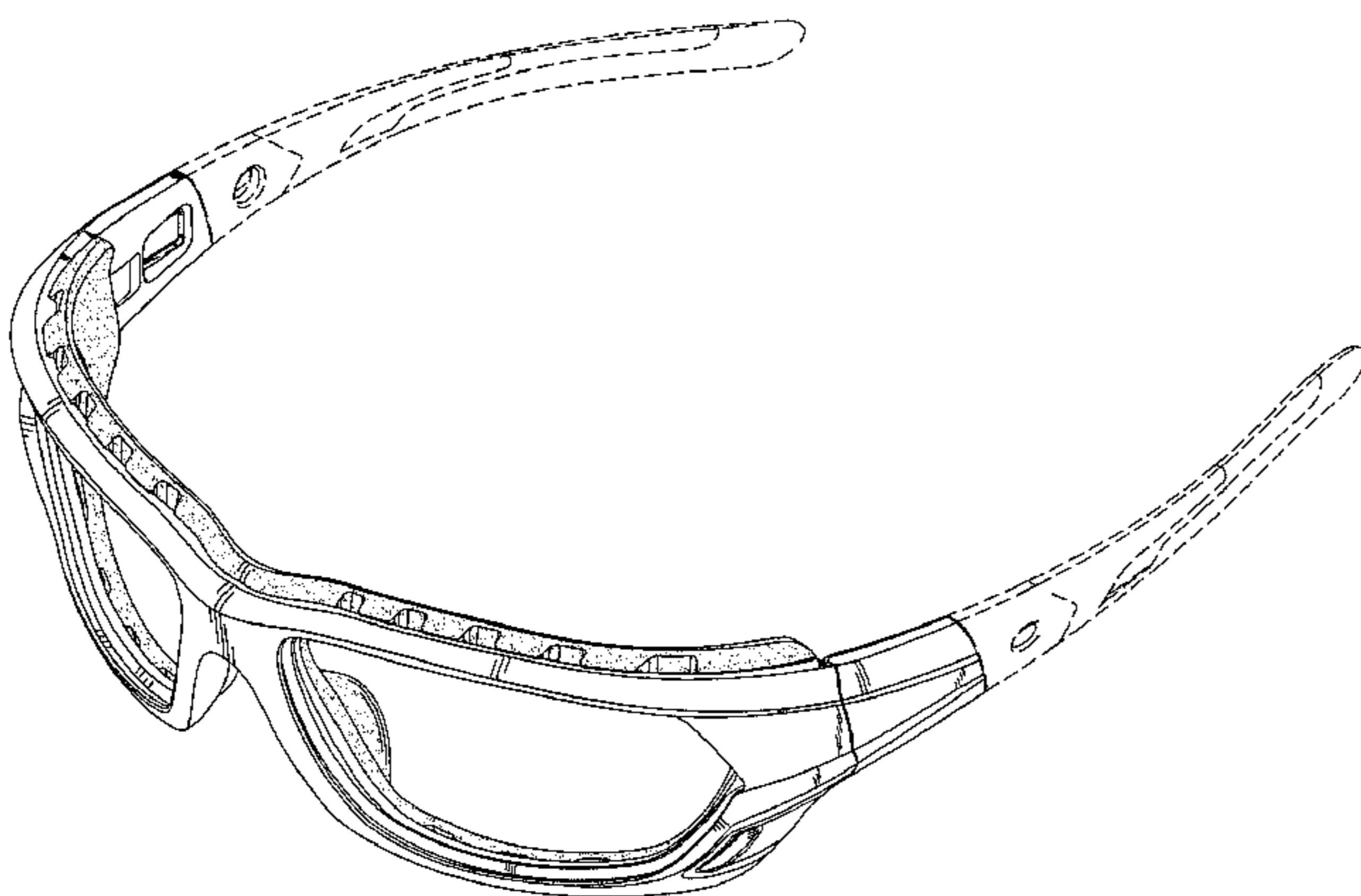

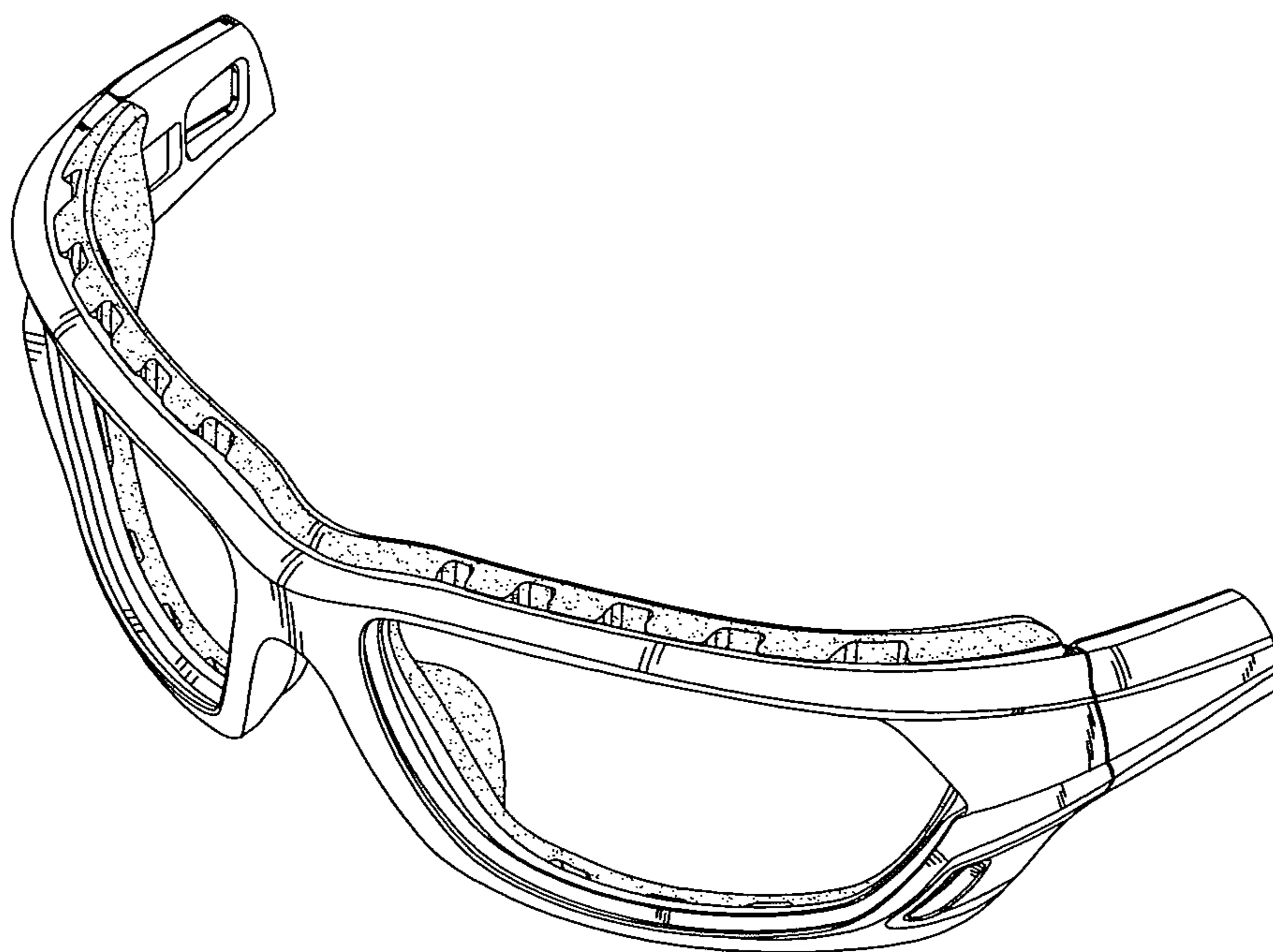

FIG. 1

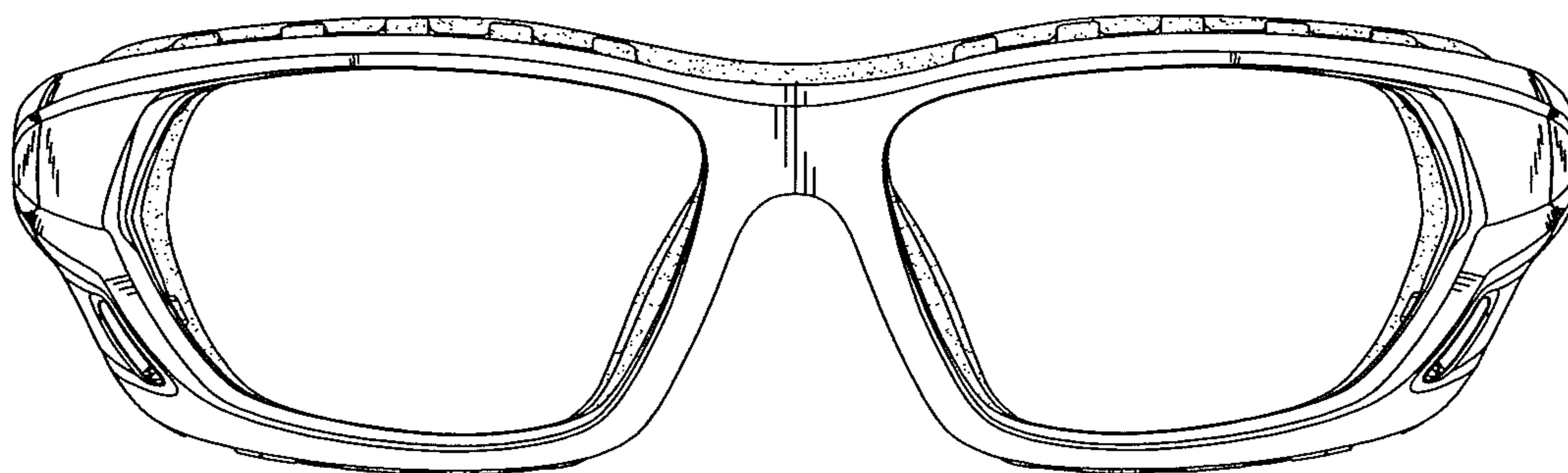

FIG. 2

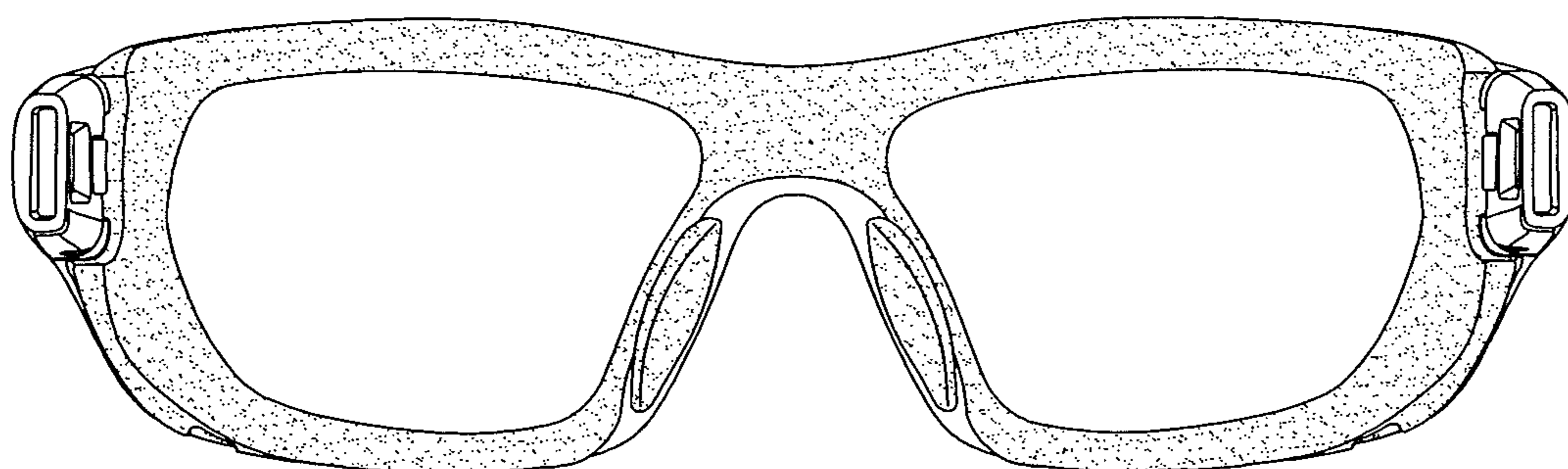

FIG. 3

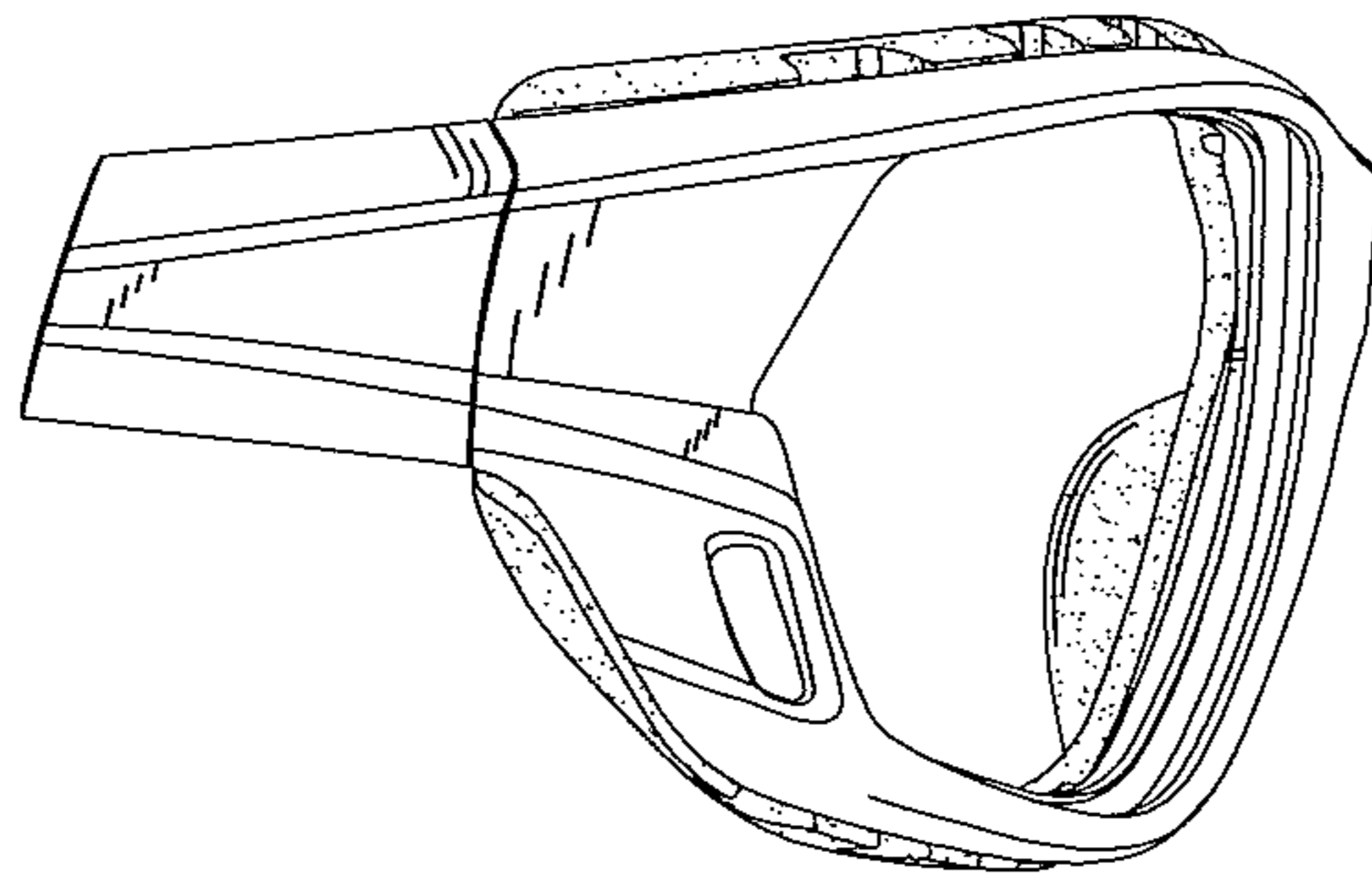

FIG. 4

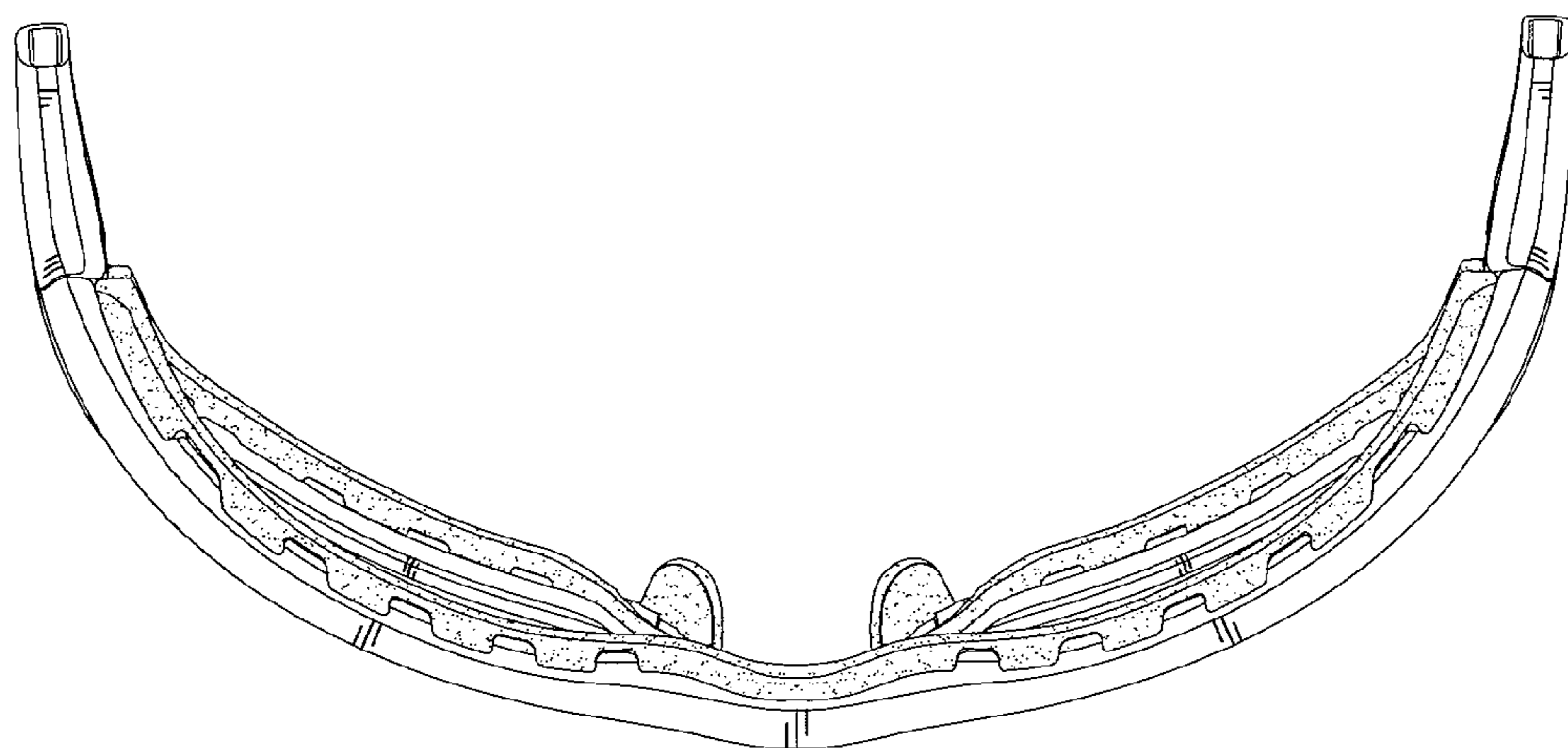

FIG. 5

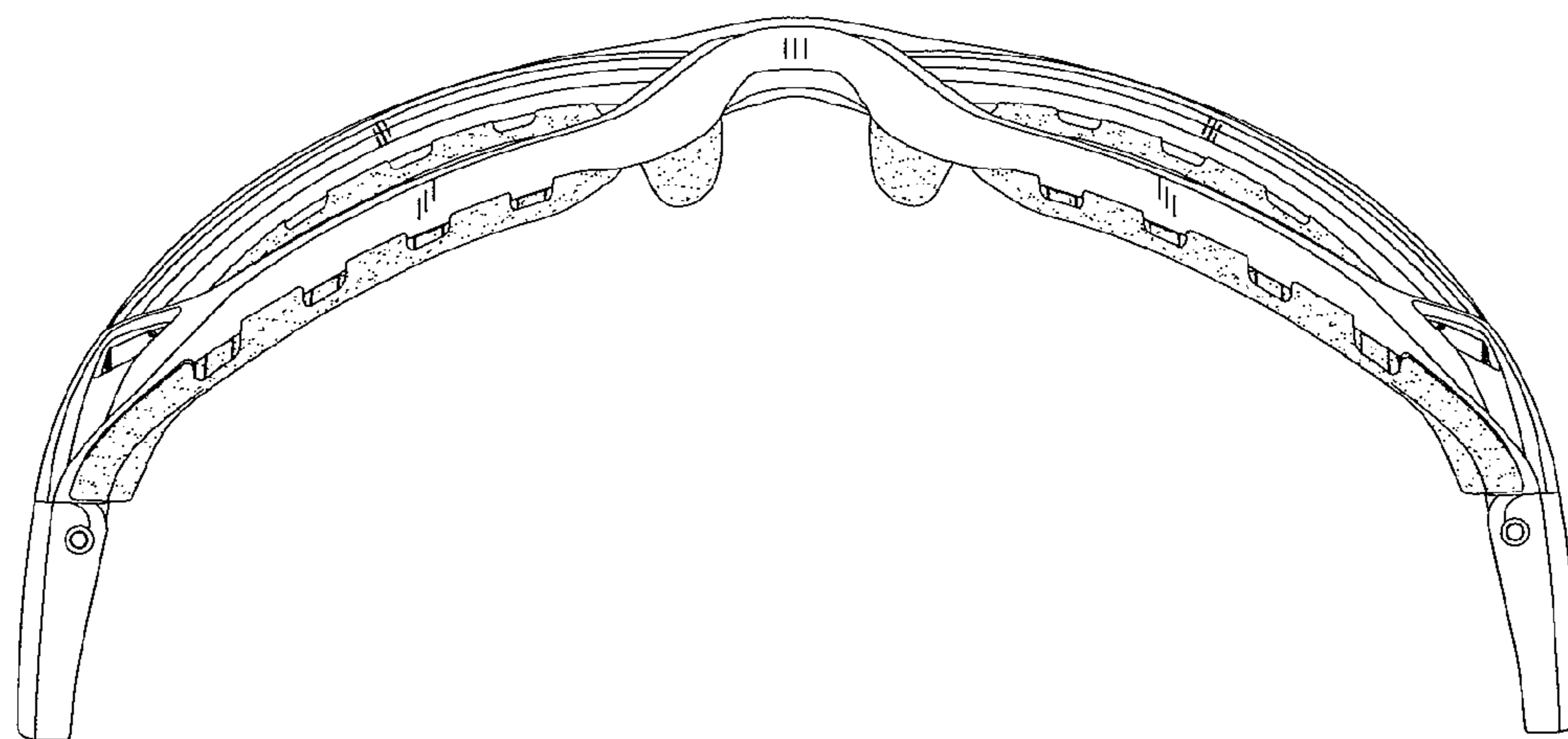

FIG. 6

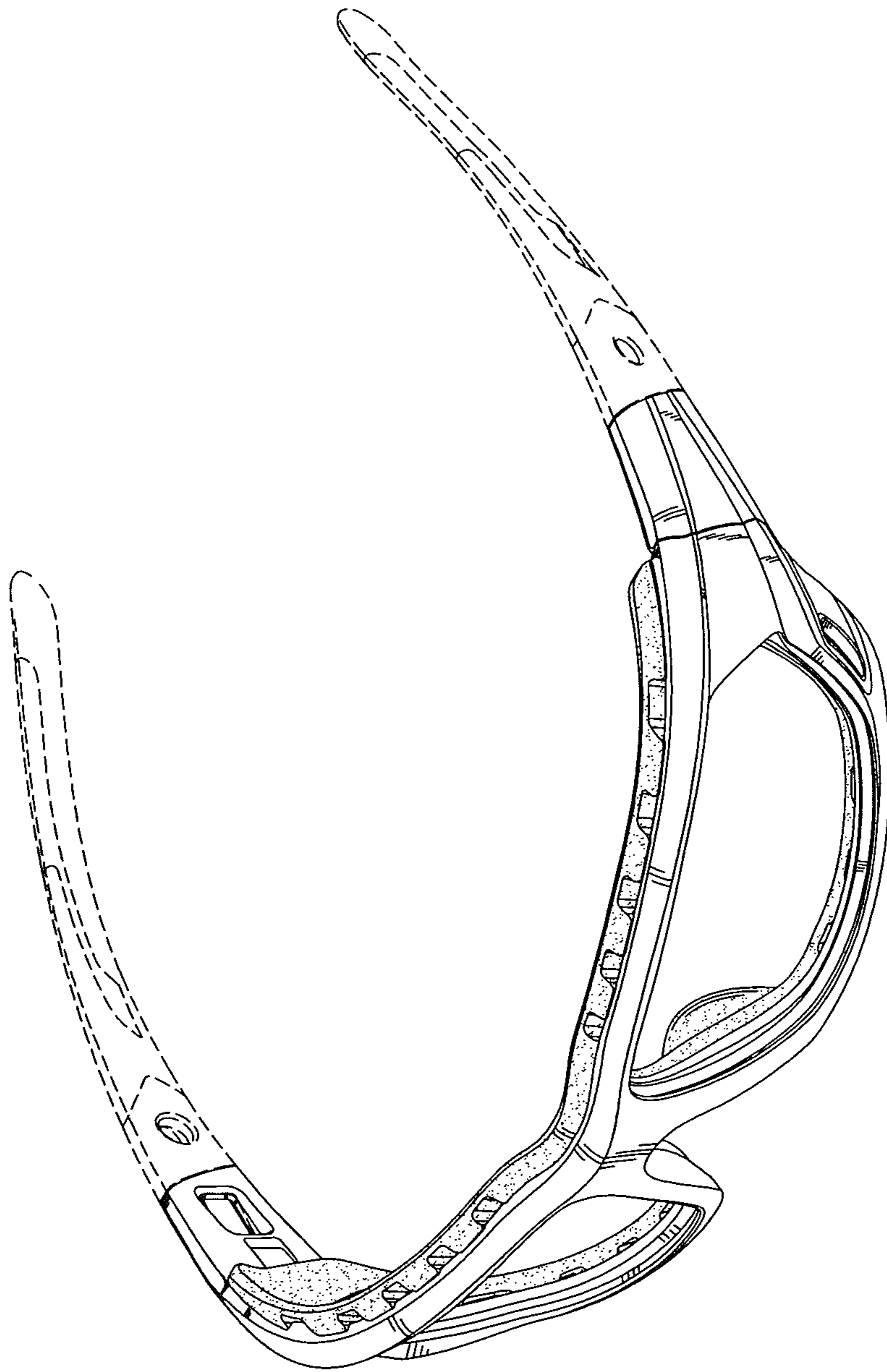

FIG. 7

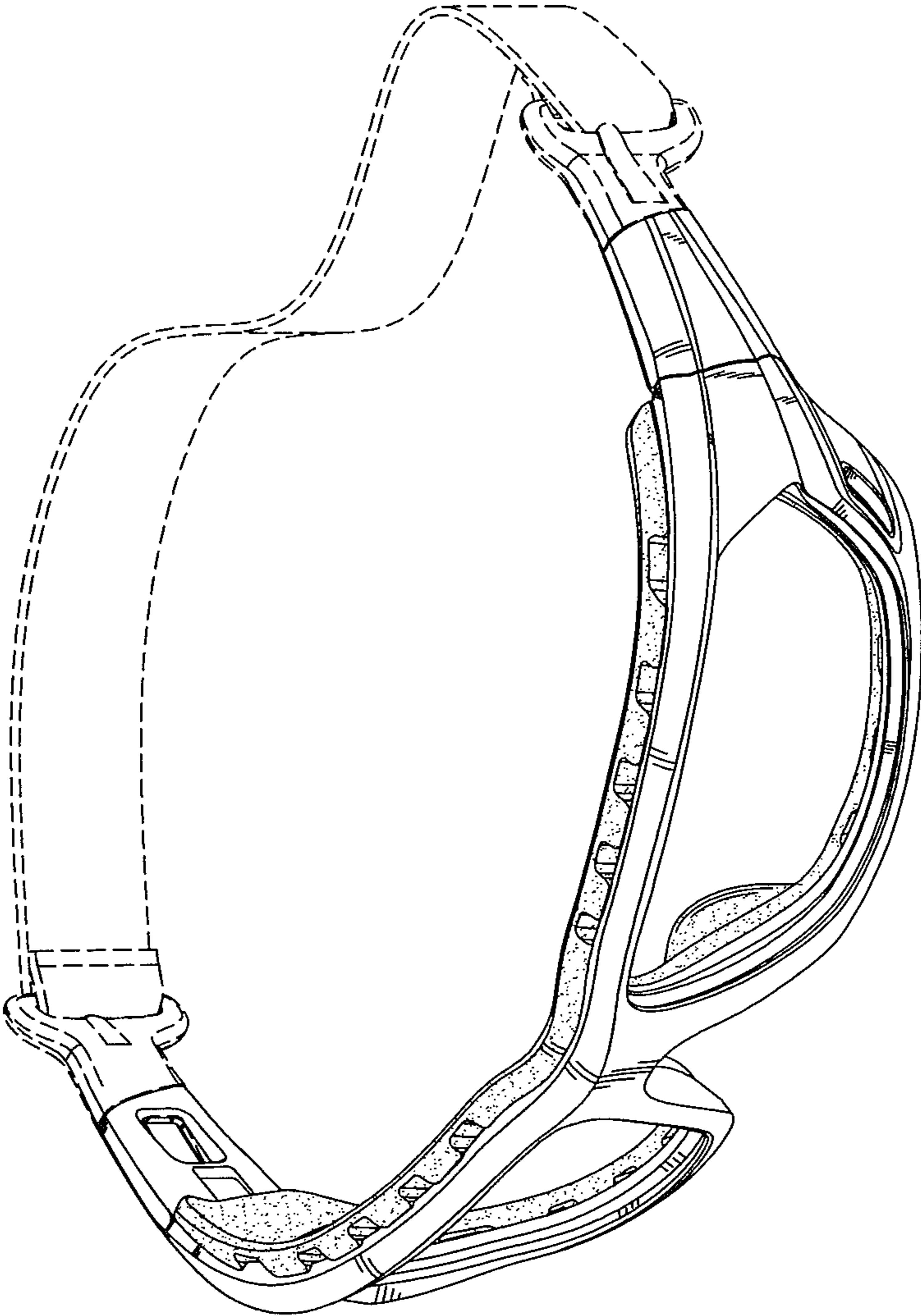

FIG. 8