



US00D689036S

(12) **United States Design Patent**
Yoshida

(10) **Patent No.:** **US D689,036 S**
(45) **Date of Patent:** **** Sep. 3, 2013**

- (54) **TELEPHONE HANDSET**
 - (71) Applicant: **Panasonic Corporation**, Osaka (JP)
 - (72) Inventor: **Tomoya Yoshida**, Fukuoka (JP)
 - (73) Assignee: **Panasonic Corporation**, Osaka (JP)
 - (**) Term: **14 Years**
 - (21) Appl. No.: **29/435,410**
 - (22) Filed: **Oct. 24, 2012**
 - (51) **LOC (9) Cl.** **14-03**
 - (52) **U.S. Cl.**
USPC **D14/147**
 - (58) **Field of Classification Search**
USPC D14/138 G, 138 AD, 341, 346, 138 R,
D14/138 AC, 496, 203.1, 203.4, 203.7, 248,
D14/218; 455/575.1, 556.2, 575.3, 575.4;
D21/517; 379/433.01, 433.04; D10/65,
D10/78, 104; D13/168
- See application file for complete search history.

- D668,630 S * 10/2012 Sakamoto D14/147
- D669,449 S * 10/2012 Sakamoto D14/147
- D669,878 S * 10/2012 Furuno et al. D14/147
- D670,674 S * 11/2012 Chou et al. D14/148
- D671,516 S * 11/2012 Ookawa et al. D14/148
- D671,517 S * 11/2012 Katori D14/148
- D677,238 S * 3/2013 Shioya D14/147

OTHER PUBLICATIONS

Link2Cell Technology for Panasonic Telephones, posted Mar. 18, 2013, [online], [site visited Jun. 17, 2013]. Available from Internet, <URL: http://www.youtube.com/watch?v=ppSO5wXp_84>.*

* cited by examiner

Primary Examiner — Jeffrey D Asch

(74) *Attorney, Agent, or Firm* — Panasonic Patent Center

(57) **CLAIM**

The ornamental design for a telephone handset, as shown and described.

DESCRIPTION

FIG. 1 is a perspective view of a telephone handset of the present invention;
FIG. 2 is a front view thereof;
FIG. 3 is a first side view thereof;
FIG. 4 is a second side view thereof;
FIG. 5 is a top view thereof;
FIG. 6 is a rear view thereof; and,
FIG. 7 is a bottom view thereof.

The broken lines shown in the figures that are immediately adjacent to the shaded areas and define regions that are consistently unshaded, represent the bounds of the claim, while all other broken lines, including those beneath the transparent panel on the front, are directed to environment and are for illustrative purposes only; the broken lines form no part of the claimed design.

1 Claim, 7 Drawing Sheets

(56) **References Cited**

U.S. PATENT DOCUMENTS

- D370,223 S * 5/1996 Kajita et al. D14/138 AA
- D412,169 S * 7/1999 Schnell et al. D14/138 AA
- D443,600 S * 6/2001 Ogawa D14/138 AA
- D574,355 S * 8/2008 Okawa et al. D14/147
- D583,349 S * 12/2008 Lee et al. D14/138 AA
- D583,354 S * 12/2008 Gonser et al. D14/147
- D584,297 S * 1/2009 Furuno et al. D14/247
- D586,326 S * 2/2009 Hwang D14/147
- D617,761 S * 6/2010 Wang D14/138 AA
- D618,657 S 6/2010 Sakamoto
- D618,658 S * 6/2010 Sakamoto et al. D14/147
- D620,915 S * 8/2010 Brabander D14/147
- D644,198 S * 8/2011 Brabander D14/147
- D647,516 S * 10/2011 Brabander D14/248
- D654,451 S * 2/2012 Jeon et al. D14/138 AA

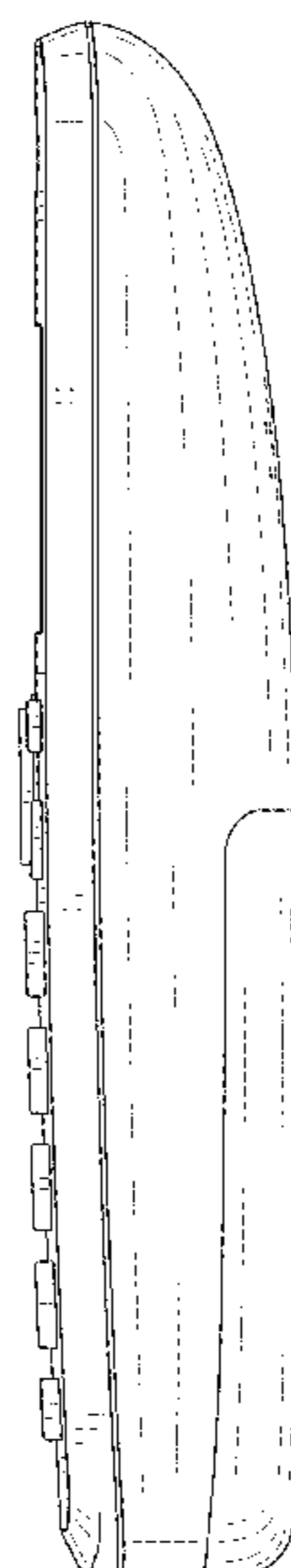
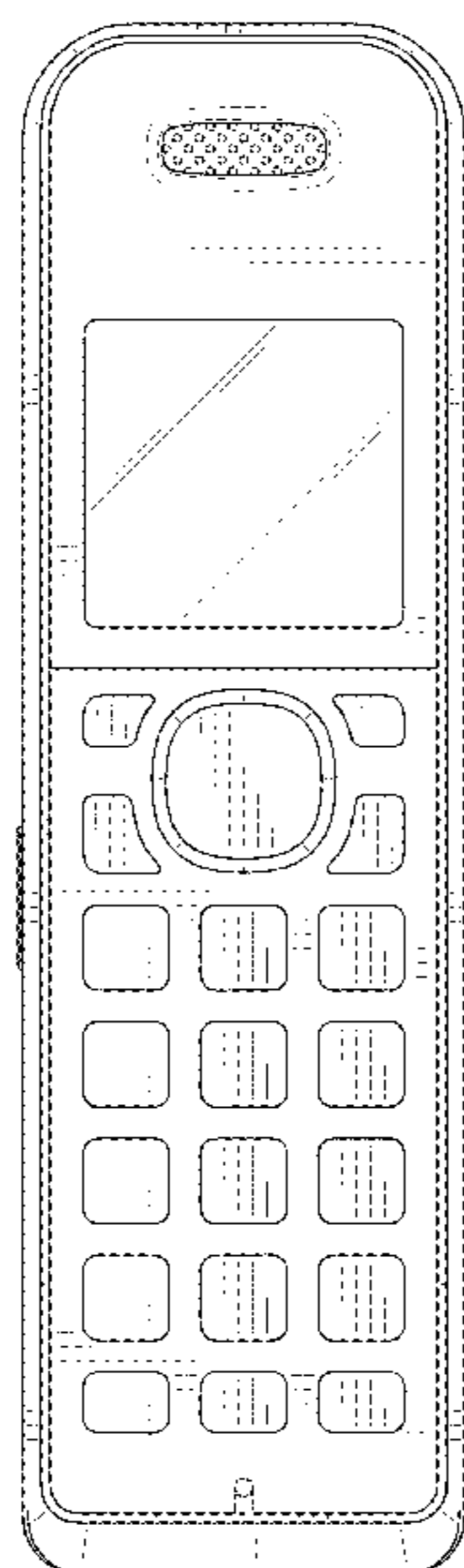

FIG. 1

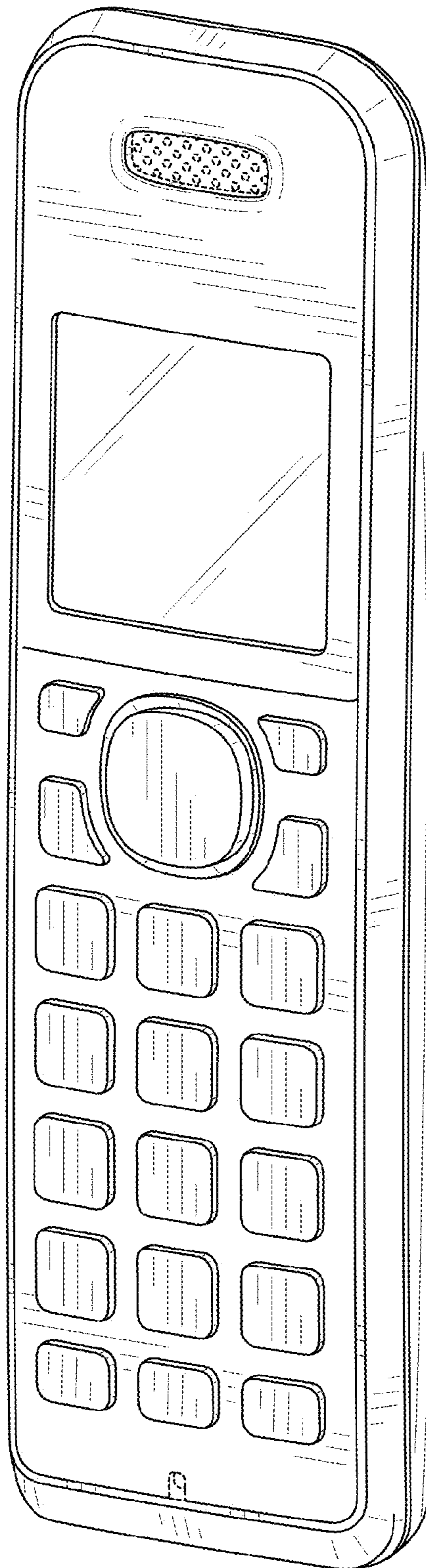

FIG. 2

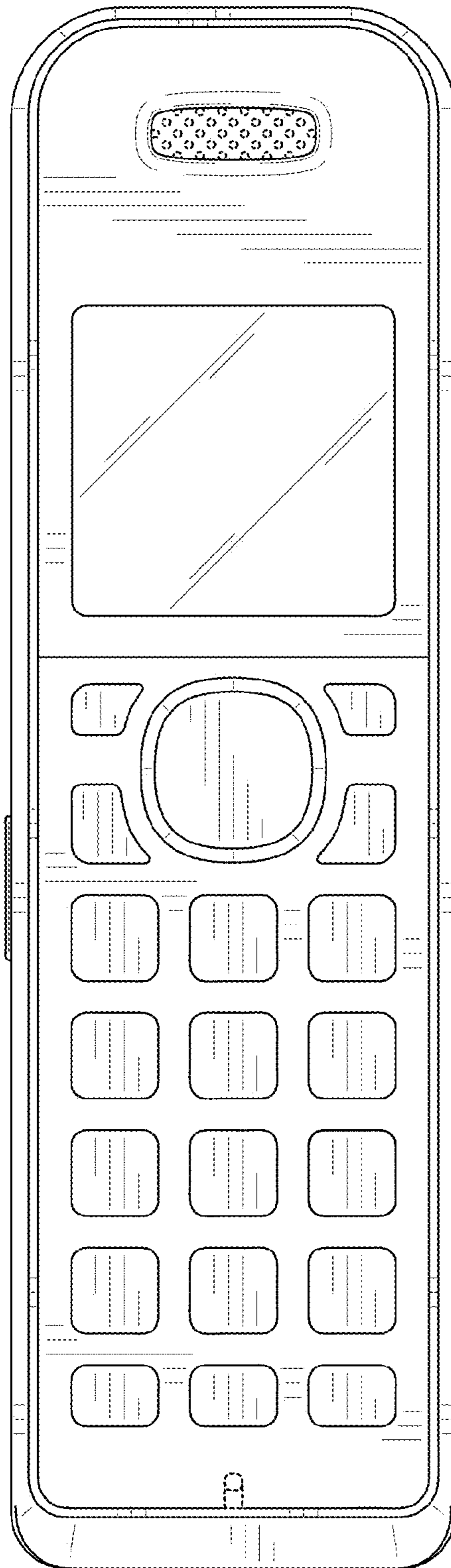

FIG. 3

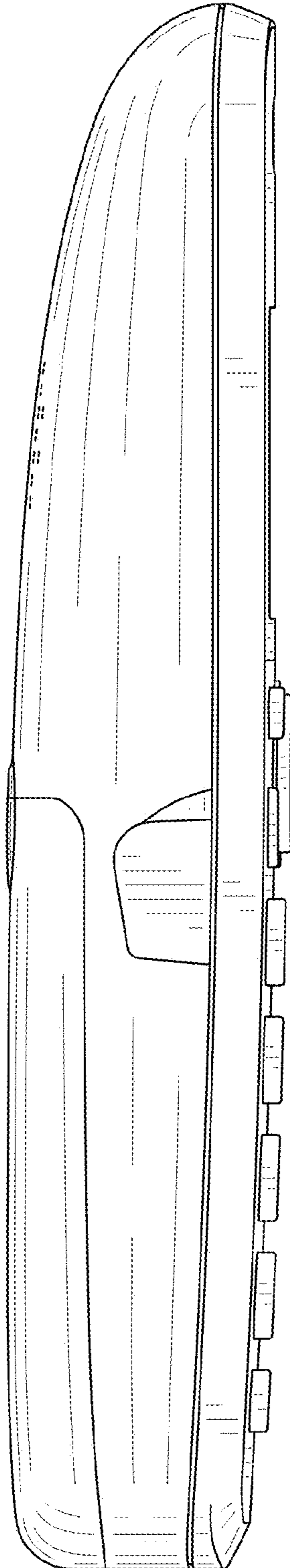

FIG. 4

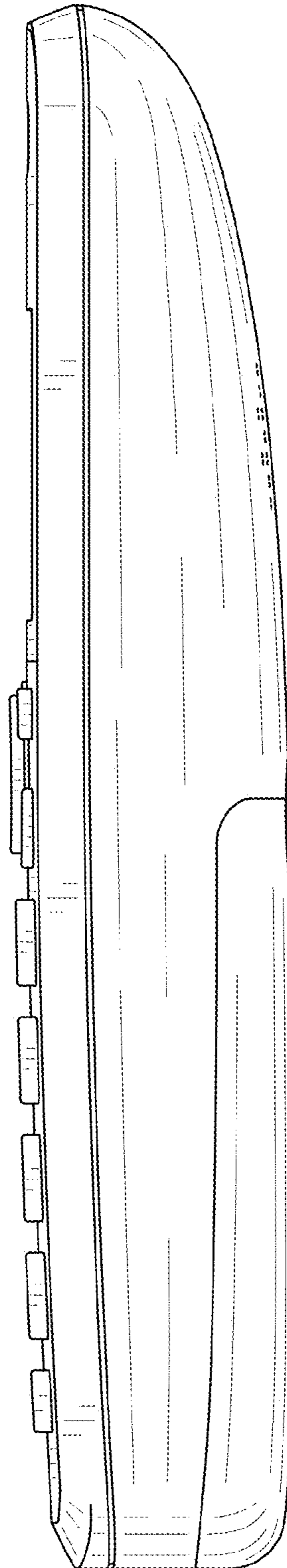

FIG. 5

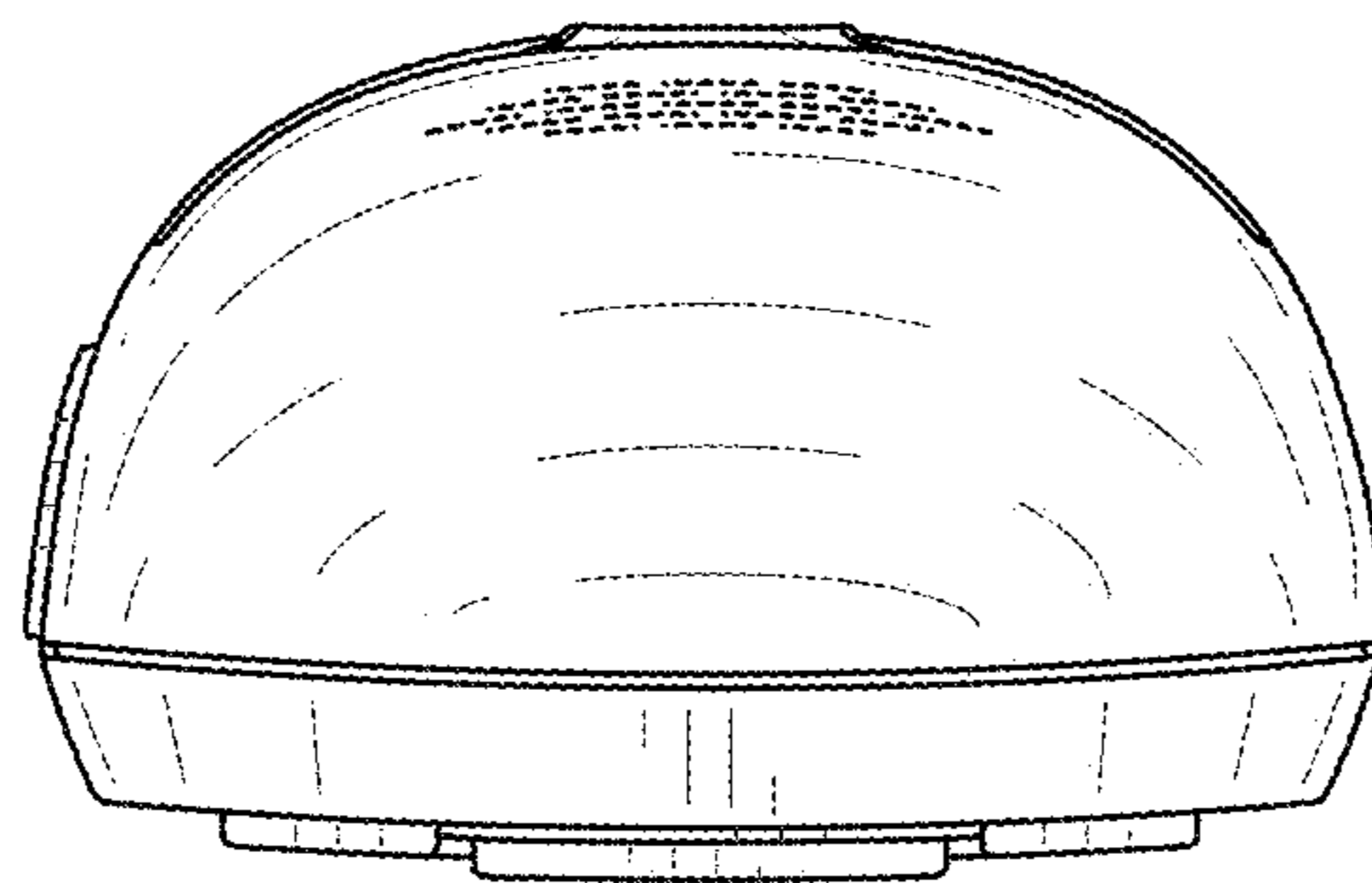

FIG. 6

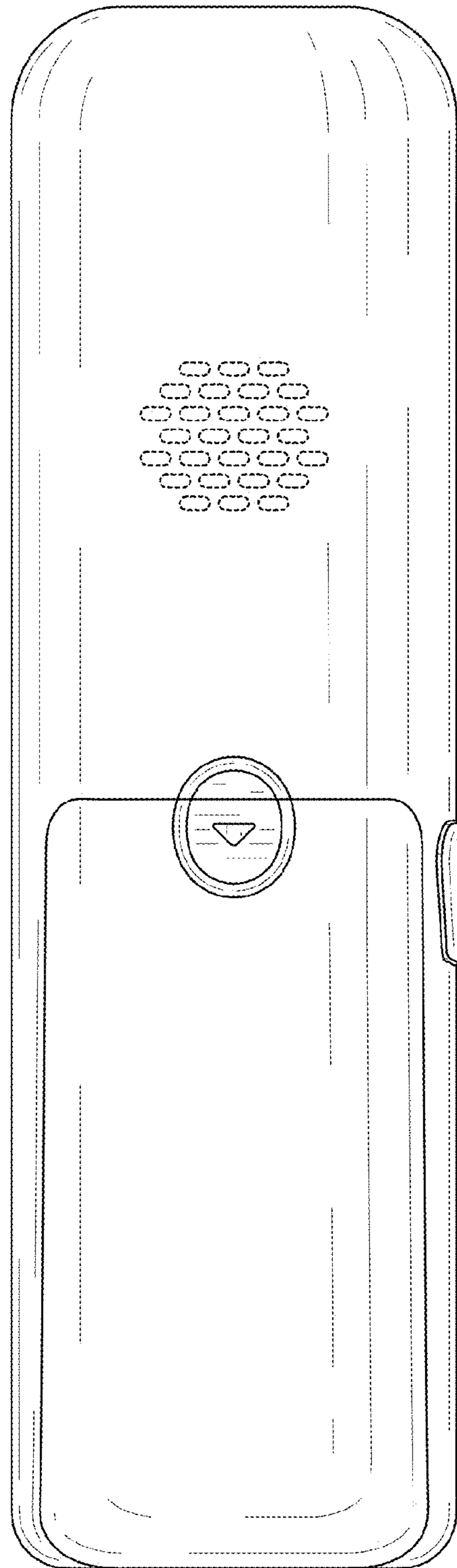

FIG. 7

