



US00D689007S

(12) **United States Design Patent**
Littlechild et al.

(10) **Patent No.:** **US D689,007 S**

(45) **Date of Patent:** **** Sep. 3, 2013**

- (54) **AVIONICS FLIGHT DISPLAY**
- (75) Inventors: **Clive J. Littlechild**, Cedar Rapids, IA (US); **Craig E. Harwood**, Cedar Rapids, IA (US); **Susan T. Schnapp**, Hillsboro, OR (US)
- (73) Assignee: **Rockwell Collins, Inc.**, Cedar Rapids, IA (US)

7,844,372	B2 *	11/2010	Chen et al.	701/11
D630,142	S *	1/2011	da Silveira et al.	D12/192
D634,745	S *	3/2011	Park et al.	D14/373
D669,076	S *	10/2012	Haller	D14/374
2007/0150124	A1 *	6/2007	Wipplinger et al.	701/3
2008/0012730	A1 *	1/2008	Soler	340/973
2009/0045982	A1 *	2/2009	Caillaud et al.	340/972
2010/0204855	A1 *	8/2010	Vial	701/14
2010/0262319	A1 *	10/2010	Gunn et al.	701/3
2010/0332054	A1 *	12/2010	Brandao et al.	701/3

(**) Term: **14 Years**

(21) Appl. No.: **29/414,493**

(22) Filed: **Feb. 29, 2012**

(51) **LOC (9) Cl.** **12-07**

(52) **U.S. Cl.**
USPC **D12/345**

(58) **Field of Classification Search**
USPC D12/192, 319, 345, 415; D14/336, D14/371, 373, 374; D21/430, 442, 447, D21/448, 449, 450, 451; 244/1 R, 118.5, 244/220, 221, 234; 280/1.12; 340/945, 946, 340/947, 971, 973, 974, 975, 980; 345/168; 446/230, 231, 232; 701/3, 11, 14, 17, 18; 702/121, 122

See application file for complete search history.

(56) **References Cited**

U.S. PATENT DOCUMENTS

D310,346	S *	9/1990	Allred	D12/192
6,381,519	B1 *	4/2002	Snyder	701/3
D469,746	S *	2/2003	Soule, Jr.	D14/127
6,970,104	B2 *	11/2005	Knecht et al.	340/945
7,307,549	B2 *	12/2007	Firra	340/974
7,321,318	B2 *	1/2008	Crane et al.	340/971

* cited by examiner

Primary Examiner — Caron D Veynar

Assistant Examiner — Martie K Holtje

(74) *Attorney, Agent, or Firm* — Donna P. Suchy; Daniel M. Barbieri

(57) **CLAIM**

The ornamental design for an avionics flight display, as shown and described.

DESCRIPTION

FIG. 1 is a right front perspective view of an avionics flight display showing our new design; FIG. 2 is a top plan view thereof; FIG. 3 is a front elevational view thereof; FIG. 4 is a right side elevational view thereof; FIG. 5 is a rear elevational view thereof; FIG. 6 is a left side elevational view thereof; and, FIG. 7 is a bottom plan view thereof.

The broken lines depicting structural elements have been shown for the purpose of illustrating environment which forms no part of the claimed design.

1 Claim, 7 Drawing Sheets

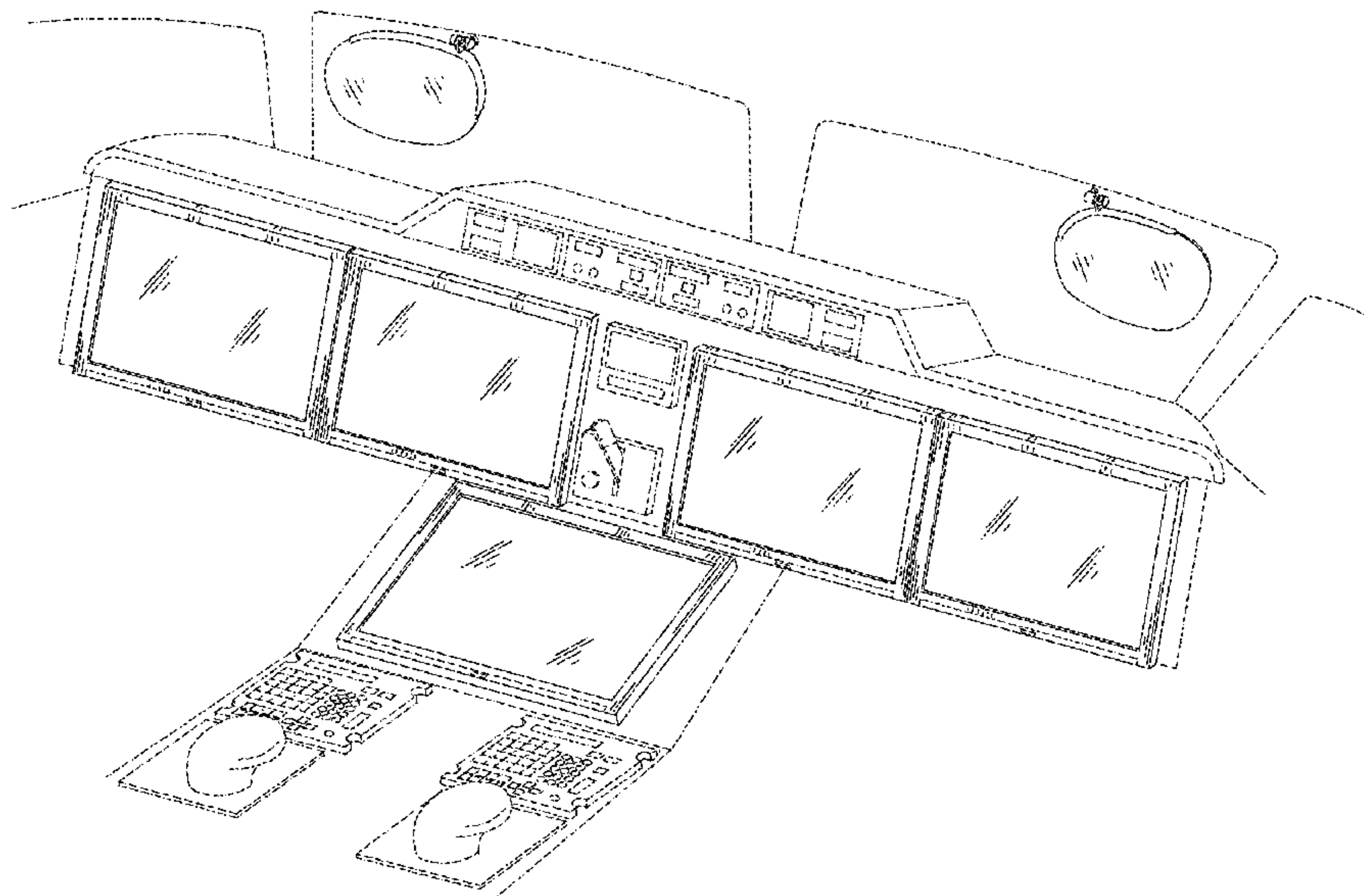

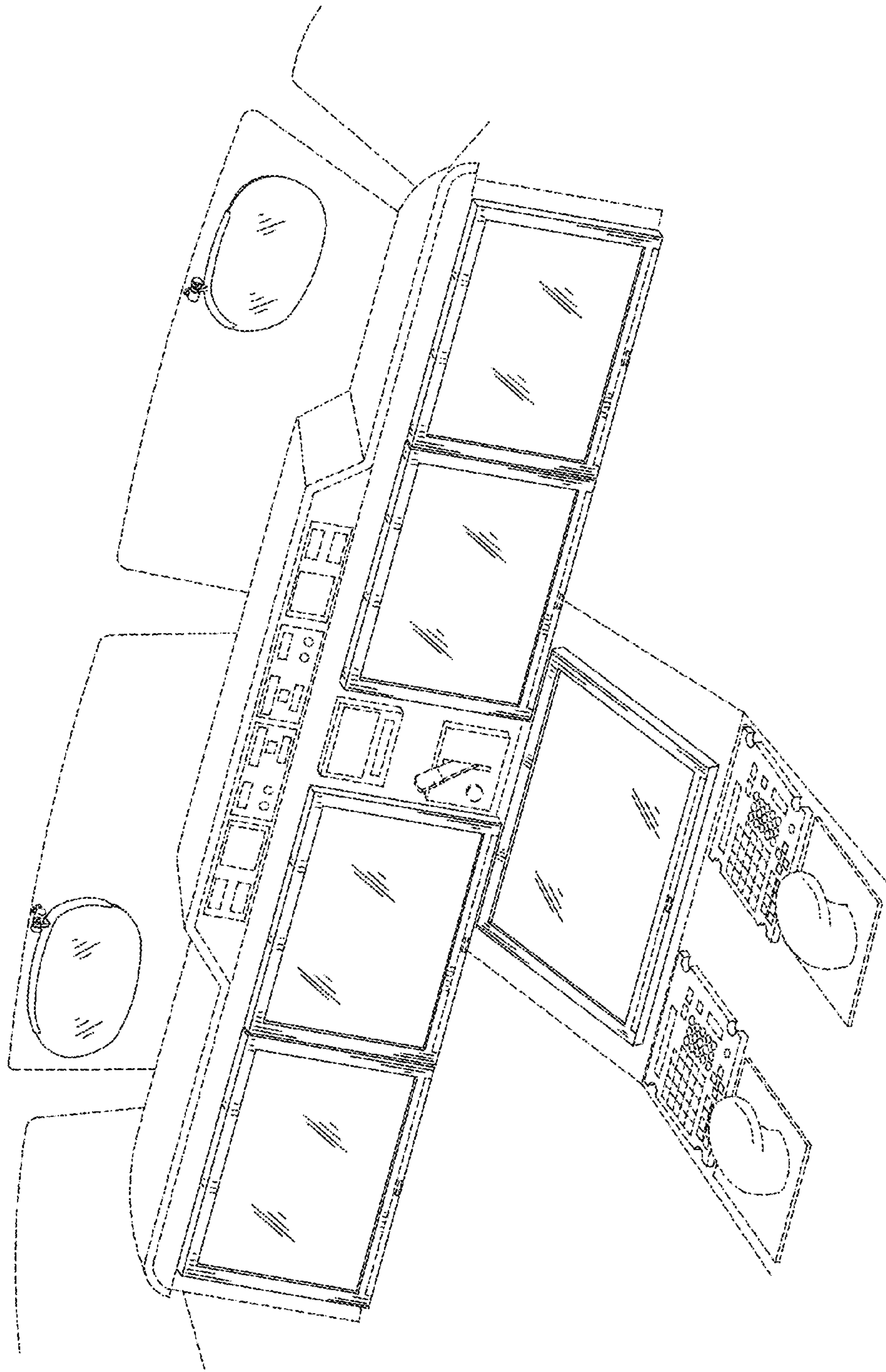

FIG. 1

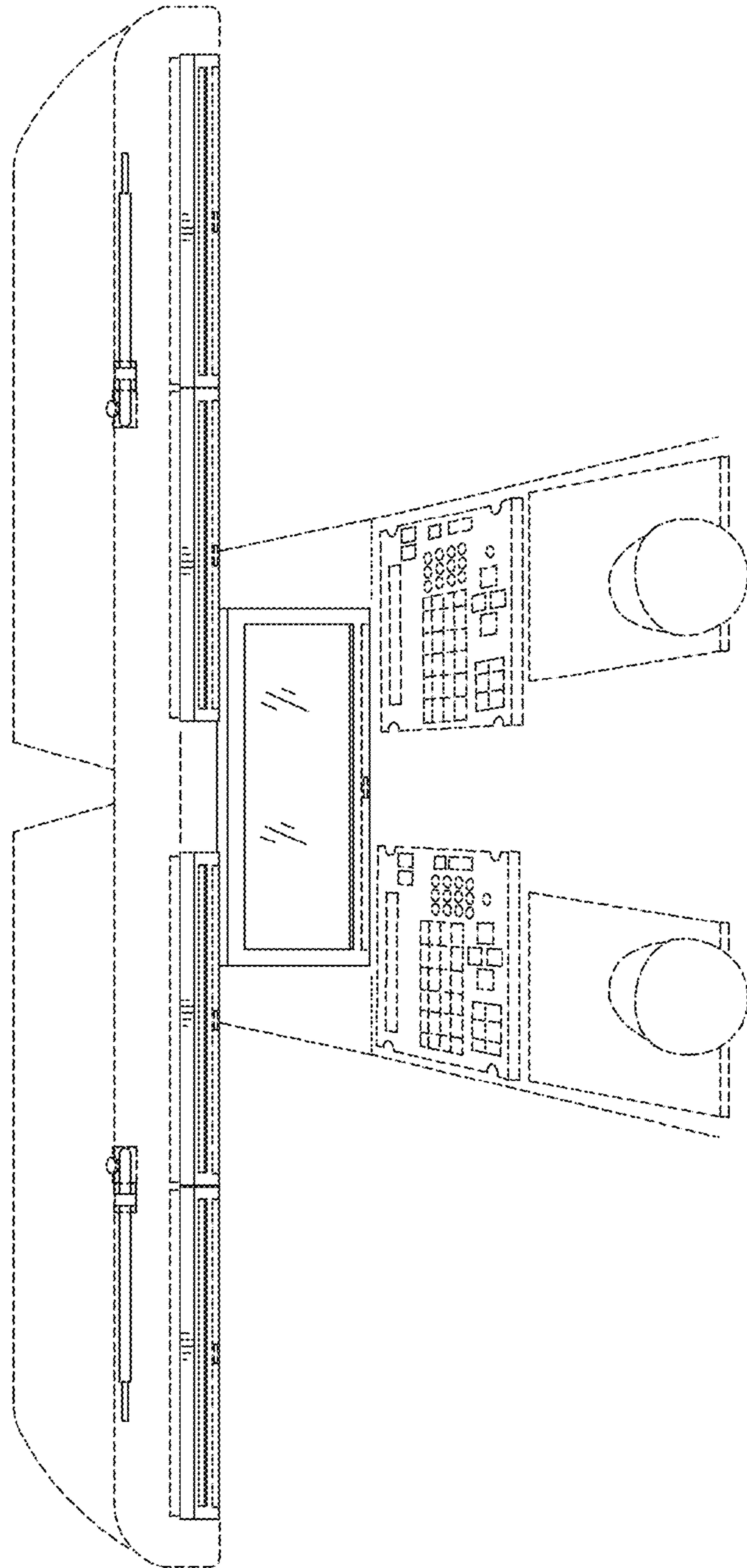

FIG. 2

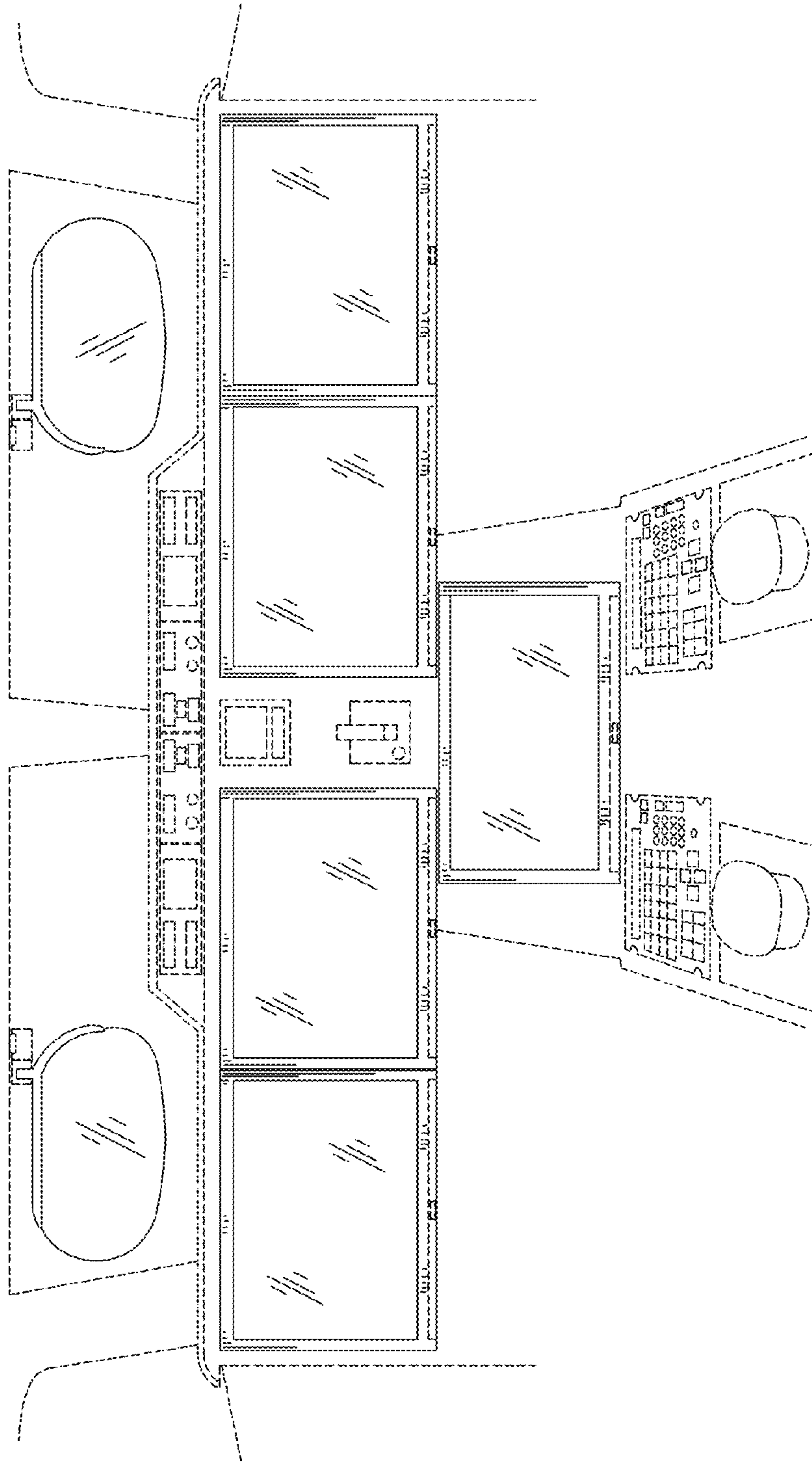

FIG. 3

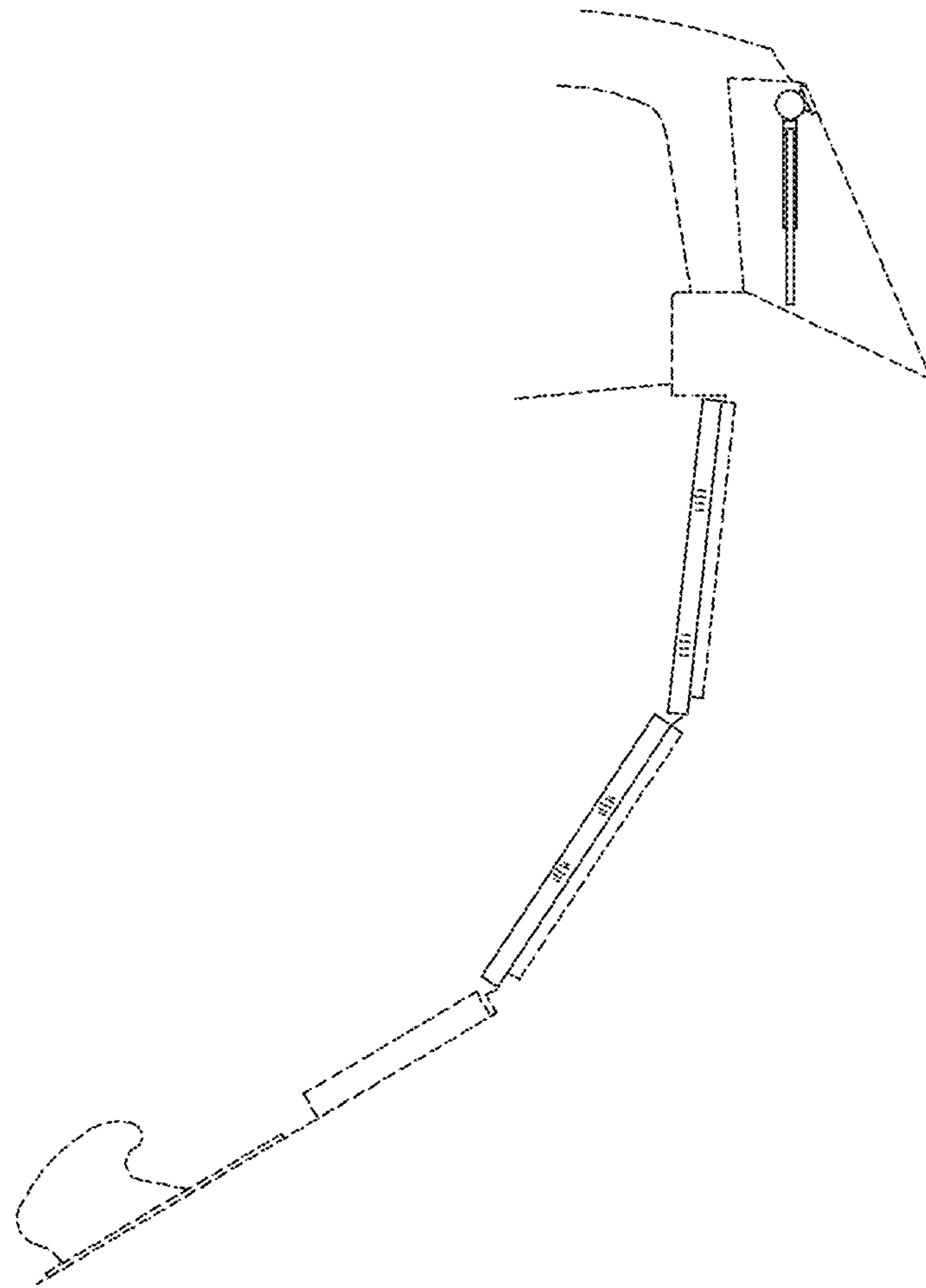

FIG. 4

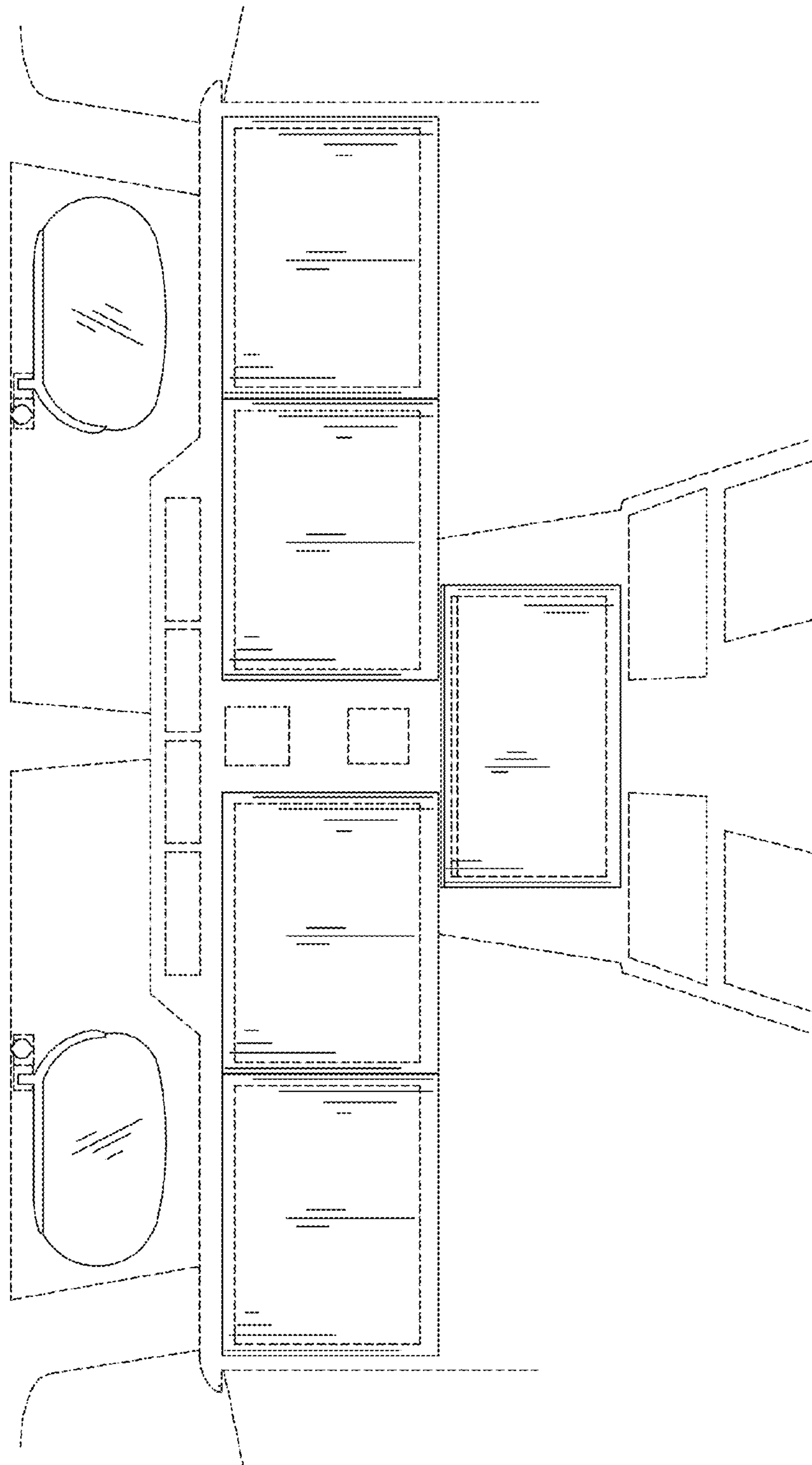

FIG. 5

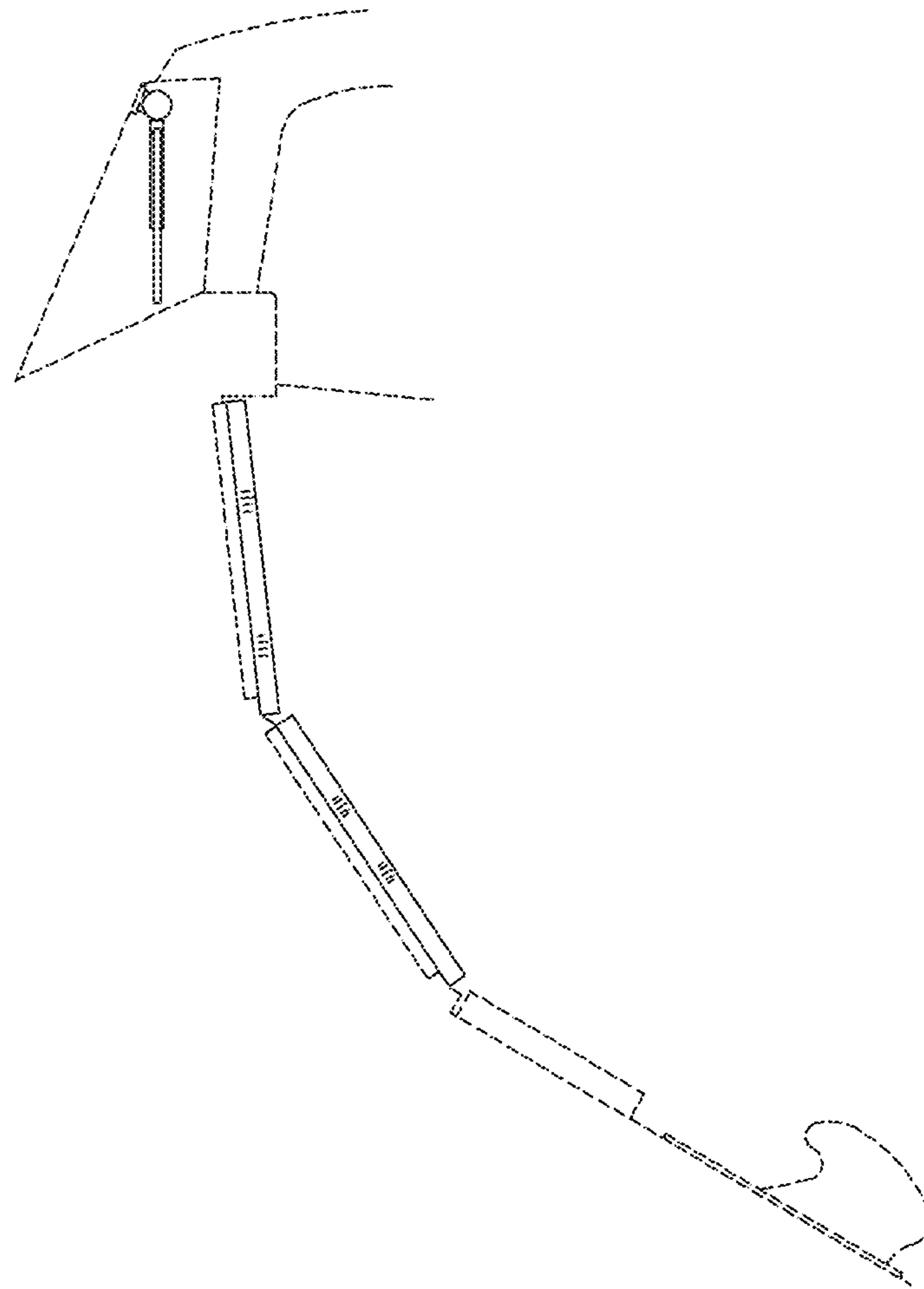

FIG. 6

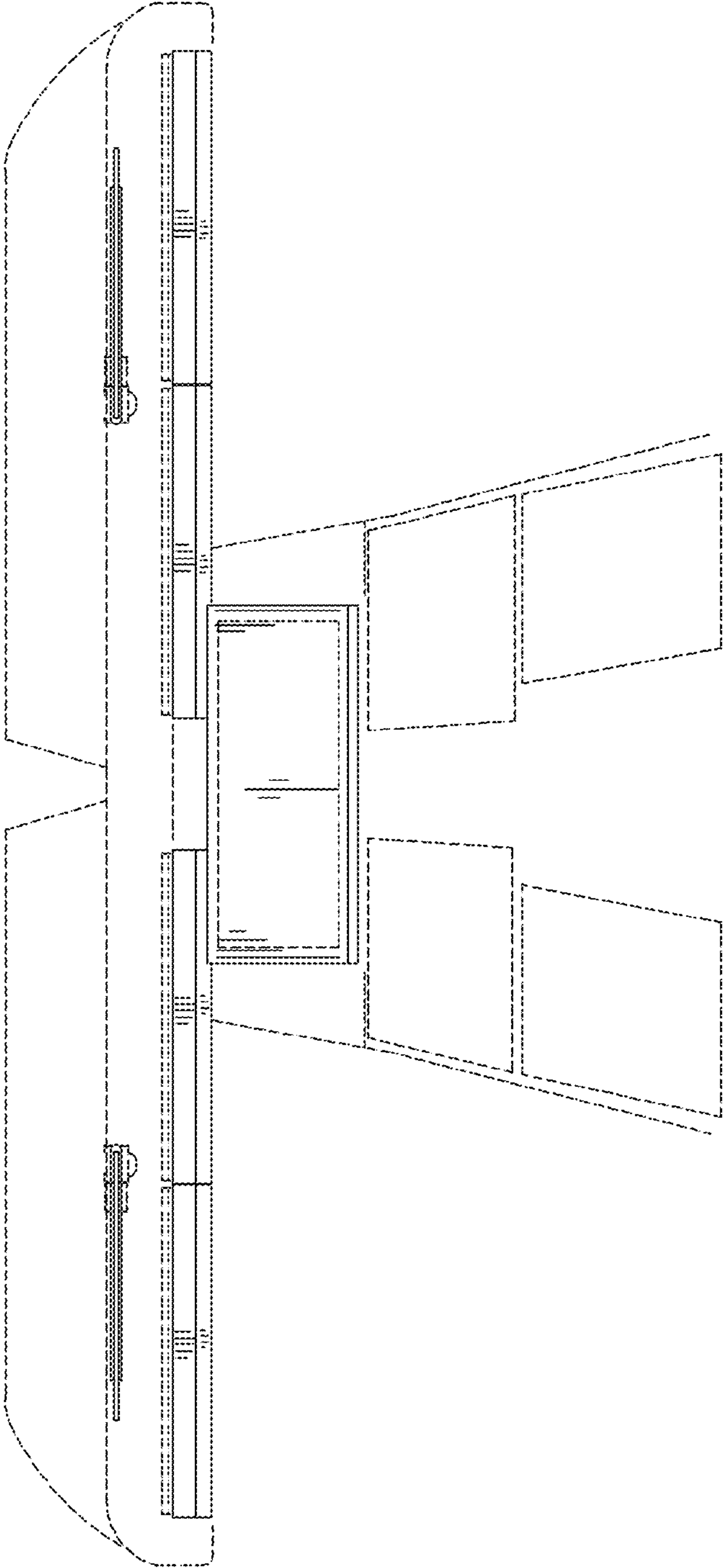

FIG. 7