



US00D688870S

(12) **United States Design Patent**
Levie

(10) **Patent No.:** **US D688,870 S**
(45) **Date of Patent:** **** Sep. 3, 2013**

- (54) **BASKET**
- (71) Applicant: **Discovery Inc.**, Ross, CA (US)
- (72) Inventor: **Mark Levie**, Ross, CA (US)
- (73) Assignee: **Discovery Inc.**, Ross, CA (US)
- (**) Term: **14 Years**
- (21) Appl. No.: **29/445,353**
- (22) Filed: **Feb. 11, 2013**

Related U.S. Application Data

- (62) Division of application No. 29/424,218, filed on Jun. 8, 2012, now Pat. No. Des. 675,825.
- (51) **LOC (9) Cl.** **03-01**
- (52) **U.S. Cl.**
USPC **D3/311**
- (58) **Field of Classification Search**
USPC D3/304–315, 318–319; D6/525;
206/201, 203, 503, 509, 511–512, 429, 139;
220/515–519, 488
See application file for complete search history.

References Cited

U.S. PATENT DOCUMENTS

D264,040 S	4/1982	Kunze	
D305,274 S *	12/1989	Yoshikawa	D3/314
D326,550 S	5/1992	Waterman	
5,197,613 A	3/1993	Kotlowski	
D351,266 S *	10/1994	Licari	D32/37
D372,568 S *	8/1996	Lippisch	D32/37
D376,231 S *	12/1996	McLain	D32/37
D392,431 S *	3/1998	Schallern	D32/37
D392,782 S	3/1998	McLain	
D401,024 S	11/1998	Seymour	
D401,065 S *	11/1998	Peltola	D3/304
D405,268 S	2/1999	Apenes	

D406,698 S	3/1999	Miller	
D425,275 S *	5/2000	Delouvre et al.	D32/37
D433,548 S	11/2000	Baines et al.	
D440,020 S	4/2001	Ronson et al.	
D462,149 S *	8/2002	Hall	D32/37
D512,223 S	12/2005	Snell	
D533,327 S *	12/2006	McCaskill	D34/17
D546,511 S	7/2007	Luster	
D549,454 S	8/2007	Åhman	
D550,912 S *	9/2007	Kempske	D32/37
D559,621 S *	1/2008	Raichlen et al.	D7/409
D584,020 S *	12/2008	McNamara	D32/37
D586,558 S	2/2009	Ziemann et al.	
D603,197 S	11/2009	Hrovat	
D604,769 S	11/2009	Chen et al.	
D629,682 S	12/2010	Overgaag	
D633,270 S	2/2011	Gimeno et al.	
D634,482 S	3/2011	Sullivan	
D635,363 S	4/2011	Hertaus	
D636,952 S	4/2011	Baldwin et al.	
D641,266 S	7/2011	Tamura et al.	

(Continued)

Primary Examiner — Kelley Donnelly

(74) *Attorney, Agent, or Firm* — Pearne & Gordon LLP

(57)

CLAIM

The ornamental design for a basket, as shown and described.

DESCRIPTION

FIG. 1 is a perspective view of an example basket;
 FIG. 2 is a right side plan view thereof, the left side plan view being a mirror image thereof;
 FIG. 3 is an end view thereof;
 FIG. 4 is a front view thereof;
 FIG. 5 is a top view thereof; and,
 FIG. 6 is a bottom view thereof.
 The broken line showings of FIGS. 1-6 are for illustrative purposes only and form no part of the claimed design.
 The broken lines that define the bounds of the claimed design form no part thereof.

1 Claim, 5 Drawing Sheets

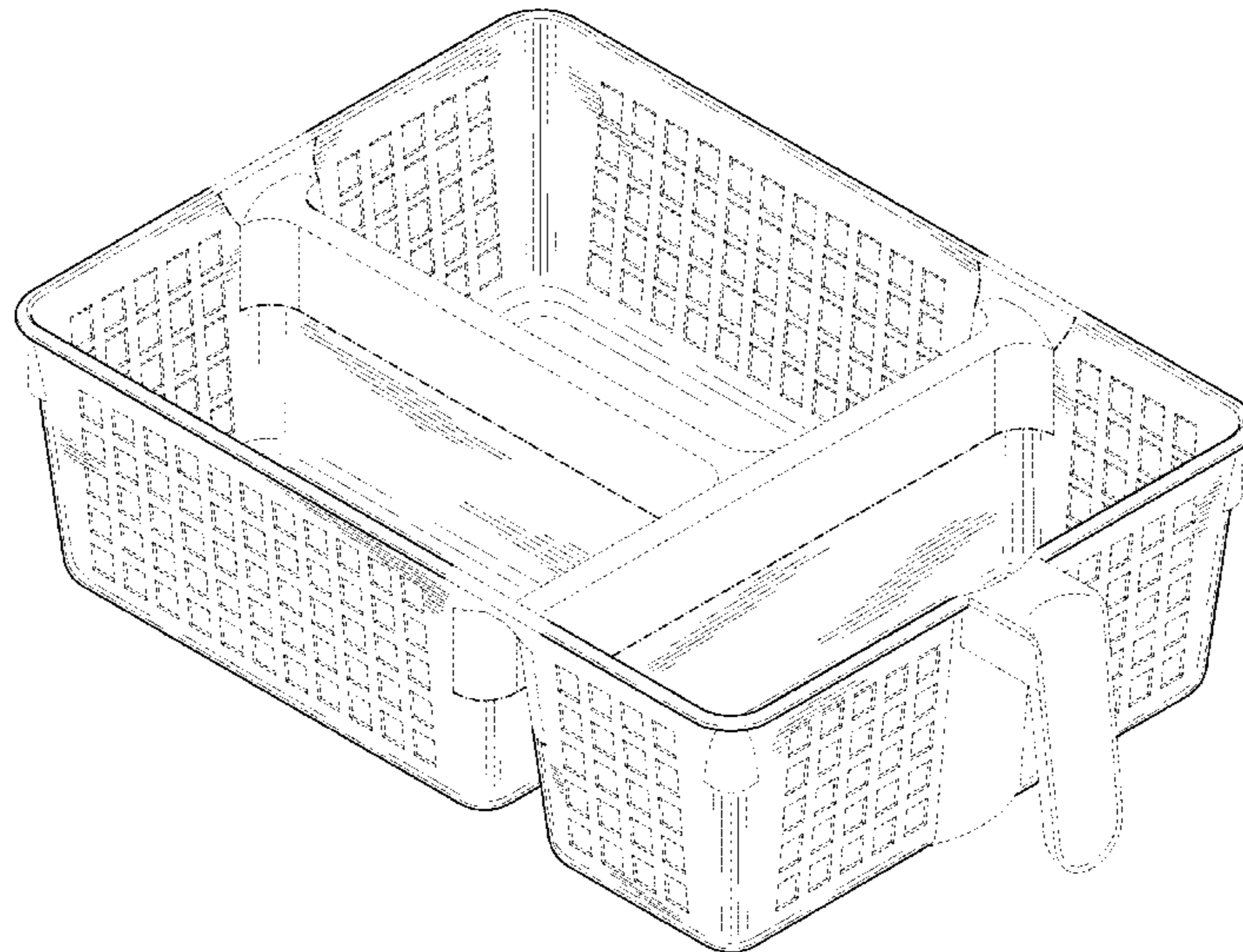

US D688,870 S

Page 2

(56)

References Cited

U.S. PATENT DOCUMENTS

D655,506 S 3/2012 Humm et al.

D659,398 S * 5/2012 Wood D3/304

D664,004 S 7/2012 Benishai

D665,848 S 8/2012 Lee

D675,825 S * 2/2013 Levie D3/311

* cited by examiner

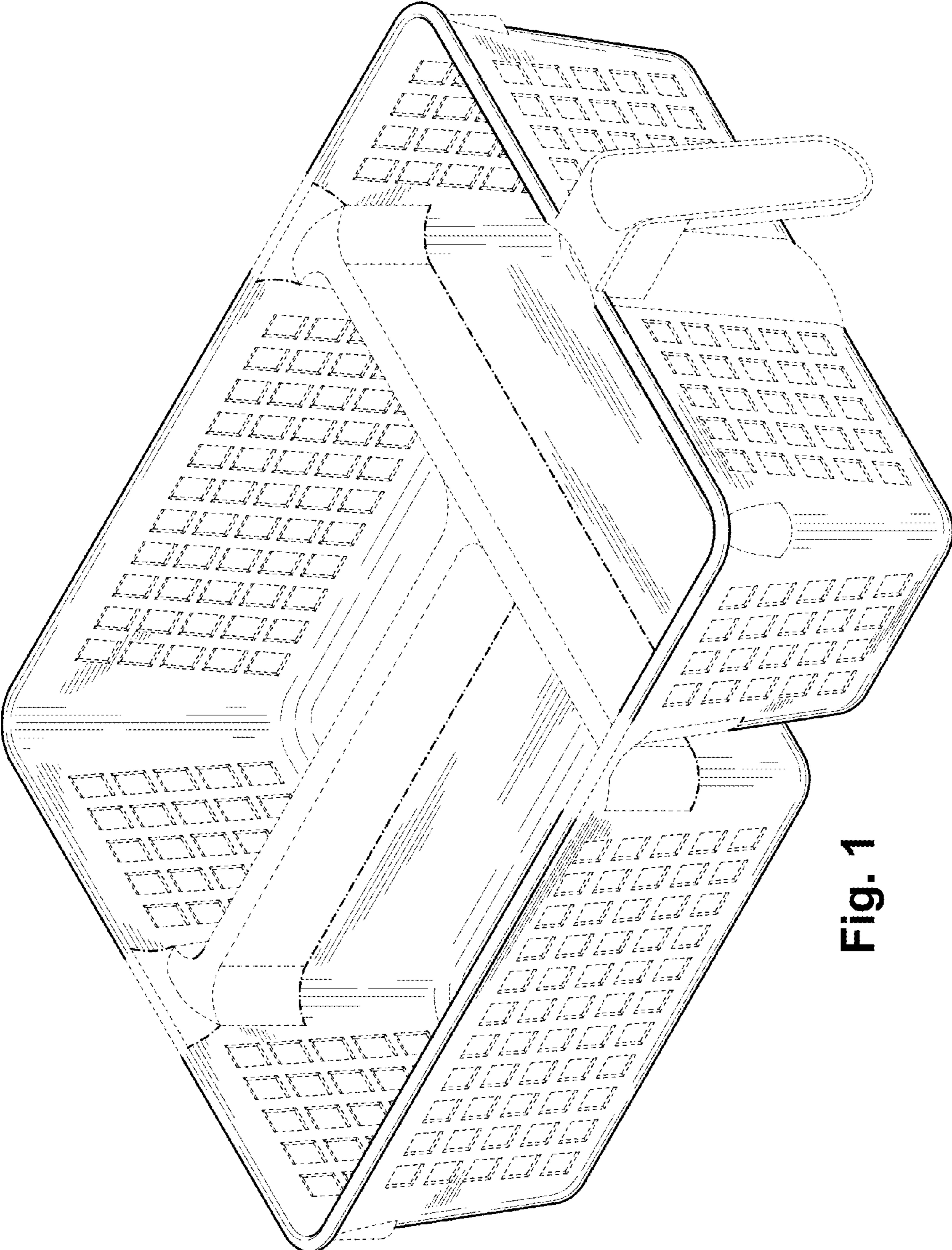

Fig. 1

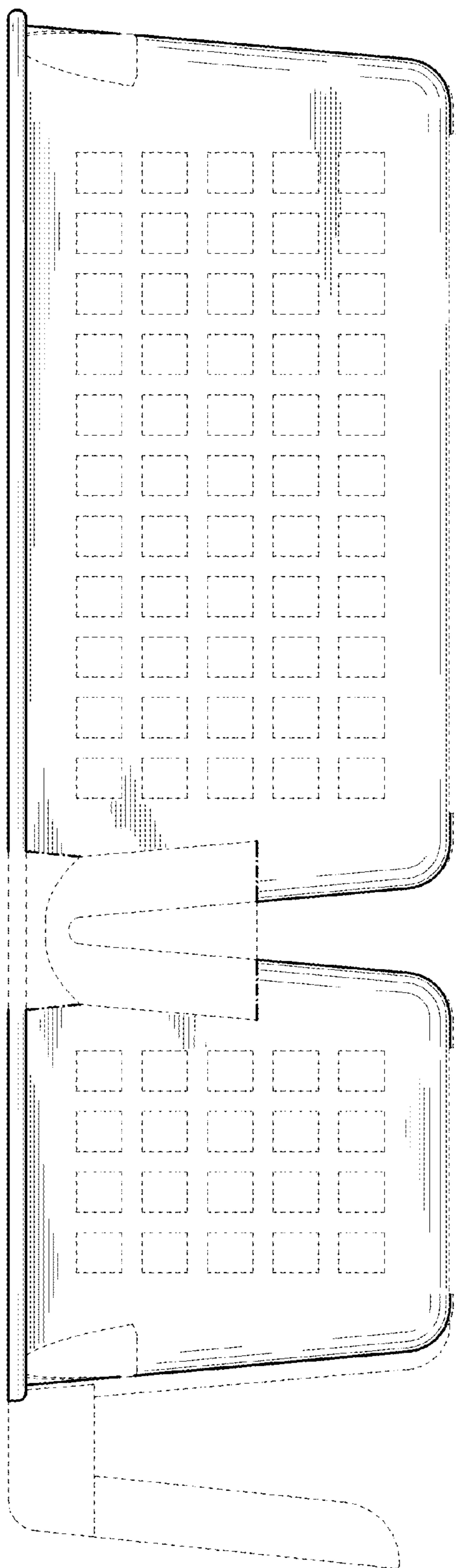

Fig. 2

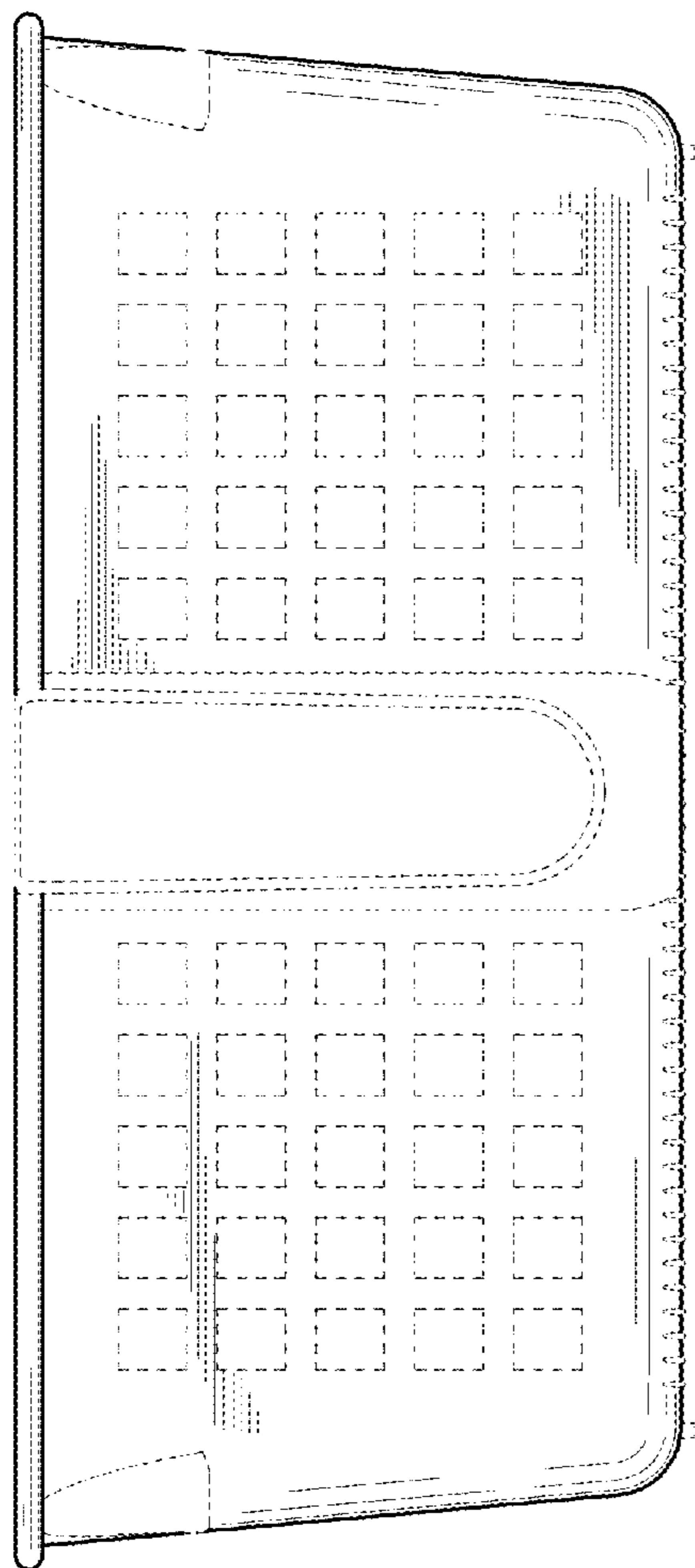

Fig. 3

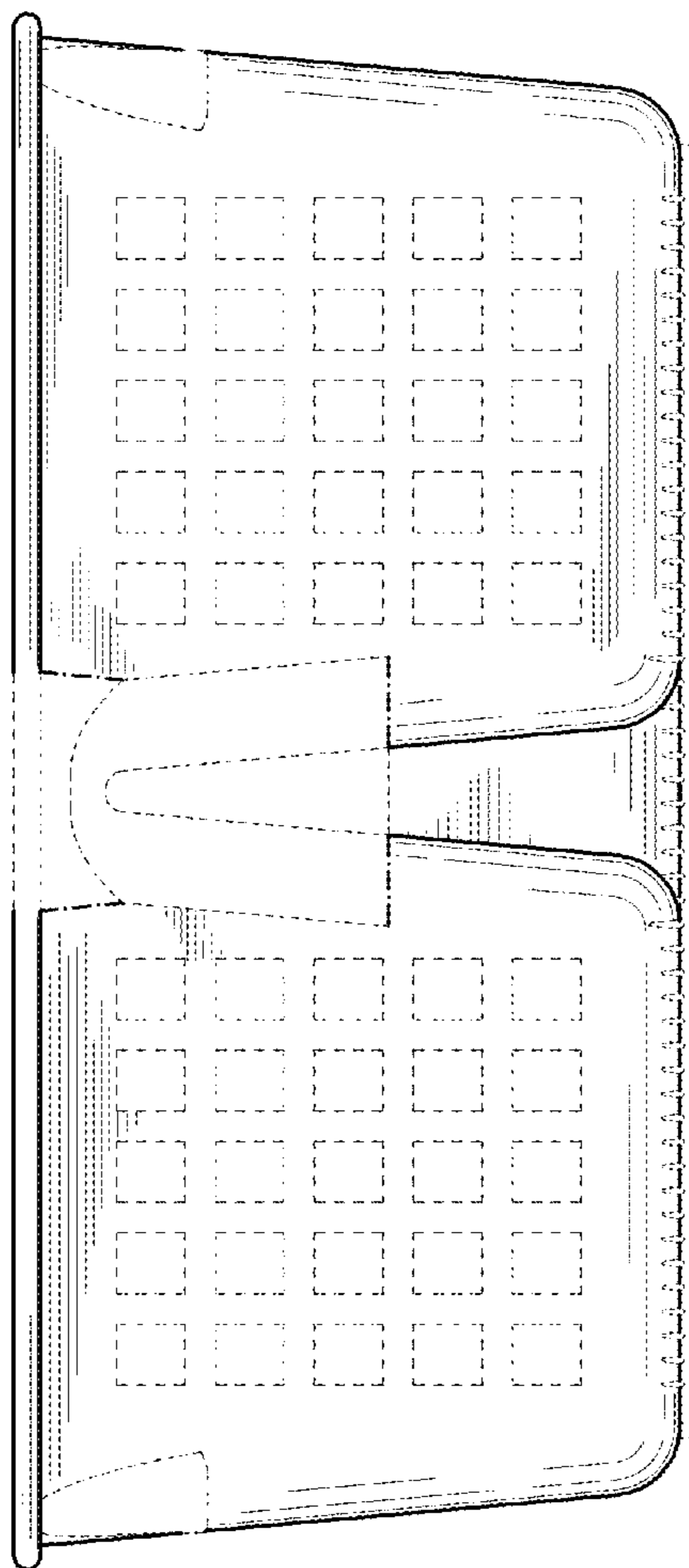

Fig. 4

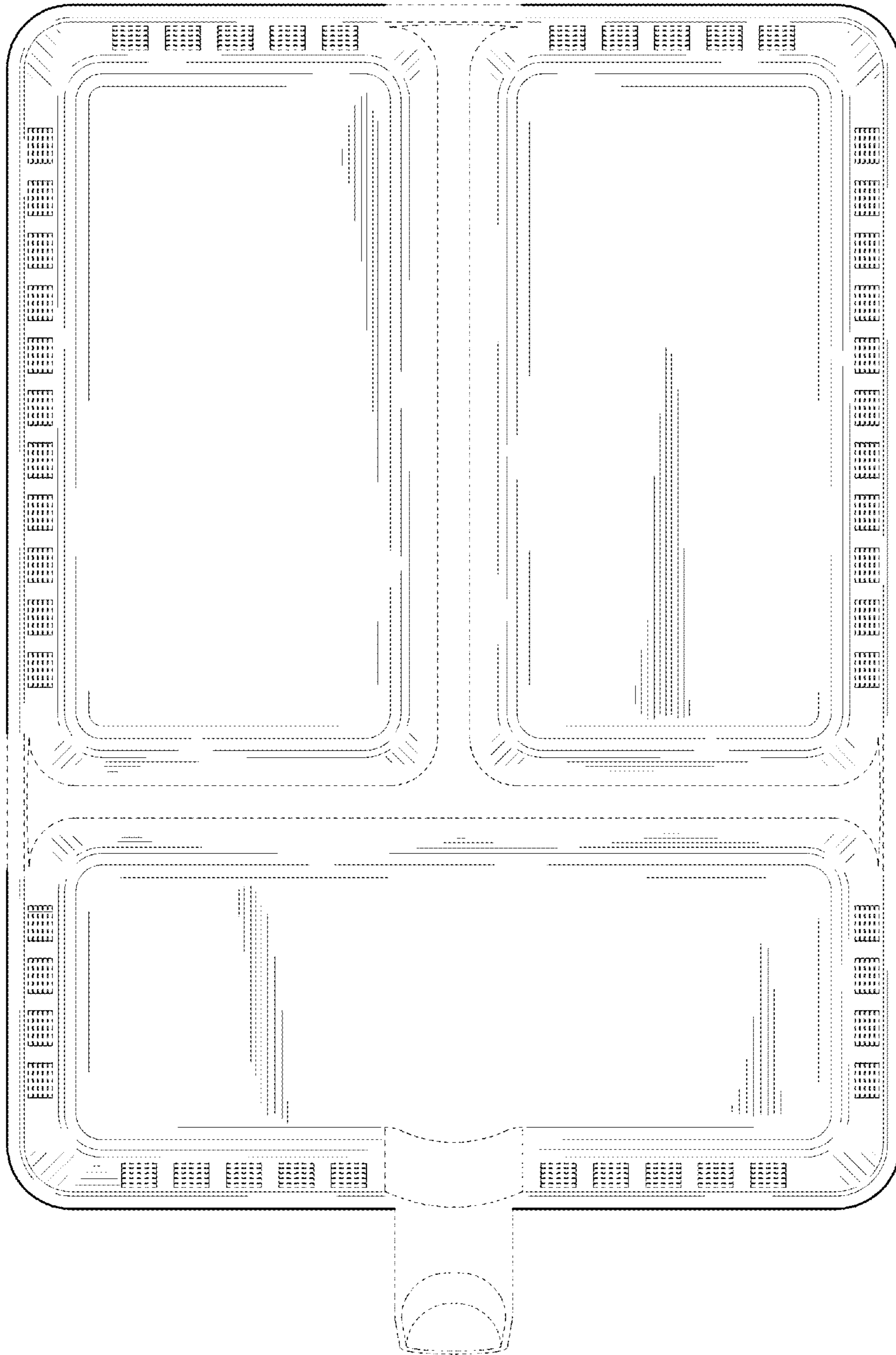

Fig. 5

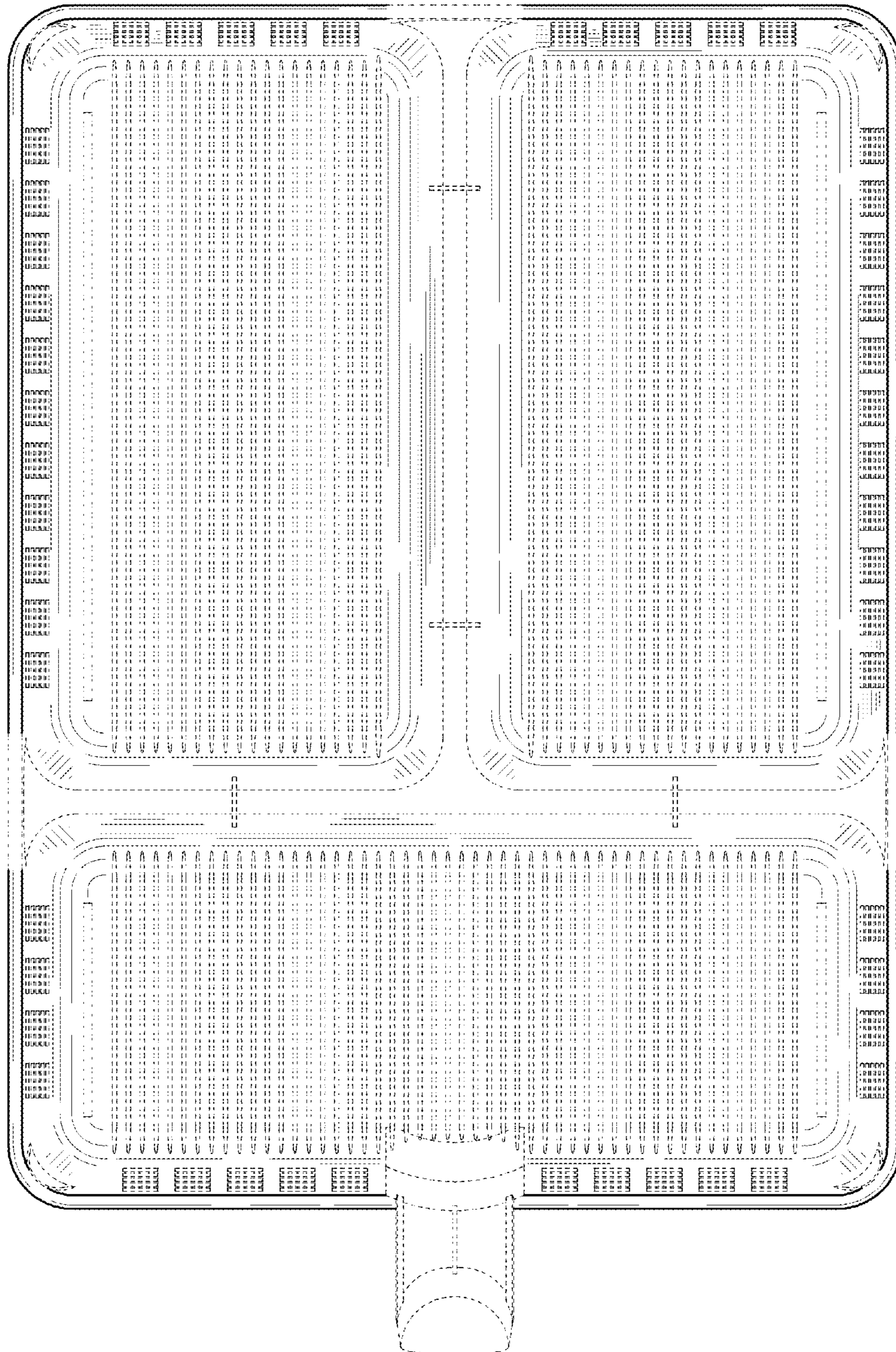

Fig. 6