



US00D688829S

(12) **United States Design Patent**  
**Hammer**

(10) **Patent No.:** **US D688,829 S**

(45) **Date of Patent:** **\*\* Aug. 27, 2013**

(54) **COSMETIC CONTAINER**

(75) Inventor: **Daniela Hammer**, Ellingen (DE)

(73) Assignee: **GEKA GmbH**, Bechhofen (DE)

(\*\*) Term: **14 Years**

(21) Appl. No.: **29/425,480**

(22) Filed: **Jun. 22, 2012**

(51) **LOC (9) Cl.** ..... **28-03**

(52) **U.S. Cl.**  
USPC ..... **D28/76**

(58) **Field of Classification Search**  
USPC ..... D28/76-84, 73; 206/581, 823;  
132/286-318, 320, 319  
See application file for complete search history.

(56) **References Cited**

**U.S. PATENT DOCUMENTS**

6,050,418 A \* 4/2000 Kohler ..... 206/581  
6,895,976 B2 \* 5/2005 Hetzler et al. .... 206/581  
D539,481 S \* 3/2007 Lui ..... D28/83

D607,153 S \* 12/2009 Campbell et al. .... D28/76  
2010/0025285 A1 \* 2/2010 Campbell et al. .... 206/581  
2010/0300476 A1 \* 12/2010 Bennett ..... 132/218

\* cited by examiner

*Primary Examiner* — Jennifer Rivard

(74) *Attorney, Agent, or Firm* — Setter Roche LLP

(57) **CLAIM**

The ornamental design for a cosmetic container, as shown and described.

**DESCRIPTION**

FIG. 1 is a top view of the claimed design.  
FIG. 2 is a front view of the claimed design.  
FIG. 3 is a bottom view of the claimed design.  
FIG. 4 is a right side view of the claimed design.  
FIG. 5 is a left side view of the claimed design.  
FIG. 6 is a rear view of the claimed design; and,  
FIG. 7 is an isometric view of the claimed design.

**1 Claim, 7 Drawing Sheets**

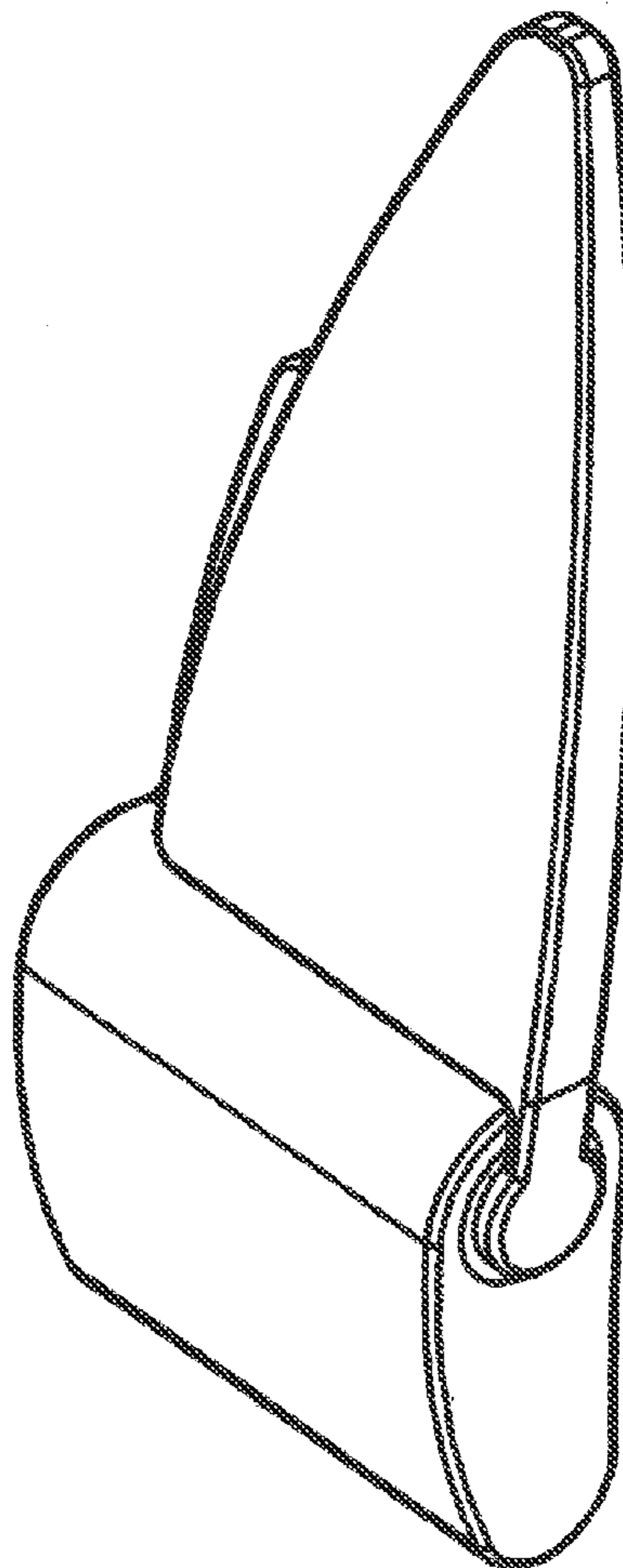

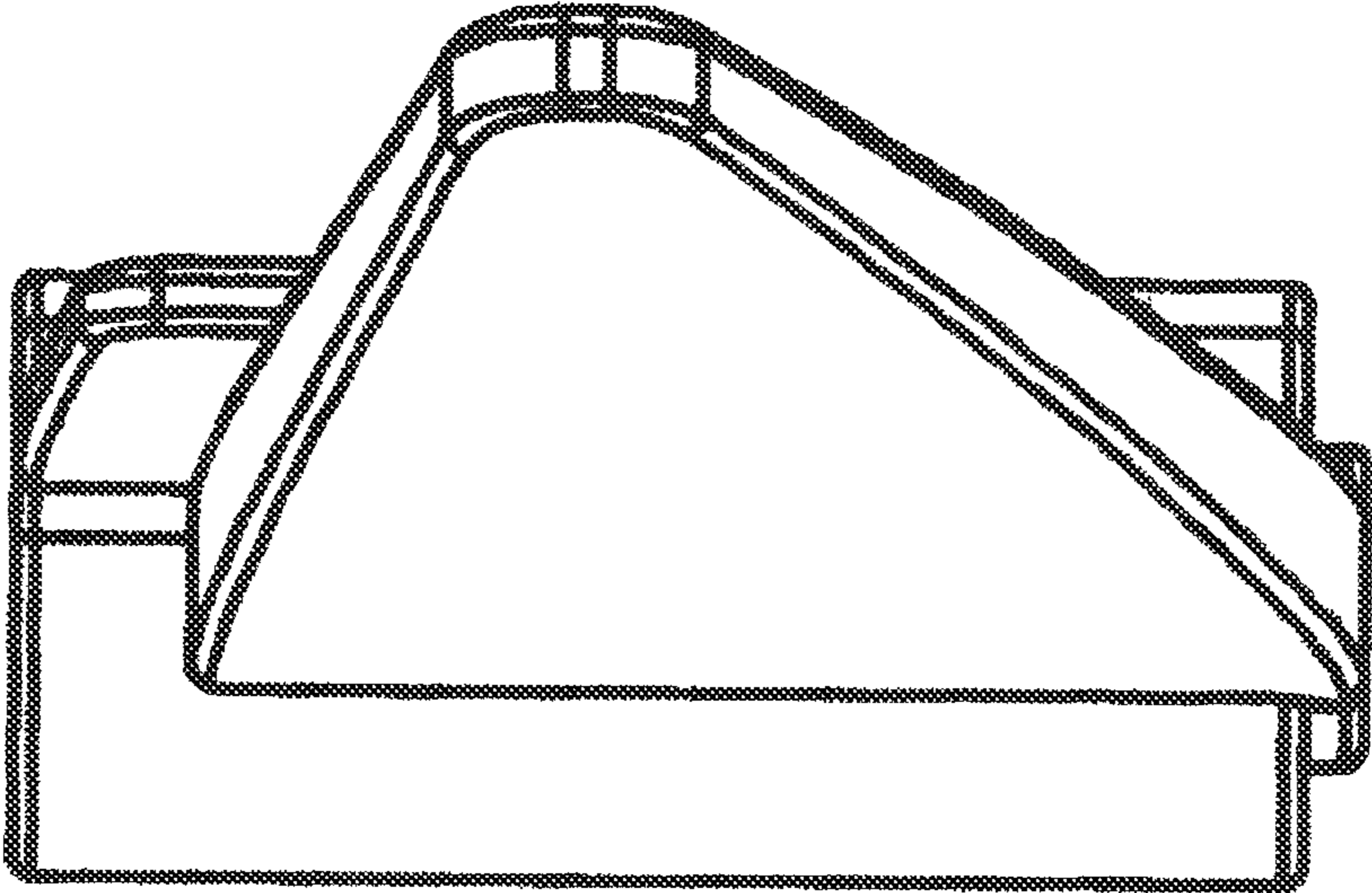

FIG. 1

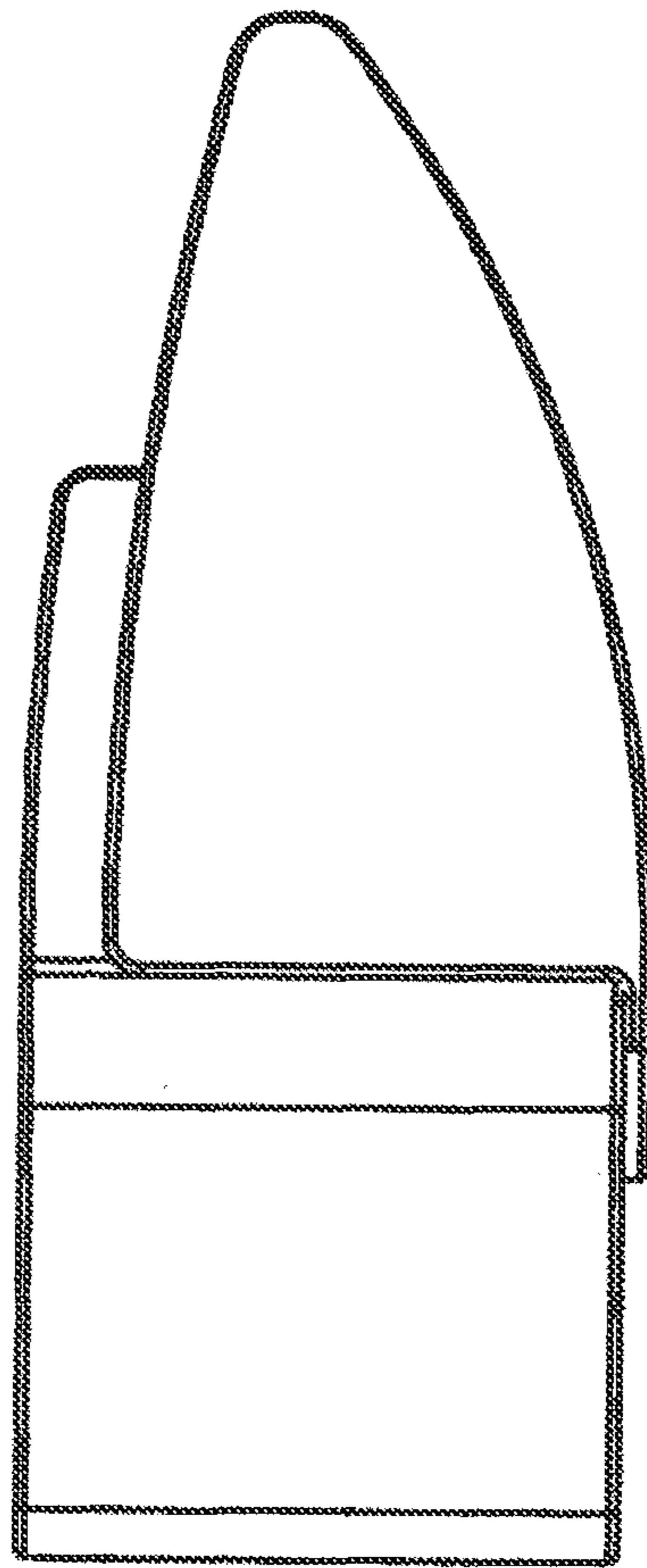

FIG. 2

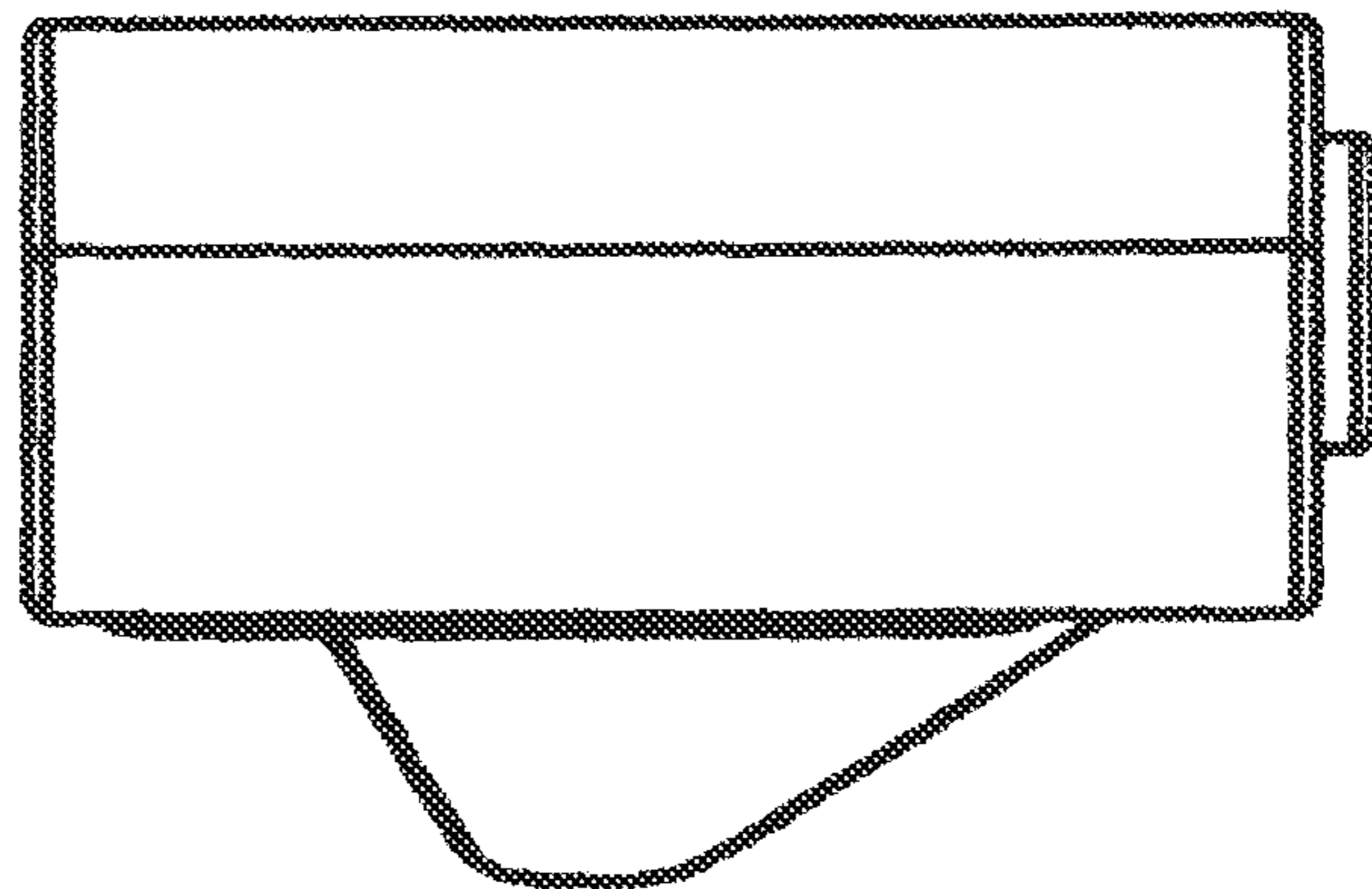

FIG. 3

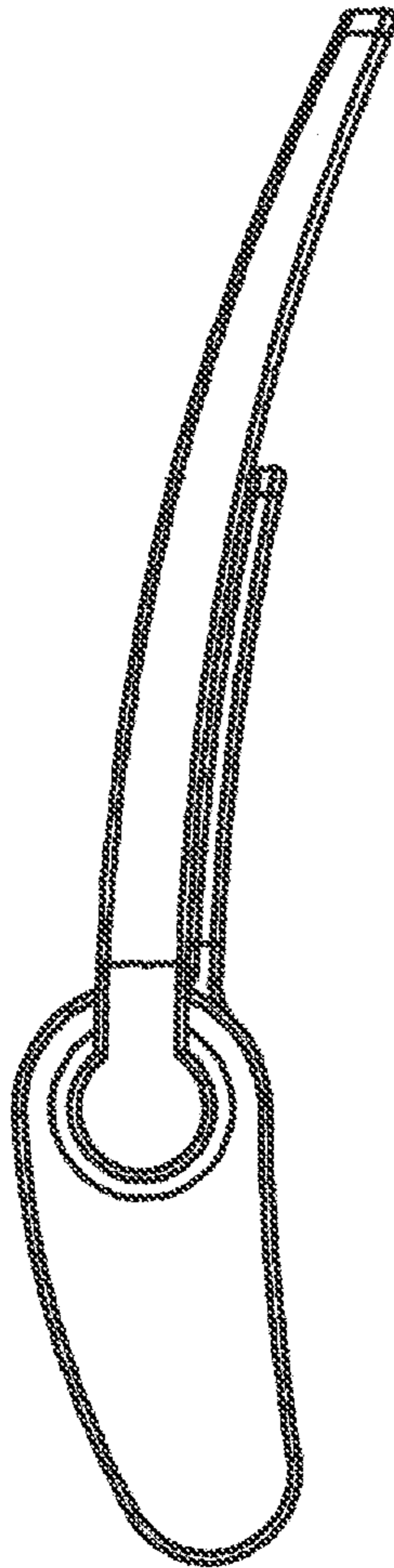

FIG. 4

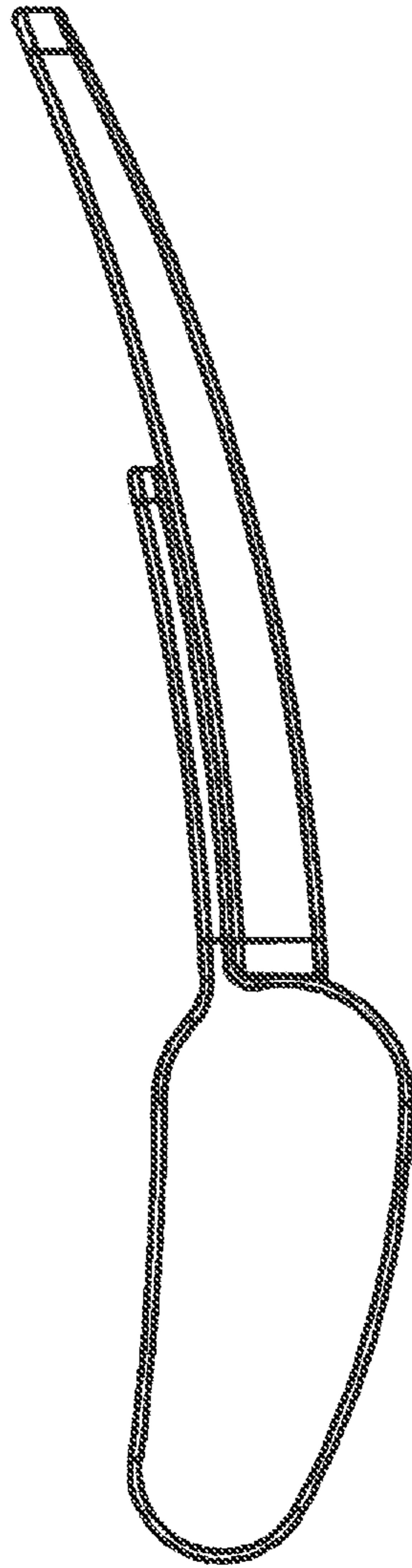

FIG. 5

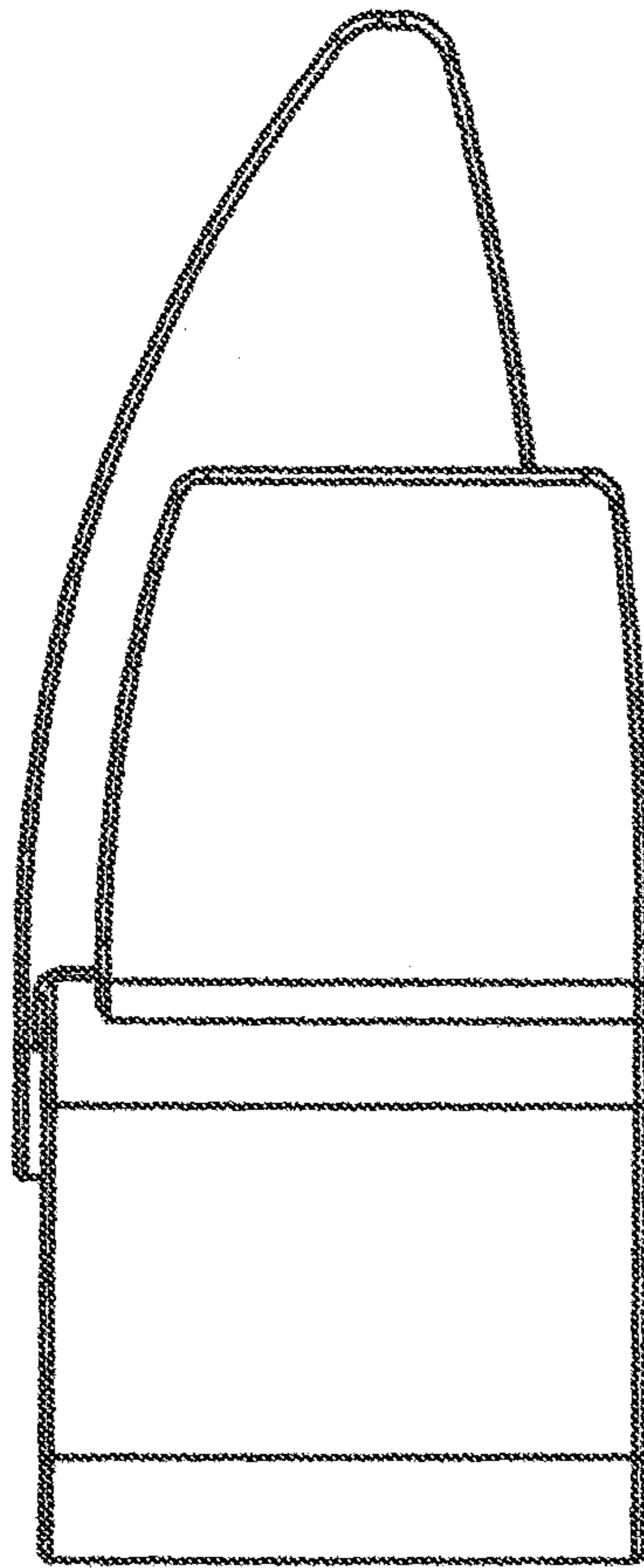

FIG. 6

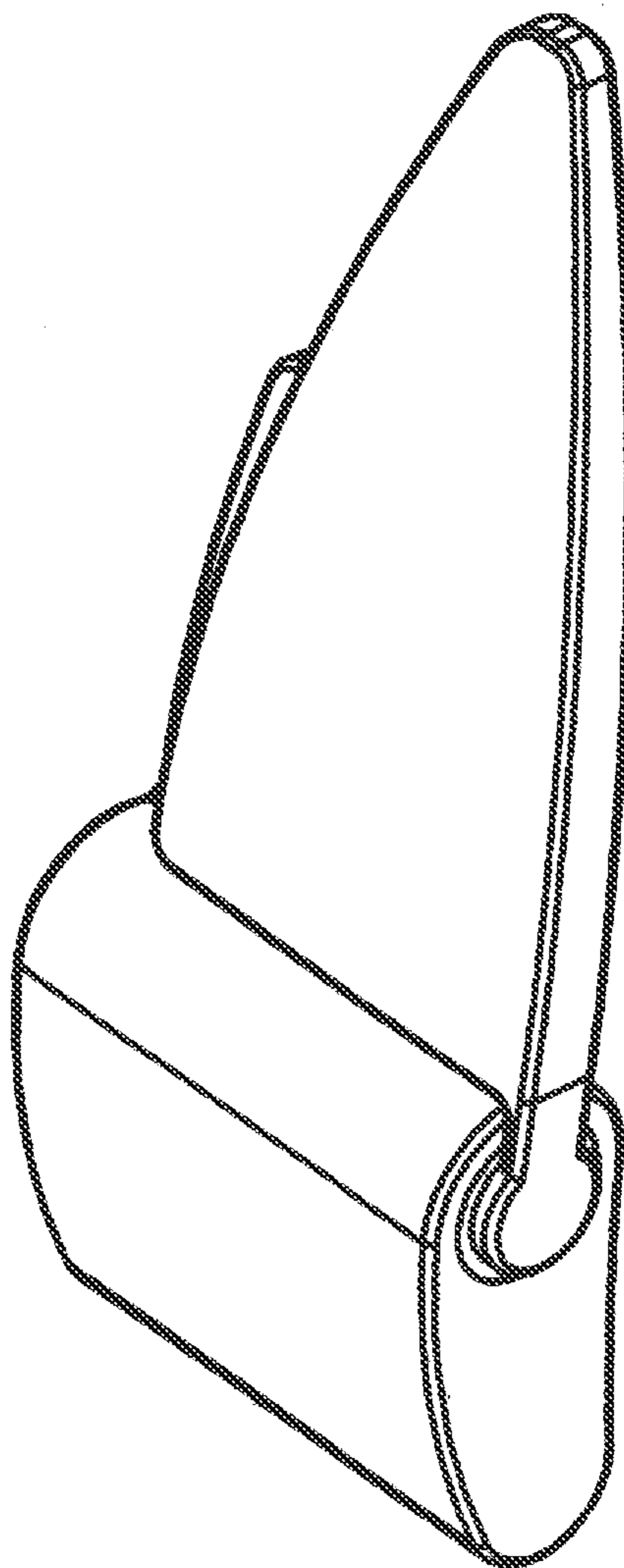

FIG. 7



UNITED STATES PATENT AND TRADEMARK OFFICE  
**CERTIFICATE OF CORRECTION**

PATENT NO. : D688,829 S  
APPLICATION NO. : 29/425480  
DATED : August 27, 2013  
INVENTOR(S) : Daniela Hammer

Page 1 of 1

It is certified that error appears in the above-identified patent and that said Letters Patent is hereby corrected as shown below:

On the Title Page Item [30] should read

Foreign Application Priority Data  
December 23, 2011 (EM) 001967696-0005

Signed and Sealed this  
Seventh Day of January, 2014

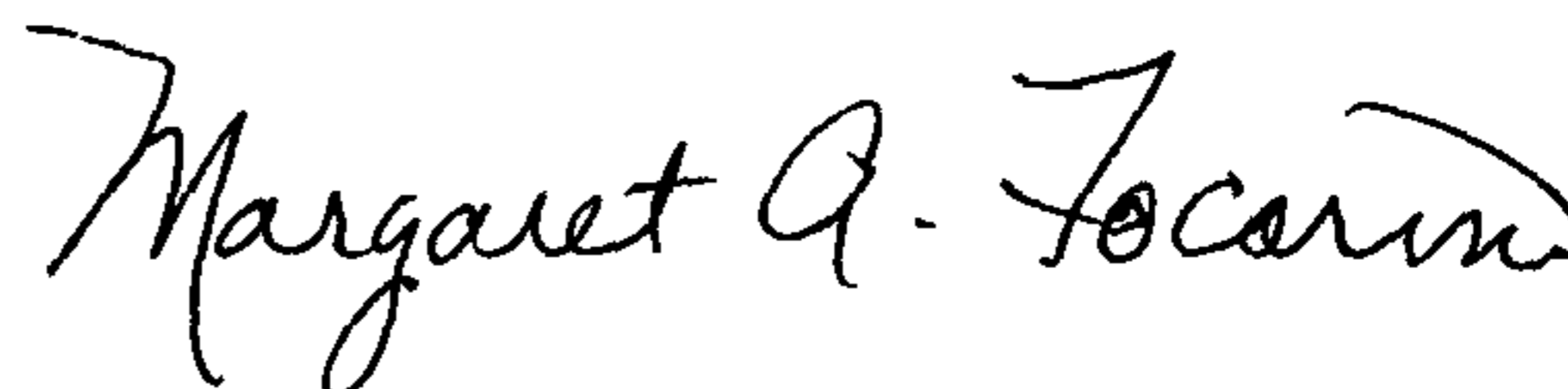

Margaret A. Focarino  
*Commissioner for Patents of the United States Patent and Trademark Office*