



US00D688740S

(12) **United States Design Patent**  
**Applegate et al.**

(10) **Patent No.:** **US D688,740 S**

(45) **Date of Patent:** **\*\* Aug. 27, 2013**

(54) **SHREDDER**

D611,088 S 3/2010 Kent et al.  
D616,925 S 6/2010 Kim et al.  
D618,275 S 6/2010 Wing et al.

(71) Applicant: **Fellowes, Inc.**, Itasca, IL (US)

(Continued)

(72) Inventors: **Shawn Michael Applegate**, Wood Dale, IL (US); **Tai Hoon K. Matlin**, Round Lake Beach, IL (US); **Roy Whitson**, Franklin, NH (US); **Jonathan Wesley Morris**, Goffstown, NH (US); **Alan Kenneth Stratton**, Milford, NH (US)

*Primary Examiner* — Bridget L Eland

(74) *Attorney, Agent, or Firm* — Pillsbury Winthrop Shaw Pittman LLP

(73) Assignee: **Fellowes, Inc.**, Itasca, IL (US)

(57) **CLAIM**  
The ornamental design for a shredder, as shown and described.

(\*\*) Term: **14 Years**

**DESCRIPTION**

(21) Appl. No.: **29/443,477**

FIG. 1 is a perspective view of a shredder embodying a first aspect of the design;

(22) Filed: **Jan. 17, 2013**

FIG. 2 is a front view of the shredder of FIG. 1;

**Related U.S. Application Data**

(62) Division of application No. 29/407,855, filed on Dec. 2, 2011, now Pat. No. Des. 677,717.

FIG. 3 is a rear view of the shredder of FIG. 1;

(51) **LOC (9) Cl.** ..... **18-04**

(52) **U.S. Cl.**  
USPC ..... **D18/34.5**

FIG. 4 is a left profile view of the shredder of FIG. 1;

(58) **Field of Classification Search**  
USPC ..... D18/34.3, 34.4, 34.5, 34.6, 34.9;  
D23/356, 359, 360, 364; 241/100, 236, 30,  
241/36

FIG. 5 is a right profile view of the shredder of FIG. 1;

See application file for complete search history.

FIG. 6 is a top view of the shredder of FIG. 1;

FIG. 7 is a bottom view of the shredder of FIG. 1;

FIG. 8 is a perspective view of a shredder embodying a second aspect of the design;

FIG. 9 is a front view of the shredder of FIG. 8;

FIG. 10 is a rear view of the shredder of FIG. 8;

FIG. 11 is a left profile view of the shredder of FIG. 8;

FIG. 12 is a right profile view of the shredder of FIG. 8;

FIG. 13 is a top view of the shredder of FIG. 8; and,

FIG. 14 is a bottom view of the shredder of FIG. 8.

The broken lines immediately adjacent the claimed areas, encompassing unshaded regions, represent the bounds of the claimed design while all other broken lines are directed to environment and are for illustrative purposes only; the broken lines form no part of the claimed design.

(56) **References Cited**

**U.S. PATENT DOCUMENTS**

D502,961 S 3/2005 Lo  
D598,048 S 8/2009 Holderfield et al.  
D602,074 S 10/2009 Holderfield et al.

**1 Claim, 14 Drawing Sheets**

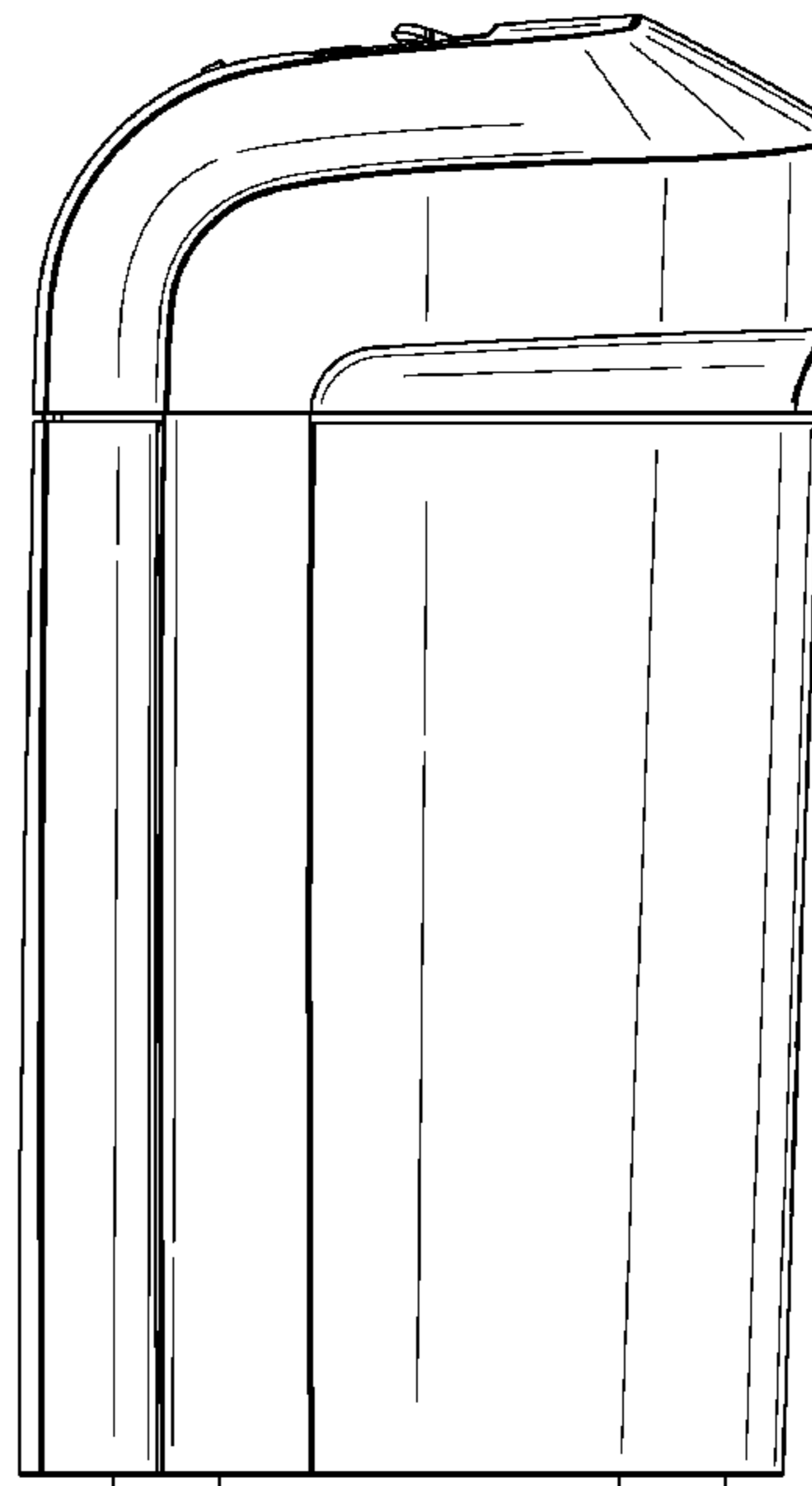
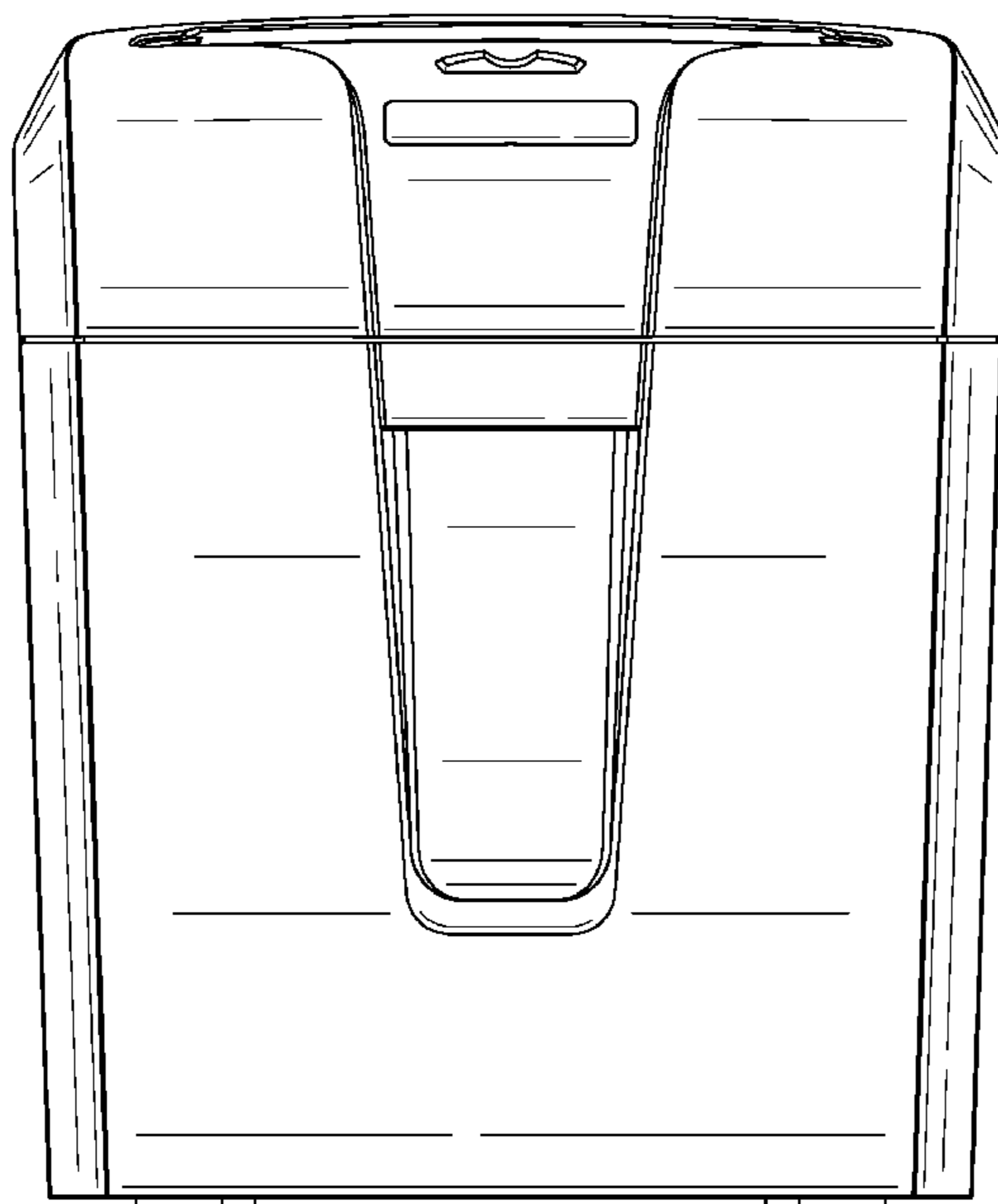

# US D688,740 S

Page 2

---

(56)

## References Cited

### U.S. PATENT DOCUMENTS

7,762,486 B2 7/2010 Mussig et al.  
D643,461 S 8/2011 Kim et al.

D660,345 S 5/2012 Horvath et al.  
D660,907 S 5/2012 Wing et al.  
D677,717 S \* 3/2013 Applegate et al. .... D18/34.5  
2006/0021982 A1 2/2006 Marlin et al.

\* cited by examiner

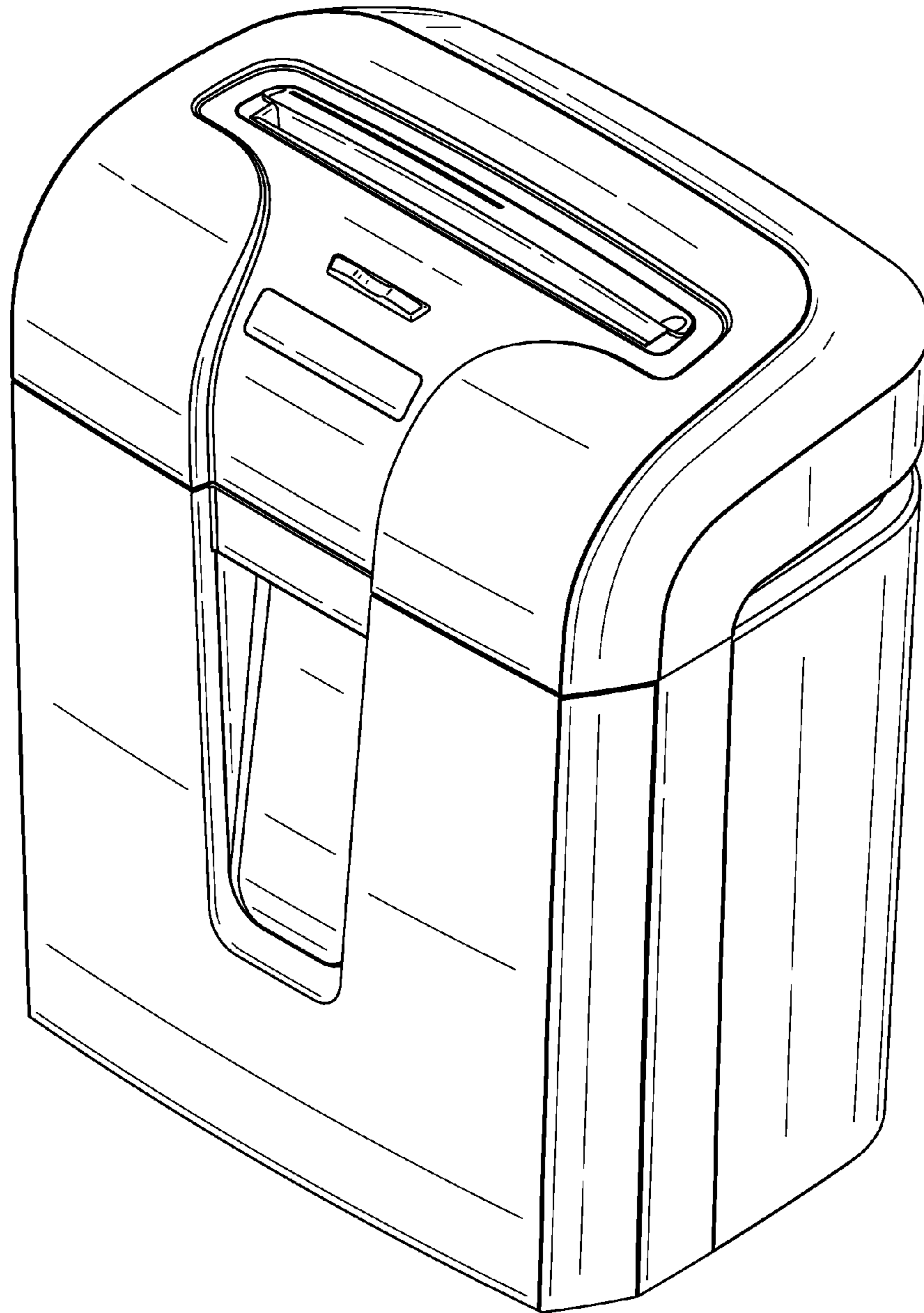

FIG. 1

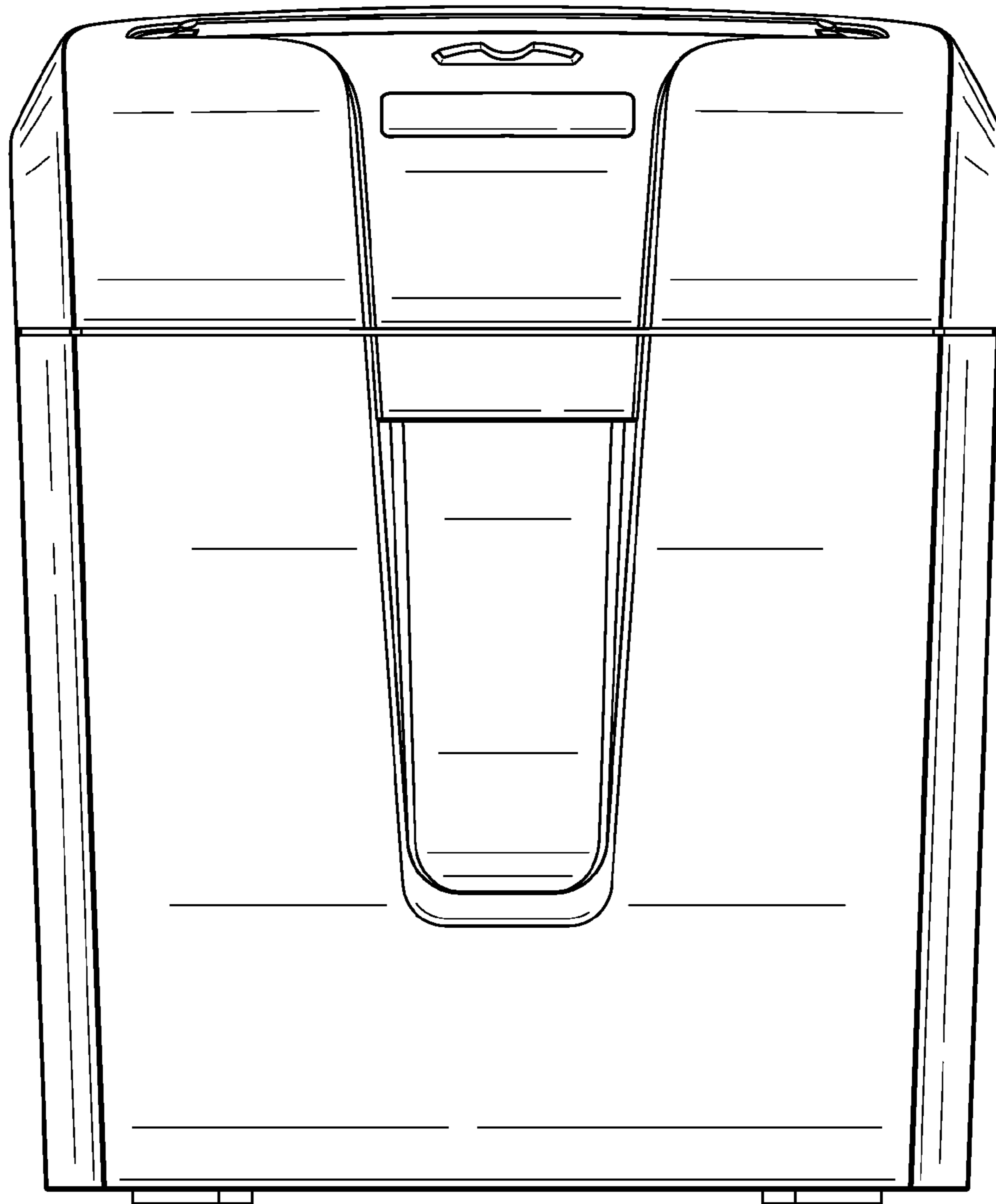

FIG. 2

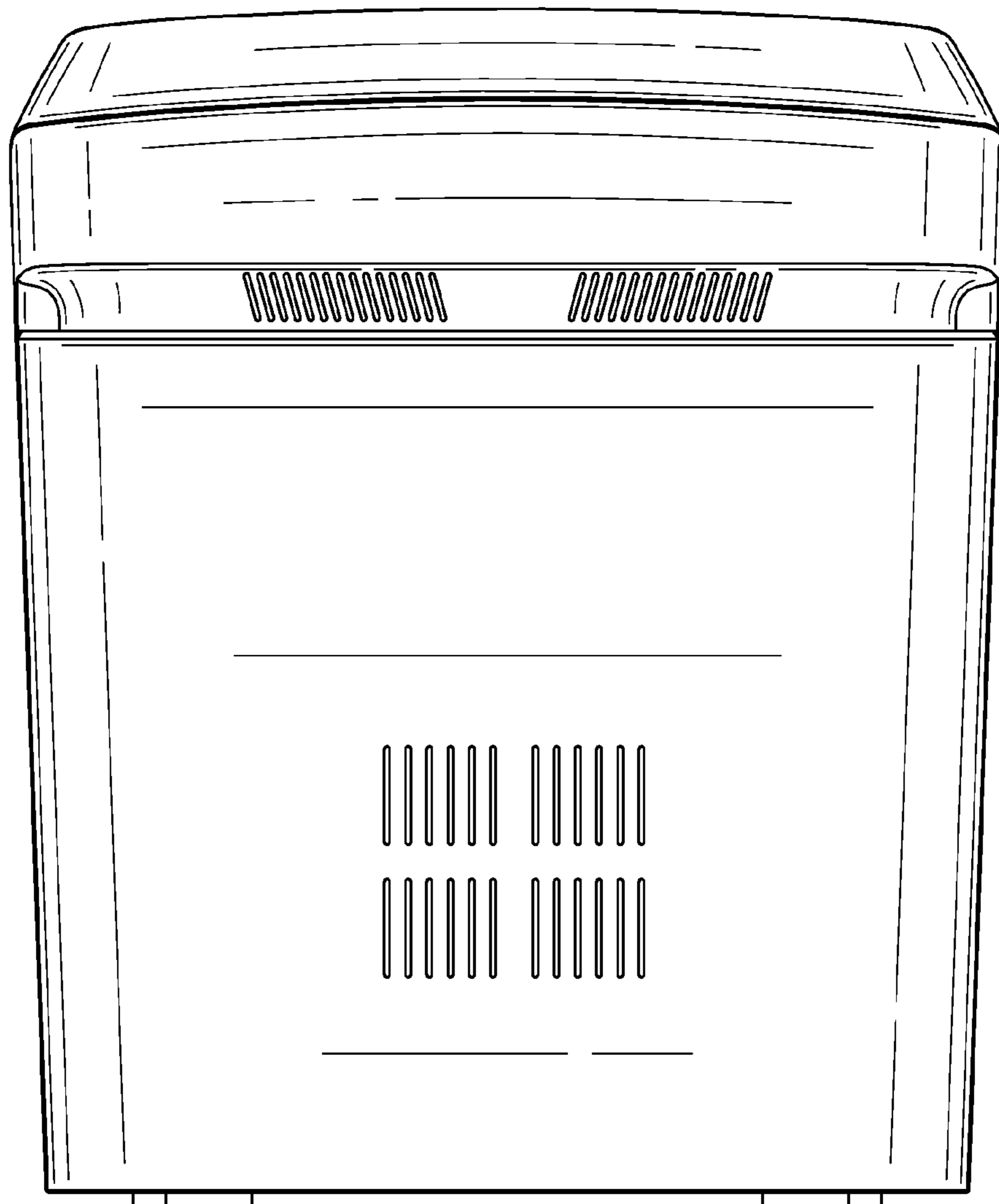

FIG. 3

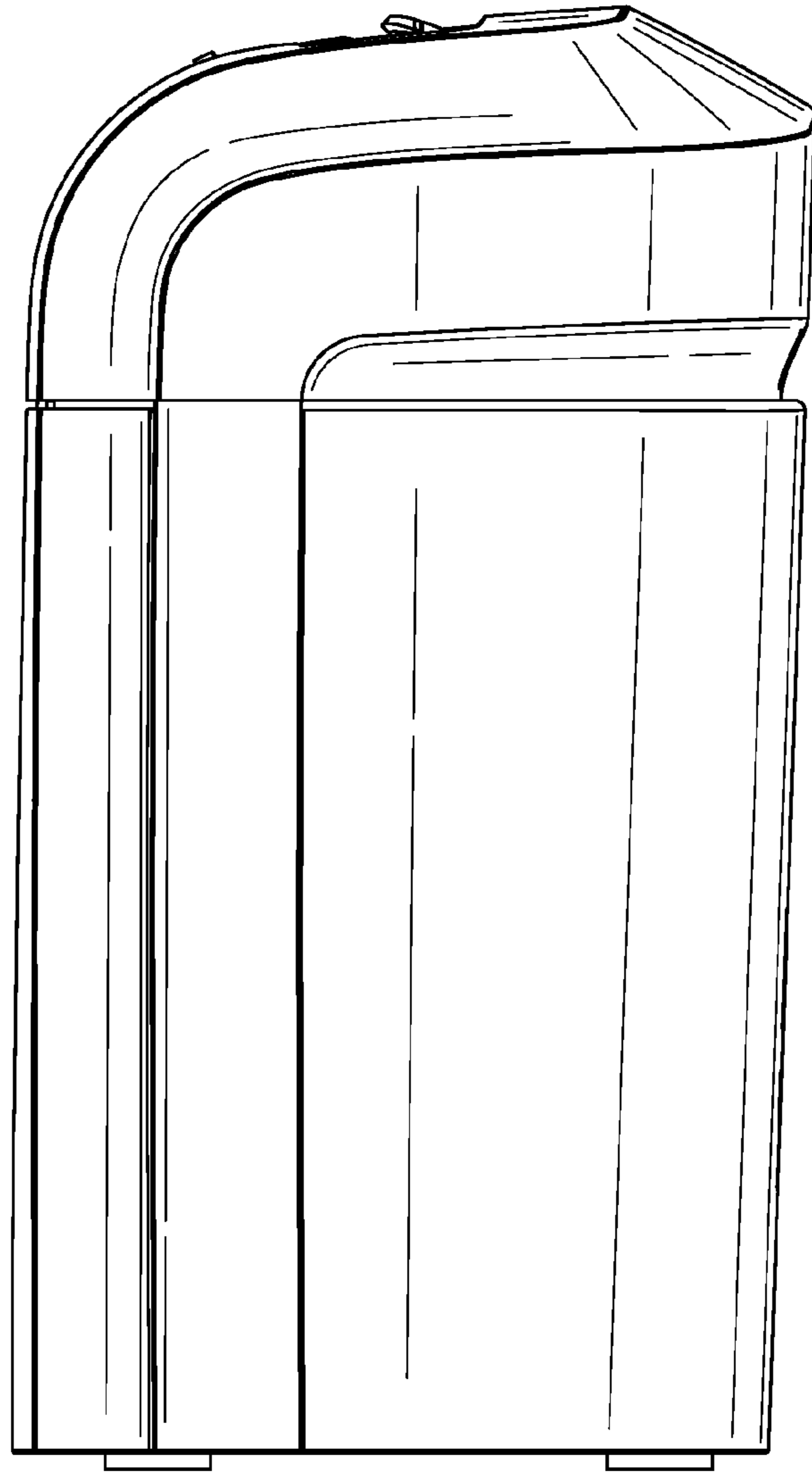

FIG. 4

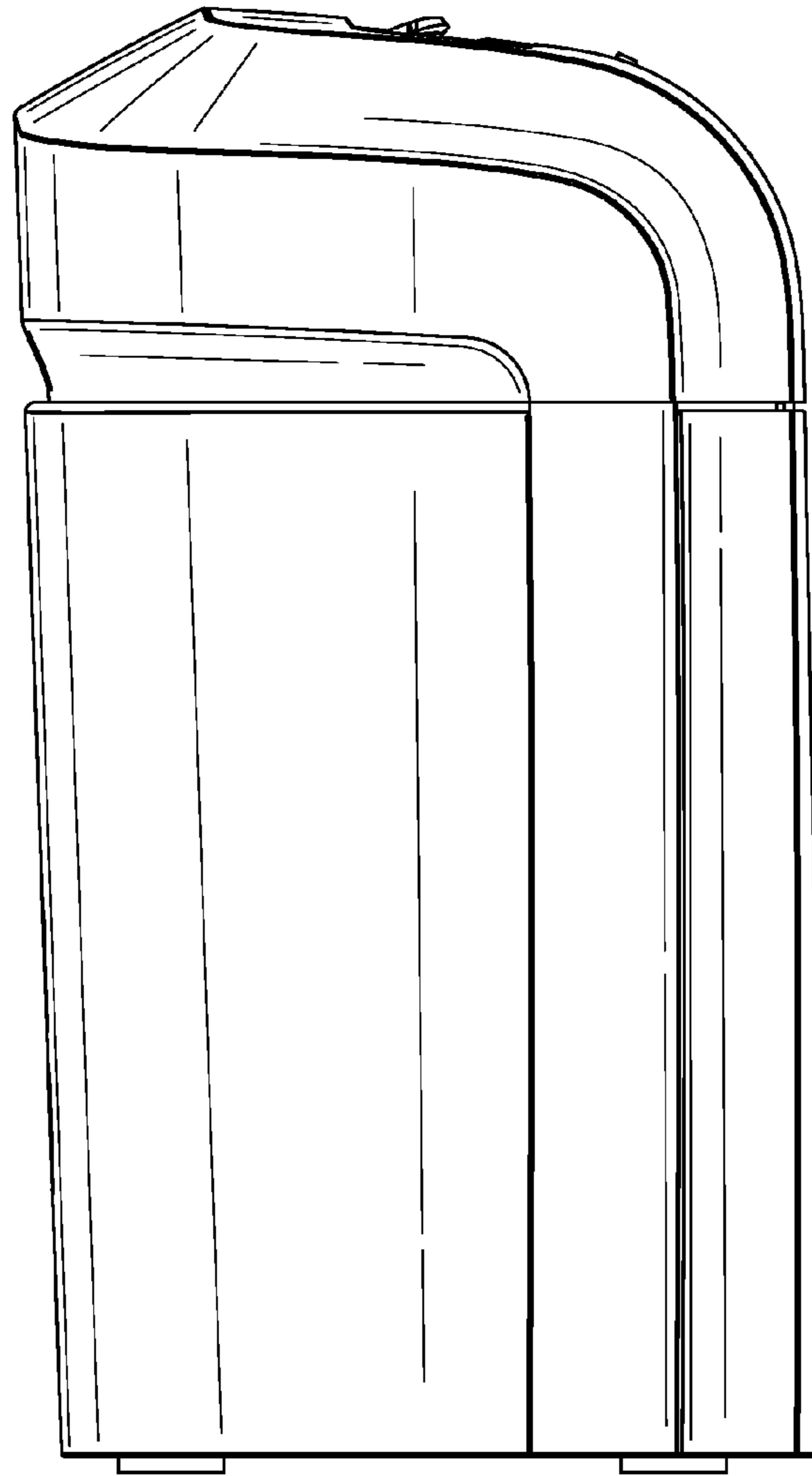

FIG. 5

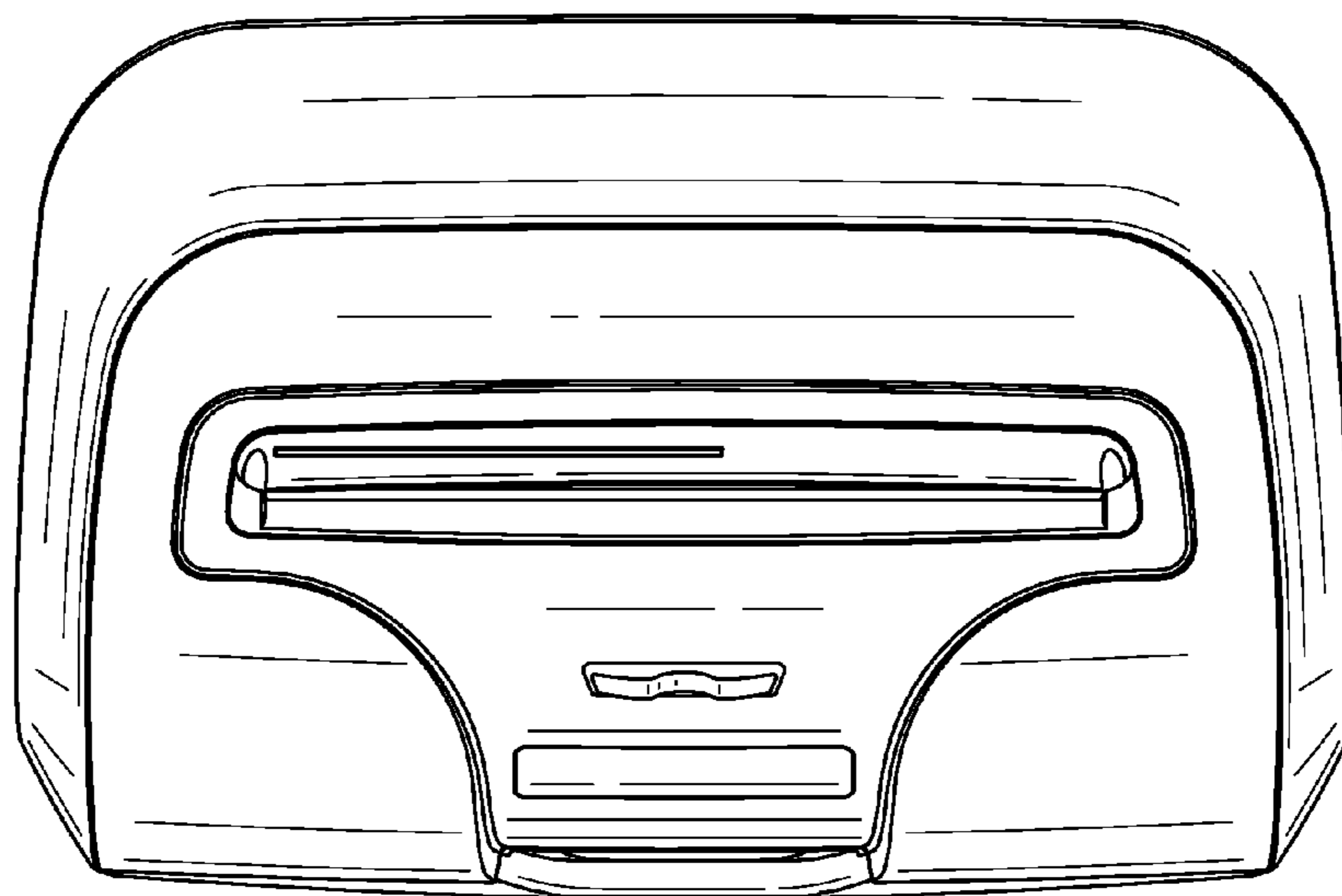

FIG. 6



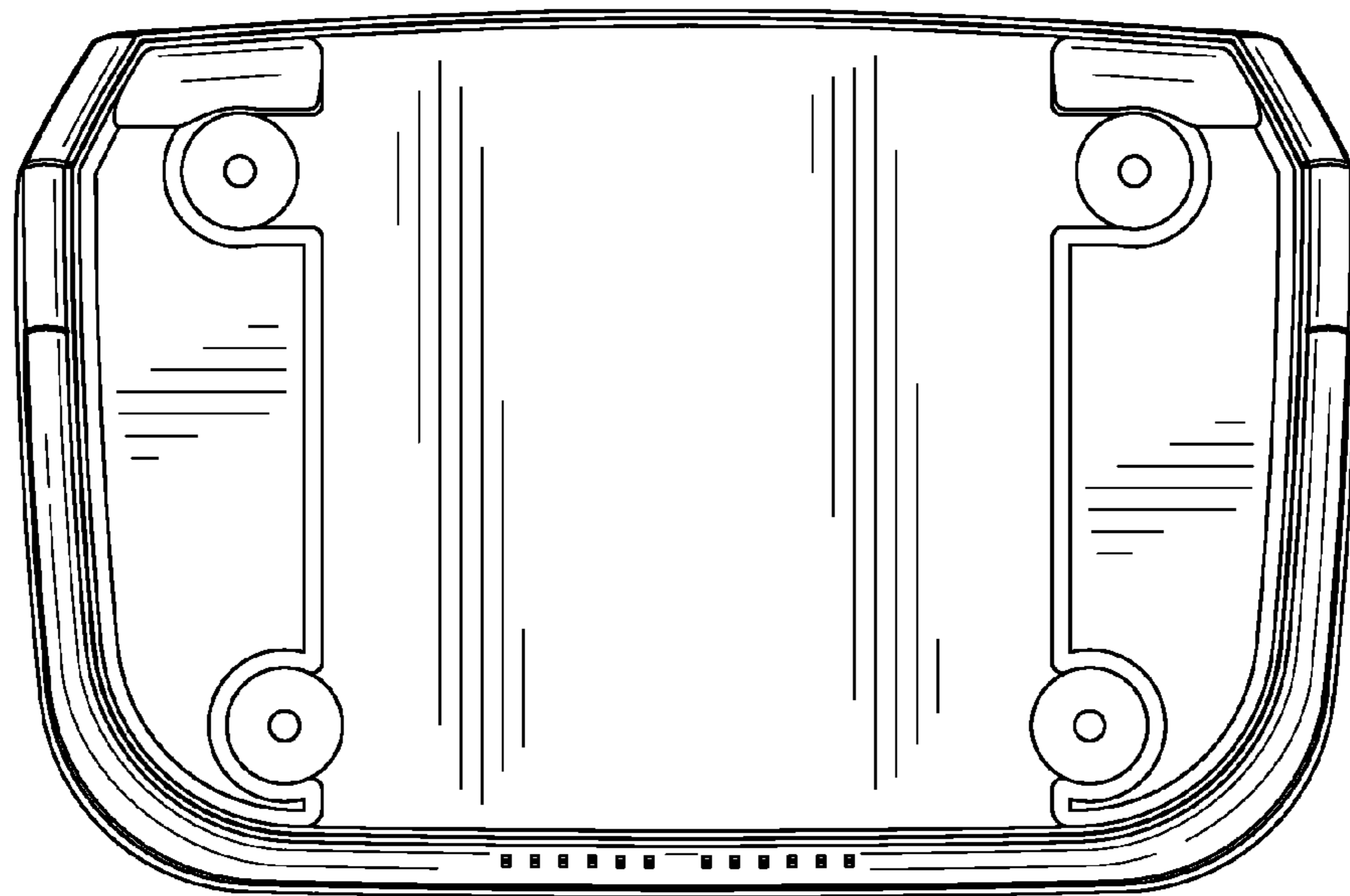

FIG. 7

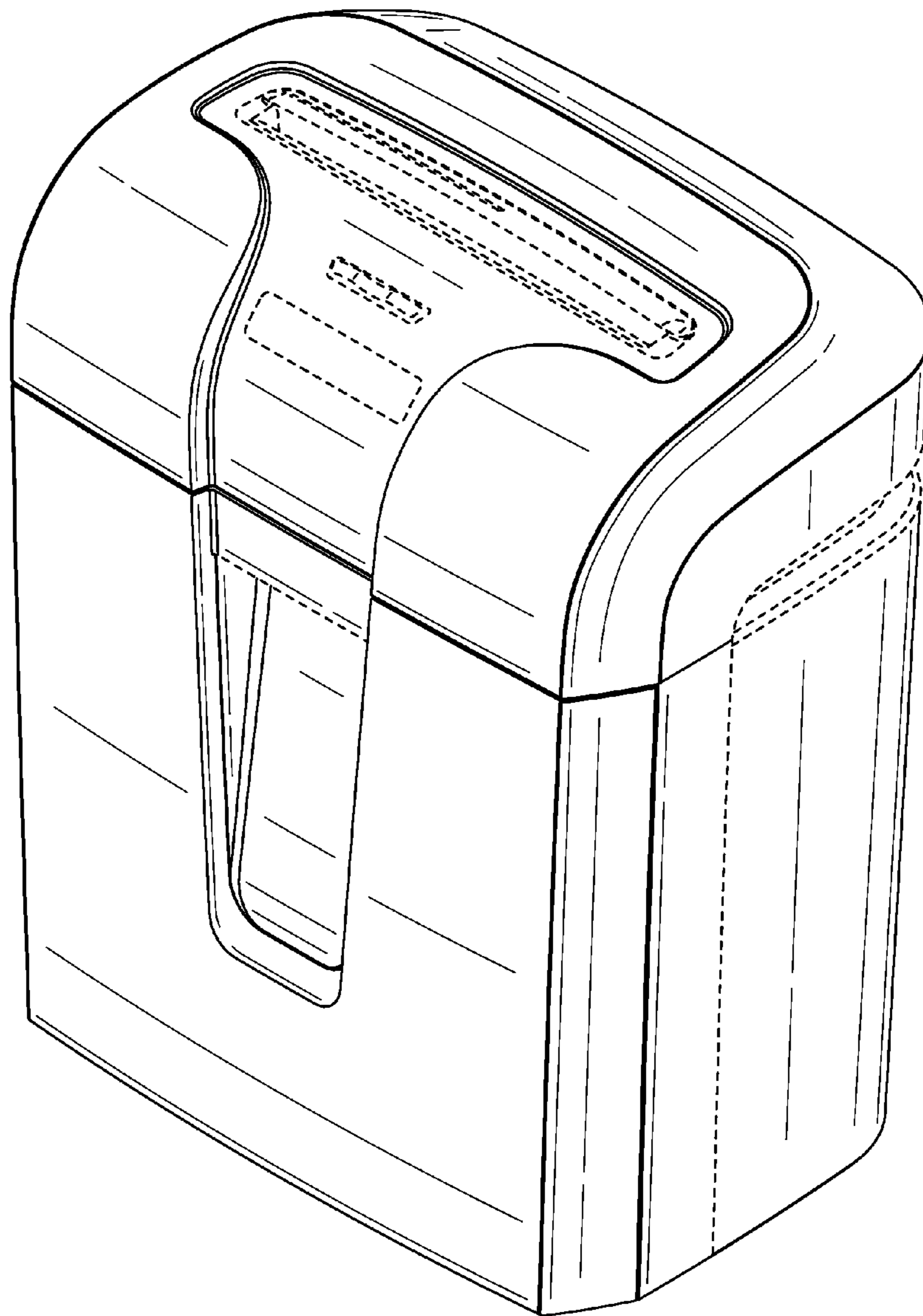

FIG. 8

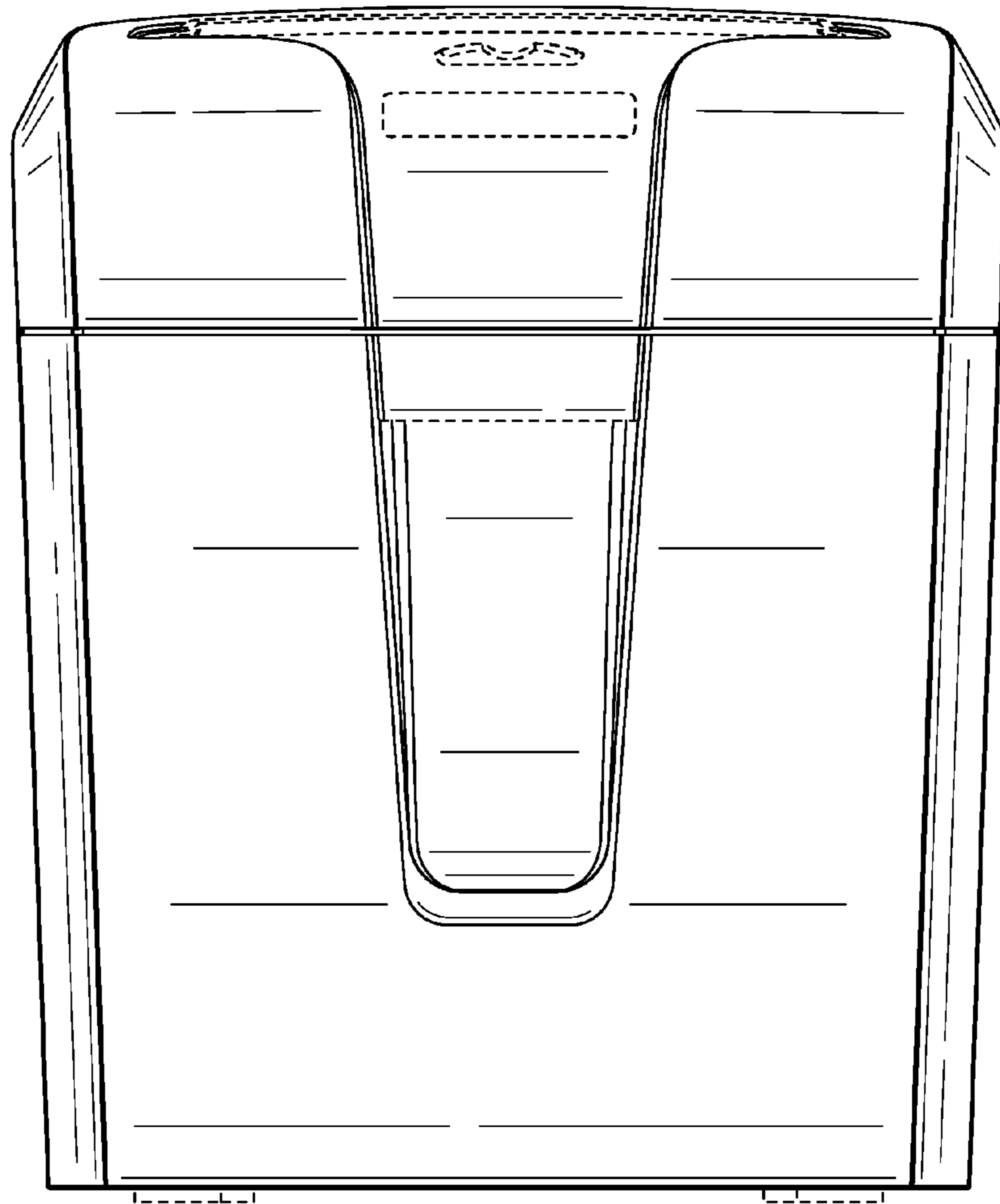

FIG. 9

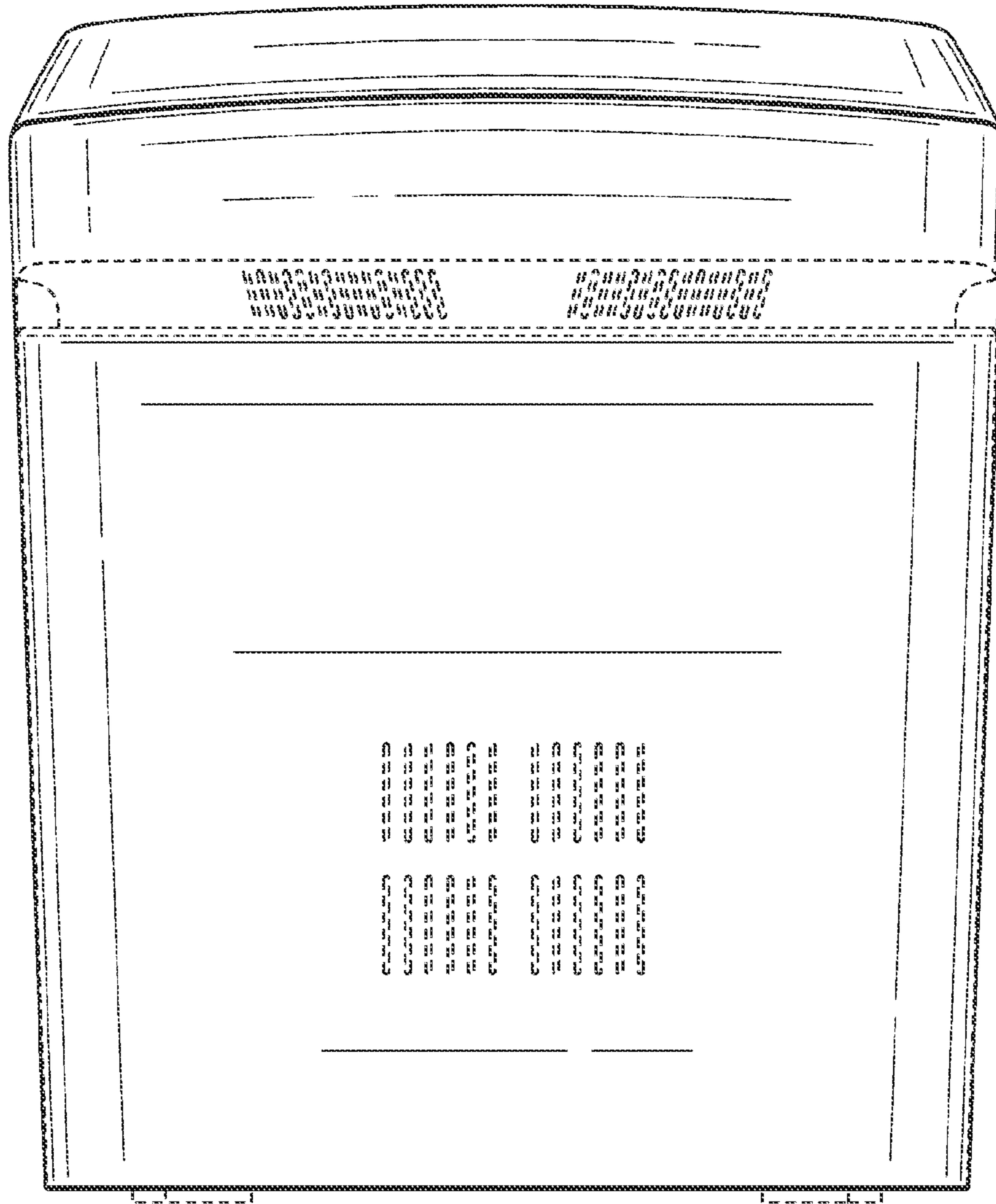

FIG. 10

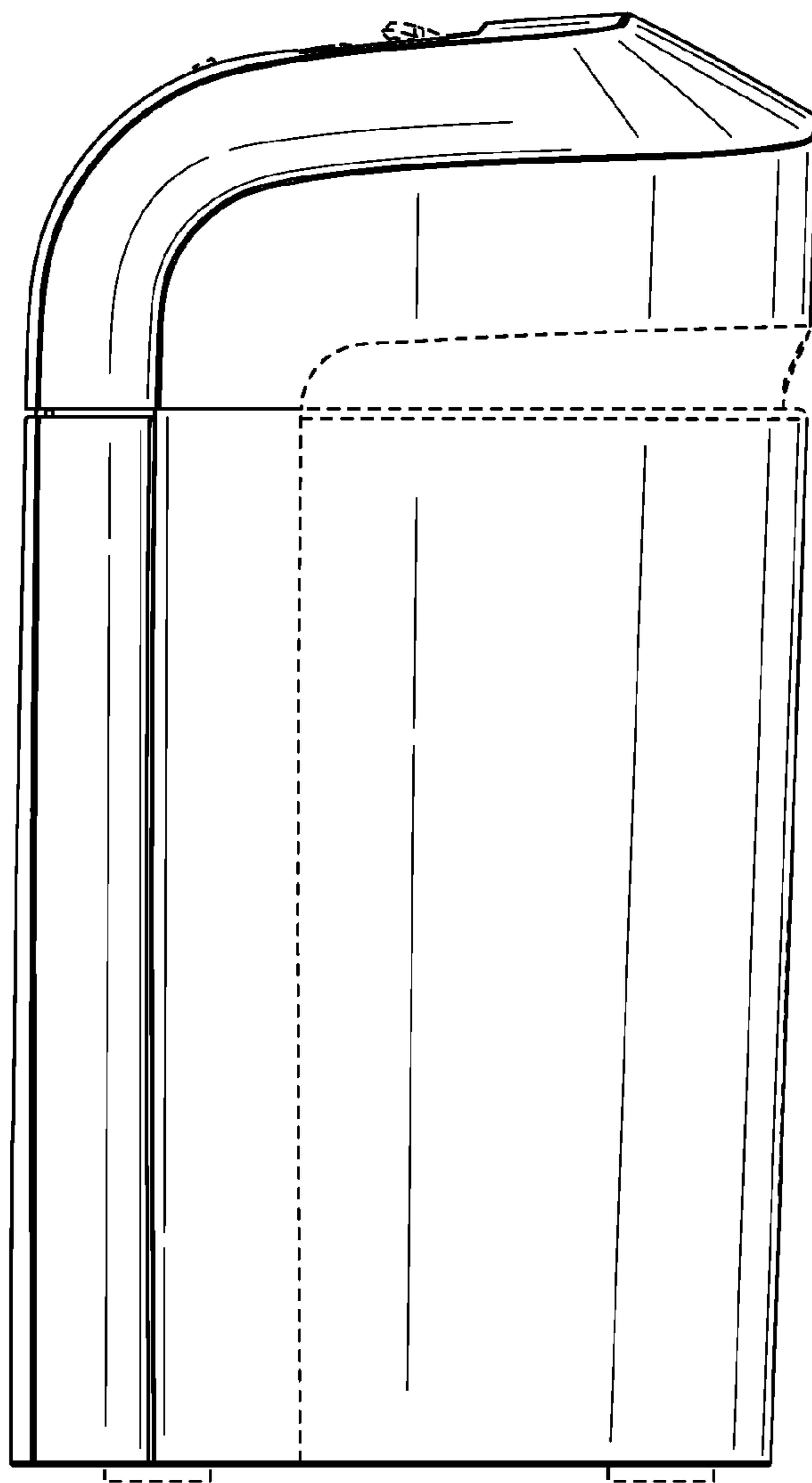

FIG. 11

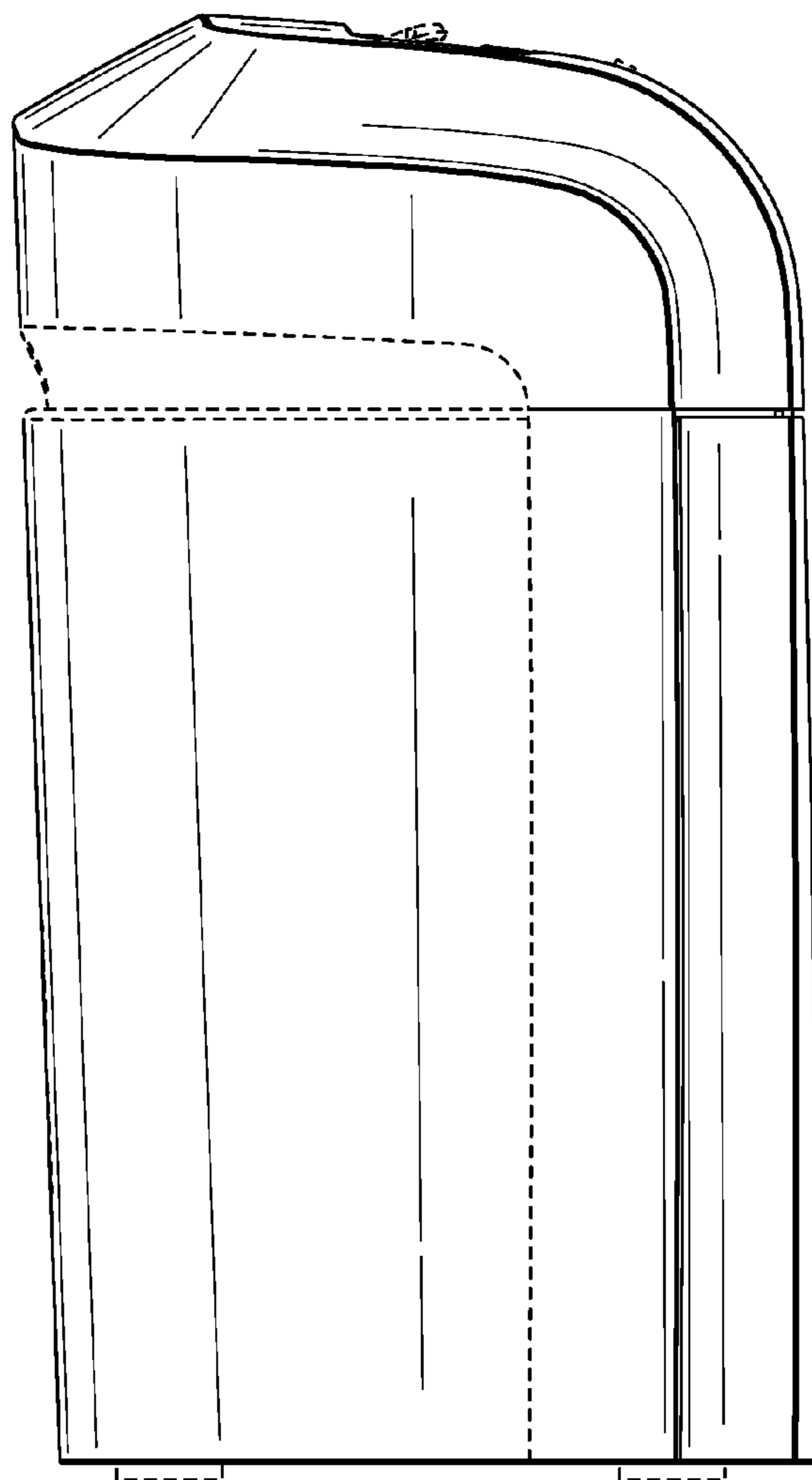

FIG. 12

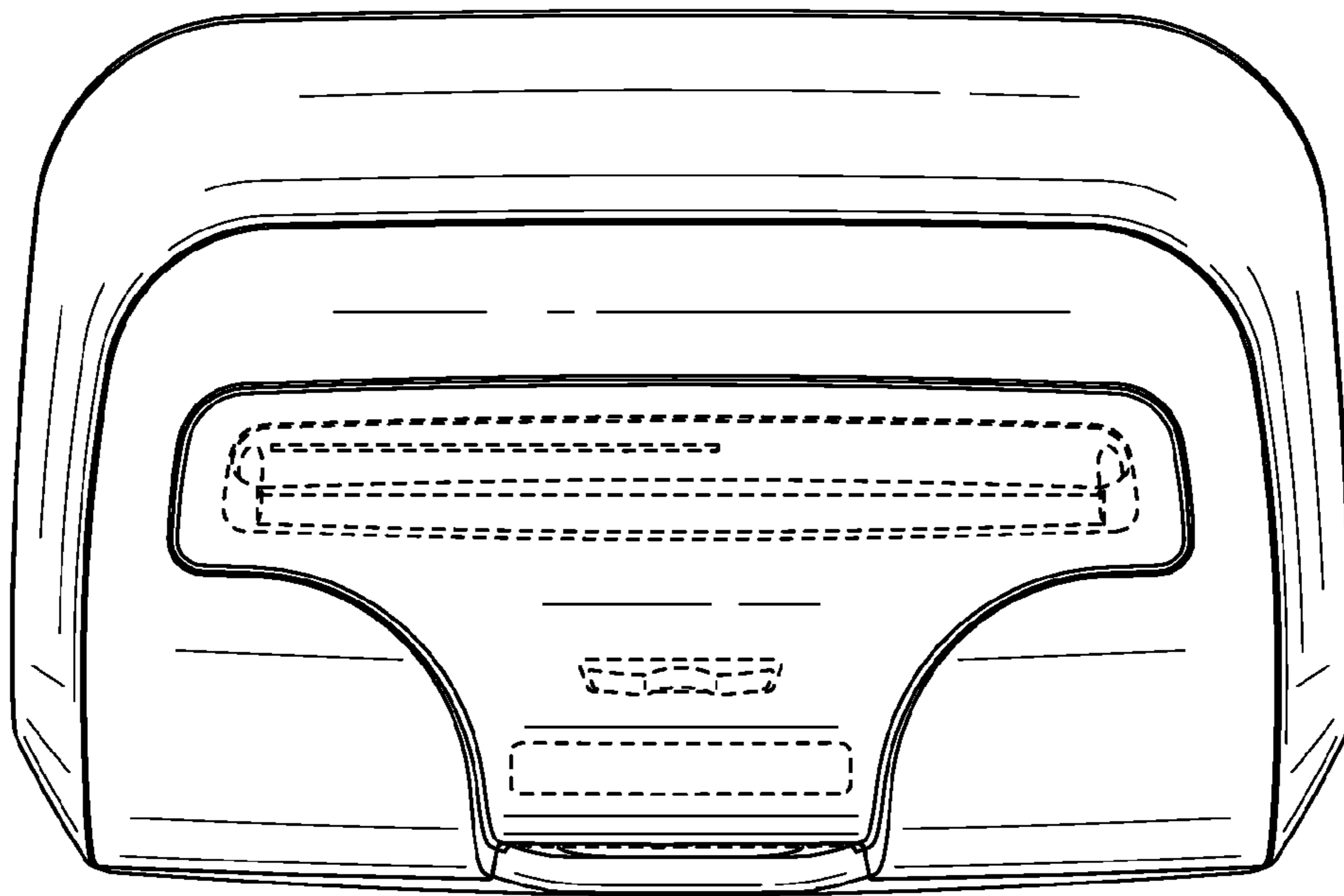

FIG. 13

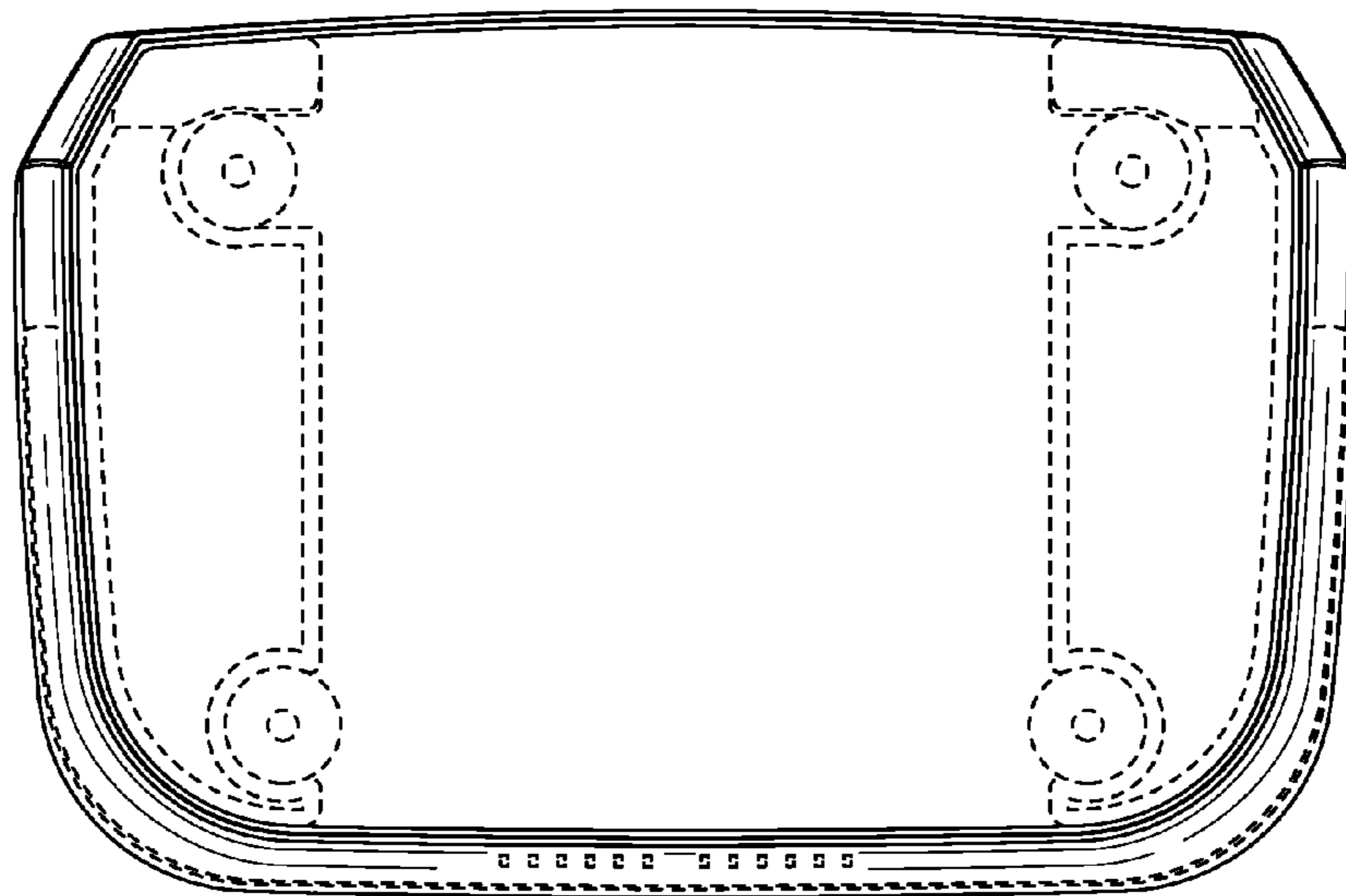

FIG. 14