



US00D688690S

(12) **United States Design Patent**
Garn et al.

(10) **Patent No.:** **US D688,690 S**

(45) **Date of Patent:** **** Aug. 27, 2013**

(54) **DISPLAY SCREEN WITH AN ANIMATED GRAPHICAL USER INTERFACE**

(75) Inventors: **Jonathan D. Garn**, North Bend, WA (US); **Jonathan Randall Morris**, Redmond, WA (US); **Yee Shian Lee**, San Diego, CA (US); **Luis Cabrera-Cordon**, Bothell, WA (US)

(73) Assignee: **Microsoft Corporation**, Redmond, WA (US)

(**) Term: **14 Years**

(21) Appl. No.: **29/396,526**

(22) Filed: **Jun. 30, 2011**

(51) **LOC (9) Cl.** **14-04**

(52) **U.S. Cl.**
USPC **D14/488**

(58) **Field of Classification Search**
USPC D14/485-95; D18/24-33; D19/6, D19/52; D20/11; D21/324-33; 715/700-867, 715/973-77

See application file for complete search history.

(56) **References Cited**

U.S. PATENT DOCUMENTS

D384,050	S	*	9/1997	Kodosky	D14/490
D384,052	S	*	9/1997	Kodosky	D14/490
D387,047	S	*	12/1997	Yamamoto et al.	D14/493
5,706,097	A	*	1/1998	Schelling et al.	358/296
D396,709	S	*	8/1998	Bier	D14/493
D398,300	S	*	9/1998	Yamamoto et al.	D14/493
D434,422	S	*	11/2000	Thomas et al.	D14/493
6,583,800	B1	*	6/2003	Ridgley et al.	715/854
D513,511	S	*	1/2006	Decombe	D14/486
D522,529	S	*	6/2006	Gibson	D14/489
D532,015	S	*	11/2006	Lindsay et al.	D14/488
D533,182	S	*	12/2006	McDougall et al.	D14/485
7,185,056	B2	*	2/2007	Fujisawa et al.	709/205

D565,060	S	*	3/2008	Lettau et al.	D14/493
D570,863	S	*	6/2008	Chen et al.	D14/486
D572,722	S	*	7/2008	Guimaraes et al.	D14/493
D593,125	S	*	5/2009	Danton	D14/489
D593,128	S	*	5/2009	Danton	D14/492
7,533,186	B2	*	5/2009	Raman	709/239
D596,193	S	*	7/2009	Shotel	D14/486
D599,365	S	*	9/2009	Brown et al.	D14/485
D599,806	S	*	9/2009	Brown et al.	D14/485
D611,053	S	*	3/2010	Kanga et al.	D14/485
D614,640	S	*	4/2010	Viegers et al.	D14/486
D616,895	S	*	6/2010	Ehrler et al.	D14/486
D619,146	S	*	7/2010	Flik et al.	D14/493
D620,024	S	*	7/2010	Dunn et al.	D14/493
7,777,789	B2	*	8/2010	Shibuya et al.	348/231.2
7,827,507	B2	*	11/2010	Geise et al.	715/850
7,844,987	B2	*	11/2010	Kelts	725/44
D629,411	S	*	12/2010	Weir et al.	D14/485

(Continued)

Primary Examiner — Melanie H Tung

(74) *Attorney, Agent, or Firm* — Banner & Witcoff, Ltd.

(57) **CLAIM**

The ornamental design for a display screen with an animated graphical user interface, as shown and described.

DESCRIPTION

FIG. 1 is the first image in a sequence for a display screen with an animated graphical user interface showing the new design; FIG. 2 is the second image thereof; FIG. 3 is the third image thereof; FIG. 4 is the fourth image thereof; FIG. 5 is the fifth image thereof; and, FIG. 6 is the sixth image thereof. The appearance of the image transitions sequentially between the images shown in FIGS. 1-6, the process or period in which an image transitions to another forms no part of the claimed design. The broken line showing of the rectangle, circles and the display screen is for environmental purposes only and forms no part of the claimed design.

1 Claim, 6 Drawing Sheets

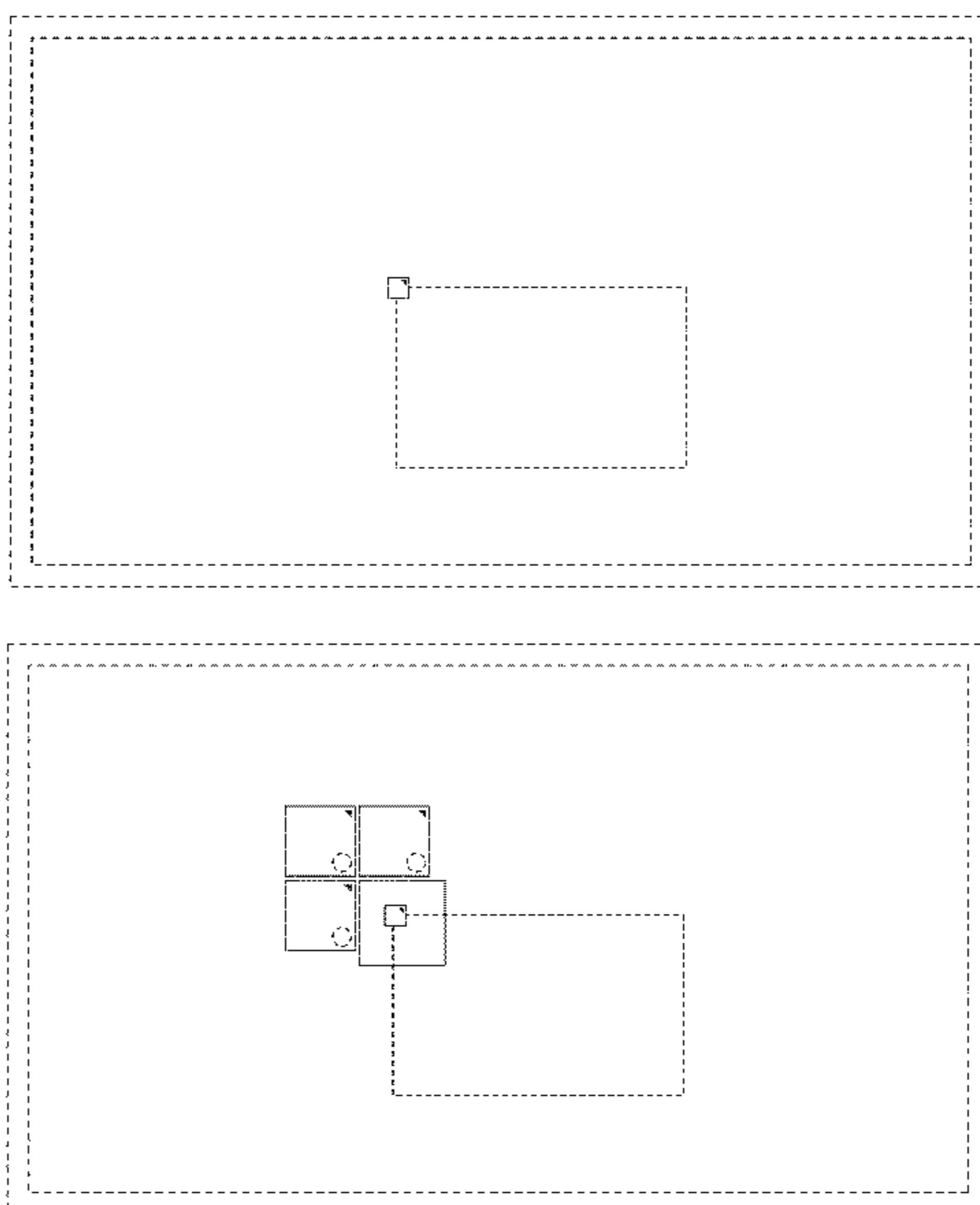

(56)

References Cited

U.S. PATENT DOCUMENTS

D629,814 S * 12/2010 Lew D14/492
7,861,181 B2 * 12/2010 Kaminsky et al. 715/765
D637,604 S * 5/2011 Brinda D14/488
D640,269 S * 6/2011 Chen D14/487
D642,196 S * 7/2011 Fong et al. D14/492

D651,608 S * 1/2012 Allen et al. D14/485
D651,609 S * 1/2012 Pearson et al. D14/486
D656,953 S * 4/2012 Knudsen et al. D14/489
D659,153 S * 5/2012 Thoresson et al. D14/486
8,205,172 B2 * 6/2012 Wong et al. 715/855
8,209,609 B2 * 6/2012 Dunton et al. 715/716
D670,720 S * 11/2012 Garn et al. D14/486

* cited by examiner

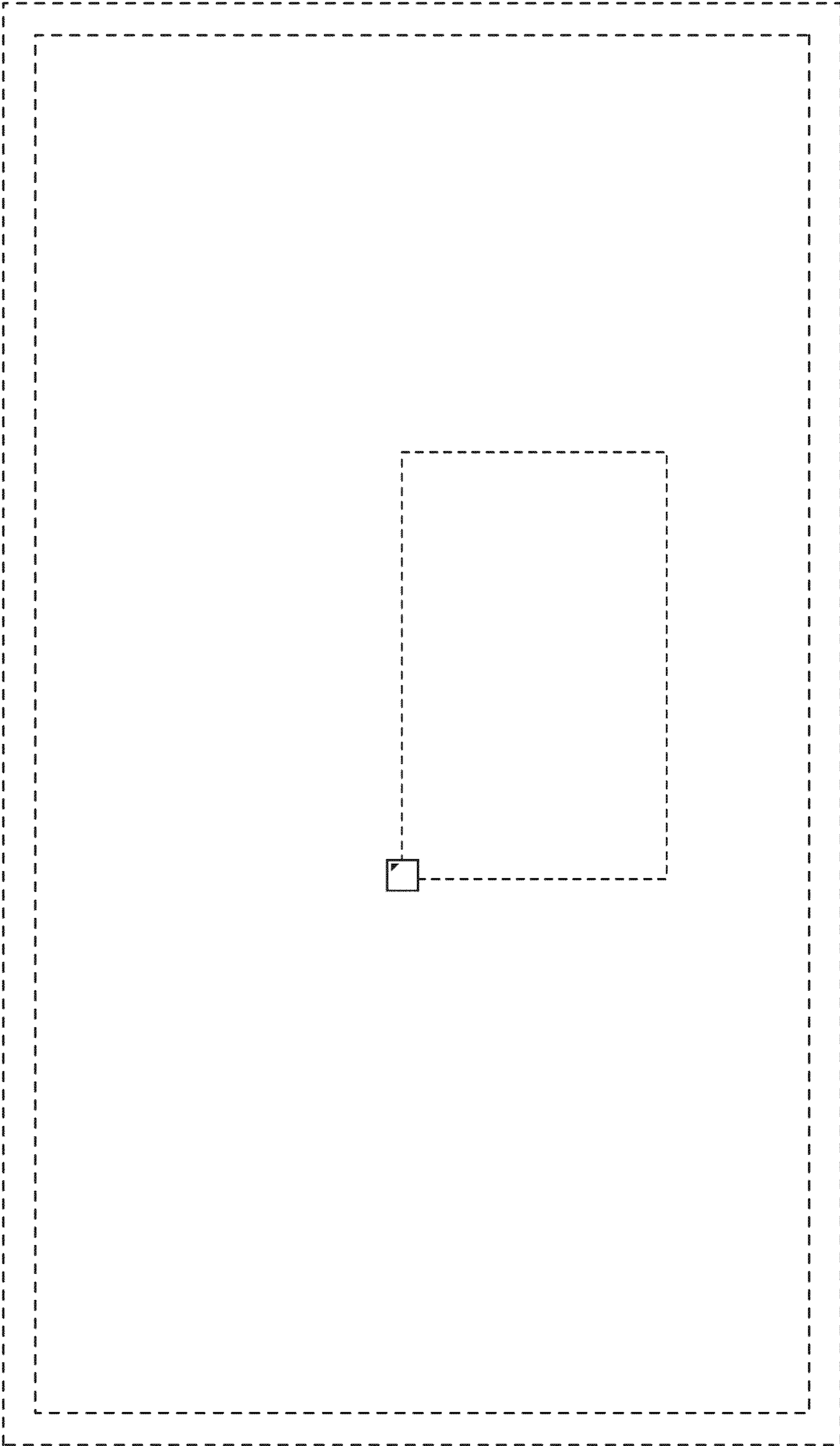

FIG. 1

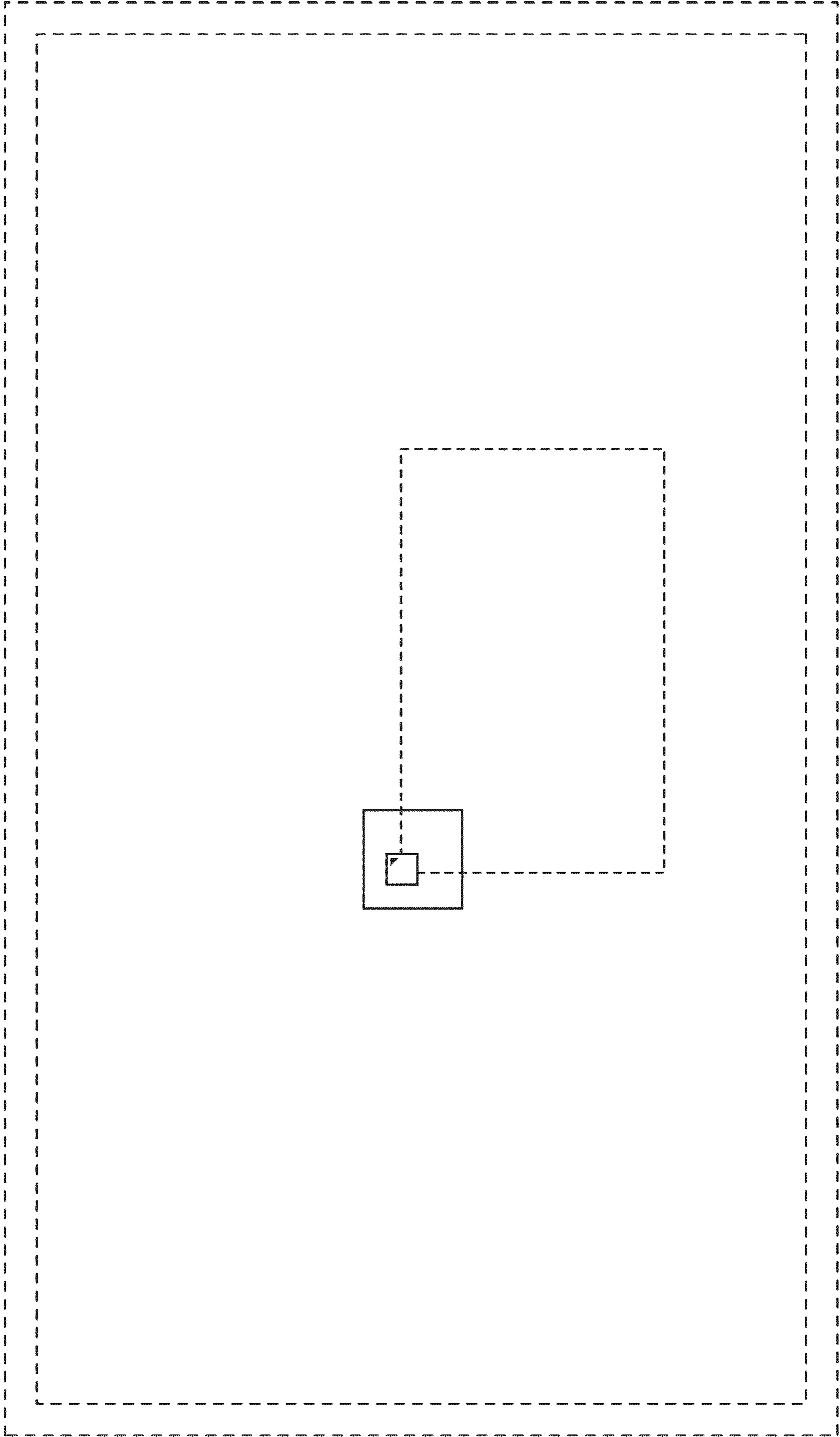

FIG. 2

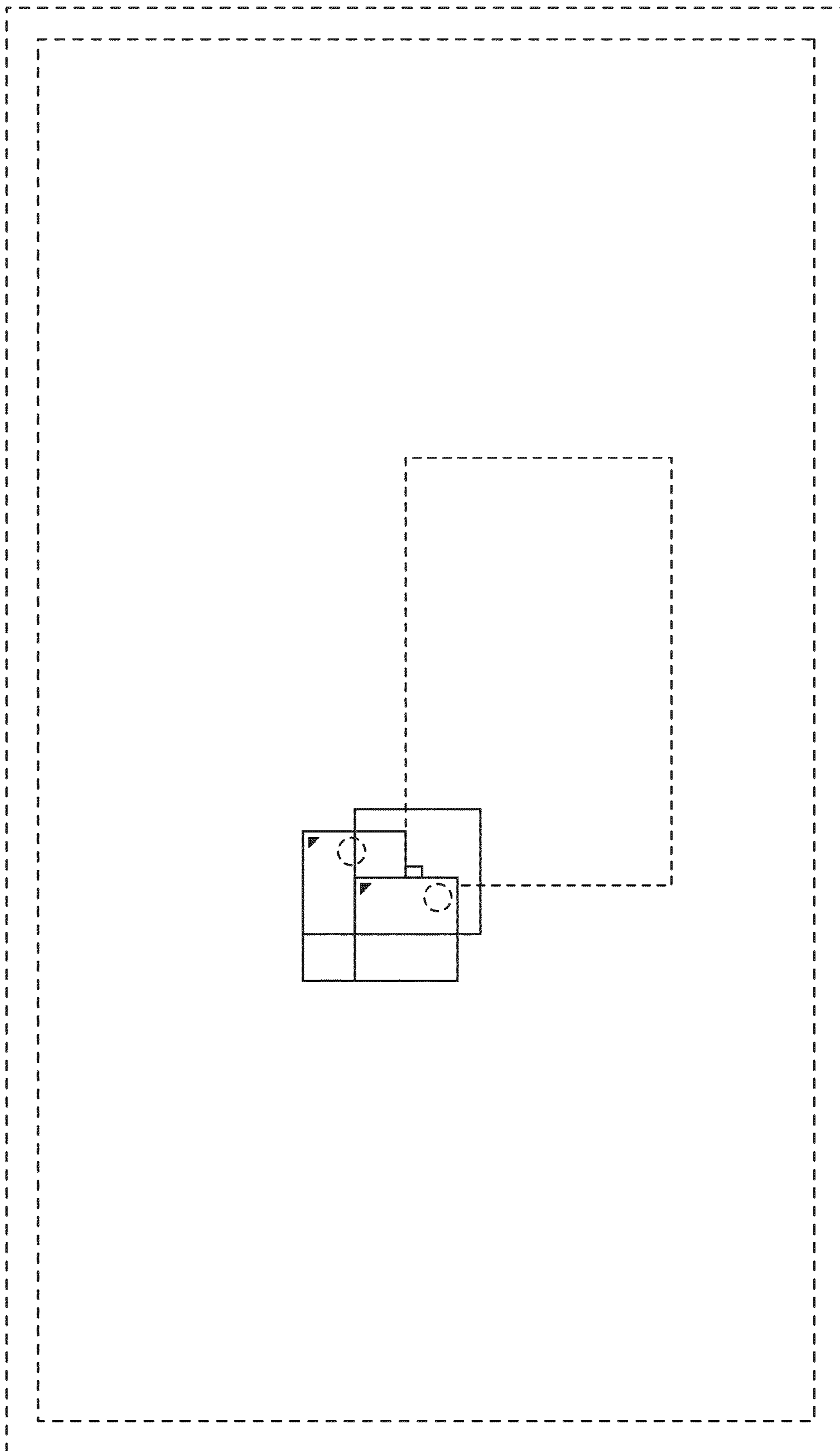

FIG. 3

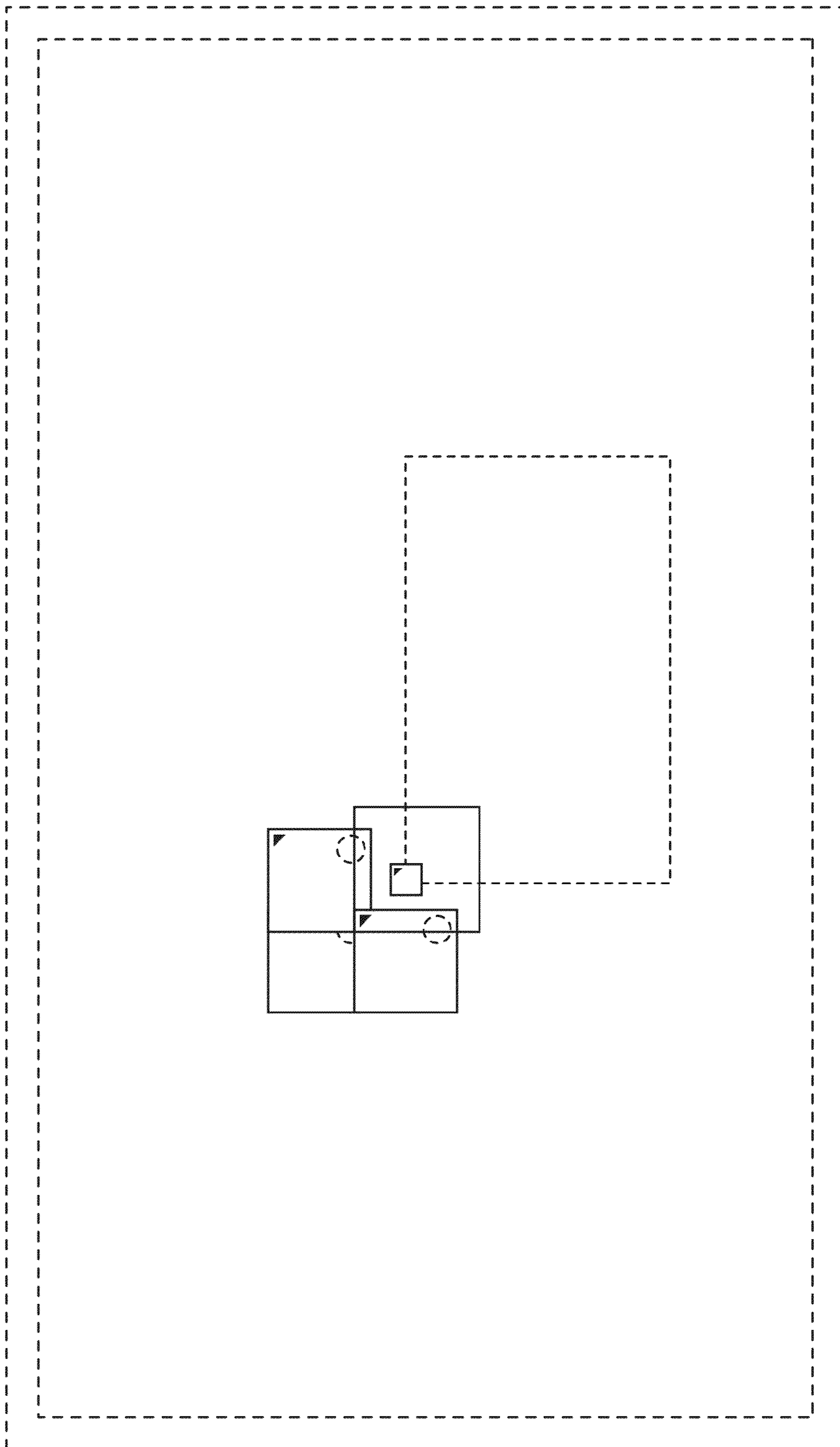

FIG. 4

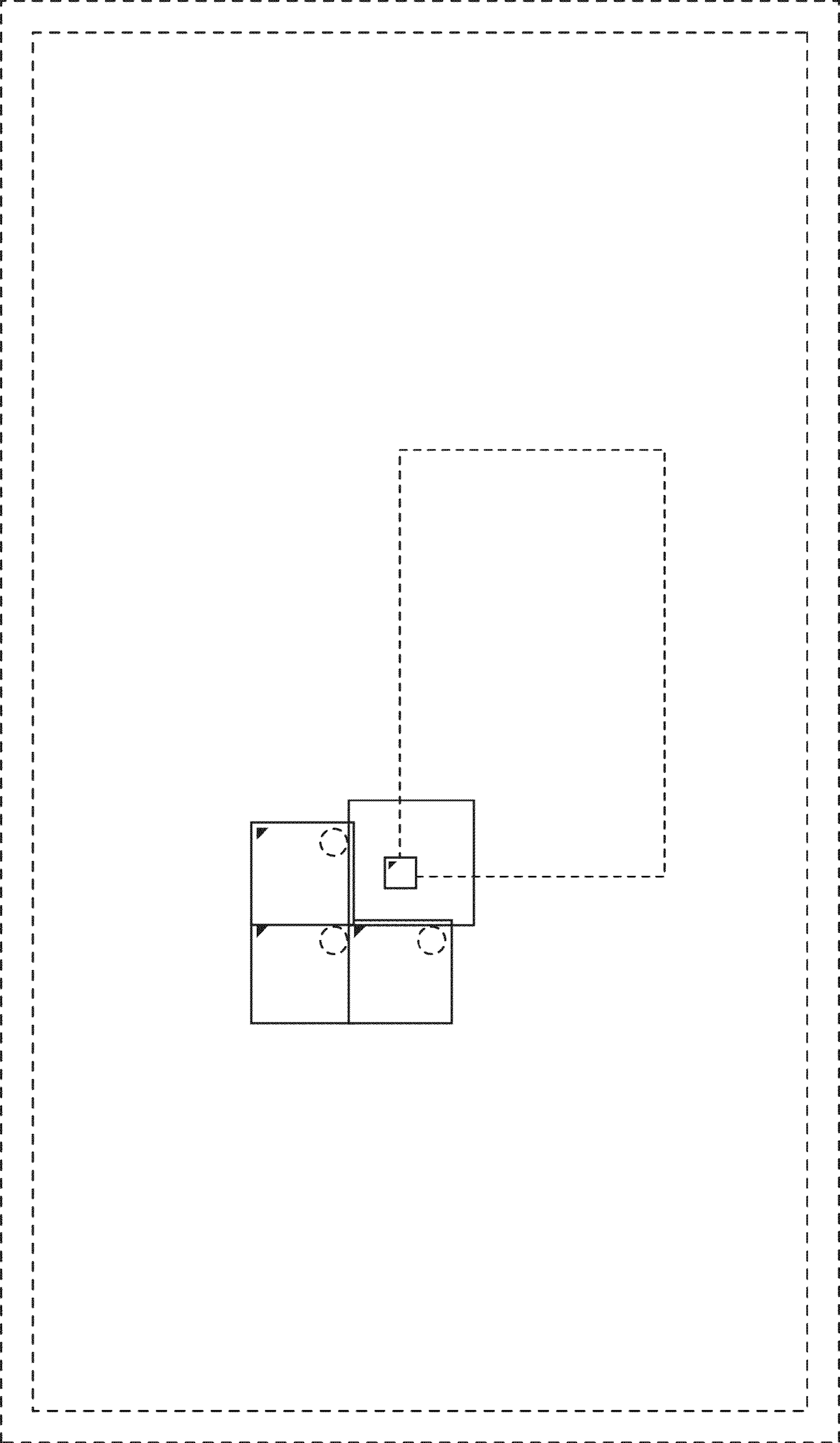

FIG. 5

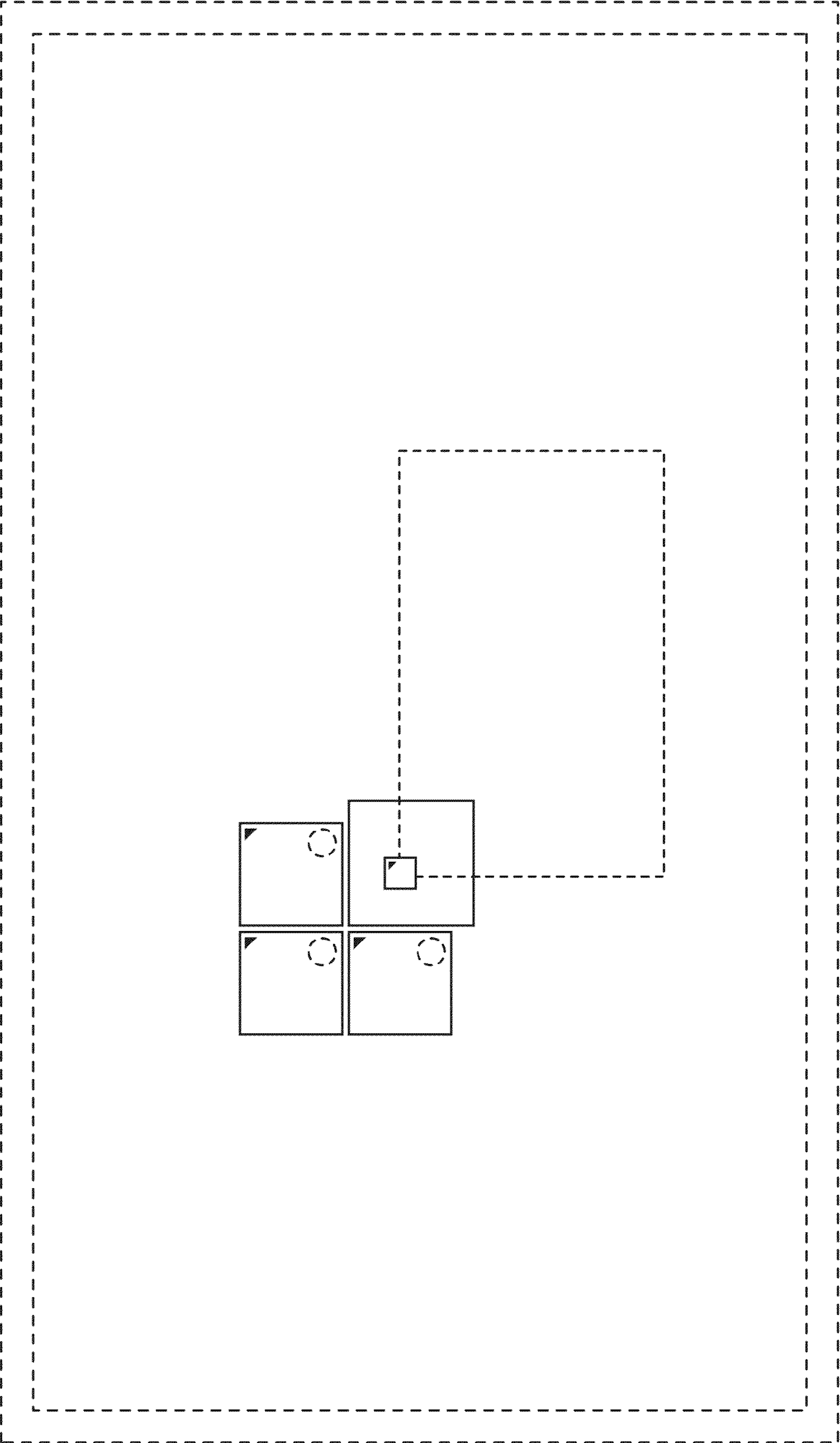

FIG. 6