



US00D688680S

(12) **United States Design Patent**  
**Fleischmann et al.**

(10) **Patent No.:** **US D688,680 S**

(45) **Date of Patent:** **\*\* \*Aug. 27, 2013**

(54) **DISPLAY SCREEN WITH ANIMATED GRAPHICAL USER INTERFACE**

(75) Inventors: **Jeff Fleischmann**, Seattle, WA (US);  
**David Gardner**, Covington, WA (US);  
**Salvador Alucema**, Seattle, WA (US);  
**Colin Riley**, Seattle, WA (US)

(73) Assignee: **Microsoft Corporation**, Redmond, WA (US)

(\*) Notice: This patent is subject to a terminal disclaimer.

(\*\*) Term: **14 Years**

(21) Appl. No.: **29/407,616**

(22) Filed: **Nov. 30, 2011**

(51) **LOC (9) Cl.** ..... **14-02**

(52) **U.S. Cl.**  
USPC ..... **D14/486**

(58) **Field of Classification Search**  
USPC ..... D14/485-495; 715/700-867  
See application file for complete search history.

(56) **References Cited**

U.S. PATENT DOCUMENTS

6,185,476	B1 *	2/2001	Sakai	700/182
6,268,854	B1 *	7/2001	Borden et al.	715/786
D545,828	S	7/2007	Vong et al.	
D546,335	S	7/2007	Vong et al.	
D546,336	S	7/2007	Vong et al.	
D556,767	S *	12/2007	Morris	D14/487
D556,768	S *	12/2007	Morris	D14/487
D556,769	S *	12/2007	Morris	D14/487
D599,363	S	9/2009	Mays	
D599,364	S	9/2009	Mays	
D599,365	S	9/2009	Brown et al.	
D599,366	S	9/2009	Brown et al.	
D599,367	S	9/2009	Mays et al.	
D599,368	S	9/2009	Kanga et al.	
D622,730	S	8/2010	Krum et al.	
D627,361	S	11/2010	Lew et al.	

(Continued)

Primary Examiner — Deanna L Fluegeman

(74) *Attorney, Agent, or Firm* — Banner & Witcoff, Ltd.

(57) **CLAIM**

The ornamental design for a display screen with animated graphical user interface, as shown and described.

**DESCRIPTION**

FIG. 1 is the first image in a sequence for a display screen with animated graphical user interface showing the new design; FIG. 2 is the second image thereof; FIG. 3 is the third image thereof; FIG. 4 is the fourth image thereof; FIG. 5 is the fifth image thereof; FIG. 6 is the sixth image thereof; FIG. 7 is the seventh image thereof; FIG. 8 is the eighth image thereof; FIG. 9 is the ninth image thereof; FIG. 10 is the tenth image thereof; FIG. 11 is the eleventh image thereof; FIG. 12 is the twelfth image thereof; FIG. 13 is the thirteenth image thereof; FIG. 14 is the fourteenth image thereof; FIG. 15 is the fifteenth image thereof; FIG. 16 is the sixteenth image thereof; FIG. 17 is the seventeenth image thereof; FIG. 18 is the eighteenth image thereof; FIG. 19 is the nineteenth image thereof; and, FIG. 20 is the twentieth image thereof.

The appearance of the transitional image sequentially transitions between the images shown in FIGS. 1-20. The process or period in which one image transitions to another image forms no part of the claimed design.

The broken line showing of the squares, rectangles and portions thereof, and of the remainder of the display screen is for environmental purposes only and forms no part of the claimed design.

**1 Claim, 20 Drawing Sheets**

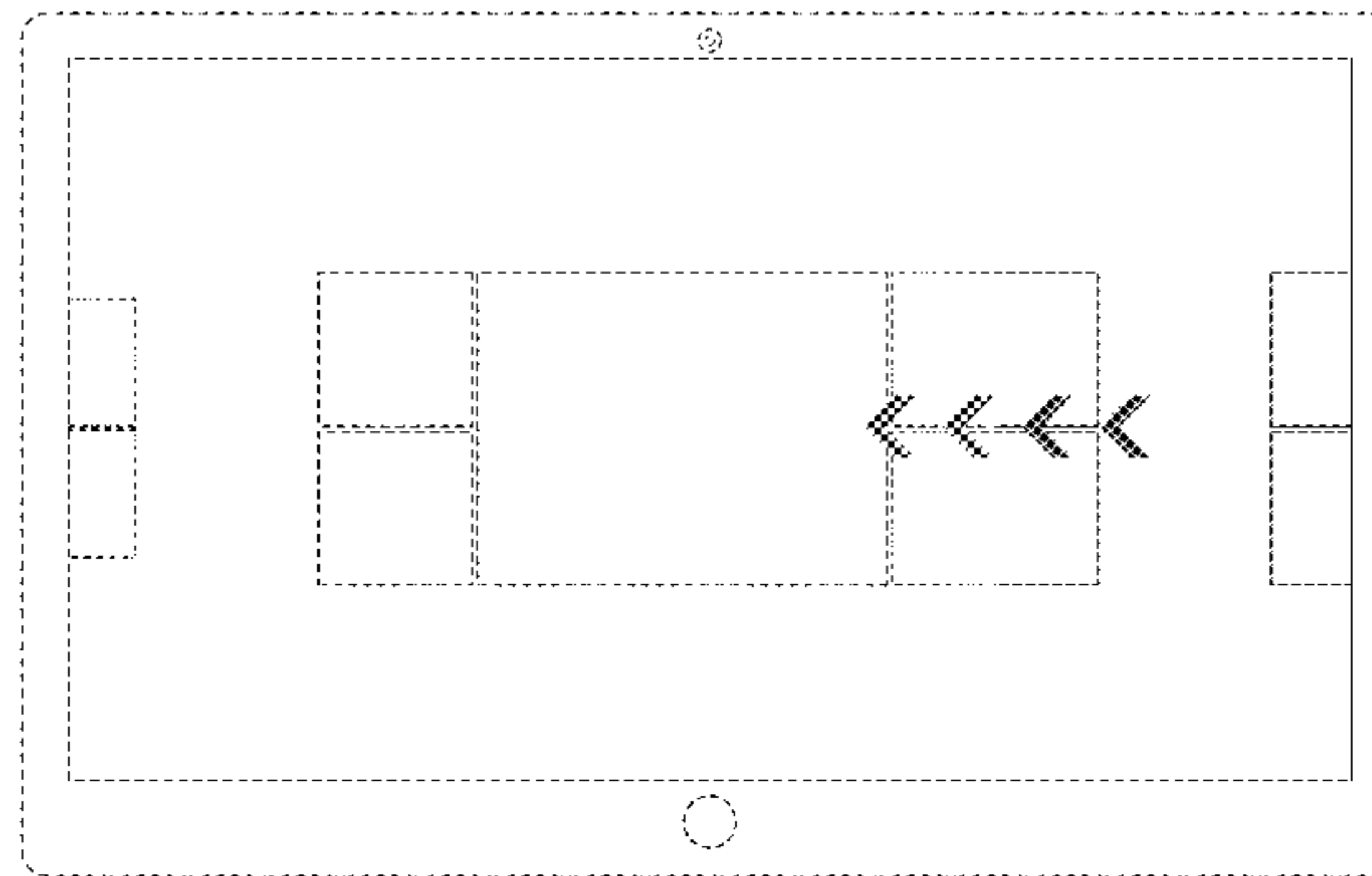
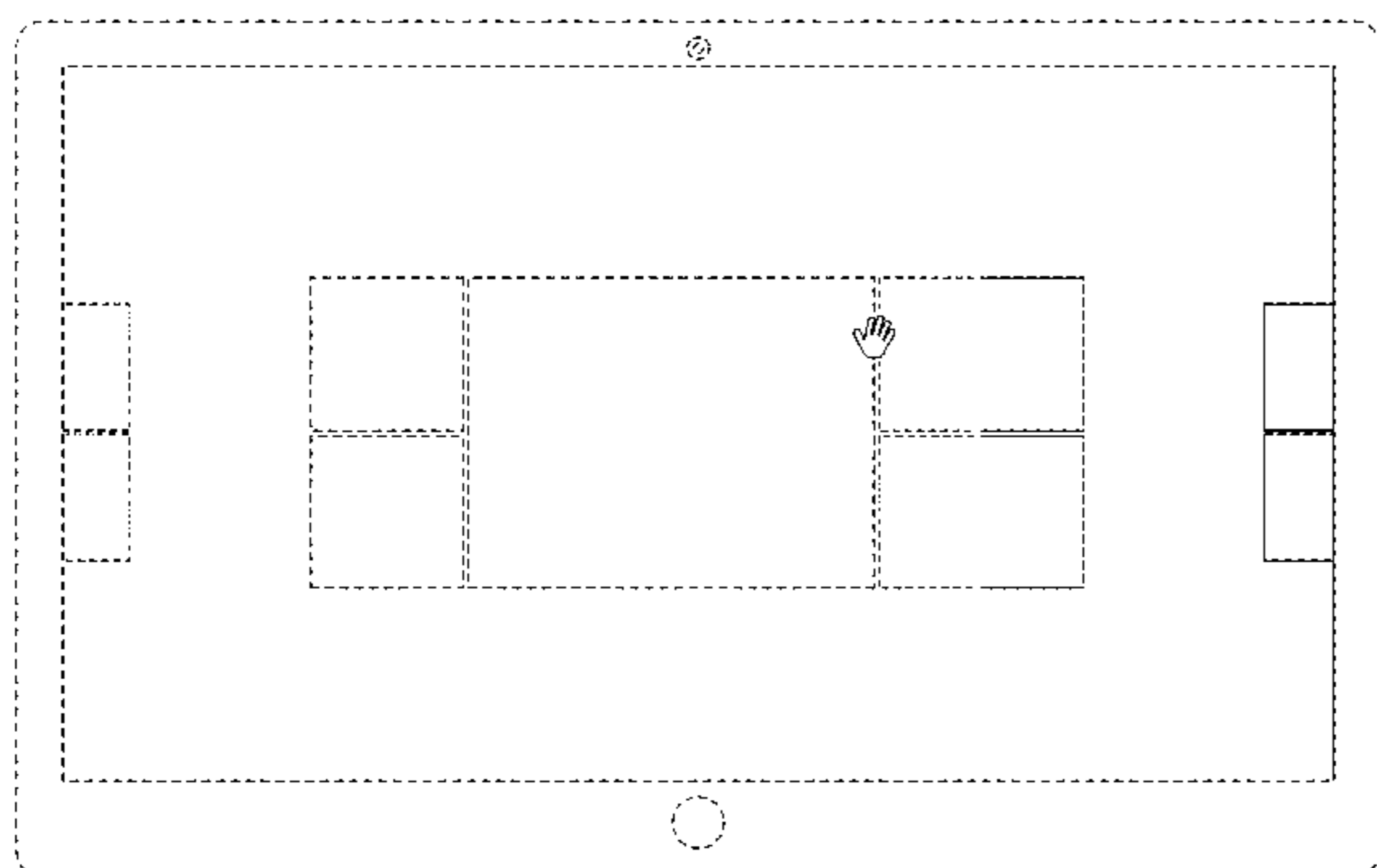

# US D688,680 S

Page 2

---

(56)

## References Cited

### U.S. PATENT DOCUMENTS

D627,363 S 11/2010 Lew  
D629,417 S 12/2010 Weir et al.  
D641,372 S \* 7/2011 Gardner et al. .... D14/486  
D641,373 S \* 7/2011 Gardner et al. .... D14/486

D643,438 S \* 8/2011 Gardner et al. .... D14/486  
D644,661 S \* 9/2011 Gardner et al. .... D14/495  
D644,662 S \* 9/2011 Gardner et al. .... D14/495  
D644,663 S \* 9/2011 Gardner et al. .... D14/495  
D645,469 S 9/2011 Gardner et al.

\* cited by examiner

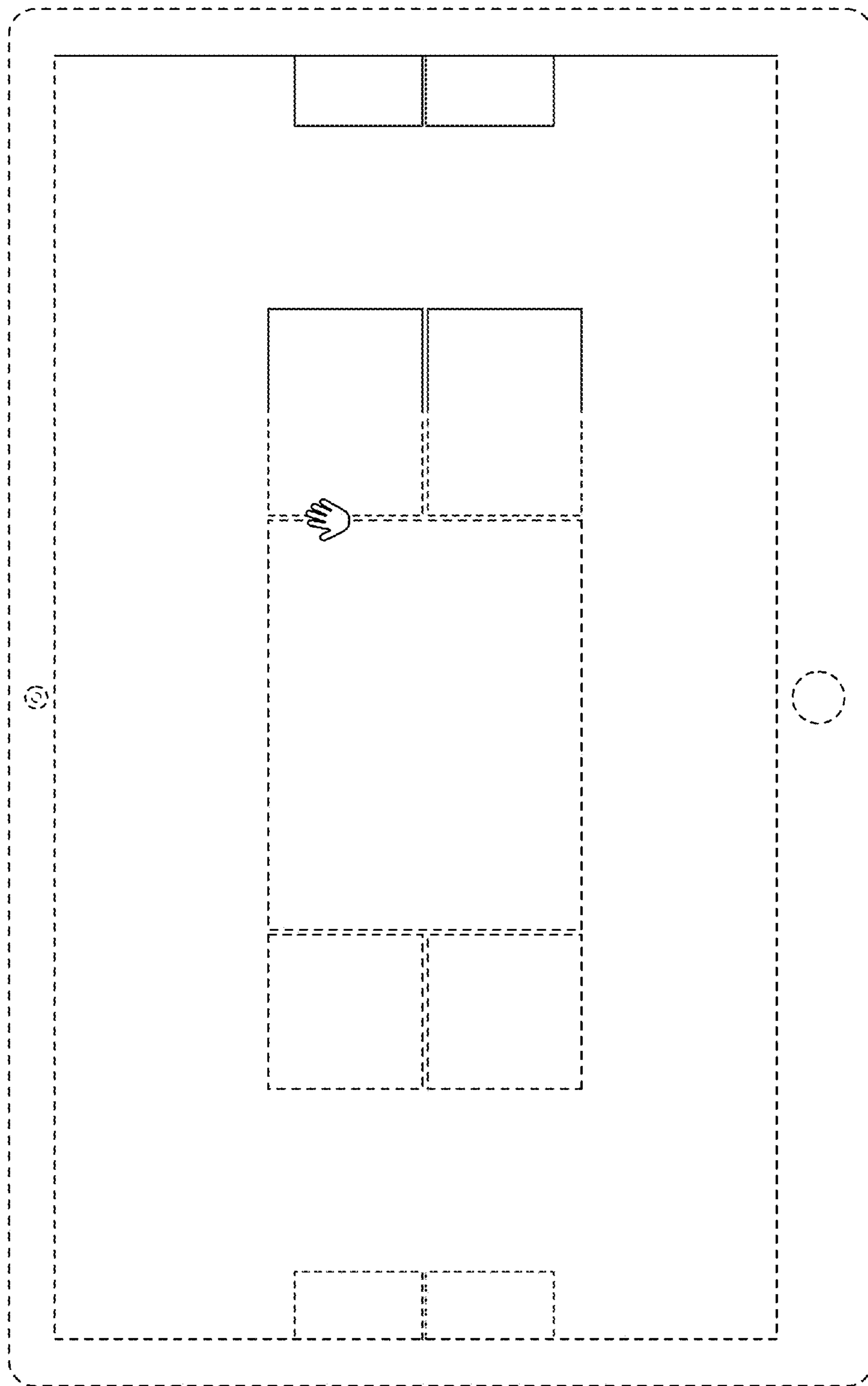

FIG. 1

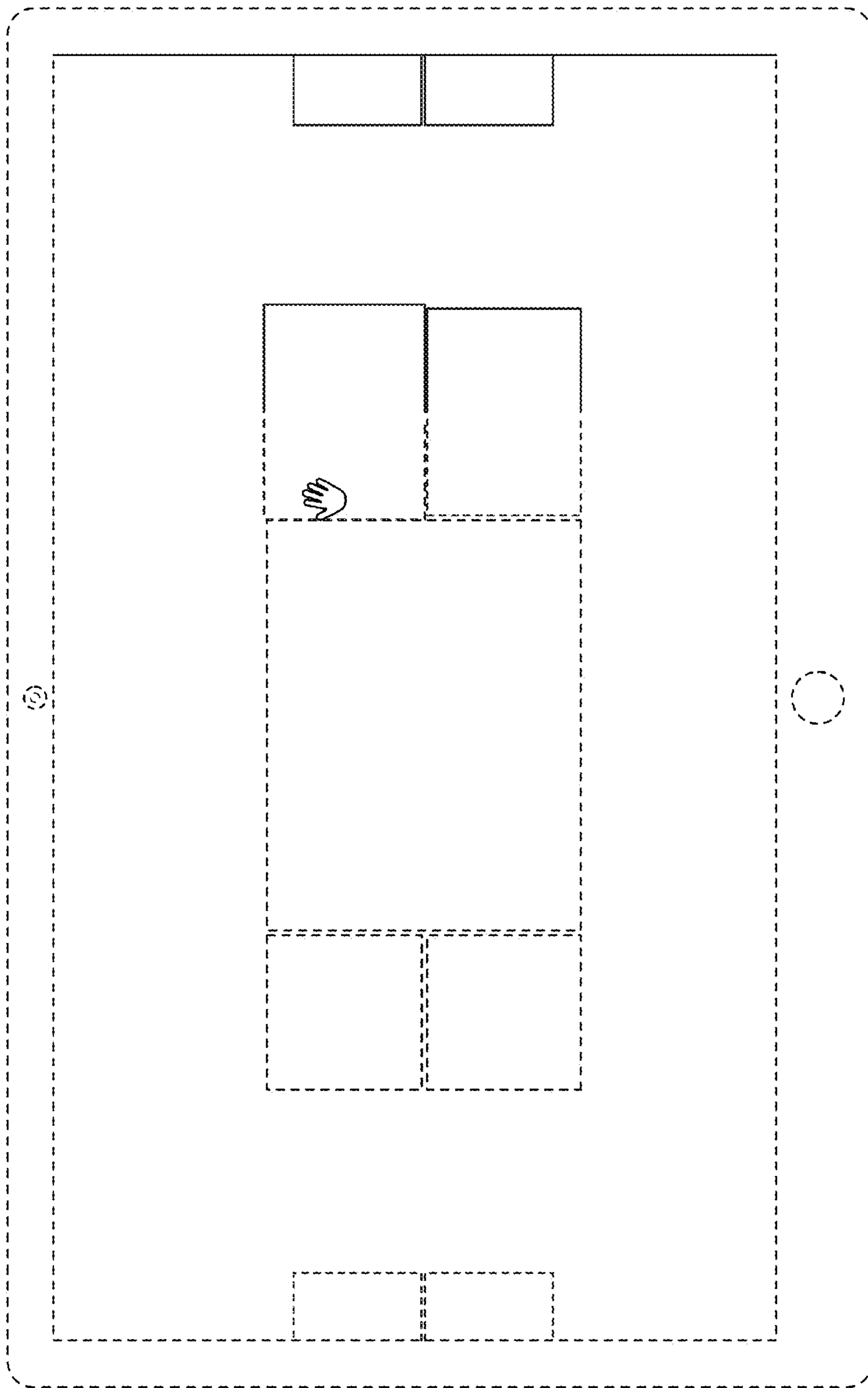

FIG. 2

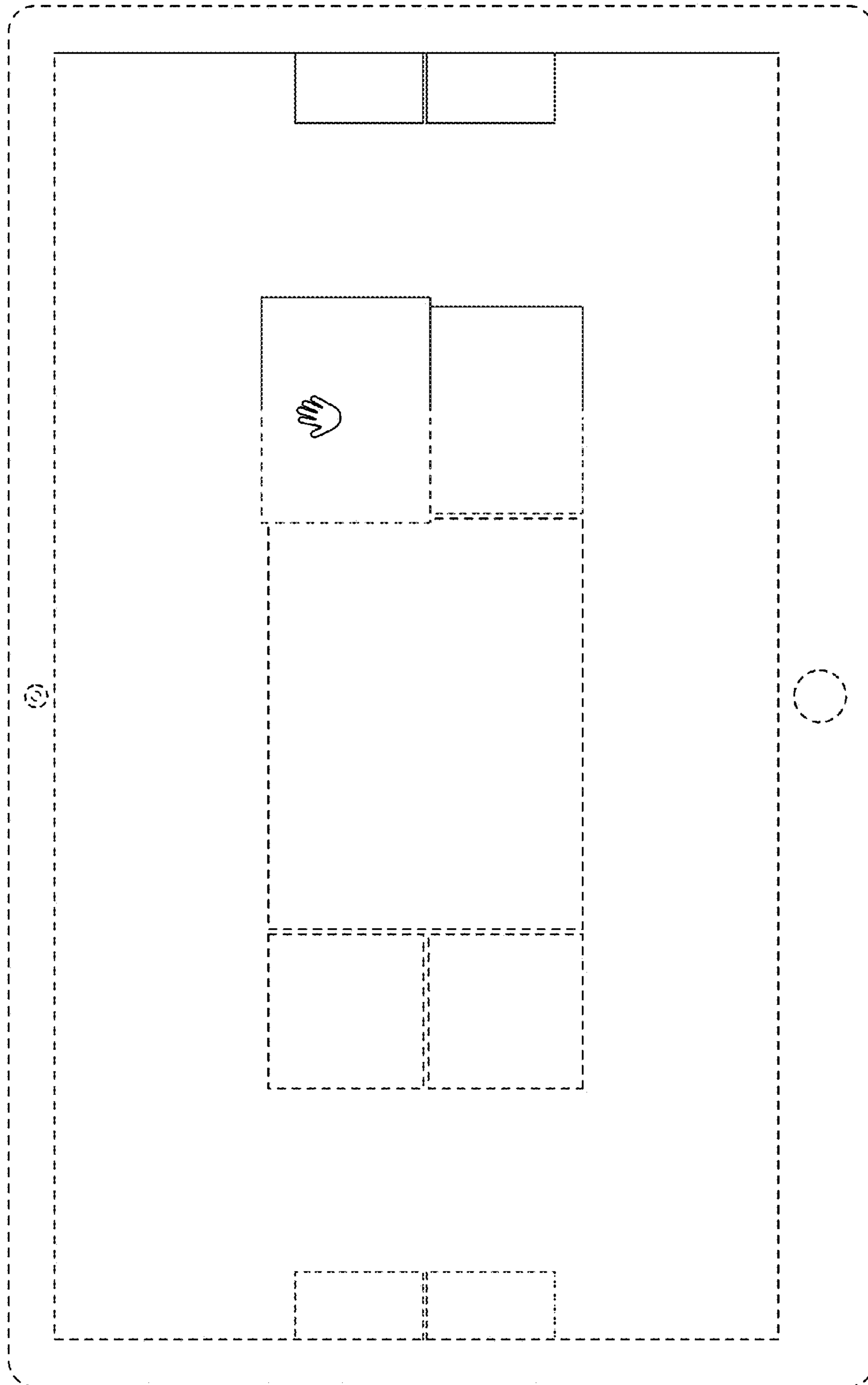

FIG. 3

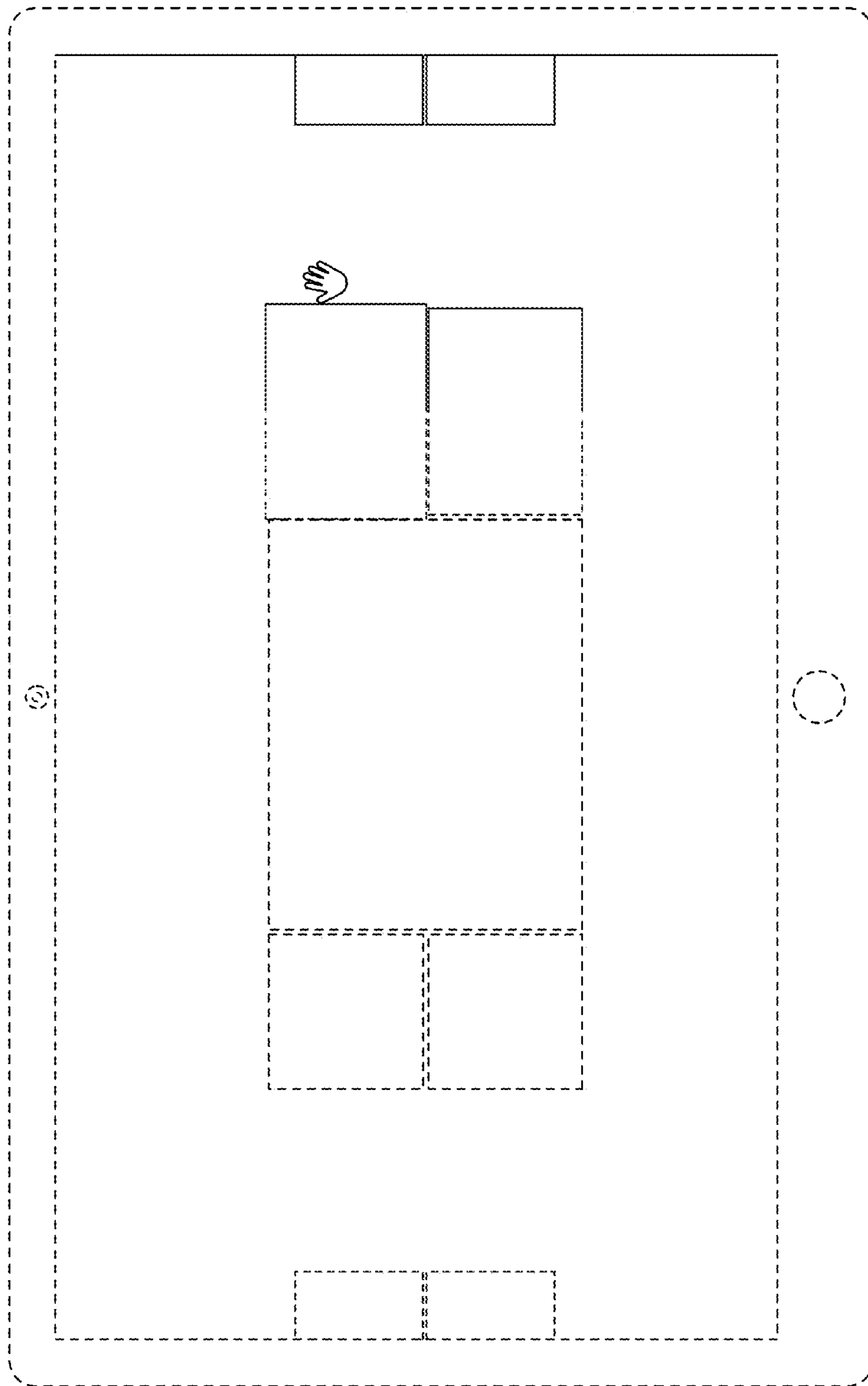

FIG. 4

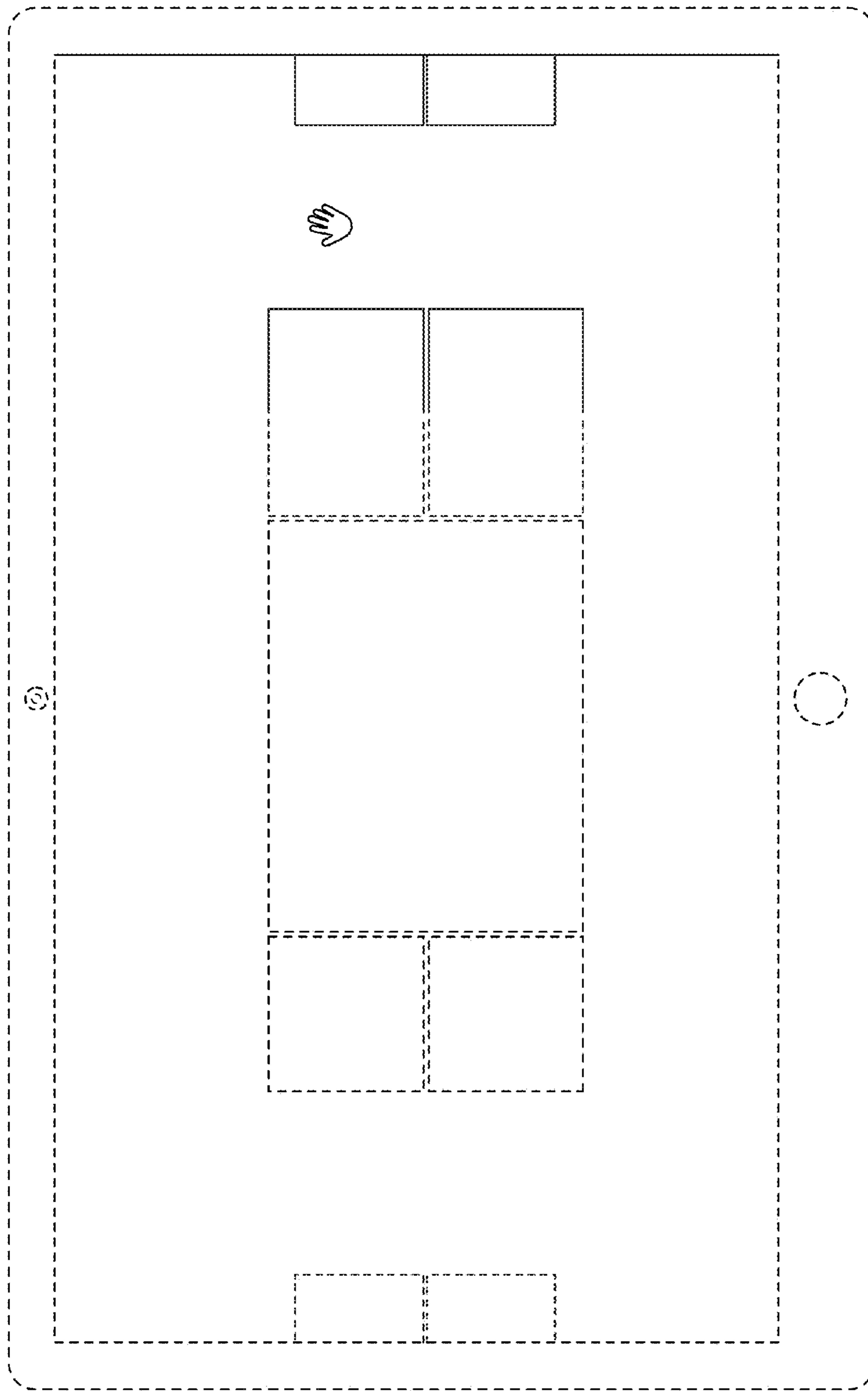

FIG. 5

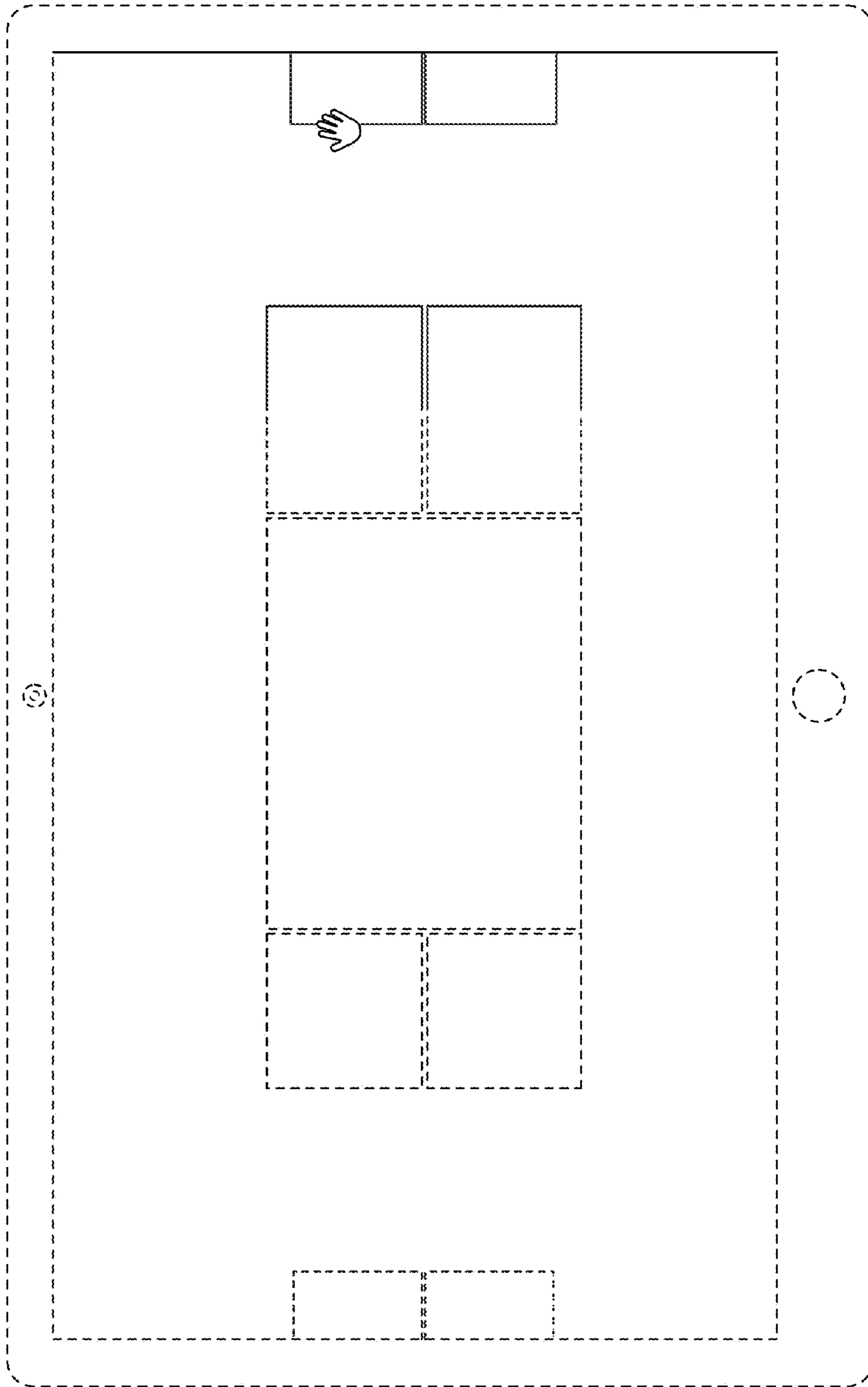

FIG. 6



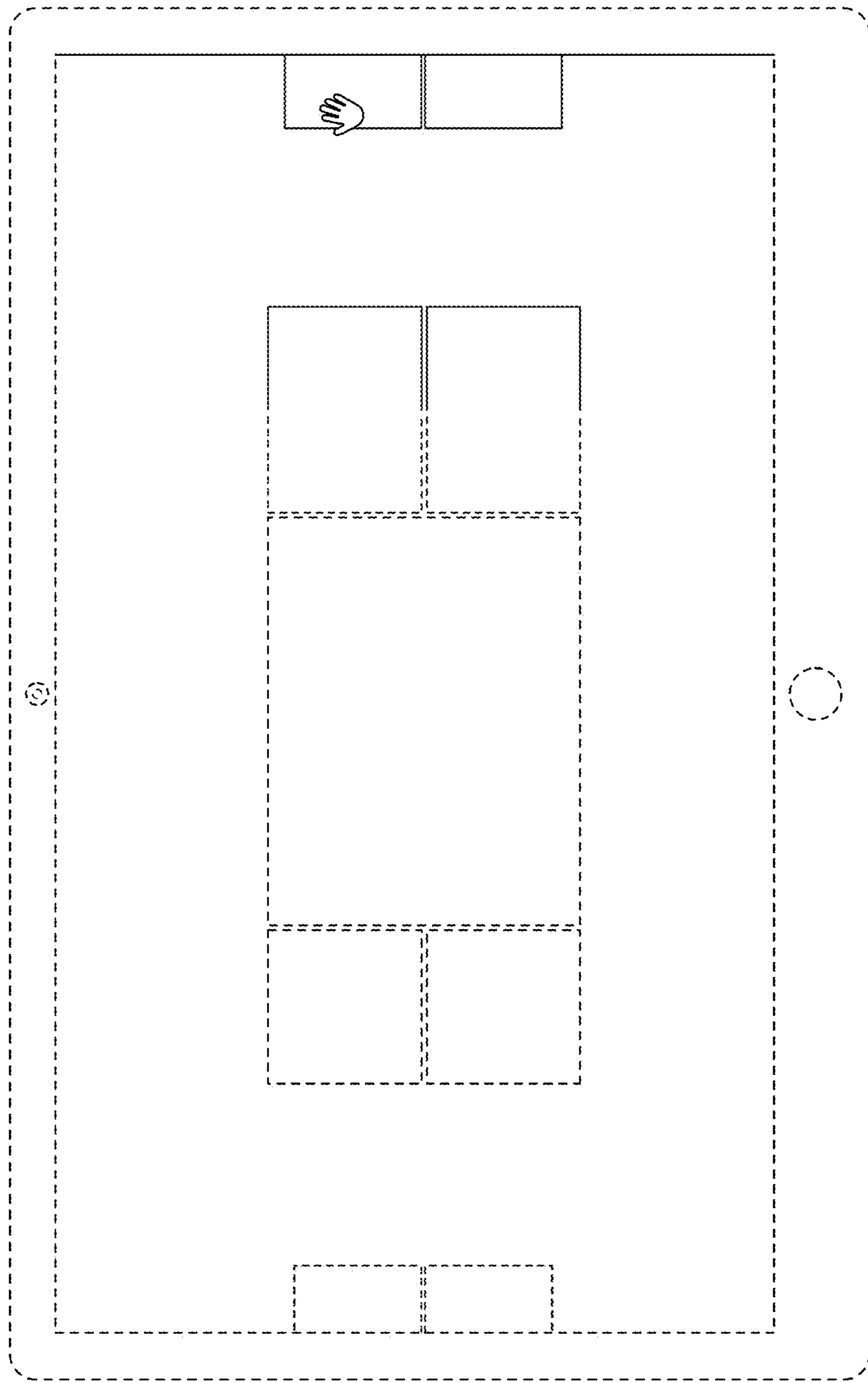

FIG. 7

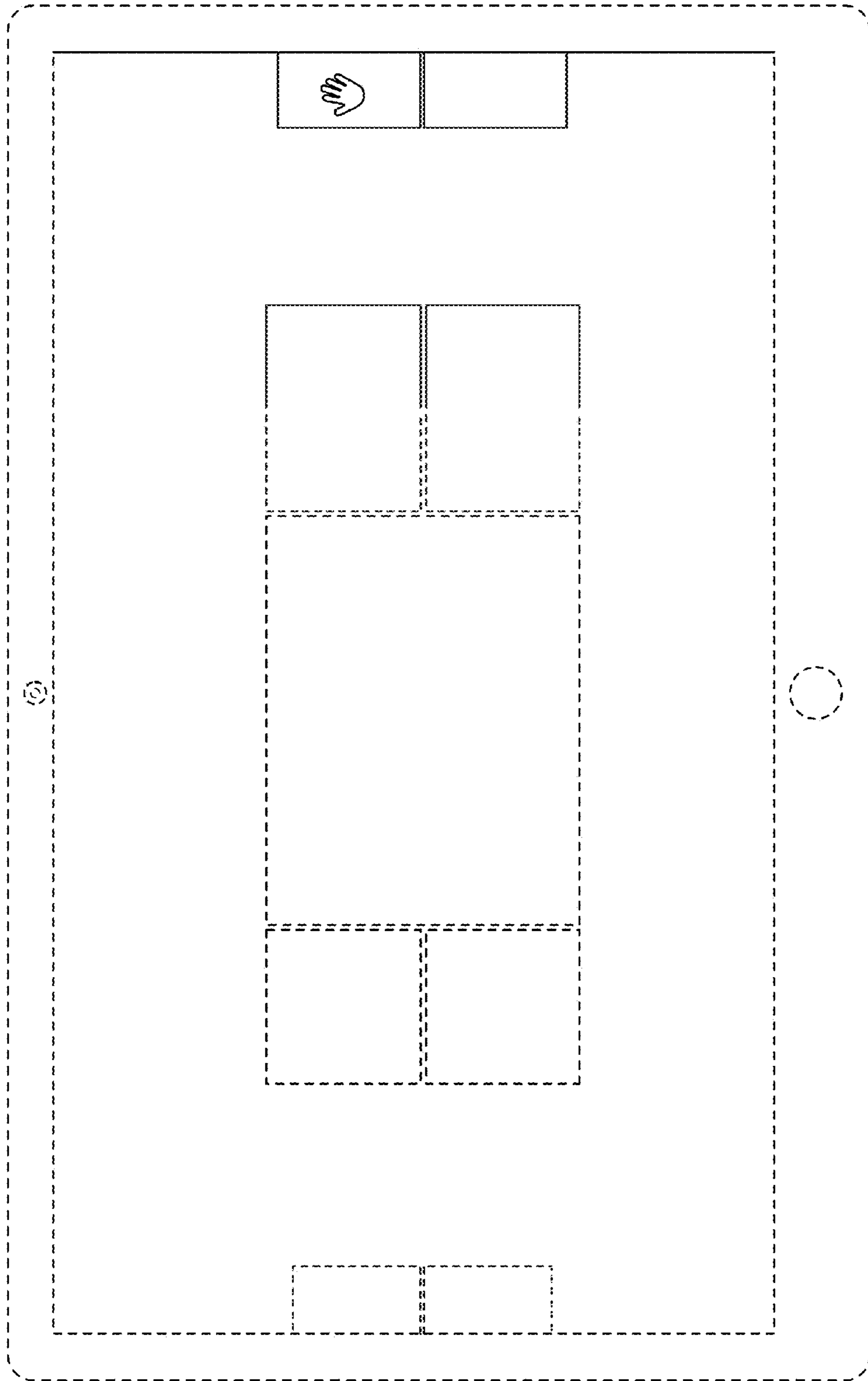

FIG. 8

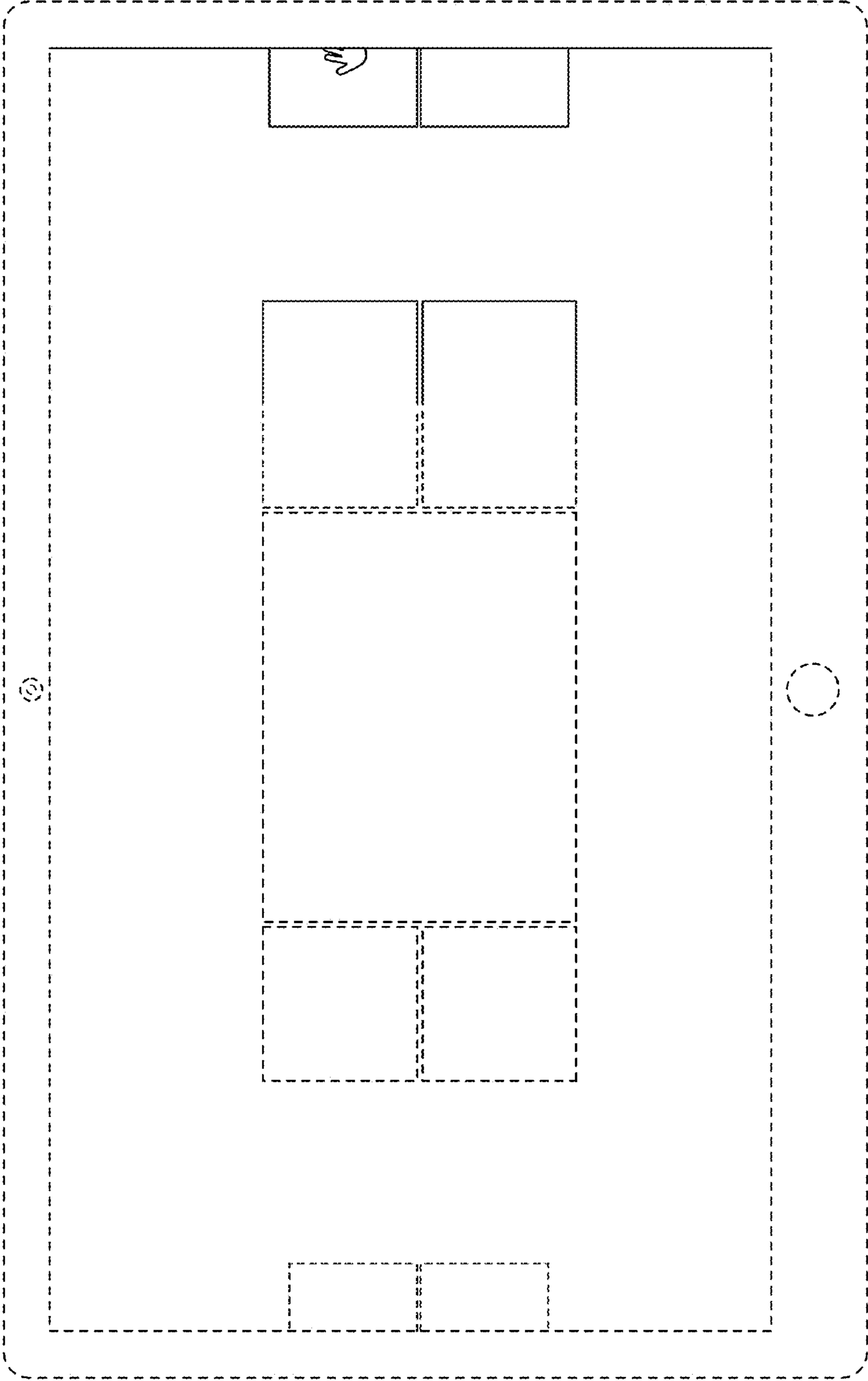

FIG. 9

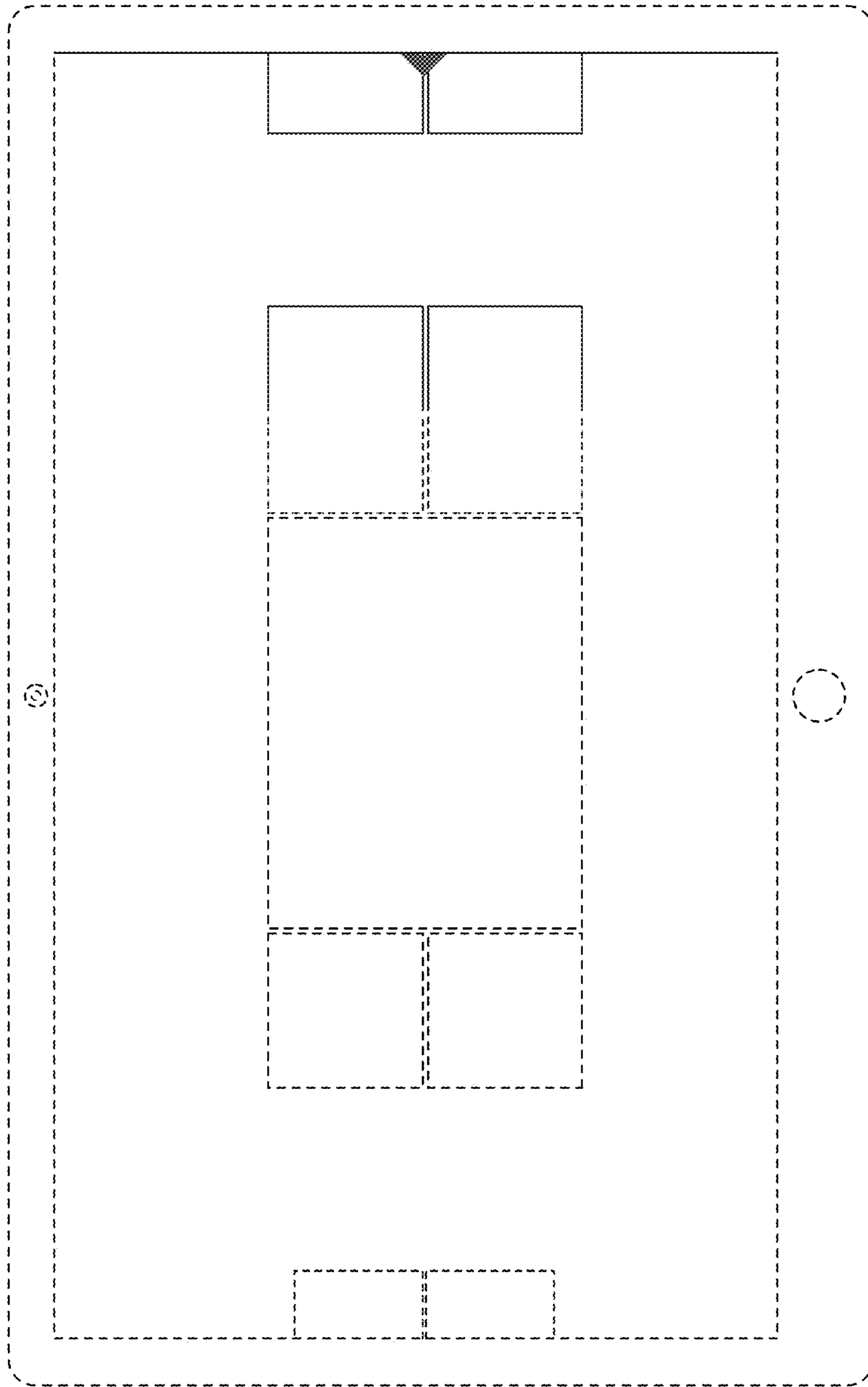
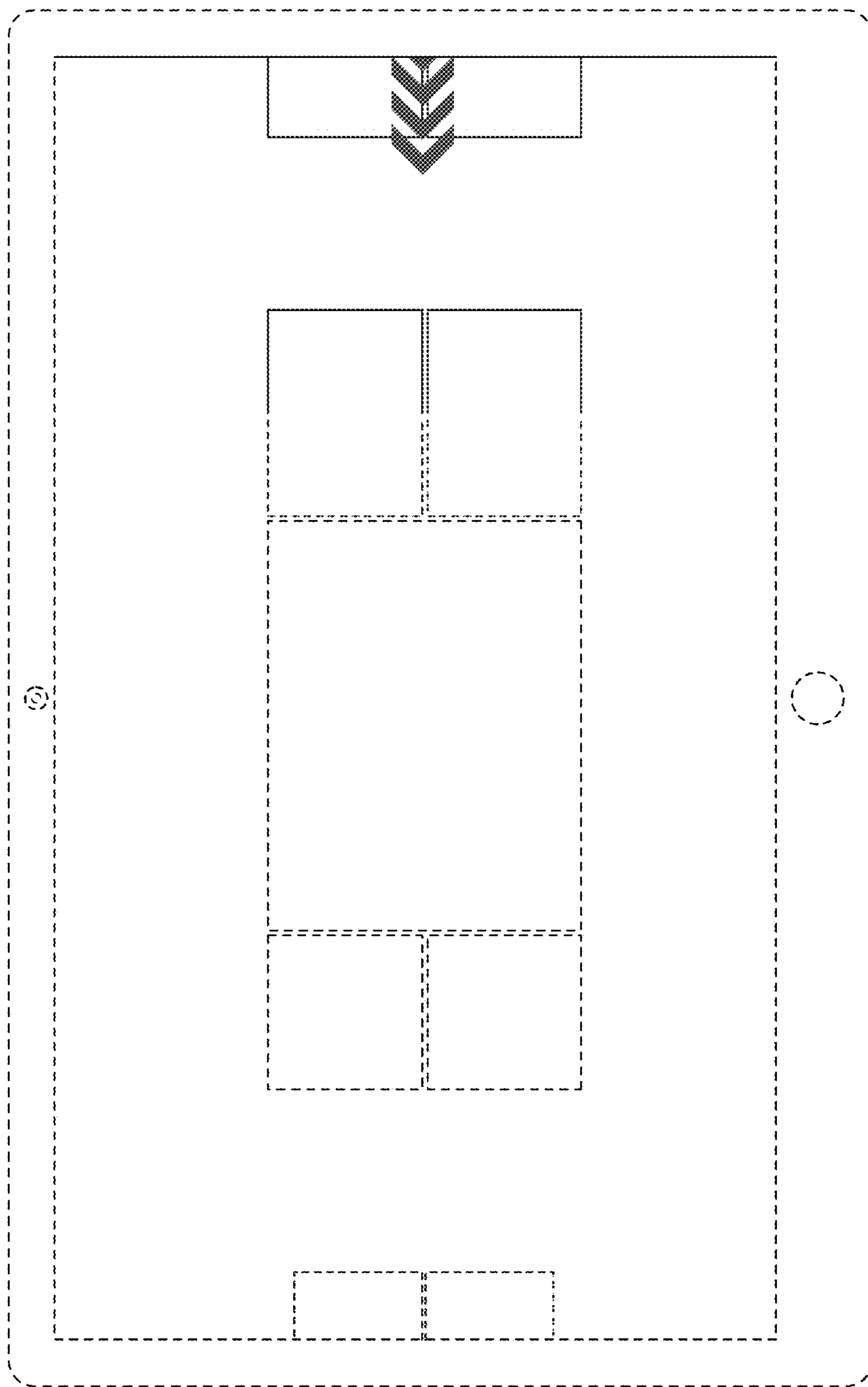

FIG. 10



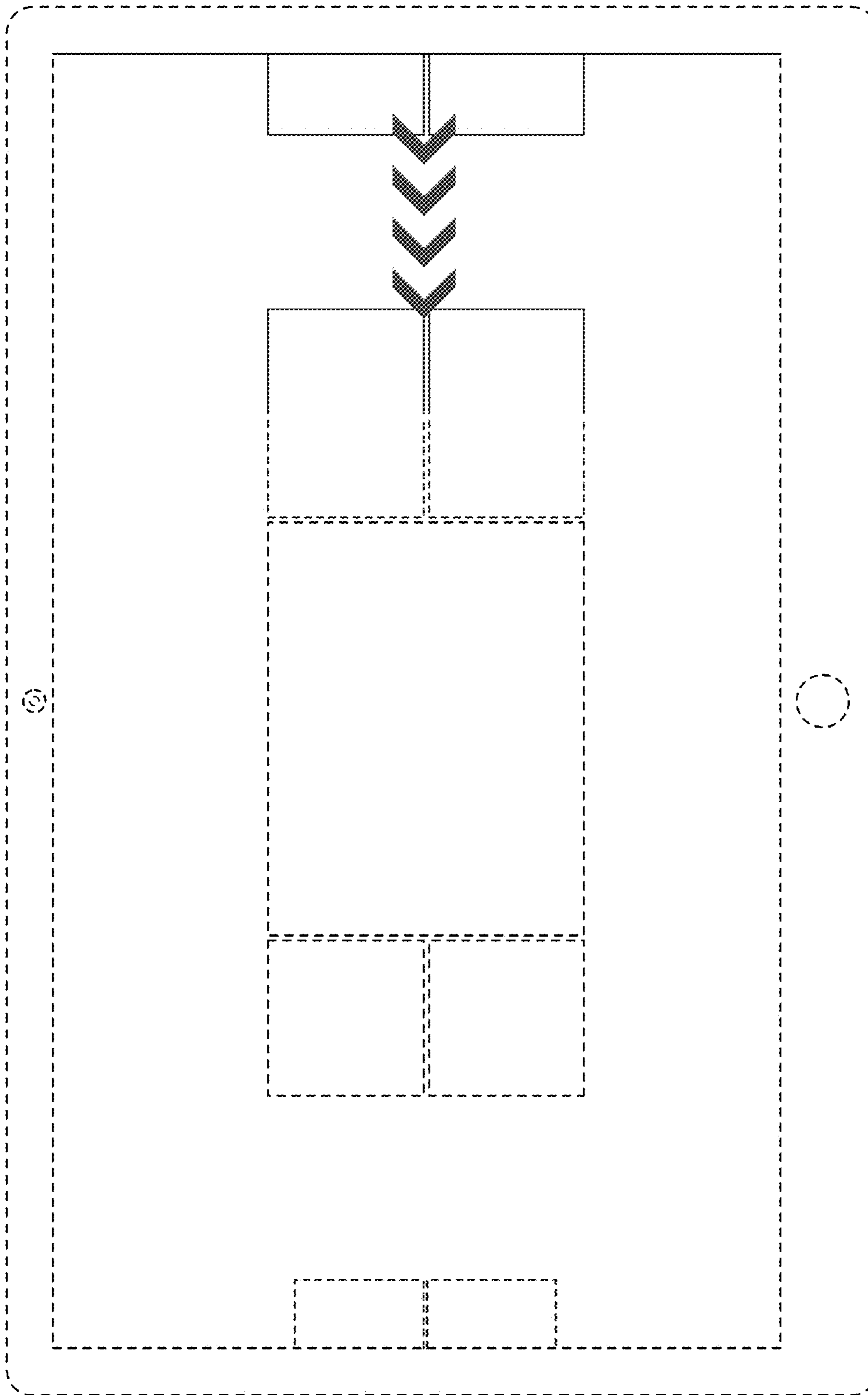

FIG. 12

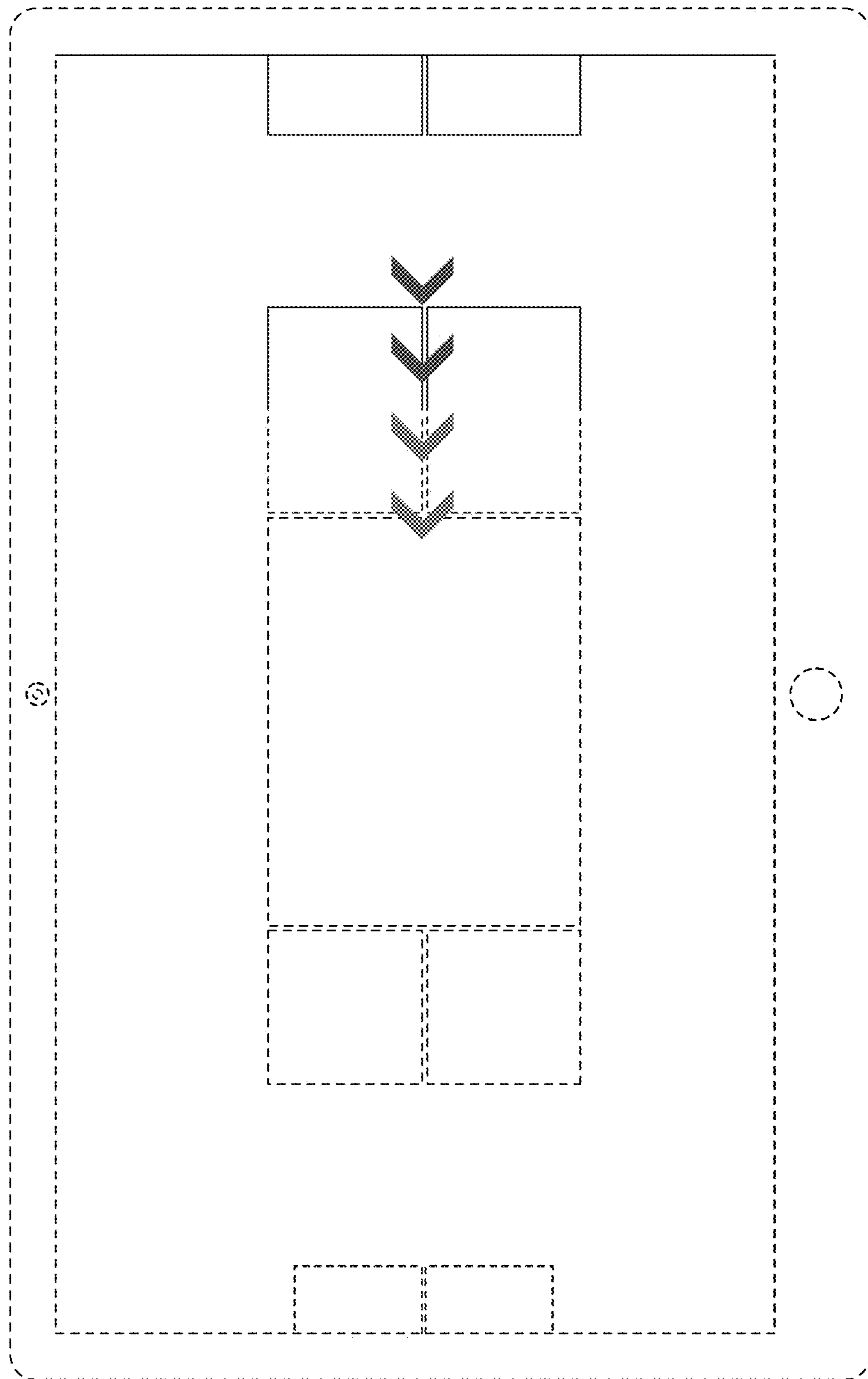
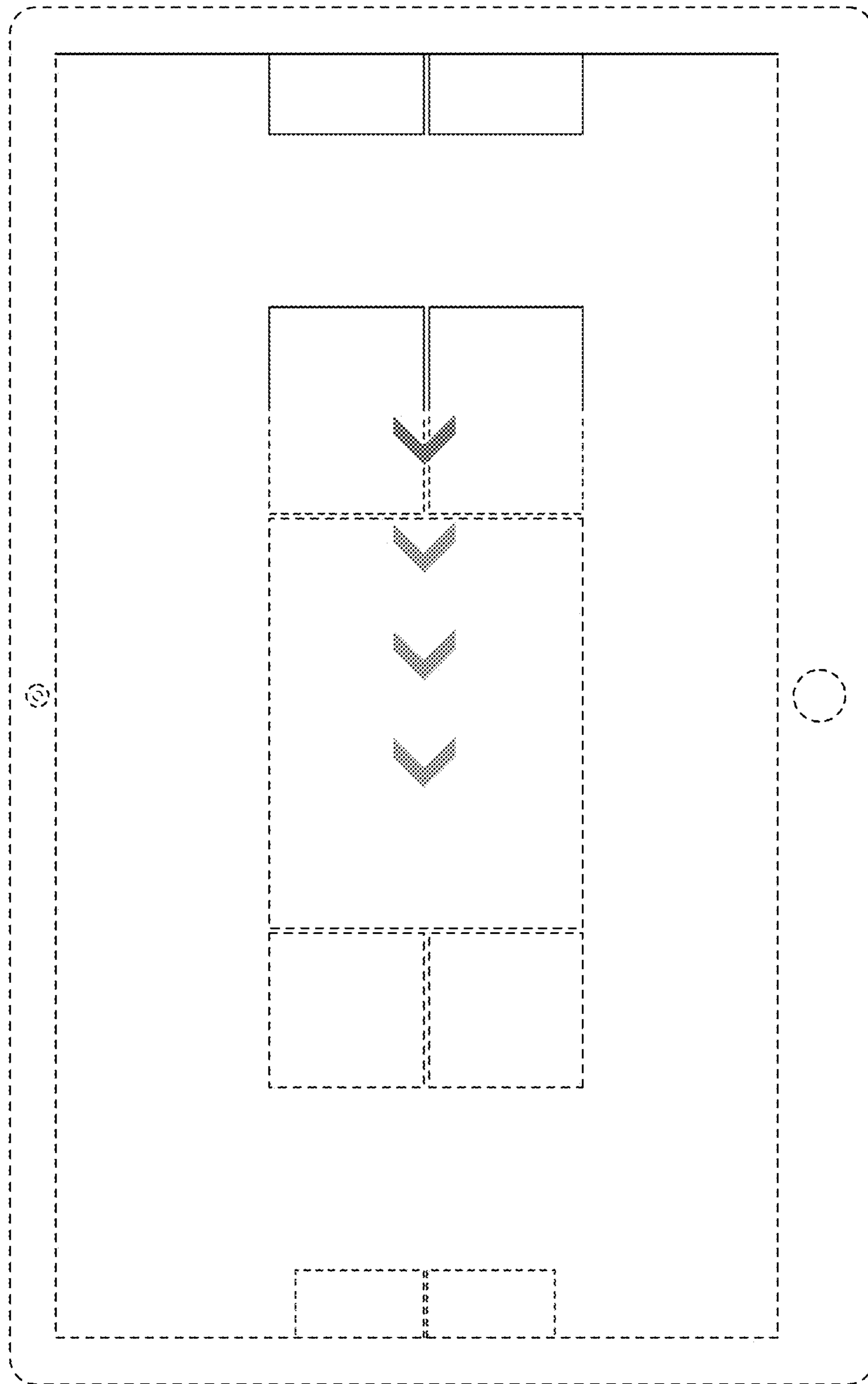

FIG. 13





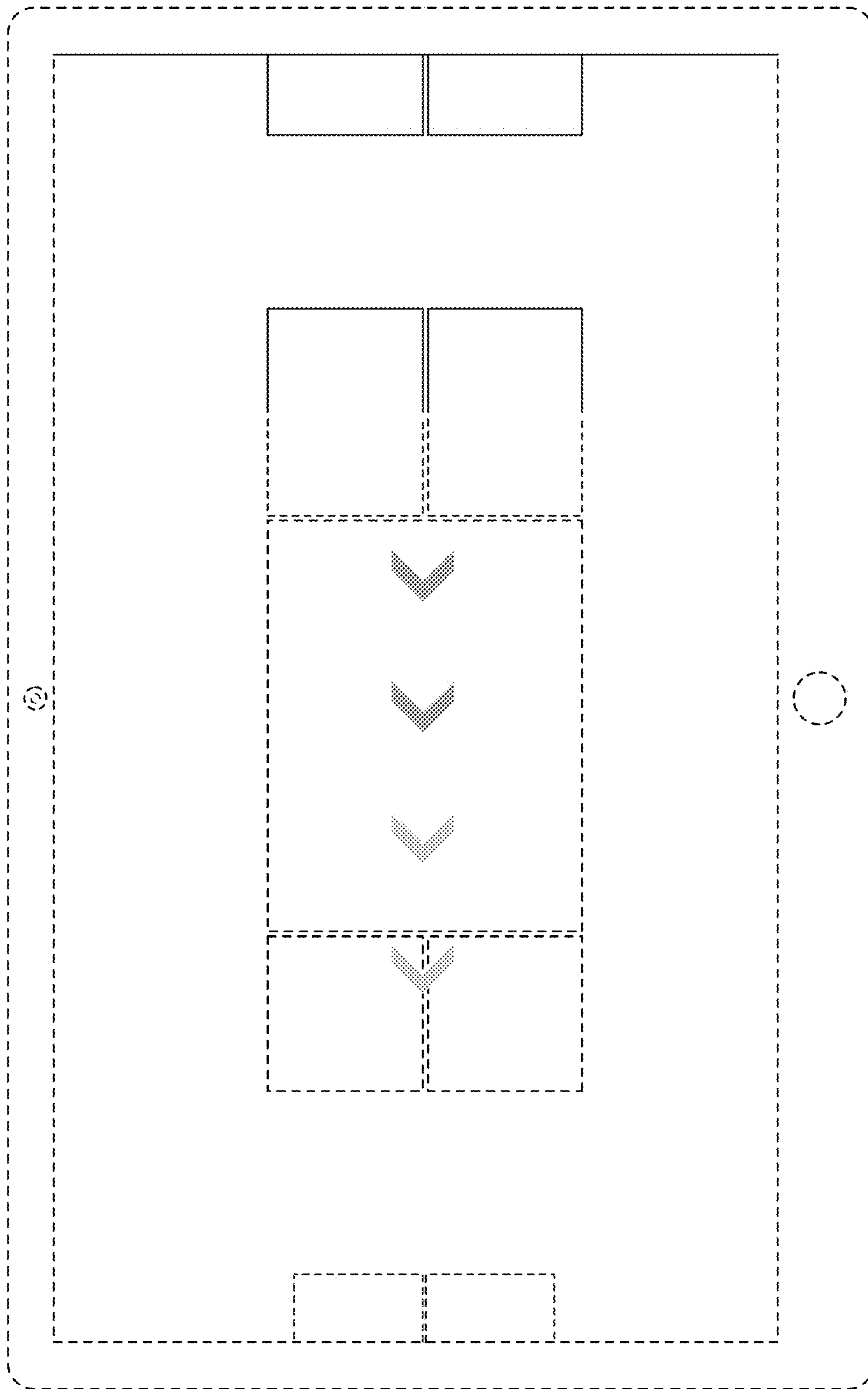

FIG. 15

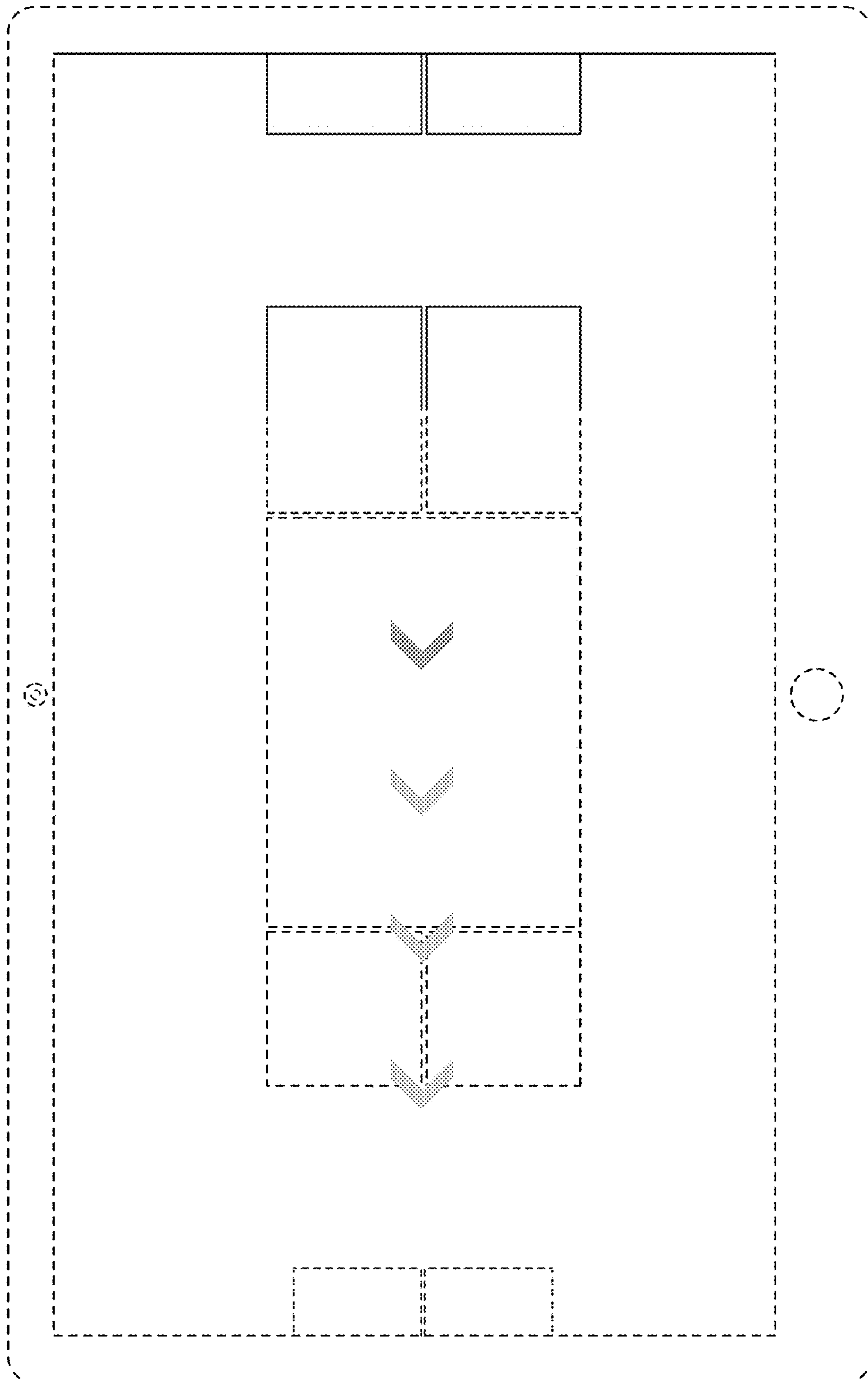

FIG. 16

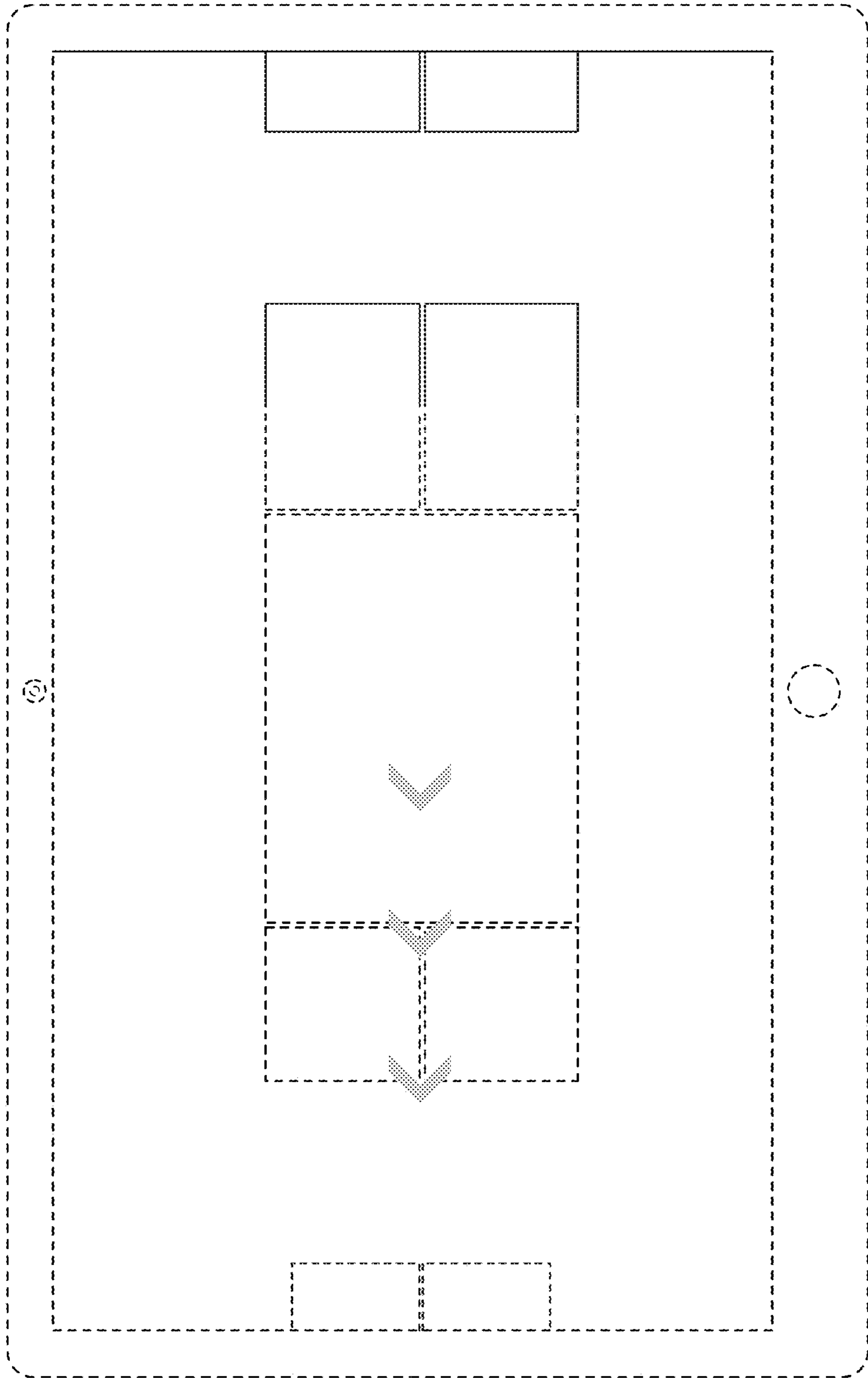

FIG. 17

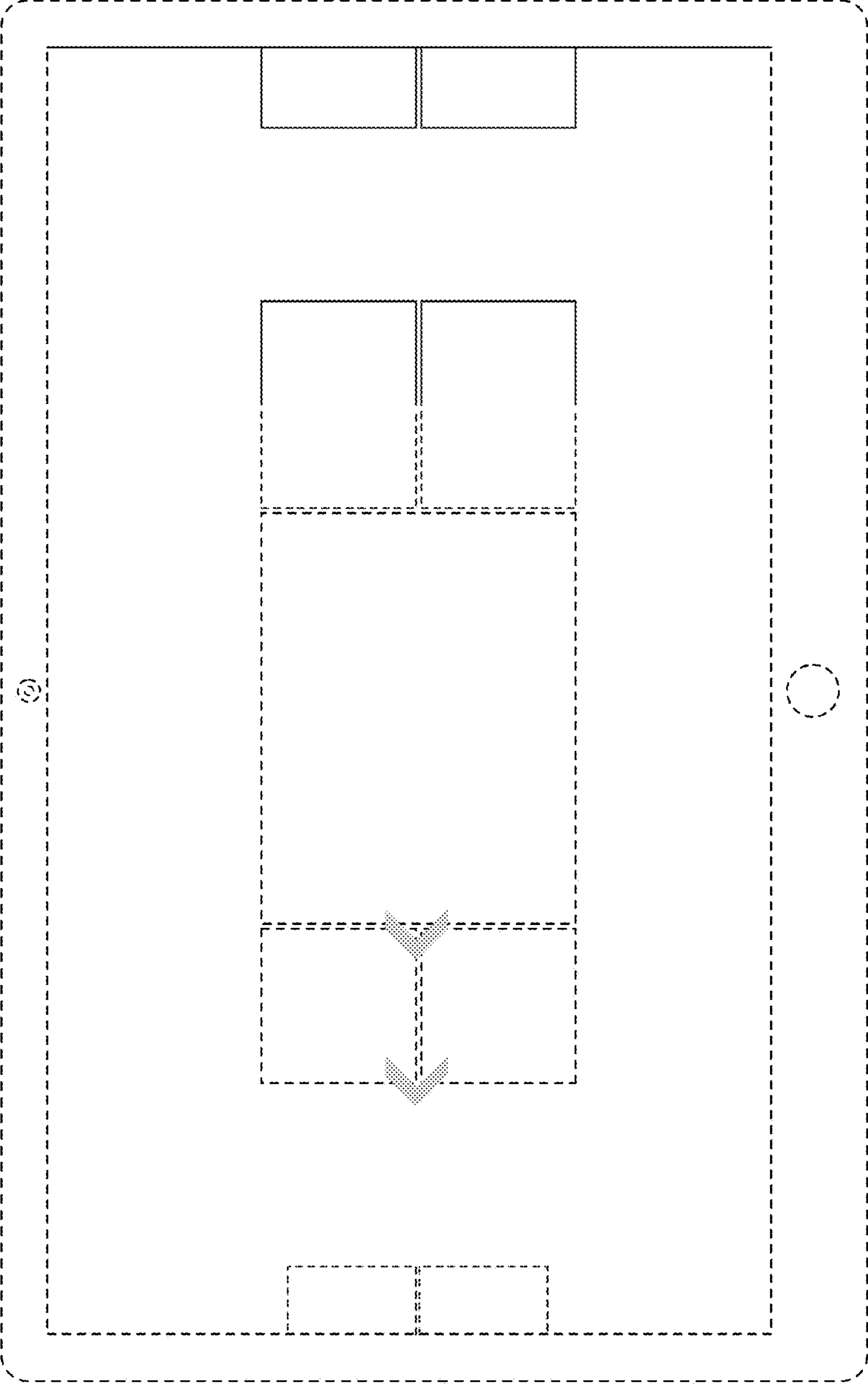

FIG. 18

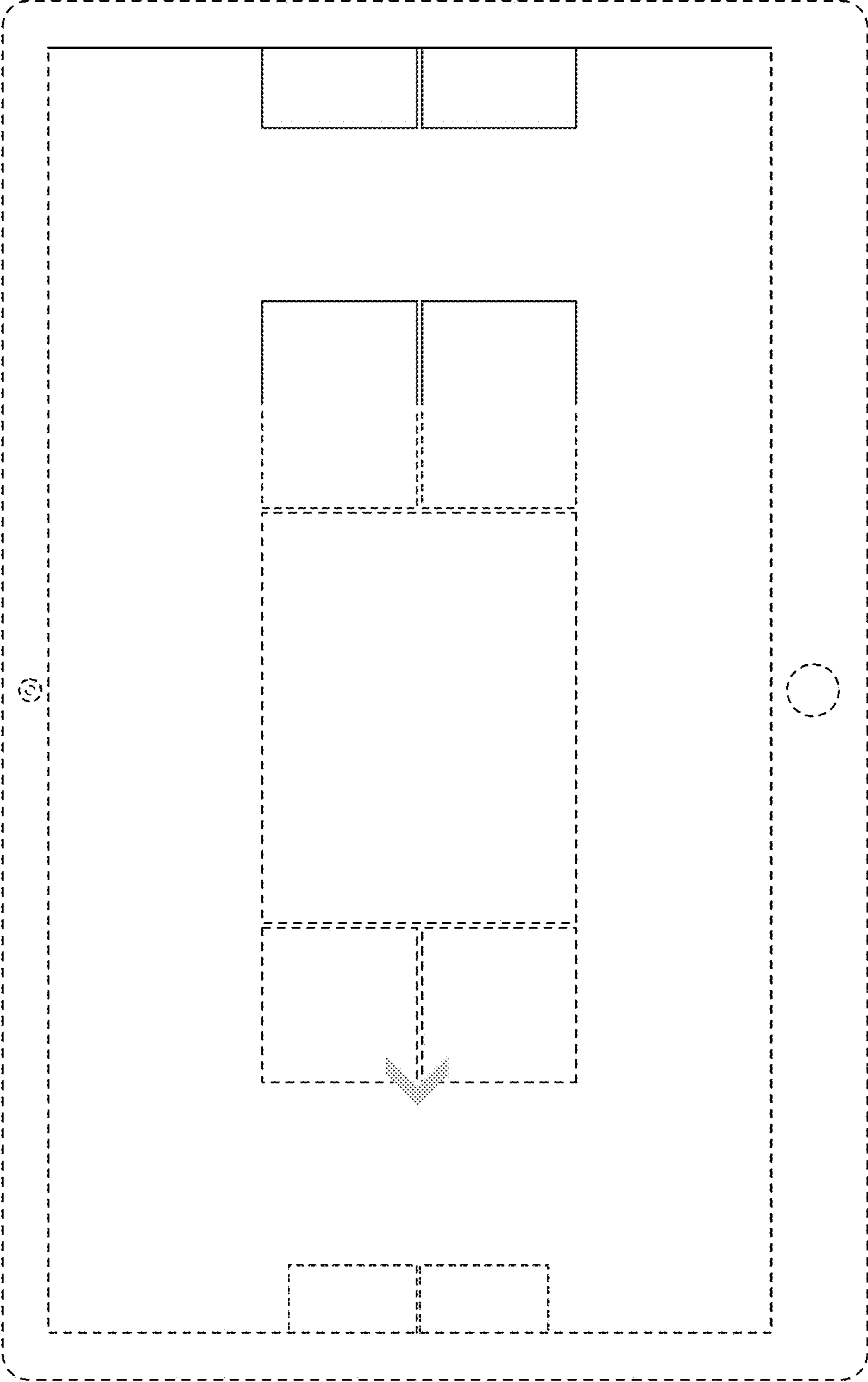

FIG. 19

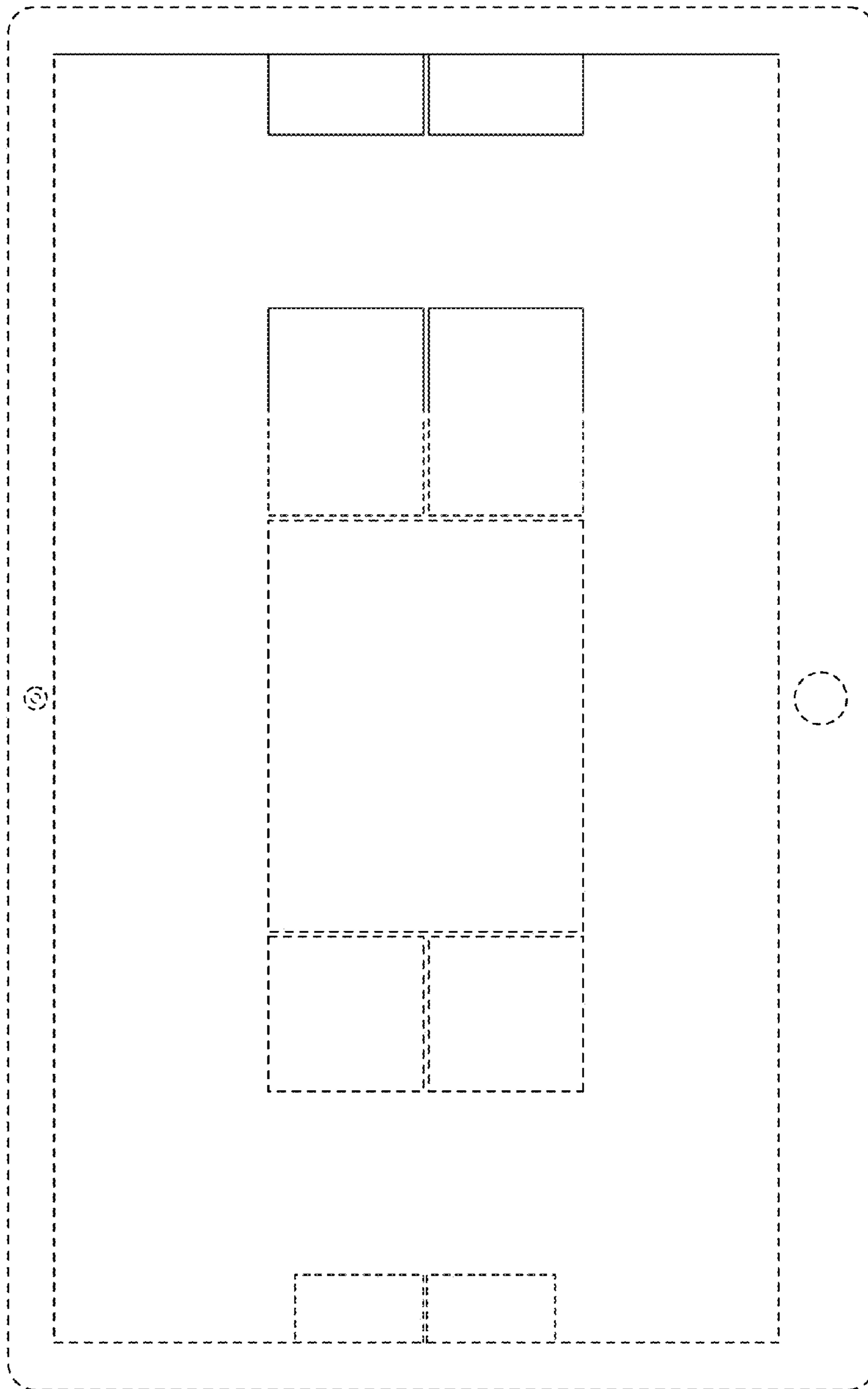

FIG. 20