



US00D688596S

(12) **United States Design Patent**  
**Dunn**

(10) **Patent No.:** **US D688,596 S**

(45) **Date of Patent:** **\*\* \*Aug. 27, 2013**

(54) **SQUARE DISPLAY HOLDER FOR A CORD**

2,601,088 A 6/1952 Burgess  
D167,185 S 7/1952 Wendt  
2,611,615 A 9/1952 Watson

(76) Inventor: **Scott Eben Dunn**, Atlanta, GA (US)

(Continued)

(\* ) Notice: This patent is subject to a terminal disclaimer.

**FOREIGN PATENT DOCUMENTS**

WO WO-2010132567 A1 11/2010

(\*\*) Term: **14 Years**

**OTHER PUBLICATIONS**

(21) Appl. No.: **29/411,315**

Specification, Claims, and Drawings entered by the U.S. Patent and Trademark Office on Feb. 4, 2011 for U.S. Appl. No. 61/439,606, filed Feb. 4, 2011 (First Named Inventor—Dunn) (21 pages).

(22) Filed: **Jan. 19, 2012**

(Continued)

(51) **LOC (9) Cl.** ..... **11-02**

(52) **U.S. Cl.**  
USPC ..... **D11/184**

(58) **Field of Classification Search**  
USPC ..... 3/184; D8/105, 107, 333, 349, 354,  
D8/356, 358, 367, 373, 382, 383, 394–396;  
D23/261; D26/38; 24/197; 174/153 G;  
242/400.1, 405.1, 405.2, 600, 916; 248/65,  
248/74.1–74.4, 214, 215, 229.26, 201, 302,  
248/204, 31, 6.7, 316.8; 439/501; D34/38;  
108/57.52; D24/128

*Primary Examiner* — T. Chase Nelson  
*Assistant Examiner* — Michelle E Wilson  
(74) *Attorney, Agent, or Firm* — Ballard Spahr LLP

(57) **CLAIM**  
The ornamental design for a square display holder for a cord, as shown and described.

See application file for complete search history.

**DESCRIPTION**

FIG. 1 is a perspective view of an embodiment of a square display holder for a cord of the present invention; FIG. 2 is a front elevational view of the square display holder for a cord of FIG. 1; FIG. 3 is a rear elevational view of the square display holder for a cord of FIG. 1; FIG. 4 is a left side elevational view of the square display holder for a cord of FIG. 1; FIG. 5 is a right side elevational view of the square display holder for a cord of FIG. 1; FIG. 6 is a top plan view of the square display holder for a cord of FIG. 1; FIG. 7 is a bottom plan view of the square display holder for a cord of FIG. 1; and, FIG. 8 is a rear perspective view of the square display holder for a cord of FIG. 1.

(56) **References Cited**

**U.S. PATENT DOCUMENTS**

168,063 A 9/1875 Taylor  
807,747 A 12/1905 Kling  
1,195,276 A 8/1916 Seaman  
1,337,722 A 4/1920 Porter  
1,388,219 A 8/1921 Thompson  
D67,289 S 5/1925 Ladewich  
1,593,078 A 7/1926 Jacoss  
2,083,431 A 6/1937 Cole  
D133,983 S 10/1942 Anderson  
D137,768 S 4/1944 Shirley  
2,355,154 A 8/1944 Goudreau  
D156,622 S 12/1949 Harmon  
1,832,318 A 11/1951 Myers

**1 Claim, 6 Drawing Sheets**

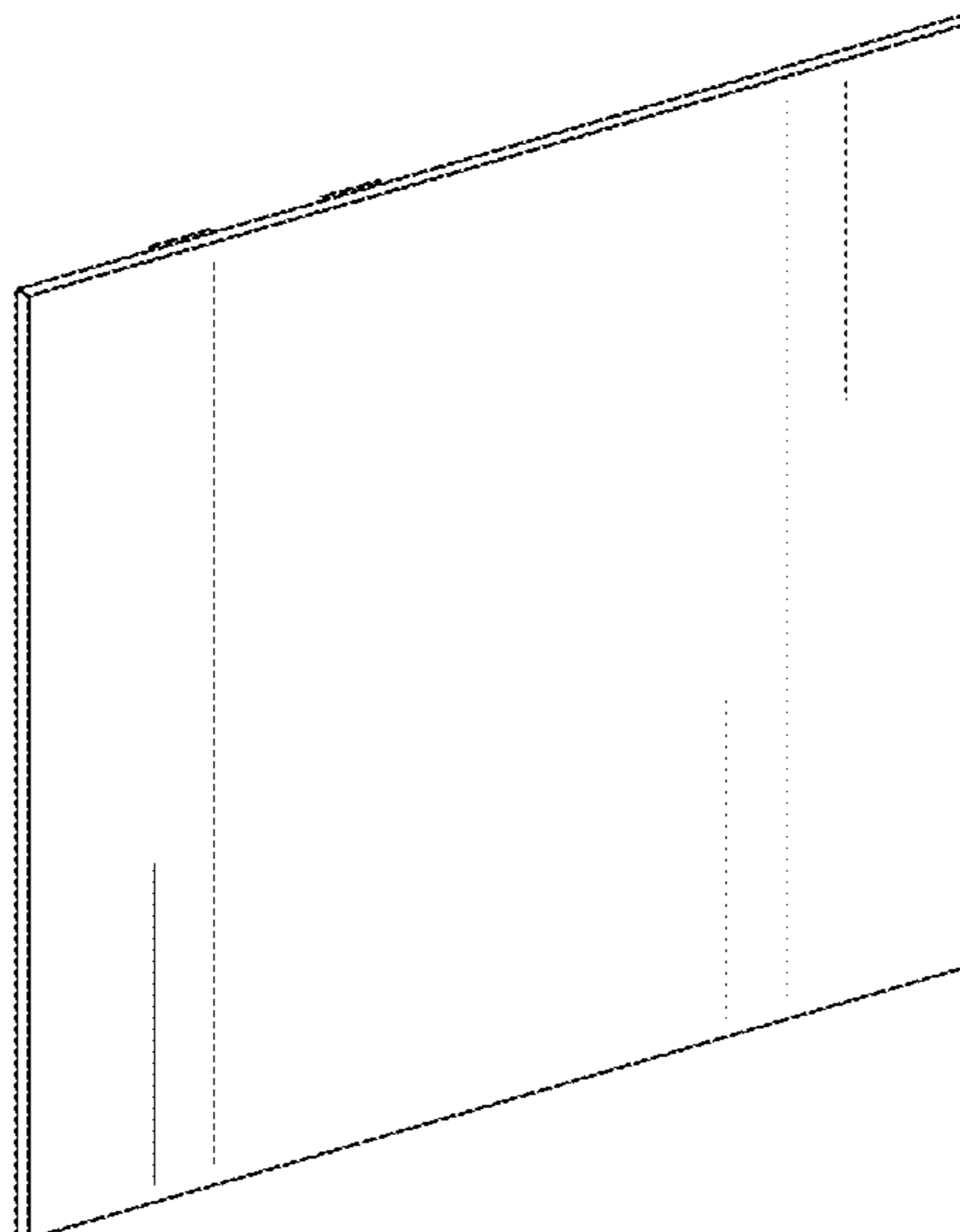

(56)

References Cited

U.S. PATENT DOCUMENTS

2,616,196 A	11/1952	Sandahl		5,869,784 A	2/1999	Shinchi	
D170,594 S *	10/1953	Leonard et. al	D24/128	D407,453 S	3/1999	Rashman	
2,786,983 A	3/1957	Hill		5,887,368 A	3/1999	Rupp	
3,203,700 A	8/1965	Kheainne		D412,136 S	7/1999	Namdar et al.	
3,228,640 A	1/1966	Wolsh		5,922,993 A	7/1999	Ide et al.	
3,322,381 A	5/1967	Bubb		5,925,202 A	7/1999	Ide et al.	
3,519,731 A	7/1970	Grunbaum		5,929,384 A	7/1999	Ide et al.	
3,576,304 A *	4/1971	Gillemot et al.	248/74.2	5,933,995 A	8/1999	Gorbach	
3,696,920 A *	10/1972	Lahay	206/370	5,934,509 A	8/1999	Niss	
3,766,854 A	10/1973	Scarlet		D413,544 S	9/1999	Steinberg	
3,772,809 A	11/1973	Schneller		5,971,436 A	10/1999	Cox	
3,788,269 A	1/1974	Scarlet		5,979,028 A	11/1999	Hicks et al.	
D235,023 S	4/1975	Swayze		D421,773 S	3/2000	Yashar	
4,004,362 A	1/1977	Barbieri		6,087,589 A	7/2000	Ide	
4,011,673 A	3/1977	Levine		6,120,565 A	9/2000	Dix et al.	
4,103,949 A	8/1978	Bouloy		D436,518 S *	1/2001	Matsubara	D8/356
4,131,226 A	12/1978	Breiter et al.		D438,624 S	3/2001	Reina	
4,177,750 A	12/1979	Scarlet		D438,788 S	3/2001	Rigel	
4,198,202 A	4/1980	Kleber		6,226,865 B1	5/2001	Tanikawa et al.	
D256,398 S	8/1980	Mitchell		D446,676 S	8/2001	Mayes	
4,261,121 A	4/1981	Coon		D446,903 S	8/2001	Pavan	
4,294,895 A	10/1981	Atkins		6,269,573 B1	8/2001	Najmi	
D264,379 S *	5/1982	Slinkard	D24/128	D448,276 S	9/2001	Kelleghan	
D266,054 S	9/1982	Goodman		6,301,756 B1	10/2001	Howard	
4,398,444 A	8/1983	Walker		D449,981 S	11/2001	Davis	
D270,525 S	9/1983	Bayusik		D452,135 S	12/2001	Wyatt et al.	
D275,174 S *	8/1984	Rolli	D8/356	6,332,247 B1	12/2001	Hsieh	
4,464,834 A	8/1984	Simms		D454,244 S *	3/2002	Scheff	D99/34
D280,393 S	9/1985	Lee		D454,971 S	3/2002	Crosby	
D280,394 S	9/1985	Lee		D455,145 S	4/2002	Williams	
4,539,767 A	9/1985	Jaffe		D456,016 S	4/2002	Denson	
D285,044 S *	8/1986	Mockett	D8/354	D456,389 S	4/2002	Denson	
D289,138 S *	4/1987	Nead	D8/356	D456,692 S *	5/2002	Epstein	D8/356
4,656,767 A	4/1987	Tarrant		D457,157 S	5/2002	Best	
D289,732 S *	5/1987	Jason	D8/356	6,381,840 B2	5/2002	Ide	
D293,766 S *	1/1988	Lamb	D8/356	6,392,147 B1 *	5/2002	Hier et al.	174/70 C
4,738,817 A	4/1988	Wittwer et al.		D459,194 S	6/2002	Johansson et al.	
D298,355 S *	11/1988	Young	D24/128	6,409,131 B1	6/2002	Bentley et al.	
4,821,988 A	4/1989	Jimenez		D460,350 S	7/2002	Davis	
4,856,214 A	8/1989	Machen		6,430,782 B1	8/2002	Torres et al.	
D305,254 S	12/1989	Bateman et al.		D465,993 S	11/2002	Kelleghan	
D308,011 S *	5/1990	Norris	D8/356	6,490,789 B1	12/2002	Ide	
D314,529 S	2/1991	Willard		6,497,063 B1	12/2002	Stephens	
D317,171 S	5/1991	Saks		D477,772 S	7/2003	Nezu	
D321,913 S	11/1991	Wolff		6,598,558 B2	7/2003	Griffin	
D325,400 S	4/1992	Wolff		6,634,528 B2	10/2003	Hurtgam	
5,122,068 A	6/1992	Koss		D481,649 S	11/2003	Samuels	
5,161,799 A	11/1992	Nandra		D482,391 S	11/2003	Hui	
5,203,129 A	4/1993	Johnson		6,651,362 B2	11/2003	Caveney	
5,207,174 A	5/1993	Fabbrini		6,657,126 B2	12/2003	Ide et al.	
5,209,992 A	5/1993	Feres		6,662,445 B2	12/2003	Tanikawa et al.	
D336,131 S *	6/1993	Nordstrom et al.	D24/128	D485,783 S	1/2004	Youngman	
D340,038 S	10/1993	Venne et al.		D486,926 S	2/2004	Yuen	
D356,350 S	3/1995	Berggreen		D490,692 S	6/2004	Williams	
D358,615 S	5/1995	Cline		D491,836 S	6/2004	Haimoff	
D364,201 S	11/1995	Jensen		D492,800 S	7/2004	Yuen	
D365,781 S	1/1996	Osborn		D494,087 S	8/2004	Lax	
5,479,735 A	1/1996	Martin, Jr.		D494,090 S	8/2004	Lax	
D369,042 S	4/1996	Kinart		D494,091 S	8/2004	Lax	
D369,758 S	5/1996	Remidio		D494,092 S	8/2004	Lax	
D370,061 S *	5/1996	Shirley	D24/128	D494,093 S	8/2004	Lax	
5,536,096 A	7/1996	Nowak		6,844,499 B2	1/2005	Ide et al.	
5,537,042 A	7/1996	Beutler et al.		D502,122 S	2/2005	Lax	
D372,533 S *	8/1996	Davis	D24/128	6,858,804 B2	2/2005	Murakami et al.	
5,584,122 A	12/1996	Kato et al.		D505,091 S	5/2005	Youngman	
5,657,198 A	8/1997	Flener		D505,356 S	5/2005	Ho	
5,669,191 A	9/1997	Weaver		D507,508 S	7/2005	Brownell	
D388,833 S	1/1998	Wilson		6,940,020 B2	9/2005	Ide et al.	
5,712,767 A	1/1998	Koizumi		D511,709 S	11/2005	Mehta	
D390,066 S *	2/1998	Watkins et al.	D7/633	D511,987 S	11/2005	Swarovski	
D393,345 S	4/1998	Clegg et al.		D511,989 S	11/2005	Pereira De Castro et al.	
5,740,622 A	4/1998	Martin		D512,934 S	12/2005	Voorn	
D396,146 S	7/1998	Blue		D514,978 S	2/2006	Lakhi	
D401,883 S	12/1998	Madhvani		D520,676 S	5/2006	Chen	
5,845,883 A	12/1998	Meyer		D521,409 S	5/2006	De Castro et al.	
				7,073,282 B2	7/2006	Savagian et al.	
				7,111,812 B2	9/2006	Shannon et al.	
				D529,557 S	10/2006	Greenwald	
				D534,594 S	1/2007	Revere	











Sunlec International, <http://www.sunlec.com.au>, Sunlec International Cable Sleeves, Accessed Nov. 26, 2010.

The Cable Label Co., <http://www.thecablelabelco.co.uk/buy.php>, Buy Cable Bug Labels In Bags, Accessed Nov. 26, 2010.

The Storage Store, <http://www.thestoragestore.com>, Computer Cable Flags, Accessed Nov. 26, 2010.

Non-final Office Action entered by the U.S. Patent and Trademark Office on Mar. 6, 2012 for U.S. Appl. No. 29/411,283, filed Jan. 19, 2012 (First Named Inventor—Dunn) (5 pages).

Non-final Office Action entered by the U.S. Patent and Trademark Office on Mar. 26, 2012 for U.S. Appl. No. 29/411,284, filed Jan. 19, 2012 (First Named Inventor—Dunn) (5 pages).

Notice of Allowance and Fees Due entered by the U.S. Patent and Trademark Office on Mar. 6, 2012 for U.S. Appl. No. 29/411,288, filed Jan. 19, 2012 (First Named Inventor—Dunn) (7 pages).

Notice of Allowance entered by the U.S. Patent and Trademark Office on Apr. 4, 2012 for U.S. Appl. No. 29/411,291, filed Jan. 19, 2012 (First Named Inventor—Dunn) (7 pages).

Notice of Allowance entered by the U.S. Patent and Trademark Office on Apr. 4, 2012 for U.S. Appl. No. 29/411,293, filed Jan. 19, 2012 (First Named Inventor—Dunn) (7 pages).

Notice of Allowance and Fees Due entered by the U.S. Patent and Trademark Office on Mar. 20, 2012 for U.S. Appl. No. 29/411,296, filed Jan. 19, 2012 (First Named Inventor—Dunn) (7 pages).

Notice of Allowance entered by the U.S. Patent and Trademark Office on Apr. 2, 2012 for U.S. Appl. No. 29/411,298, filed Jan. 19, 2012 (First Named Inventor—Dunn) (7 pages).

Notice of Allowance entered by the U.S. Patent and Trademark Office on Apr. 2, 2012 for U.S. Appl. No. 29/411,300, filed Jan. 19, 2012 (First Named Inventor—Dunn) (7 pages).

Office Action entered by the U.S. Patent and Trademark Office on Mar. 30, 2012 for U.S. Appl. No. 29/411,309, filed Jan. 19, 2012 (First Named Inventor—Dunn) (6 pages).

Specification, Claims, and Drawings entered by the U.S. Patent and Trademark Office on Jan. 19, 2012 for U.S. Appl. No. 29/411,277, filed Jan. 19, 2012 (First Named Inventor—Dunn) (7 pages).

Notice of Allowance and Fees Due entered by the U.S. Patent and Trademark Office on Mar. 2, 2012 for U.S. Appl. No. 29/411,277, filed Jan. 19, 2012 (First Named Inventor—Dunn) (7 pages).

Specification, Claims, and Drawings entered by the U.S. Patent and Trademark Office on Jan. 19, 2012 for U.S. Appl. No. 29/411,282, filed Jan. 19, 2012 (First Named Inventor—Dunn) (8 pages).

Notice of Allowance entered by the U.S. Patent and Trademark Office on Apr. 2, 2012 for U.S. Appl. No. 29/411,297, filed Jan. 19, 2012 (First Named Inventor—Dunn) (7 pages).

Notice of Allowance entered by the U.S. Patent and Trademark Office on Apr. 4, 2012 for U.S. Appl. No. 29/411,311, filed Jan. 19, 2012 (First Named Inventor—Dunn) (7 pages).

U.S. Appl. No. 29/411,302, Dunn.

U.S. Appl. No. 29/411,309, Dunn.

U.S. Appl. No. 29/411,311, Dunn.

U.S. Appl. No. 29/411,313, Dunn.

U.S. Appl. No. 29/411,316, Dunn.

U.S. Appl. No. 29/394,588, filed Jun. 18, 2011, Scott E. Dunn.

U.S. Appl. No. 29/394,589, filed Jun. 18, 2011, Scott E. Dunn.

U.S. Appl. No. 29/394,590, filed Jun. 18, 2011, Scott E. Dunn.

U.S. Appl. No. 29/394,591, filed Jun. 18, 2011, Scott E. Dunn.

U.S. Appl. No. 29/394,592, filed Jun. 18, 2011, Scott E. Dunn.

U.S. Appl. No. 29/394,593, filed Jun. 18, 2011, Scott E. Dunn.

U.S. Appl. No. 29/394,594, filed Jun. 18, 2011, Scott E. Dunn.

U.S. Appl. No. 29/394,595, filed Jun. 18, 2011, Scott E. Dunn.

U.S. Appl. No. 29/394,596, filed Jun. 18, 2011, Scott E. Dunn.

U.S. Appl. No. 29/394,597, filed Jun. 18, 2011, Scott E. Dunn.

U.S. Appl. No. 29/394,598, filed Jun. 18, 2011, Scott E. Dunn.

U.S. Appl. No. 29/394,599, filed Jun. 18, 2011, Scott E. Dunn.

U.S. Appl. No. 29/394,600, filed Jun. 18, 2011, Scott E. Dunn.

U.S. Appl. No. 29/411,277, filed Jan. 19, 2012, Scott E. Dunn.

U.S. Appl. No. 29/411,282, filed Jan. 19, 2012, Scott E. Dunn.

U.S. Appl. No. 29/411,283, filed Jan. 19, 2012, Scott E. Dunn.

U.S. Appl. No. 29/411,284, filed Jan. 19, 2012, Scott E. Dunn.

U.S. Appl. No. 29/411,285, filed Jan. 19, 2012, Scott E. Dunn.

U.S. Appl. No. 29/411,286, filed Jan. 19, 2012, Scott E. Dunn.

U.S. Appl. No. 29/411,288, filed Jan. 19, 2012, Scott E. Dunn.

U.S. Appl. No. 29/411,291, filed Jan. 19, 2012, Scott E. Dunn.

U.S. Appl. No. 29/411,293, filed Jan. 19, 2012, Scott E. Dunn.

U.S. Appl. No. 29/411,295, filed Jan. 19, 2012, Scott E. Dunn.

U.S. Appl. No. 29/411,296, filed Jan. 19, 2012, Scott E. Dunn.

U.S. Appl. No. 29/411,297, filed Jan. 19, 2012, Scott E. Dunn.

U.S. Appl. No. 29/411,298, filed Jan. 19, 2012, Scott E. Dunn.

U.S. Appl. No. 29/411,300, filed Jan. 19, 2012, Scott E. Dunn.

U.S. Appl. No. 29/411,302, filed Jan. 19, 2012, Scott E. Dunn.

U.S. Appl. No. 29/411,309, filed Jan. 19, 2012, Scott E. Dunn.

U.S. Appl. No. 29/411,311, filed Jan. 19, 2012, Scott E. Dunn.

U.S. Appl. No. 29/411,313, filed Jan. 19, 2012, Scott E. Dunn.

U.S. Appl. No. 29/411,316, filed Jan. 19, 2012, Scott E. Dunn.

Notice of Allowance and Fees Due entered on Mar. 25, 2013 for U.S.

Appl. No. 29/411,284, filed Jan. 19, 2012 (6 pages).

Notice of Allowance and Fees Due entered on Mar. 27, 2013 for U.S.

Appl. No. 29/411,283, filed Jan. 19, 2012 (6 pages).

Notice of Allowance and Fees Due entered on Mar. 26, 2013 for U.S.

Appl. No. 29/411,309, filed Jan. 19, 2012 (6 pages).

Non-Final Office Action entered Mar. 19, 2013 for U.S. Appl. No.

29/431,160, filed Sep. 4, 2012 (8 pages).

Amendment After Final entered on Mar. 27, 2013 for U.S. Appl. No.

29/430,979, filed Aug. 31, 2012 (3 pages).

Amendment After Final entered on Mar. 27, 2013 for U.S. Appl. No.

29/431,031, filed Aug. 31, 2012 (3 pages).

Supplemental Notice of Allowability entered on May 20, 2013 for

U.S. Appl. No. 29/431,031, filed Aug. 31, 2012 (2 pages).

\* cited by examiner

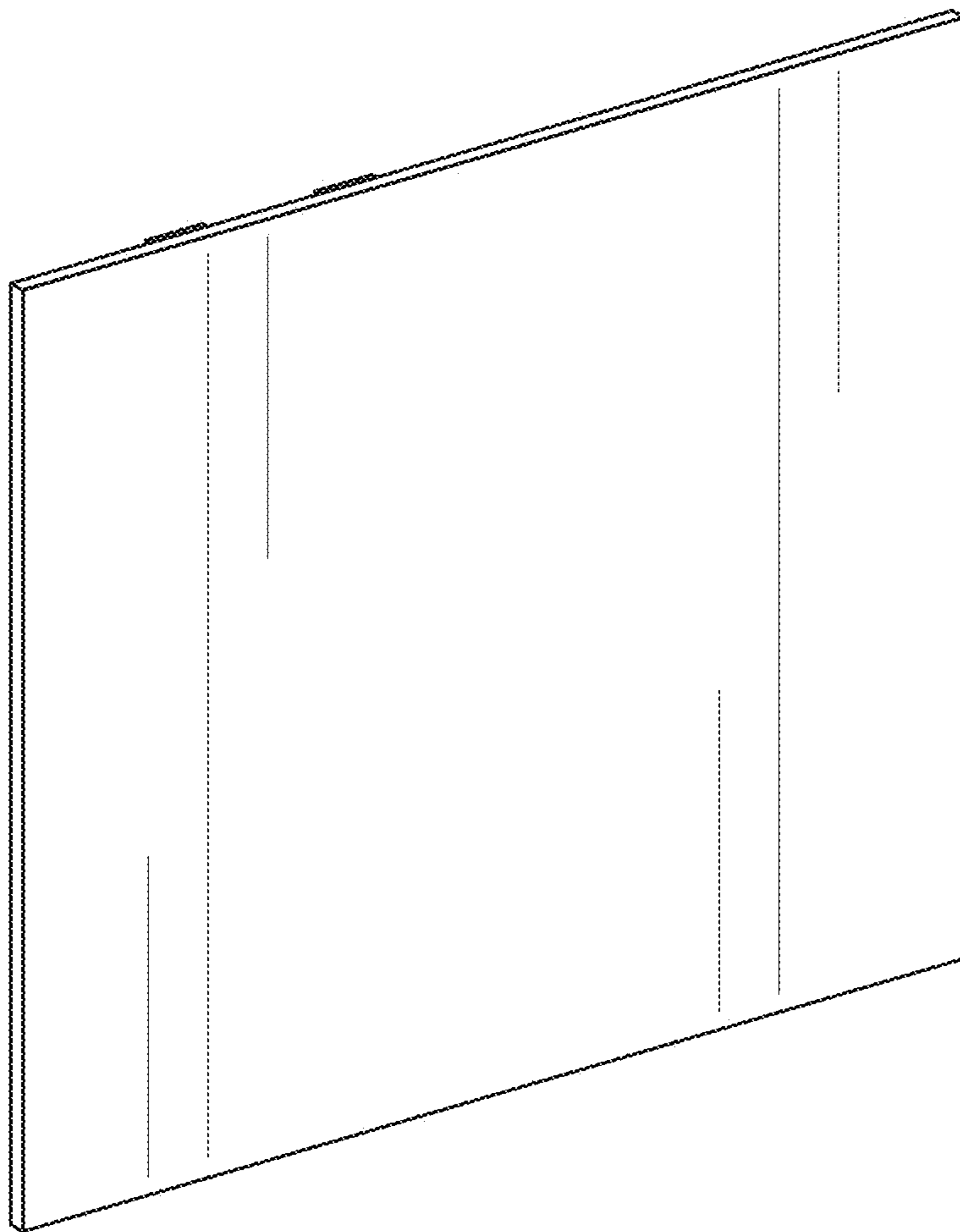

FIG. 1

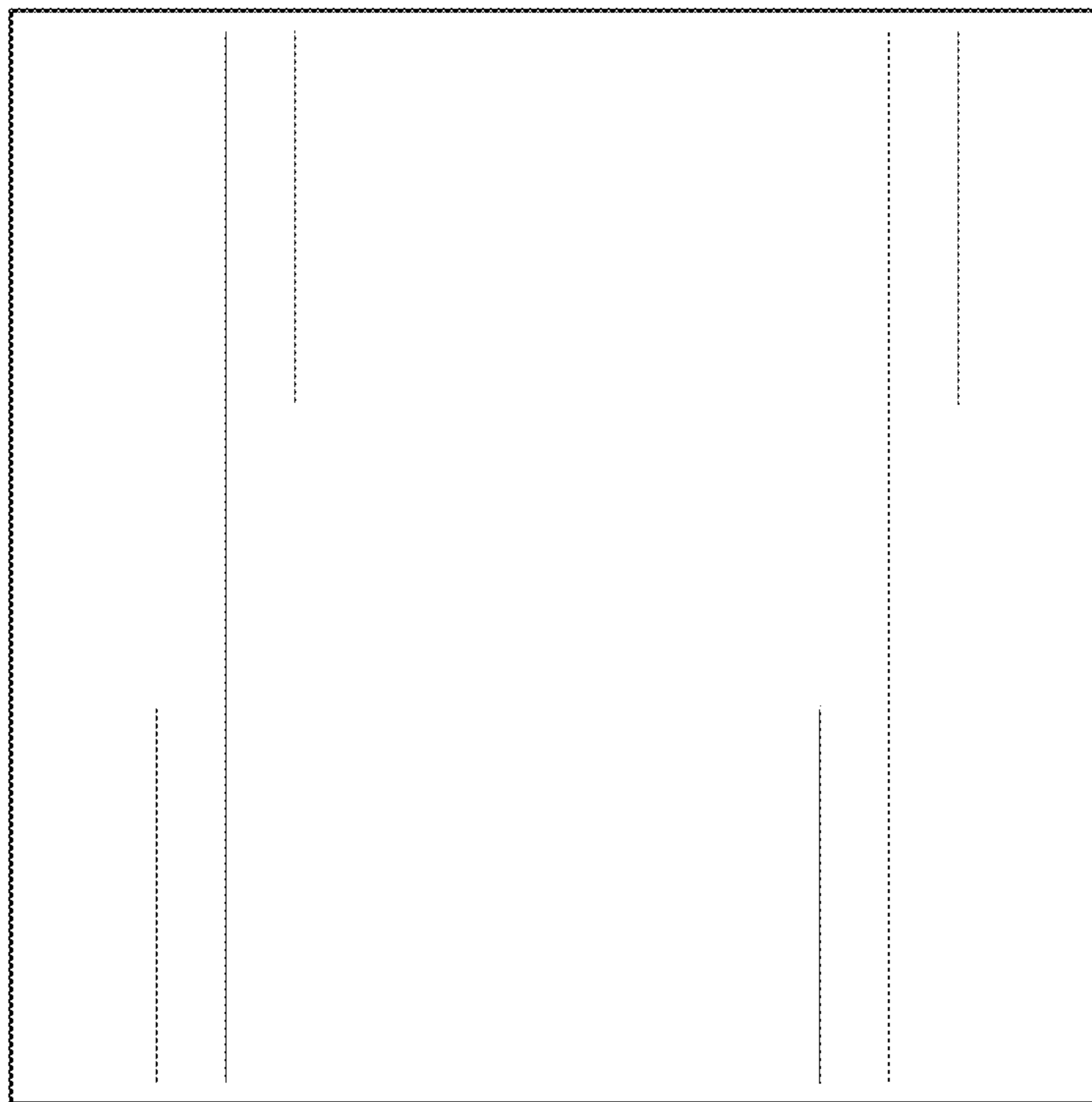

FIG. 2

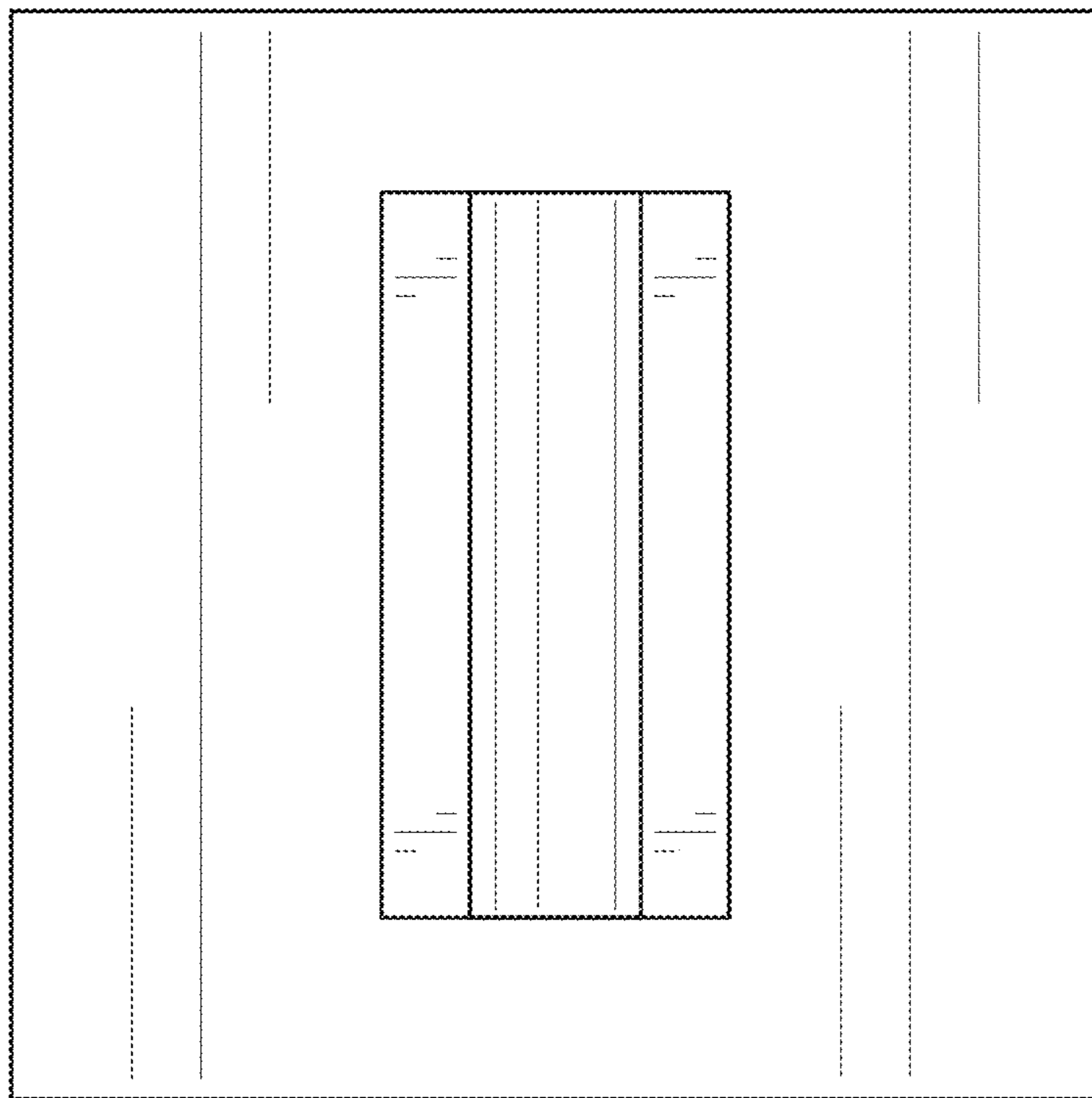

FIG. 3



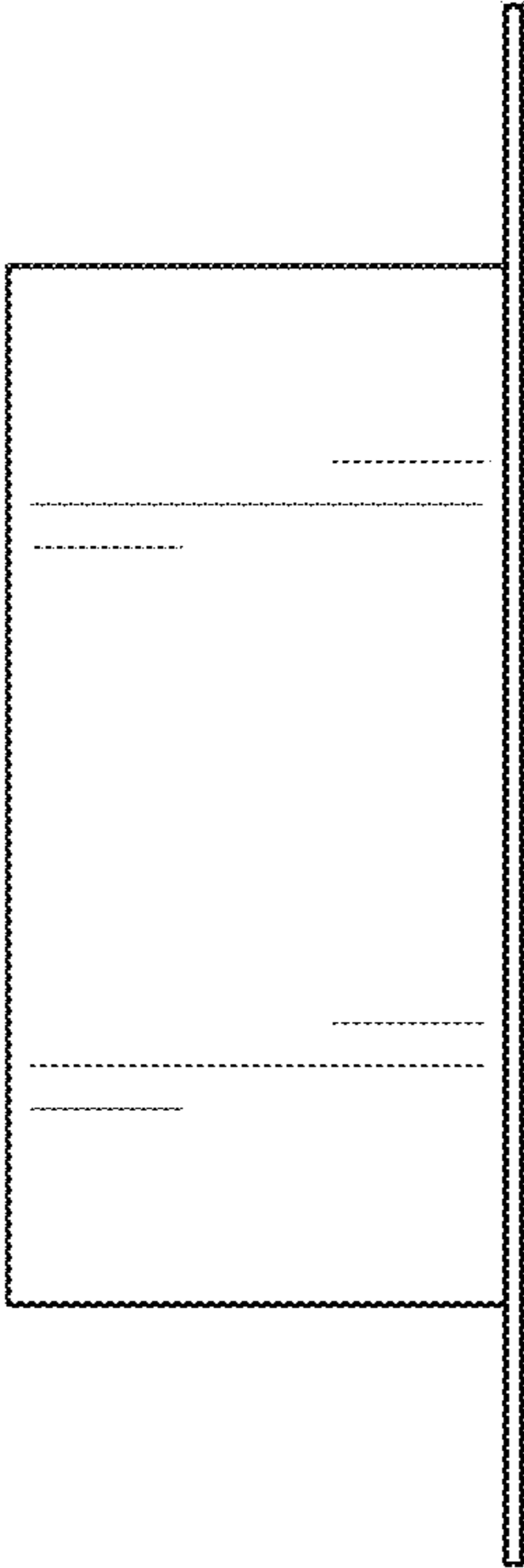

FIG. 4

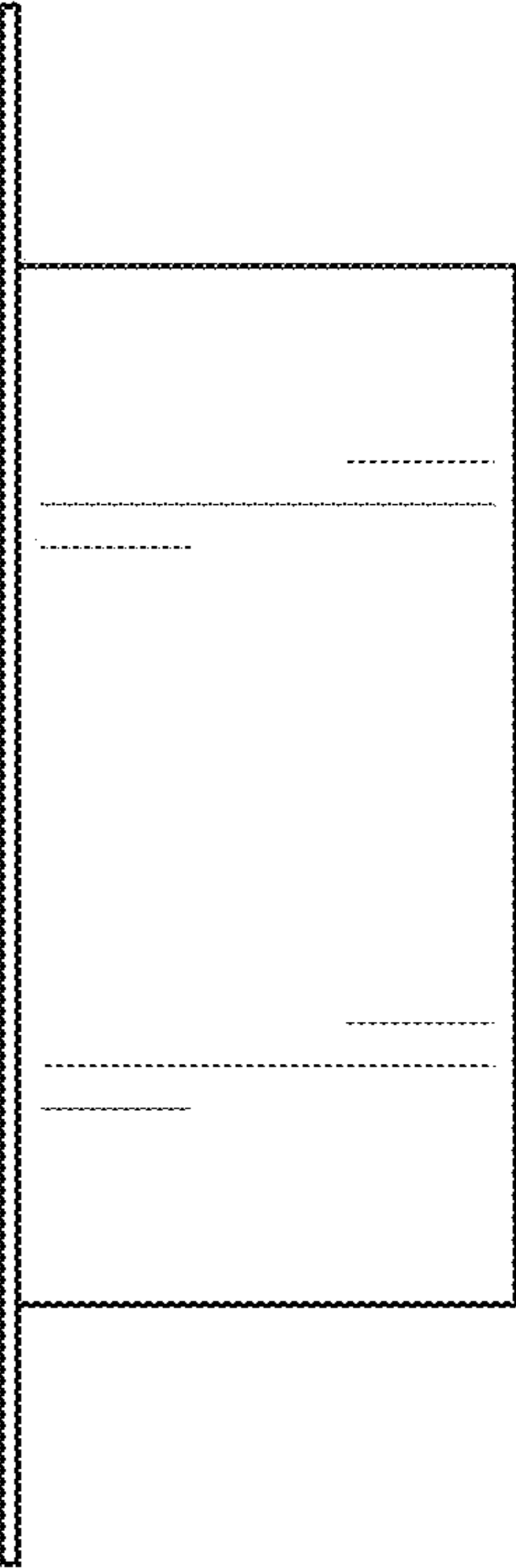

FIG. 5

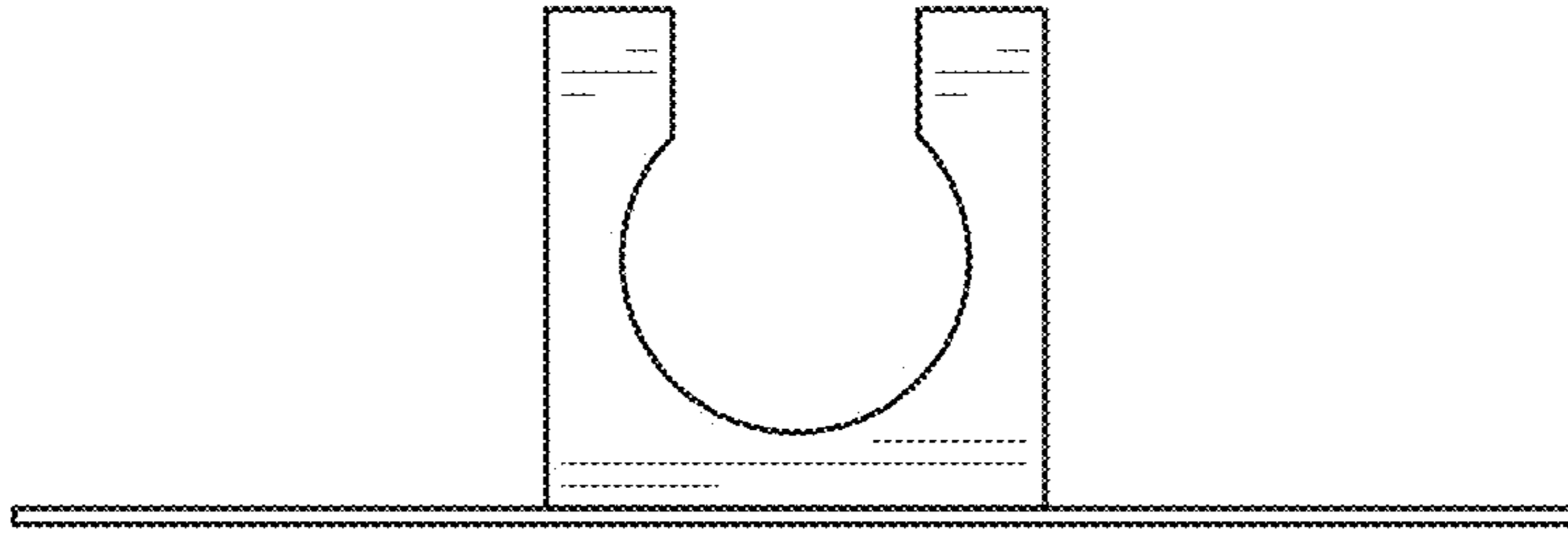

FIG. 6

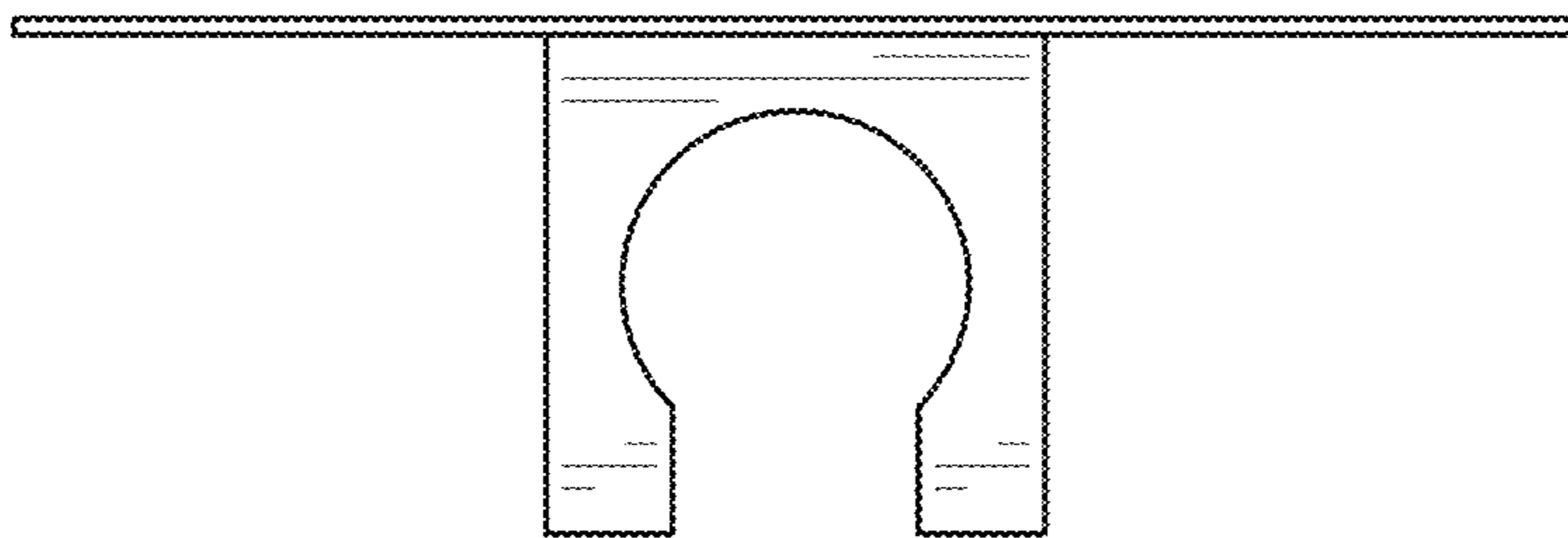

FIG. 7



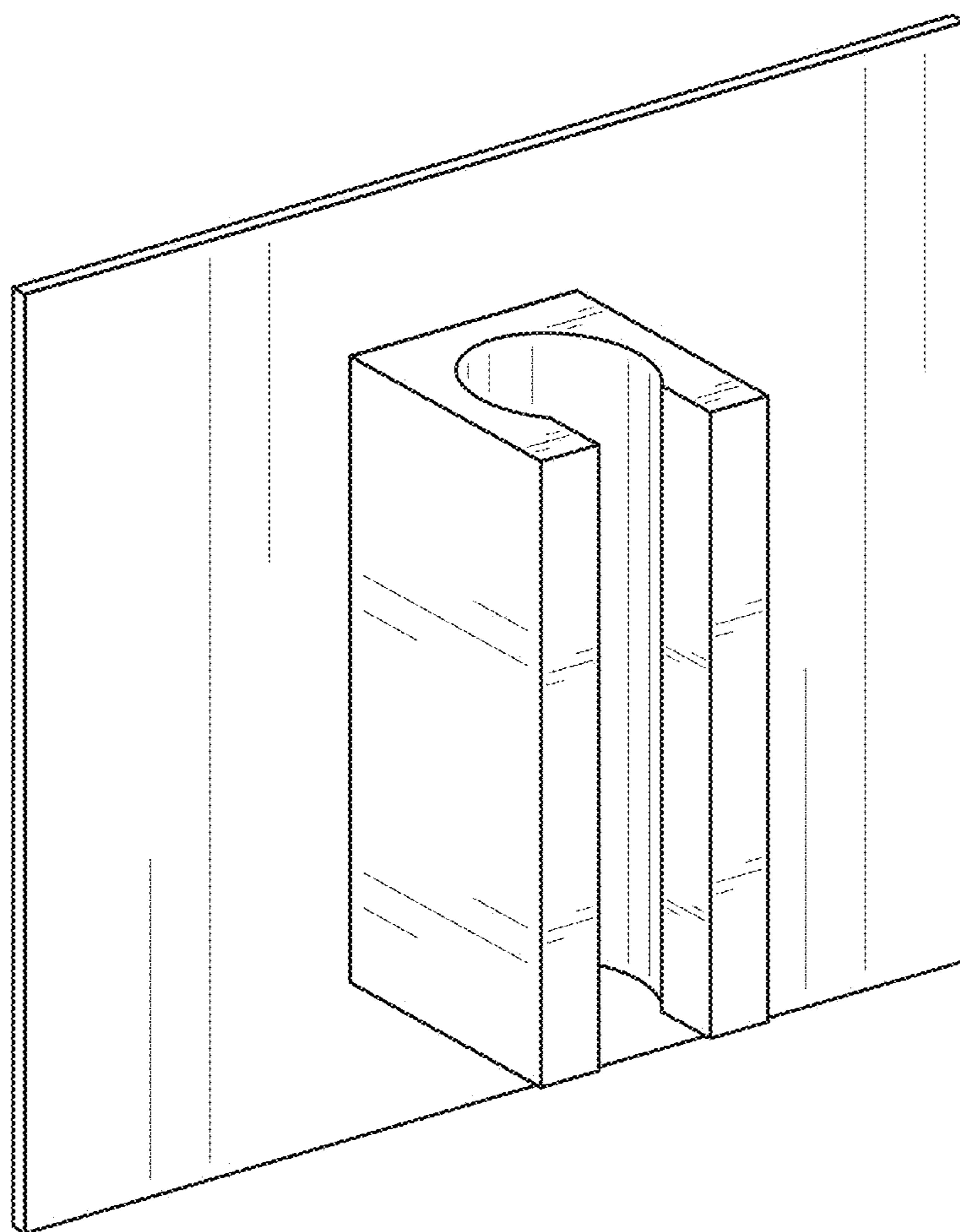

FIG. 8