



US00D688415S

(12) **United States Design Patent**
Kim

(10) **Patent No.:** **US D688,415 S**

(45) **Date of Patent:** **** Aug. 20, 2013**

(54) **E-CIGARETTE**

(75) Inventor: **Hyung Yoon Kim**, Uijeongbu-si (KR)

(73) Assignee: **Needs Co., Ltd.**, Uijeongbu-si (KR)

(**) Term: **14 Years**

(21) Appl. No.: **29/425,077**

(22) Filed: **Jun. 20, 2012**

(30) **Foreign Application Priority Data**

Dec. 22, 2011 (KR) 30-2011-0054817

(51) **LOC (9) Cl.** **27-01**

(52) **U.S. Cl.**
USPC **D27/101**

(58) **Field of Classification Search**
USPC D27/100, 101, 163, 164, 167, 169,
D27/172, 183, 186, 187, 189, 191, 193, 194;
D9/713, 714; 131/329, 347, 348, 328, 361
See application file for complete search history.

(56) **References Cited**

U.S. PATENT DOCUMENTS

D590,990 S * 4/2009 Hon D27/101
D644,375 S * 8/2011 Zhou D27/101
D652,571 S * 1/2012 Shenassa et al. D27/163
D653,803 S * 2/2012 Timmermans D27/163
D662,257 S * 6/2012 Alelov D27/101

8,205,622 B2 * 6/2012 Pan 131/273
D666,355 S * 8/2012 Alelov D27/101
2012/0167906 A1 * 7/2012 Gysland 131/328
2012/0260926 A1 * 10/2012 Tu et al. 131/329

OTHER PUBLICATIONS

CE4 Plus Clearomizer, [online], [site visited Dec. 6, 2012]. Available from Internet, <URL: <http://www.esco-e-cigarette.com>>.*

* cited by examiner

Primary Examiner — Robert M Spear

Assistant Examiner — Janice Hallmark

(74) *Attorney, Agent, or Firm* — Novick, Kim & Lee, PLLC;
Jae Youn Kim

(57) **CLAIM**

The ornamental design for an e-cigarette, as shown and described.

DESCRIPTION

FIG. 1 is a perspective view of an e-cigarette, showing my new design;
FIG. 2 is a front view thereof;
FIG. 3 is a rear view thereof;
FIG. 4 is a left view thereof;
FIG. 5 is a right view thereof;
FIG. 6 is a top view thereof;
FIG. 7 is a bottom view thereof; and,
FIG. 8 is an exploded view thereof.

1 Claim, 8 Drawing Sheets



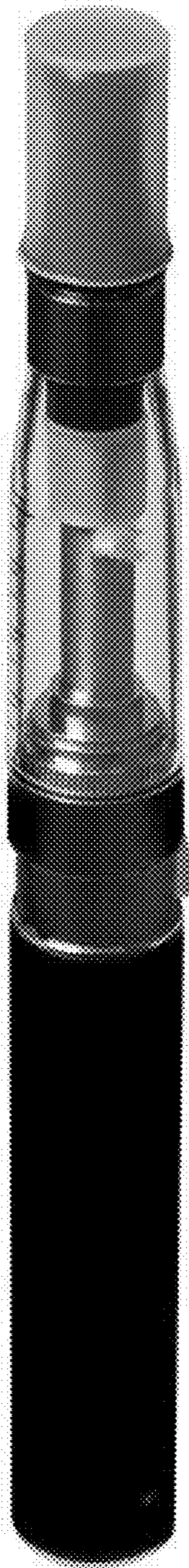

Fig. 1

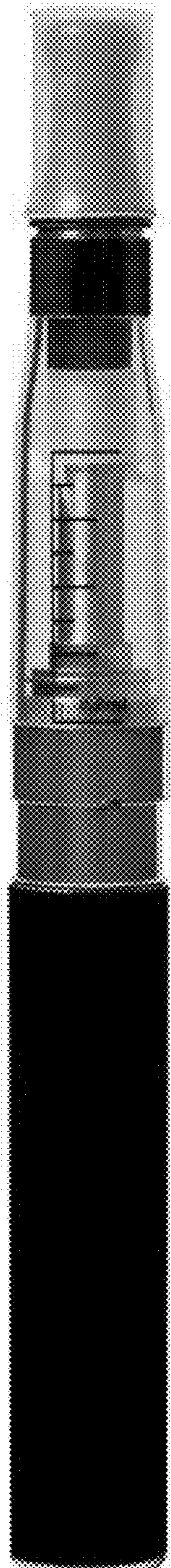

Fig. 2

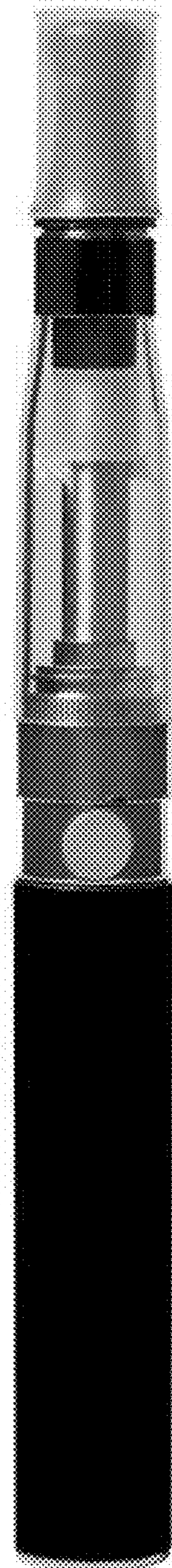

Fig. 3

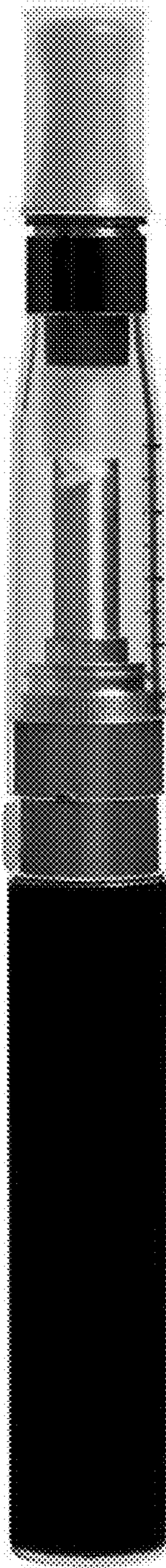

Fig. 4

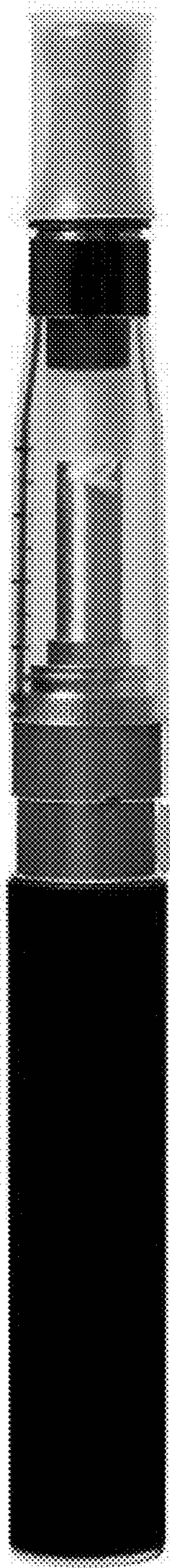

Fig. 5

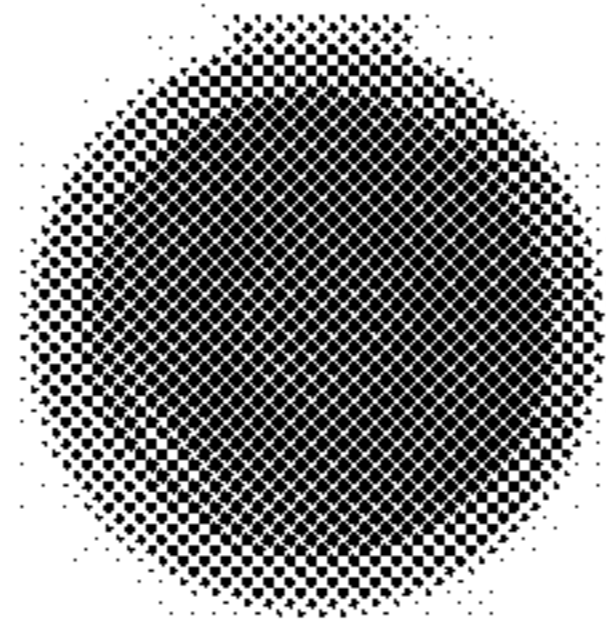

Fig. 6

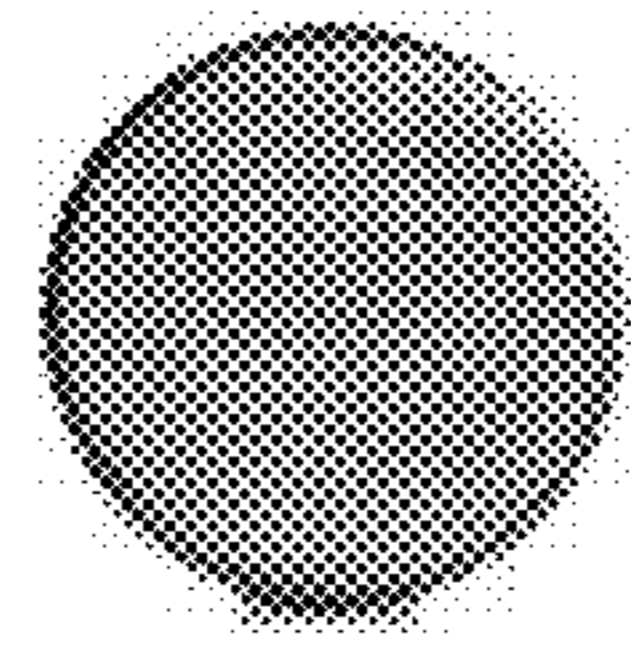

Fig. 7

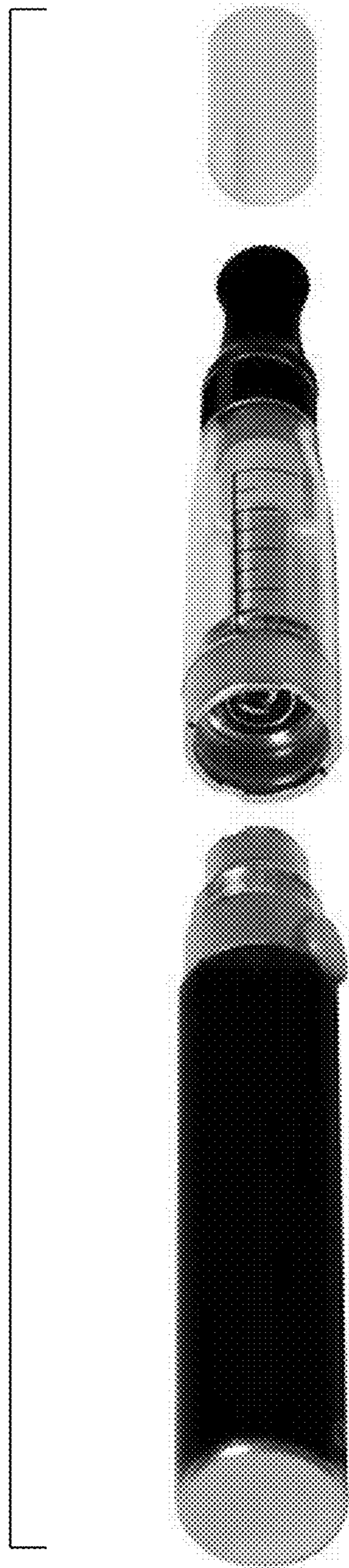

Fig. 8