

US00D688404S

(12) **United States Design Patent**  
**Boissevain et al.**

(10) **Patent No.:** **US D688,404 S**

(45) **Date of Patent:** **\*\* Aug. 20, 2013**

(54) **LUMINAIRE FOR ROAD LIGHTING**

(56) **References Cited**

(75) Inventors: **Christopher James Boissevain**, San Marcos, TX (US); **Mason James Morton**, Wimberley, TX (US); **Charles Havers**, Randolph, NJ (US); **William E. Budzileni**, New Braunfels, TX (US); **John William Schach**, Kyle, TX (US)

U.S. PATENT DOCUMENTS

D195,310	S	*	5/1963	Zagel	.....	D26/70
D195,583	S	*	7/1963	Phillips	.....	D26/71
6,459,384	B1	*	10/2002	Wahlin	.....	340/907
D601,292	S	*	9/2009	Yan et al.	.....	D26/71
7,832,898	B2	*	11/2010	Li	.....	362/249.02
D629,152	S	*	12/2010	Laporte	.....	D26/120
D629,953	S	*	12/2010	Laporte	.....	D26/71
D634,878	S	*	3/2011	Guercio et al.	.....	D26/85
D652,557	S	*	1/2012	Boissevain et al.	.....	D26/71
D656,267	S	*	3/2012	Laporte	.....	D26/120
D660,496	S	*	5/2012	Akdag et al.	.....	D26/71
D664,697	S	*	7/2012	Piano	.....	D26/71
D666,347	S	*	8/2012	Kim et al.	.....	D26/71

(73) Assignee: **Koninklijke Philips N.V.**, Eindhoven (NL)

(\*\*) Term: **14 Years**

\* cited by examiner

(21) Appl. No.: **29/417,152**

*Primary Examiner* — Clare E Heflin

(22) Filed: **Mar. 30, 2012**

(57) **CLAIM**

(30) **Foreign Application Priority Data**

The ornamental design for a luminaire for road lighting, as shown.

Sep. 30, 2011 (EM) ..... 001925272-0002

**DESCRIPTION**

(51) **LOC (9) Cl.** ..... **26-05**

FIG. 1 is a perspective view showing my design;  
FIG. 2 is a front elevational view thereof;  
FIG. 3 is a rear elevational view thereof;  
FIG. 4 is a right side elevational view thereof;  
FIG. 5 is a left side elevational view thereof;  
FIG. 6 is a top plan view thereof; and,  
FIG. 7 is a bottom plan view thereof.

(52) **U.S. Cl.**

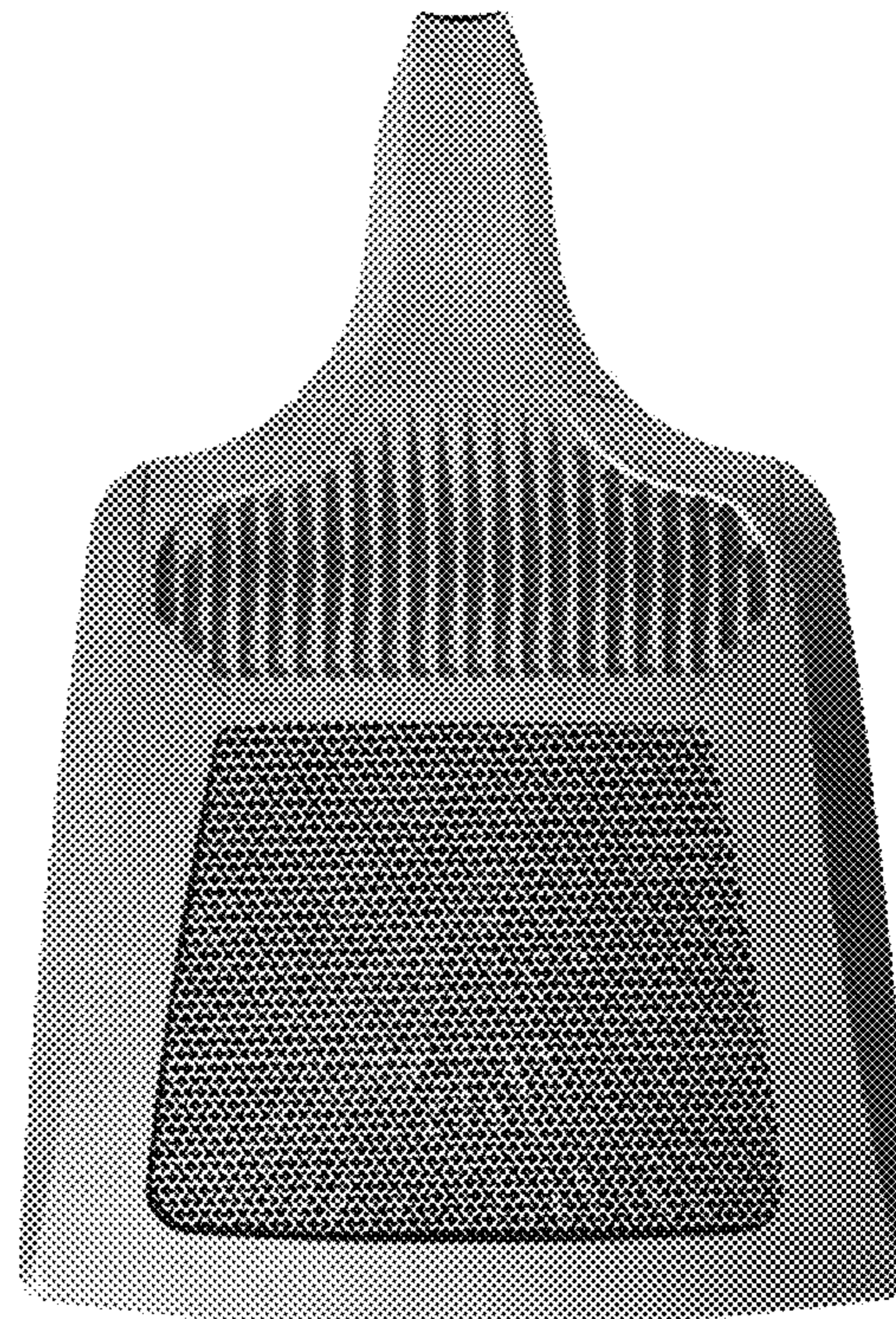
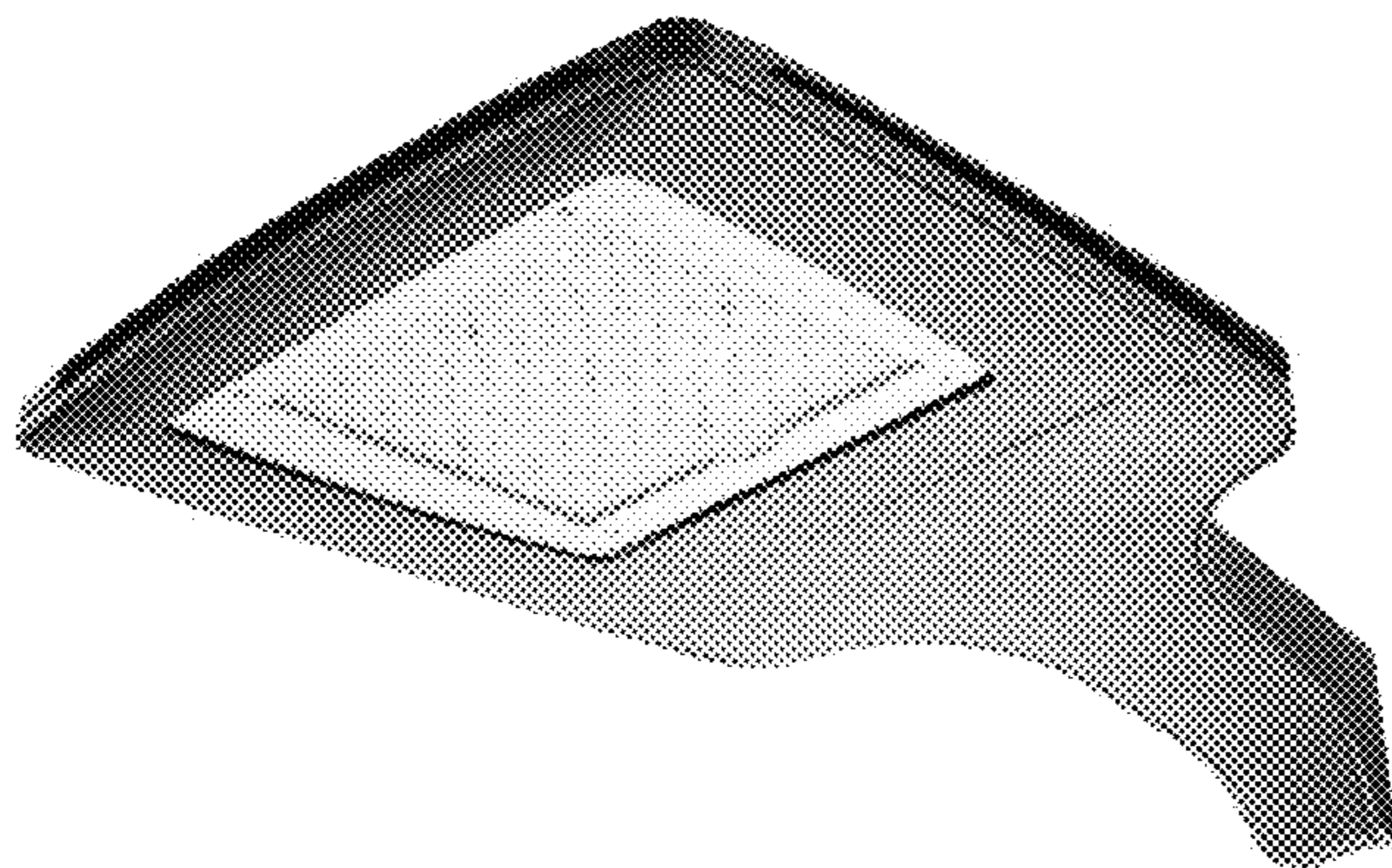
USPC ..... **D26/71; D26/92**

(58) **Field of Classification Search**

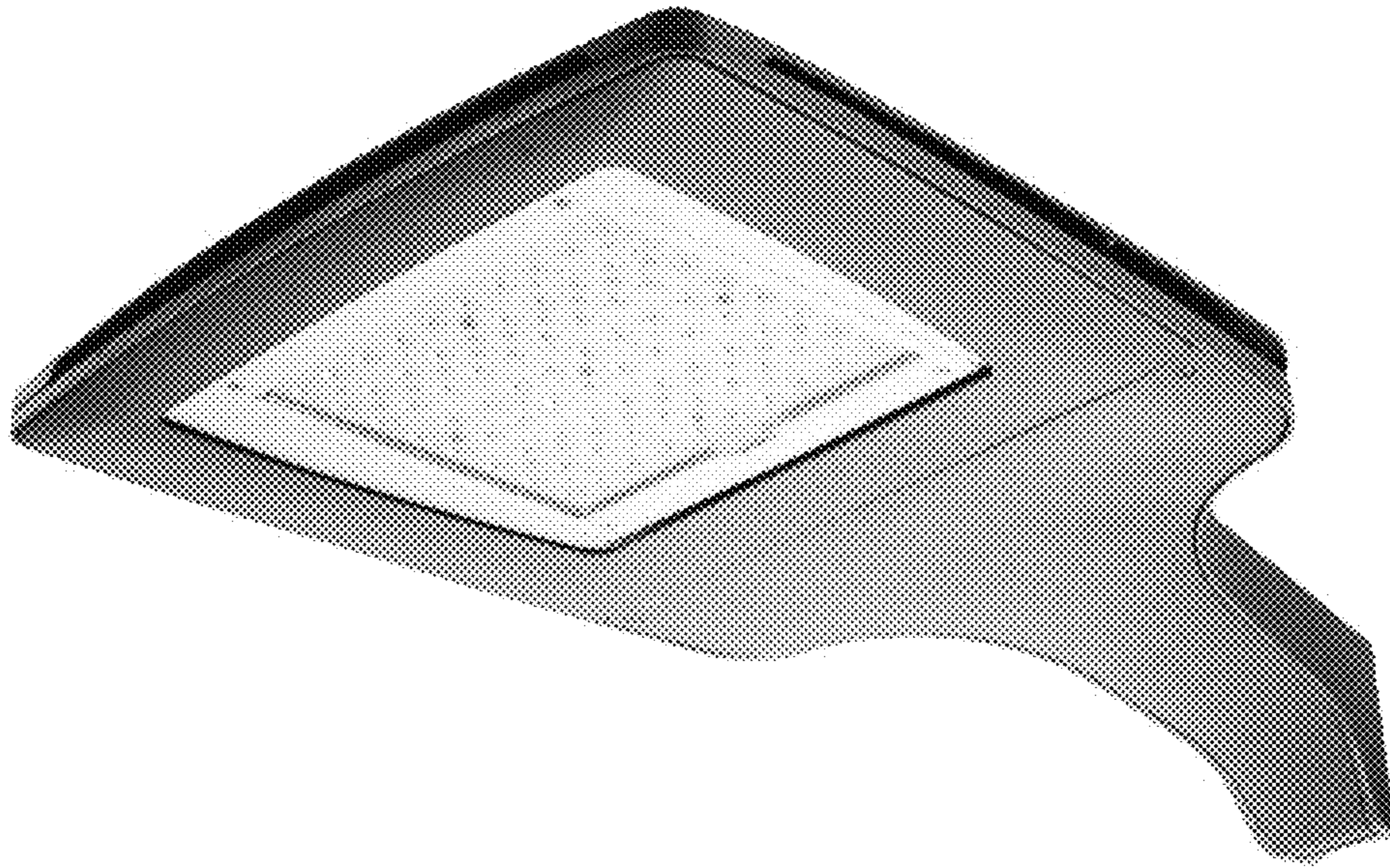
USPC ..... D26/63, 67-71, 92, 118, 120, 138;  
362/249.01-249.06, 294, 373, 431

See application file for complete search history.

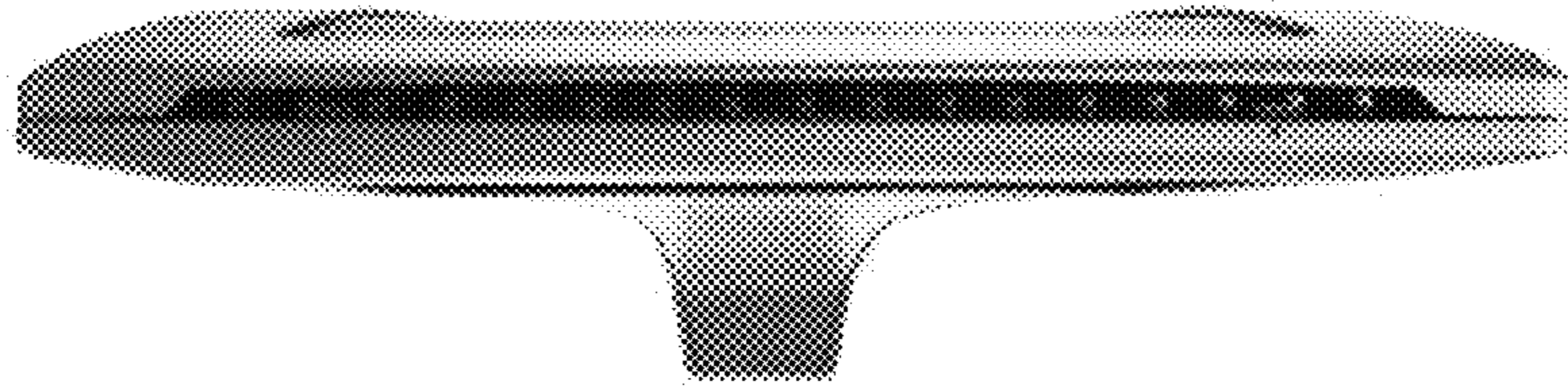
**1 Claim, 5 Drawing Sheets**



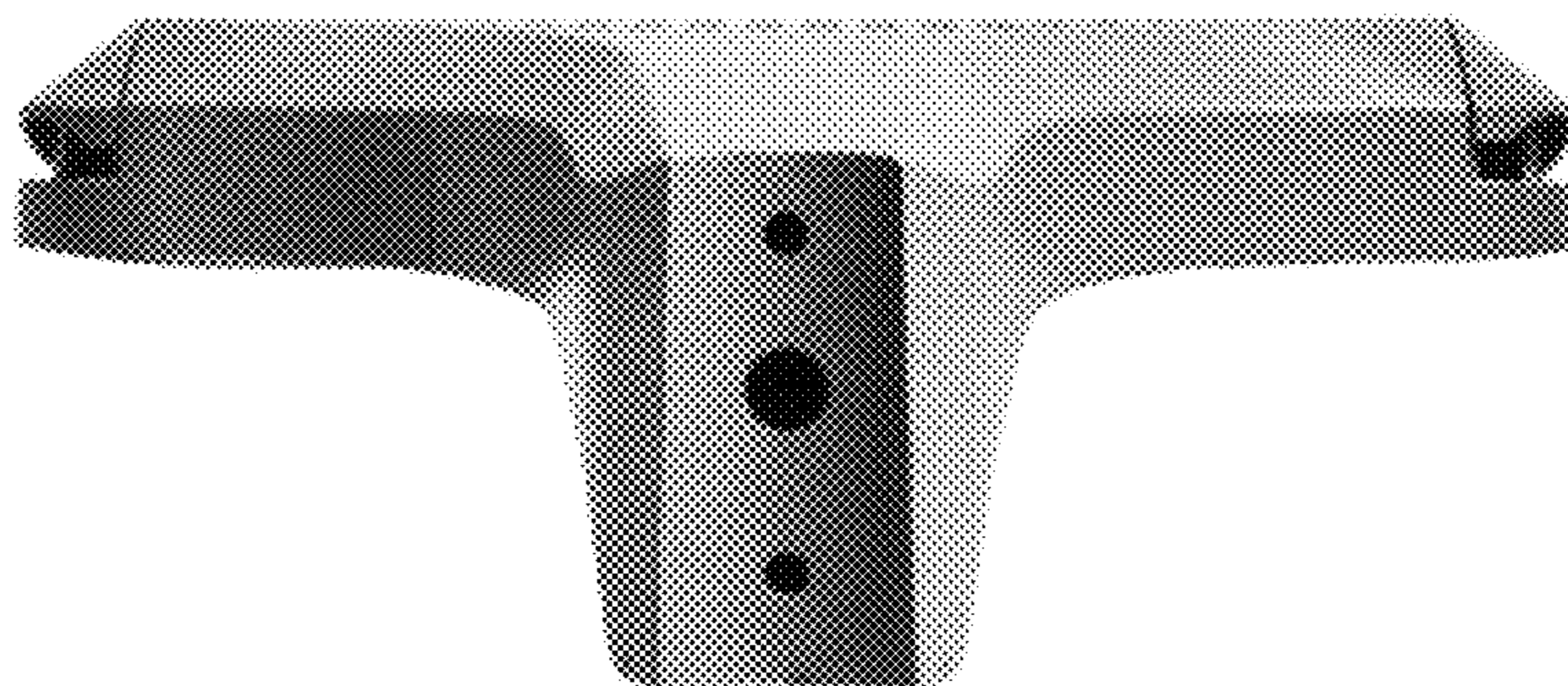




**FIG. 1**



**FIG. 2**



**FIG. 3**

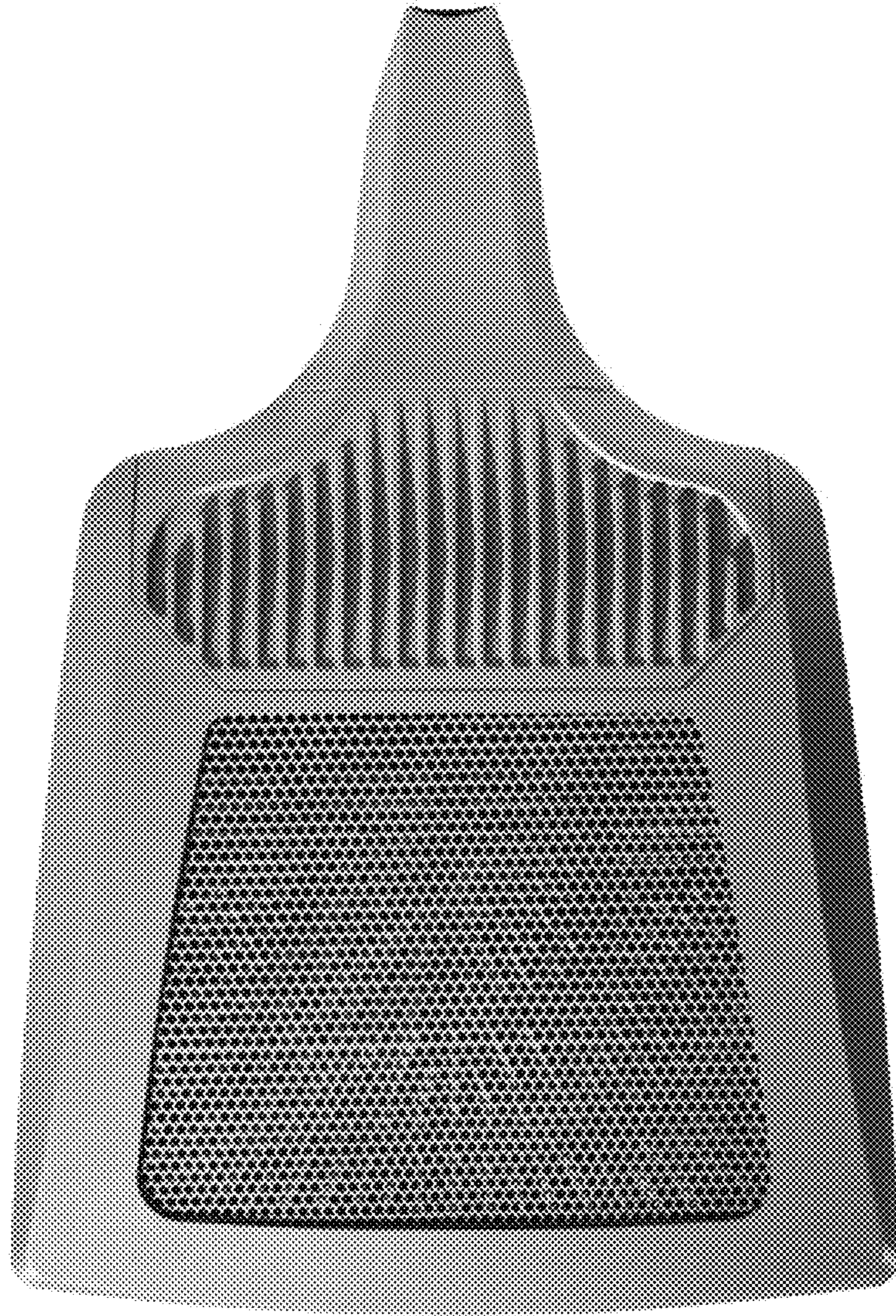


**FIG. 4**



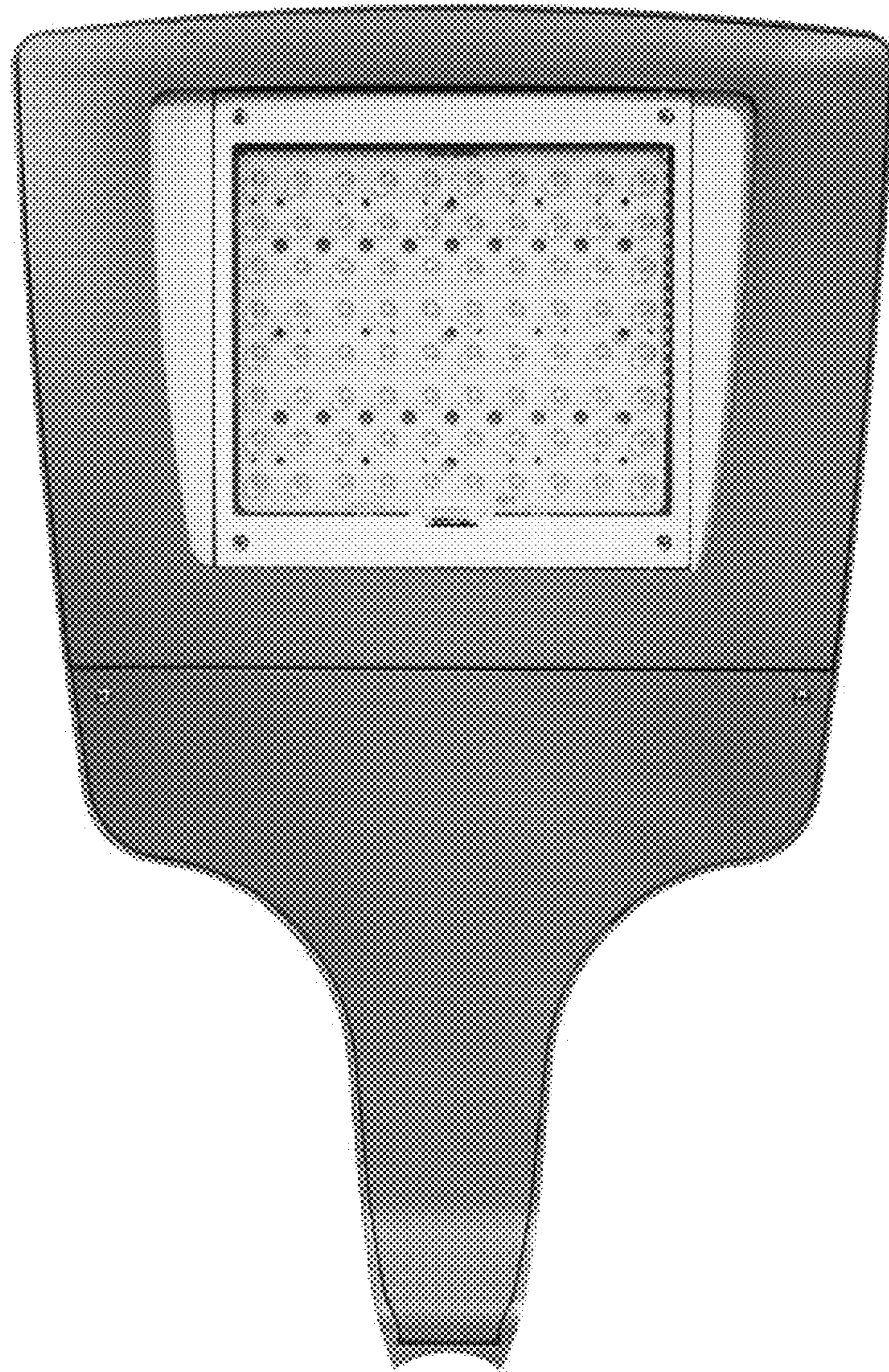
**FIG. 5**





**FIG. 6**





**FIG. 7**