



US00D688380S

(12) **United States Design Patent**
Nelson

(10) **Patent No.:** **US D688,380 S**

(45) **Date of Patent:** **** Aug. 20, 2013**

(54) **MESSAGE ROLLER**

(71) Applicant: **Jeremy J. Nelson**, Boulder, CO (US)

(72) Inventor: **Jeremy J. Nelson**, Boulder, CO (US)

(73) Assignee: **Roll Recovery, LLC**, Boulder, CO (US)

(**) Term: **14 Years**

(21) Appl. No.: **29/435,812**

(22) Filed: **Oct. 29, 2012**

(51) **LOC (9) Cl.** **28-03**

(52) **U.S. Cl.**
USPC **D24/211**

(58) **Field of Classification Search**
USPC D24/200, 211, 212, 213, 214, 215;
601/114, 120, 121, 124, 125, 130, 131, 134,
601/135, 136, 137
See application file for complete search history.

(56) **References Cited**

U.S. PATENT DOCUMENTS

1,999,939 A * 4/1935 Luzzi 601/125
D353,008 S * 11/1994 Van Harn D24/211
D384,161 S * 9/1997 Tseng D24/215

D491,271 S * 6/2004 Siegfried D24/211
D491,671 S * 6/2004 Kim D24/211
D639,974 S * 6/2011 Kurosu et al. D24/211
D646,793 S * 10/2011 Wagner D24/211

* cited by examiner

Primary Examiner — Sandra Snapp

(74) *Attorney, Agent, or Firm* — Craig R. Miles; CR Miles P.C.

(57) **CLAIM**

We claim the ornamental design for a massage roller, as shown and described.

DESCRIPTION

FIG. 1 is a top and right side perspective of a massage roller, embodying our new design;
FIG. 2 is a front elevation view thereof;
FIG. 3 is a rear elevation view thereof;
FIG. 4 is a left side elevation view thereof;
FIG. 5 is a right side elevation view thereof;
FIG. 6 is a top plan view thereof; and,
FIG. 7 is a bottom plan view thereof.
The broken lines shown are included for the purpose of illustrating the unclaimed portions of the article and form no part of the claim.

1 Claim, 5 Drawing Sheets

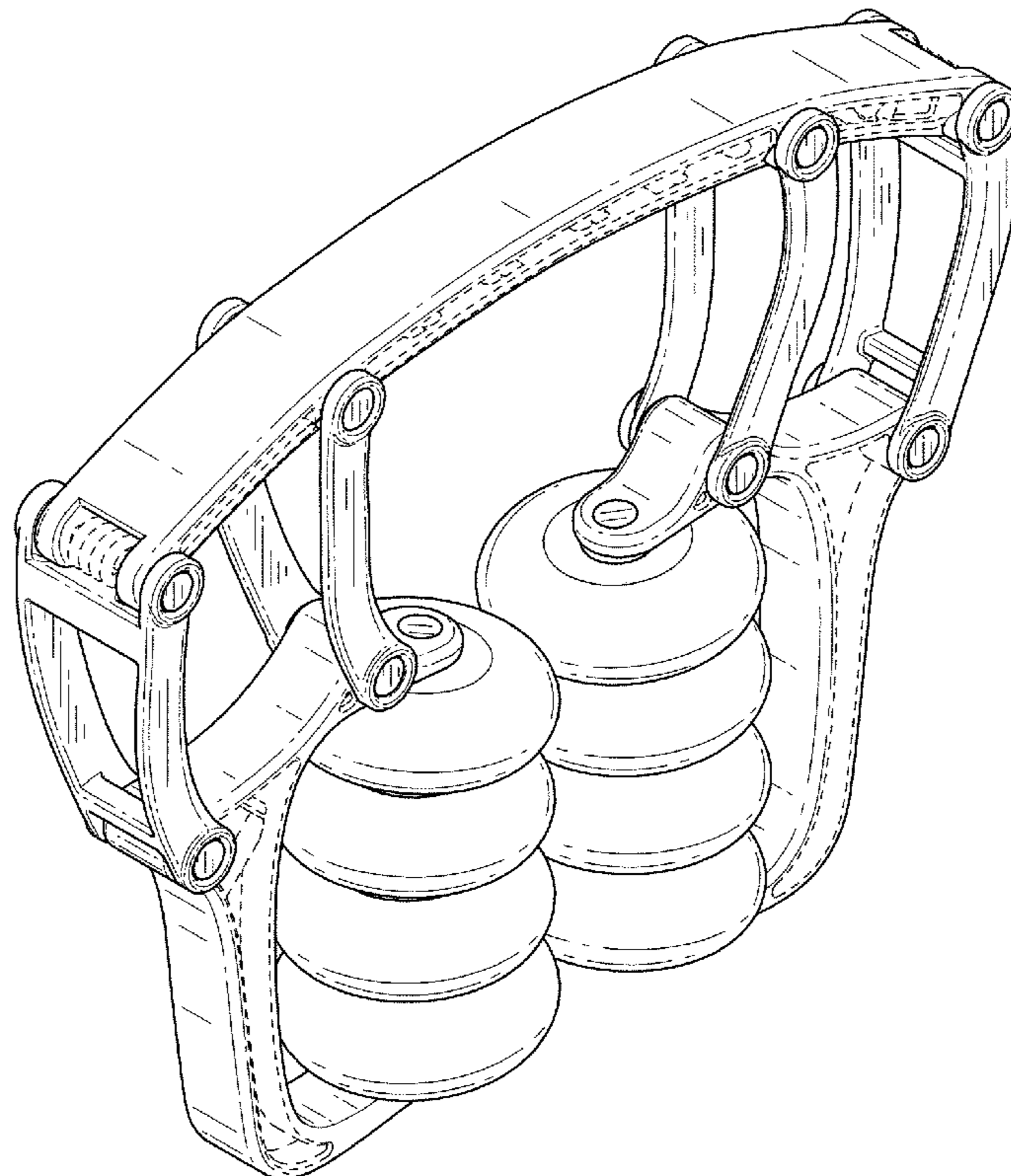

FIG. 1

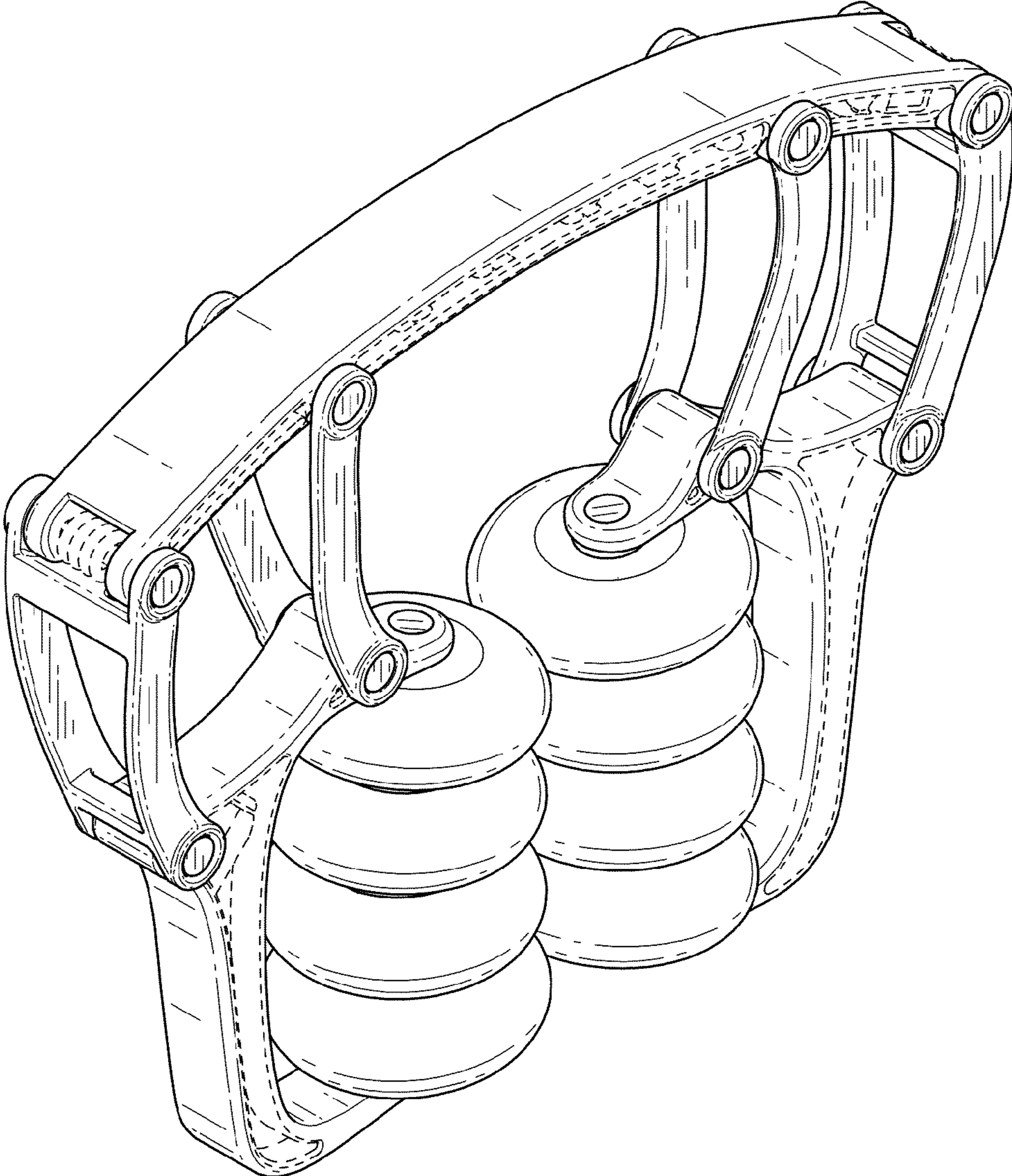

FIG. 2

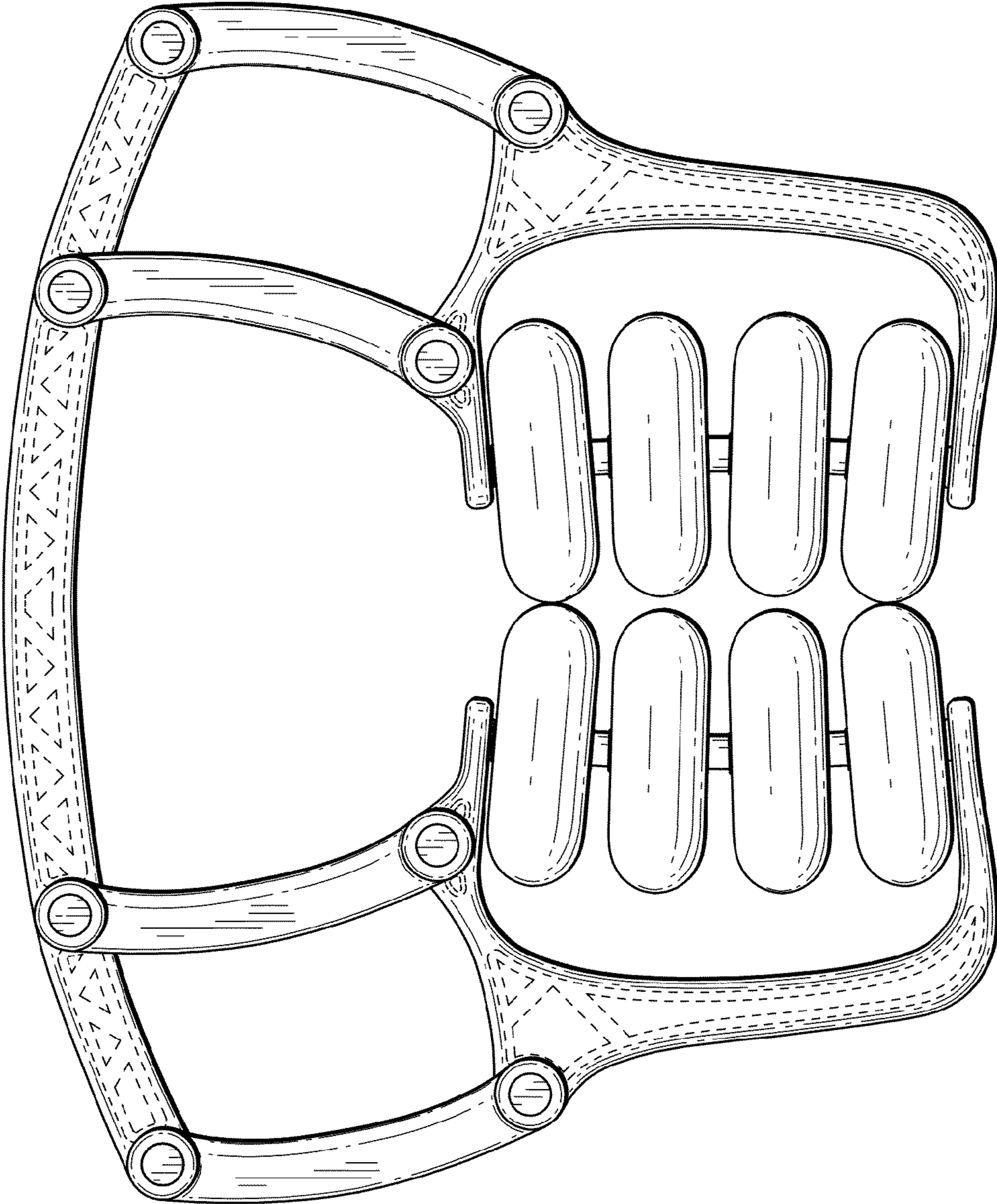

FIG. 3

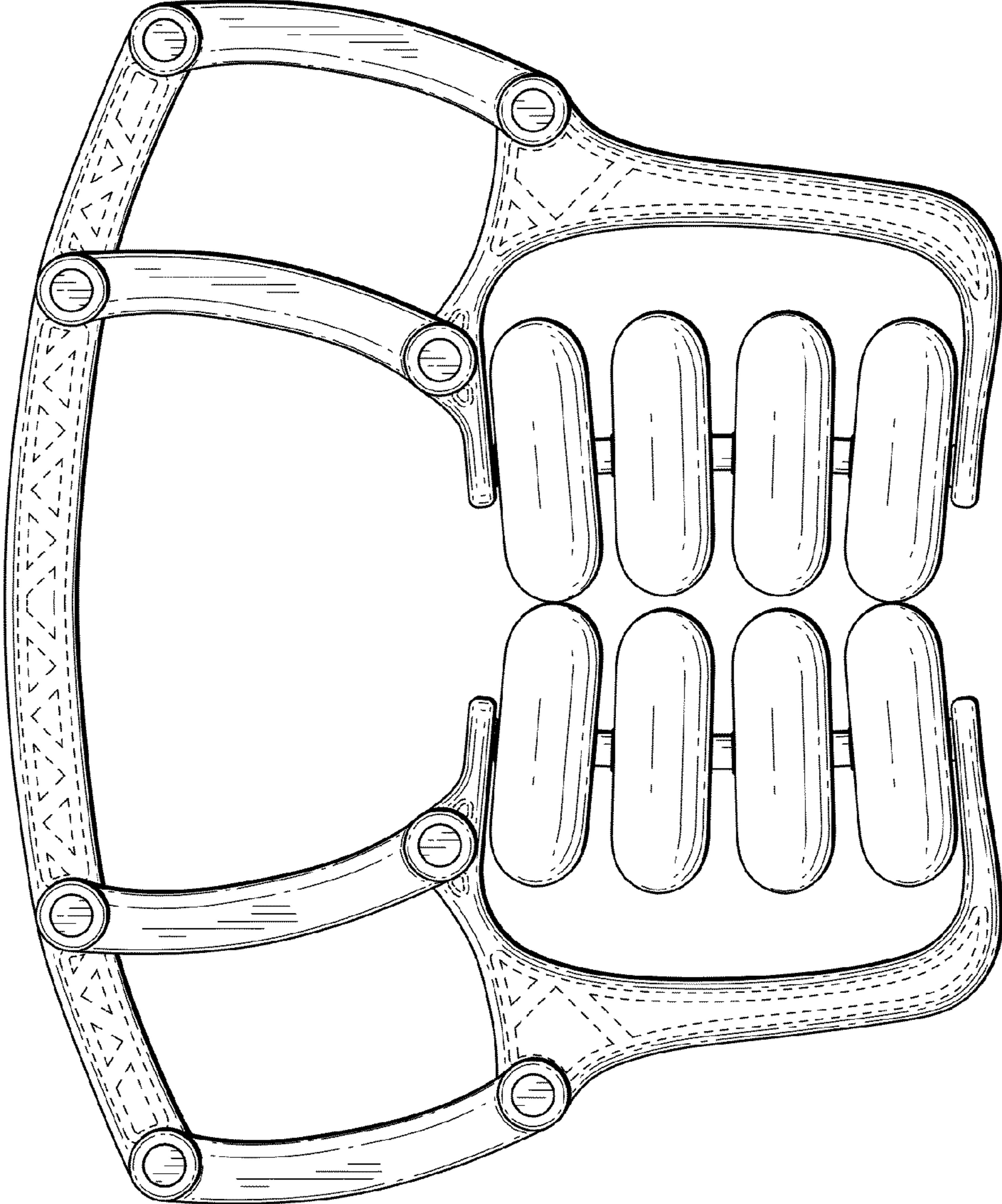

FIG. 4

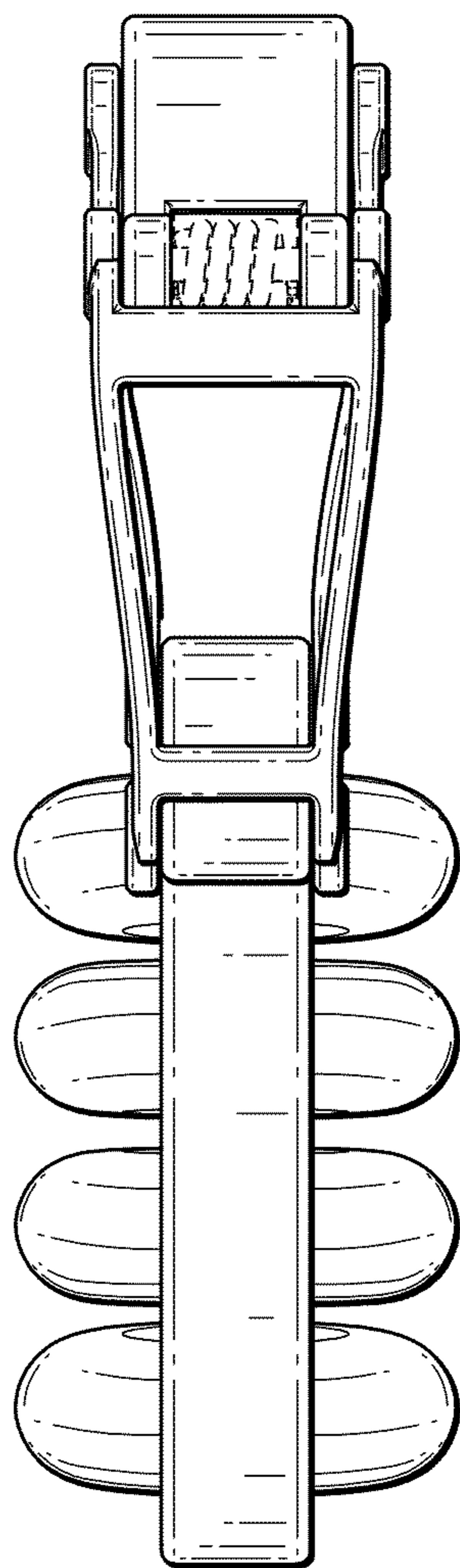

FIG. 5

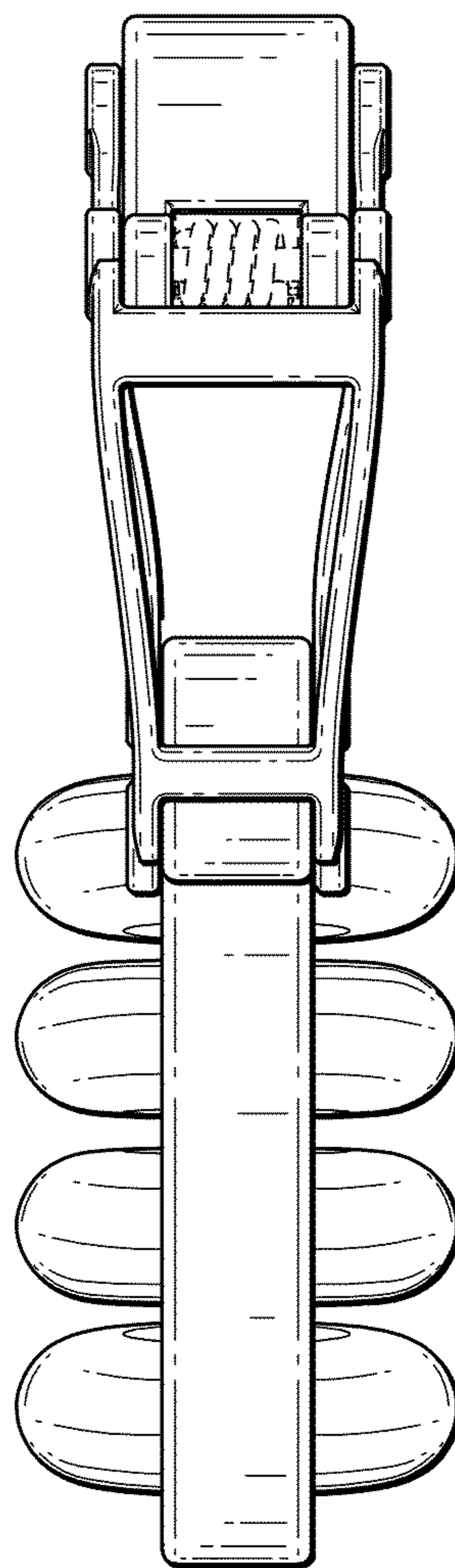

FIG. 6

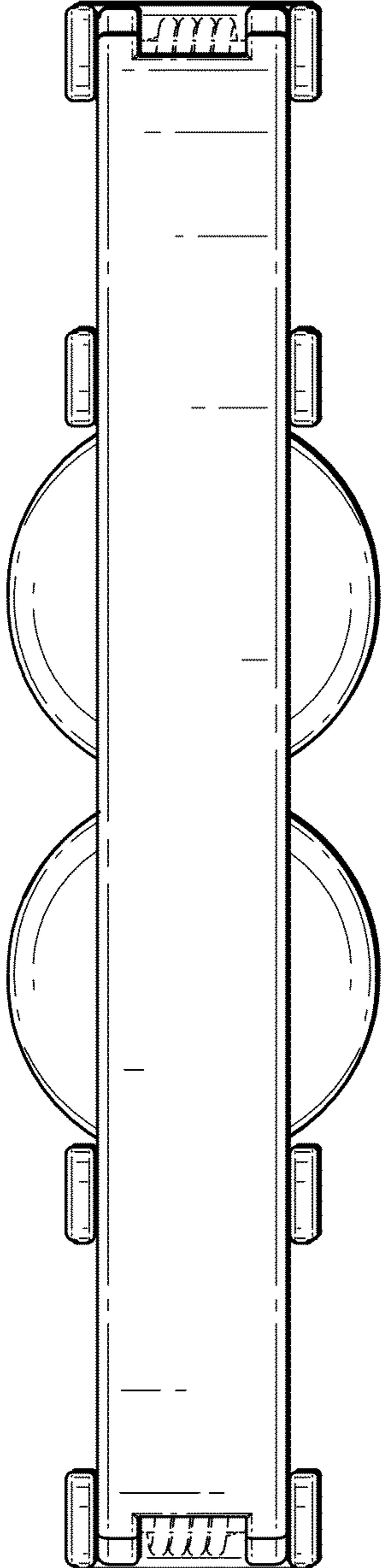

FIG. 7

