



US00D688360S

(12) **United States Design Patent**
Paz

(10) **Patent No.:** **US D688,360 S**

(45) **Date of Patent:** **** Aug. 20, 2013**

(54) **HEATER**

D594,949 S * 6/2009 Wang D23/343
D608,431 S * 1/2010 Wang D23/332
D620,569 S * 7/2010 Hall et al. D23/332

(75) **Inventor:** **Francisco Gomez Paz**, Milan (IT)

* cited by examiner

(73) **Assignee:** **Italkero S.r.l.** (IT)

Primary Examiner — T. Chase Nelson

(**) **Term:** **14 Years**

Assistant Examiner — Ania Aman

(21) **Appl. No.:** **29/418,306**

(74) *Attorney, Agent, or Firm* — Stetina Brunda Garred & Brucker

(22) **Filed:** **Apr. 13, 2012**

(57) **CLAIM**

(51) **LOC (9) Cl.** **23-03**

The ornamental design for heater, as shown and described.

(52) **U.S. Cl.**

DESCRIPTION

USPC **D23/332**; D23/314; D23/317

(58) **Field of Classification Search**

USPC D23/323, 328, 332, 336, 339, 342,
D23/386, 338, 314, 317; 126/25 R, 67, 92 A,
126/92 B, 9 A; 362/92, 217, 253; 431/331,
431/344

See application file for complete search history.

FIG. 1 is top perspective of a heater;
FIG. 2 is a front view of the heater shown in FIG. 1;
FIG. 3 is a right side view of the heater shown in FIG. 1;
FIG. 4 is a rear view of the heater shown in FIG. 1;
FIG. 5 is a left side view of the heater shown in FIG. 1;
FIG. 6 is a top view of the heater shown in FIG. 1; and,
FIG. 7 is a bottom view of the heater shown in FIG. 1.
The broken lines shown in the drawings are included for the
purpose of illustrating portions of the article that form no part
of the claimed design.

(56) **References Cited**

U.S. PATENT DOCUMENTS

D325,963 S * 5/1992 Anderson D23/342
D509,291 S * 9/2005 Cunningham et al. D23/336

1 Claim, 4 Drawing Sheets

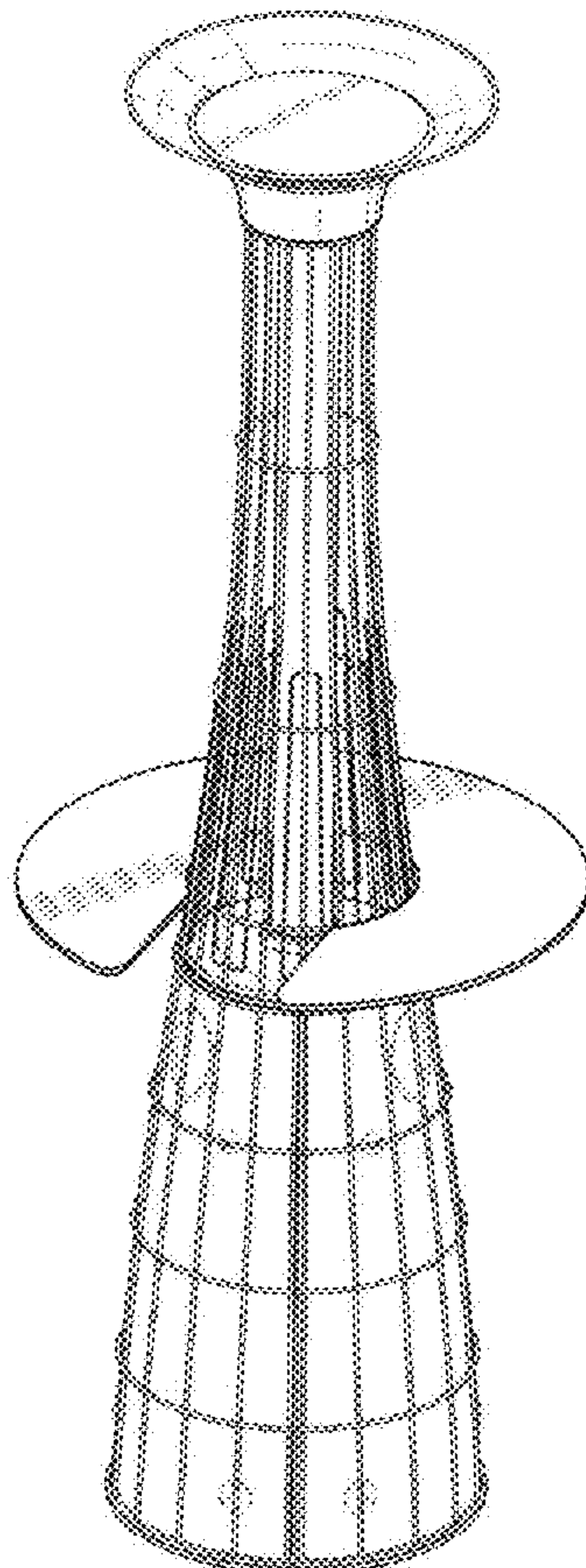

FIG. 1

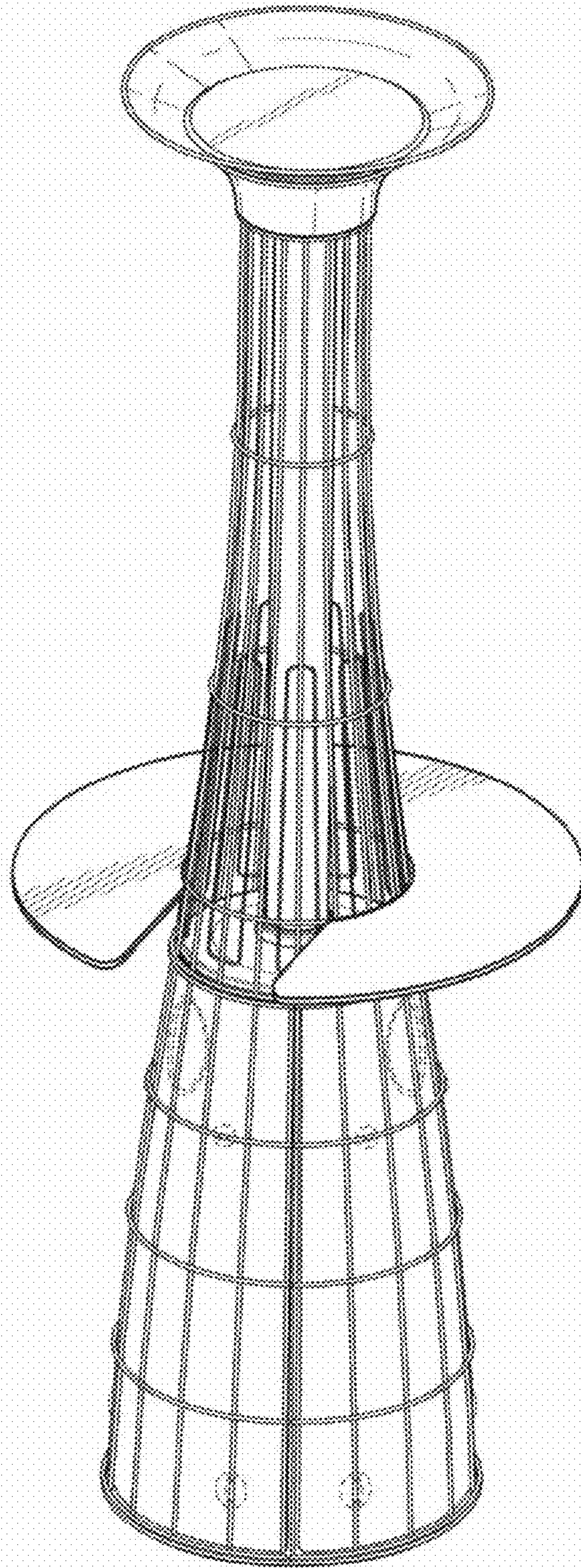

FIG. 2

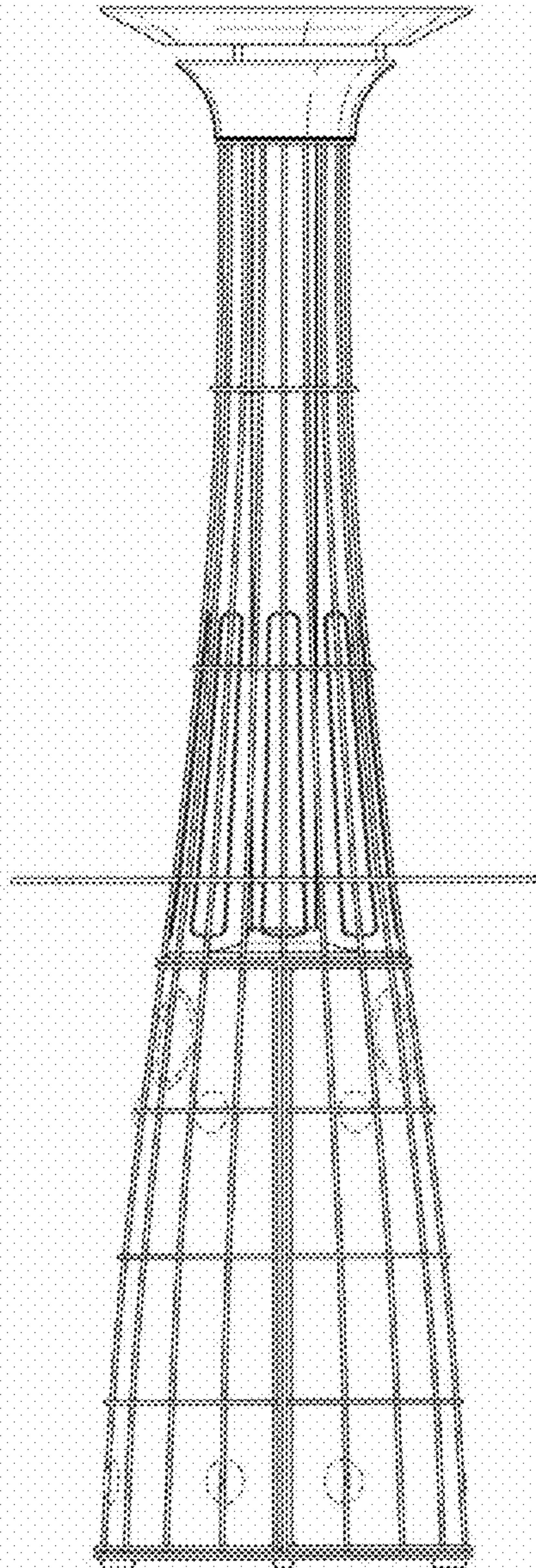

FIG. 3

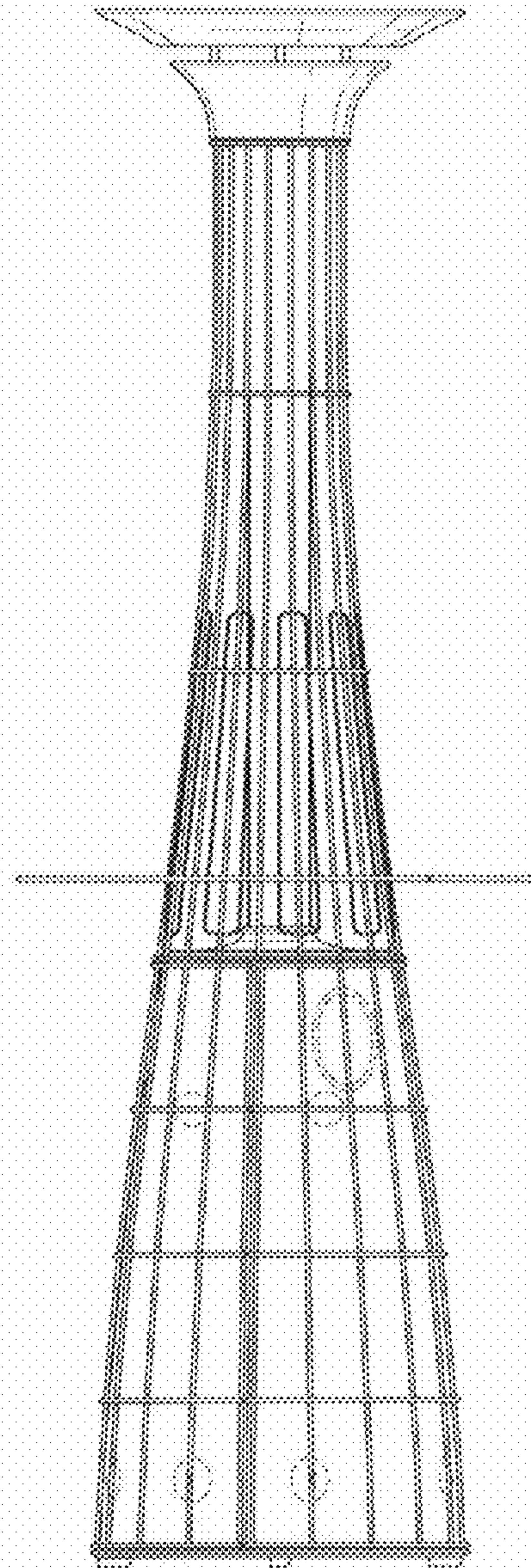

FIG. 4

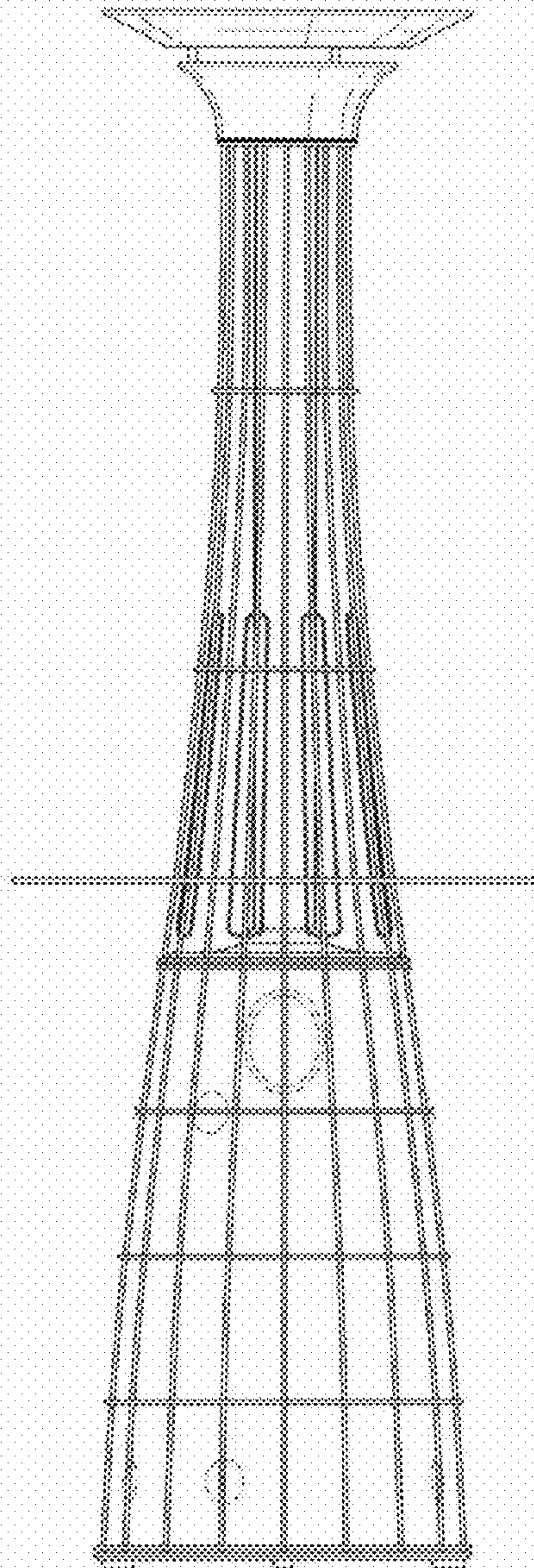

FIG. 5

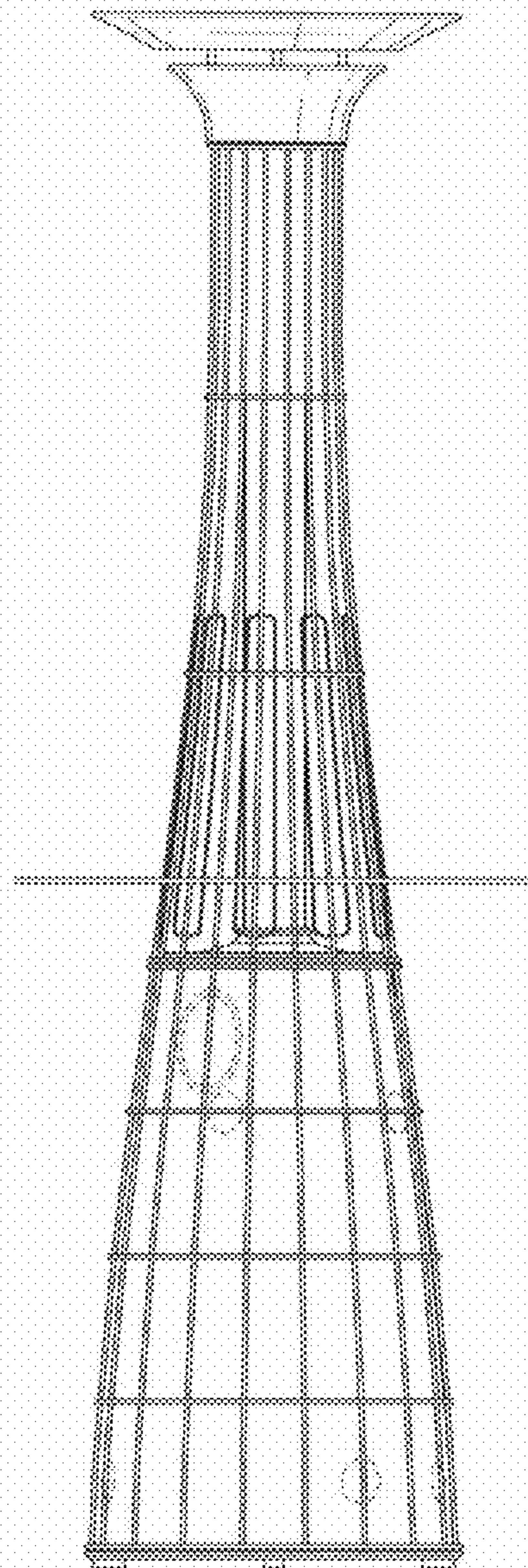

FIG. 6

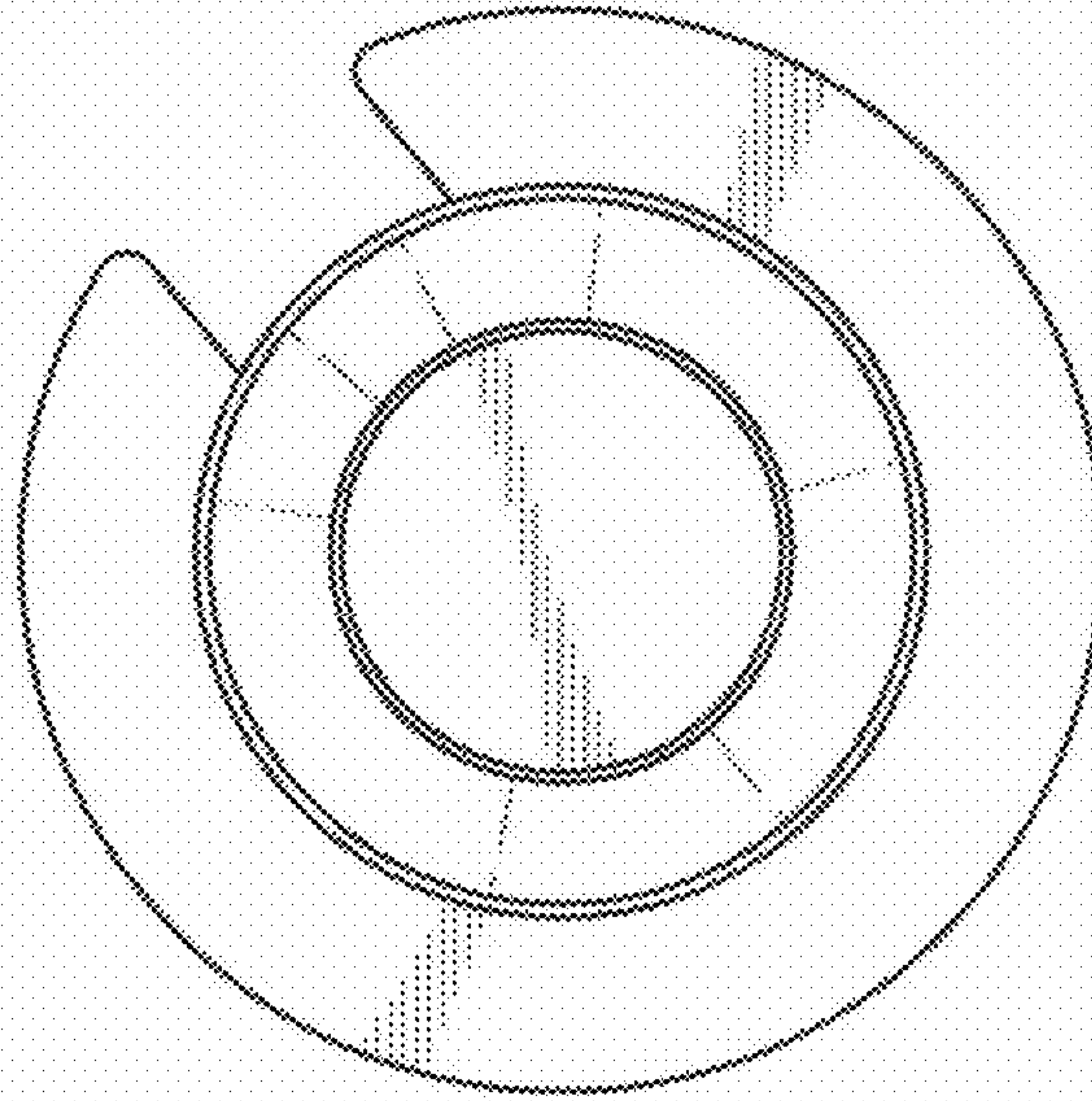

FIG. 7

