



US00D688340S

(12) **United States Design Patent**
Tang et al.

(10) **Patent No.:** **US D688,340 S**

(45) **Date of Patent:** **** Aug. 20, 2013**

(54) **PUTTER HEAD**

(75) Inventors: **Larry G. Tang**, Carlsbad, CA (US);
Augustin W. Rollinson, Carlsbad, CA
(US)

(73) Assignee: **Callaway Golf Company**, Carlsbad, CA
(US)

(**) Term: **14 Years**

(21) Appl. No.: **29/430,151**

(22) Filed: **Aug. 22, 2012**

(51) **LOC (9) Cl.** **21-02**

(52) **U.S. Cl.**
USPC **D21/742**

(58) **Field of Classification Search**
USPC D21/735-746, 759; 473/324-331,
473/340-341, 251-256
See application file for complete search history.

(56) **References Cited**

U.S. PATENT DOCUMENTS

D458,656 S *	6/2002	Tang et al.	D21/738
6,506,125 B2 *	1/2003	Helmstetter et al.	473/340
D470,904 S *	2/2003	Tang et al.	D21/742
D479,291 S *	9/2003	Murray	D21/742
D485,323 S *	1/2004	Wagner et al.	D21/744

D499,777 S *	12/2004	Yamamoto	D21/742
D572,780 S *	7/2008	Rollinson	D21/744
D592,717 S *	5/2009	Rollinson	D21/742
D619,665 S *	7/2010	Rollinson et al.	D21/742
D630,690 S *	1/2011	Rollinson	D21/746
D641,815 S *	7/2011	Rollinson et al.	D21/744
D641,816 S *	7/2011	Rollinson et al.	D21/744
D650,459 S *	12/2011	Rollinson	D21/746

* cited by examiner

Primary Examiner — Mitchell Siegel

(74) *Attorney, Agent, or Firm* — Rebecca Hanovice;
Michael A. Catania; Sonia Lari

(57) **CLAIM**

The ornamental design for a putter head, as shown and described.

DESCRIPTION

FIG. 1 is a rear perspective view of a putter head as claimed herein;

FIG. 2 is a rear view thereof;

FIG. 3 is a front view thereof;

FIG. 4 is a left side view thereof;

FIG. 5 is a right side view thereof;

FIG. 6 is a top plan view thereof; and,

FIG. 7 is a bottom plan view thereof.

The broken lines are included for the purpose of illustration form no part of the claimed design.

1 Claim, 4 Drawing Sheets

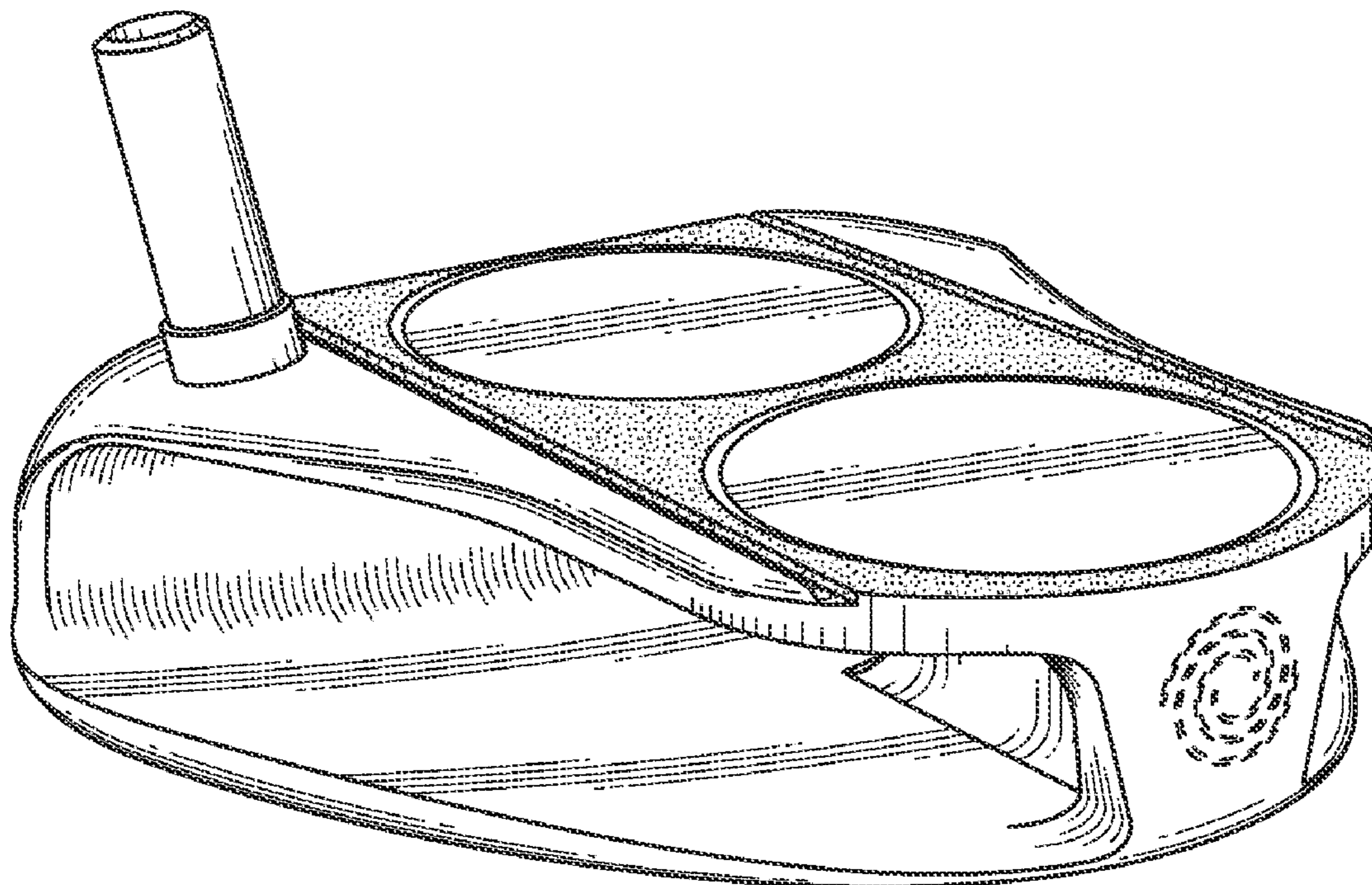

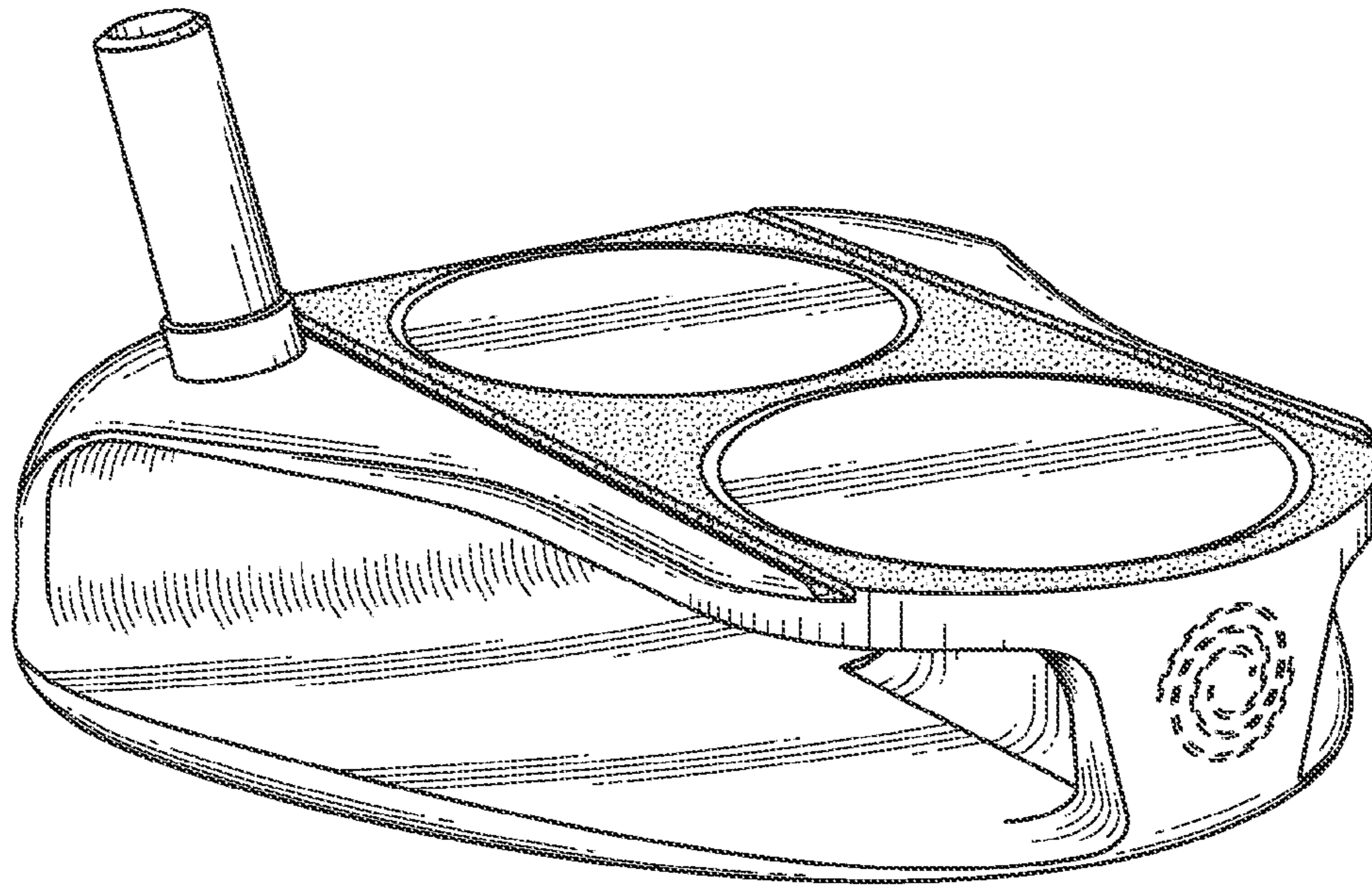

FIG. 1

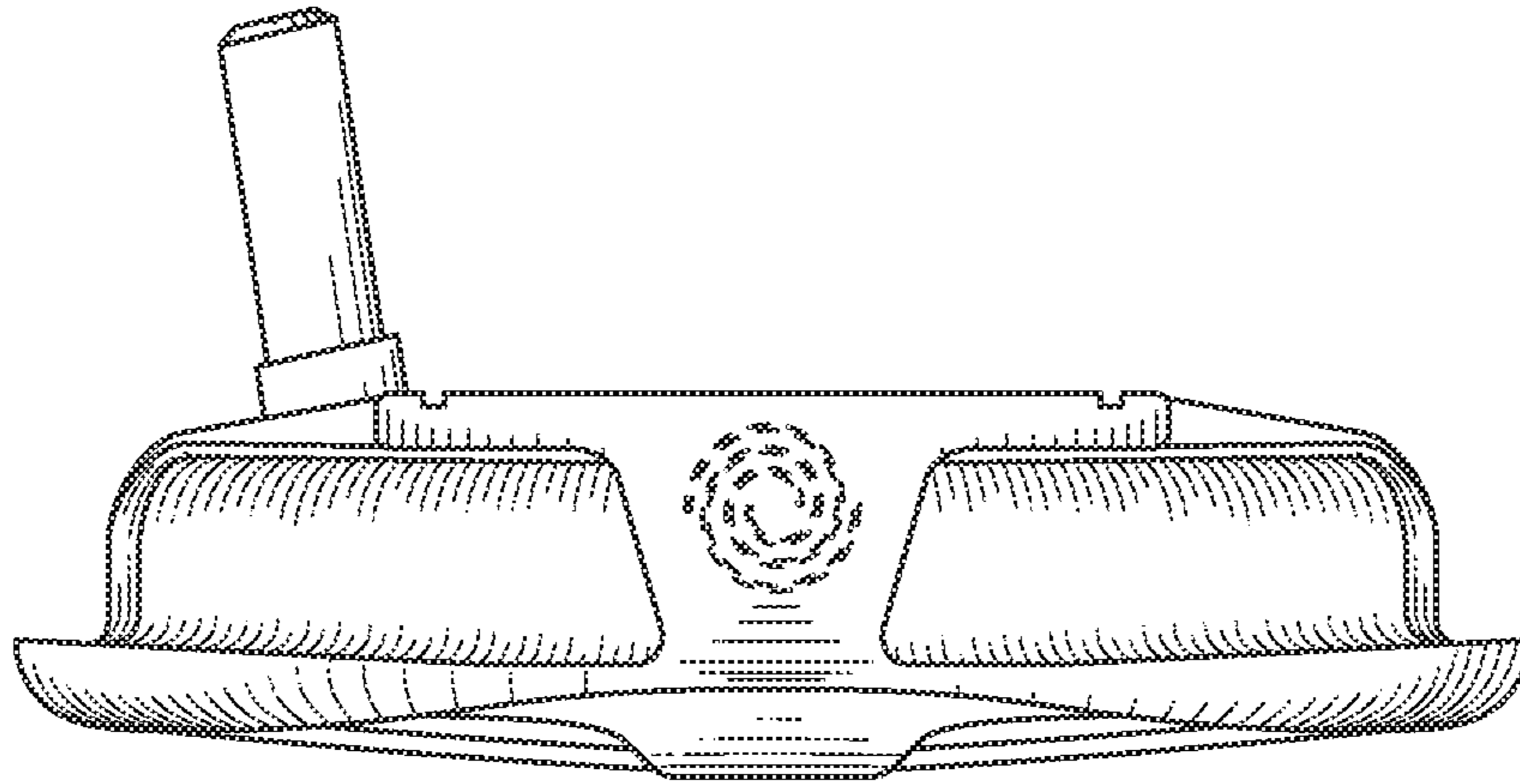

FIG. 2

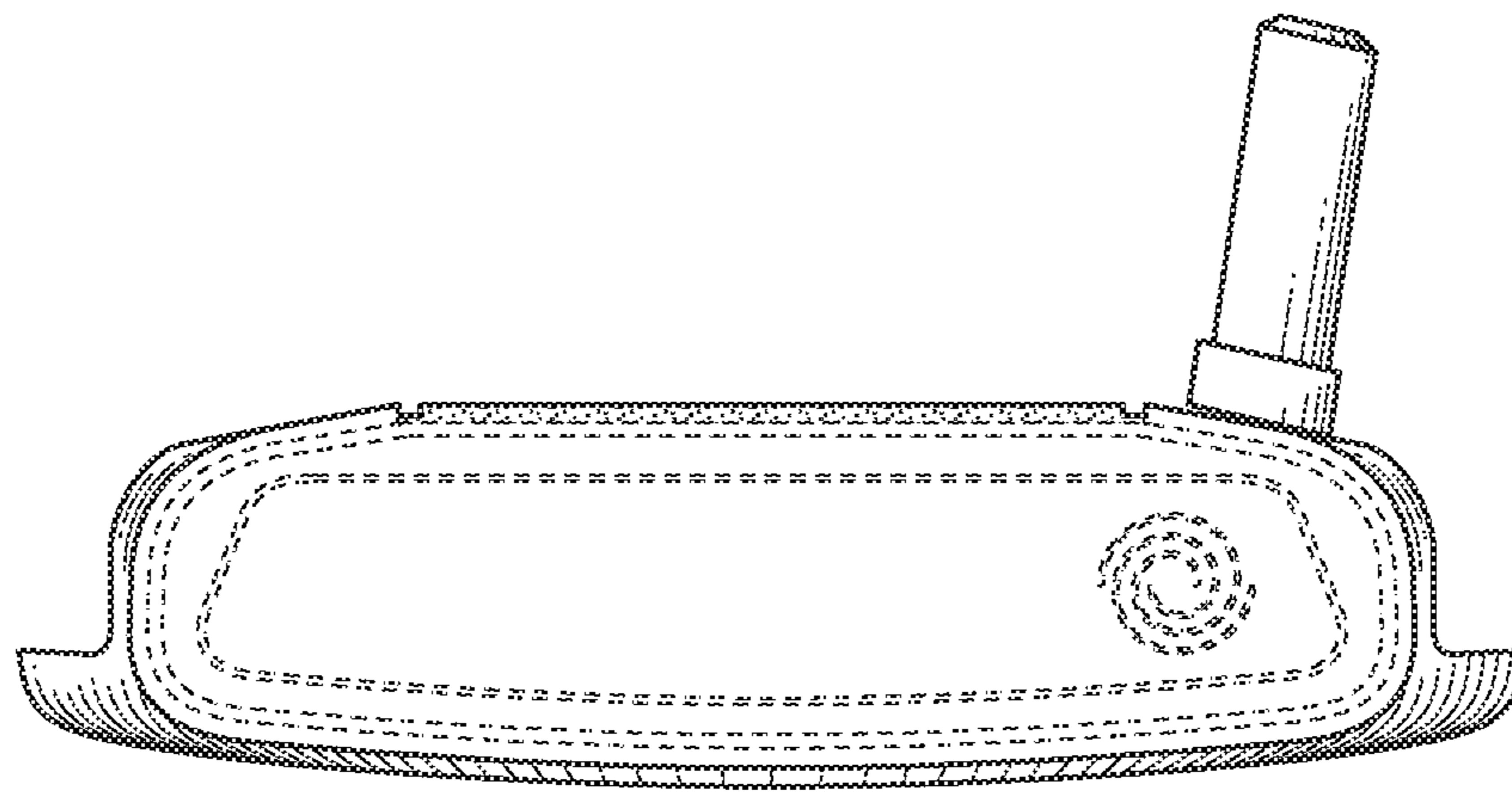

FIG. 3

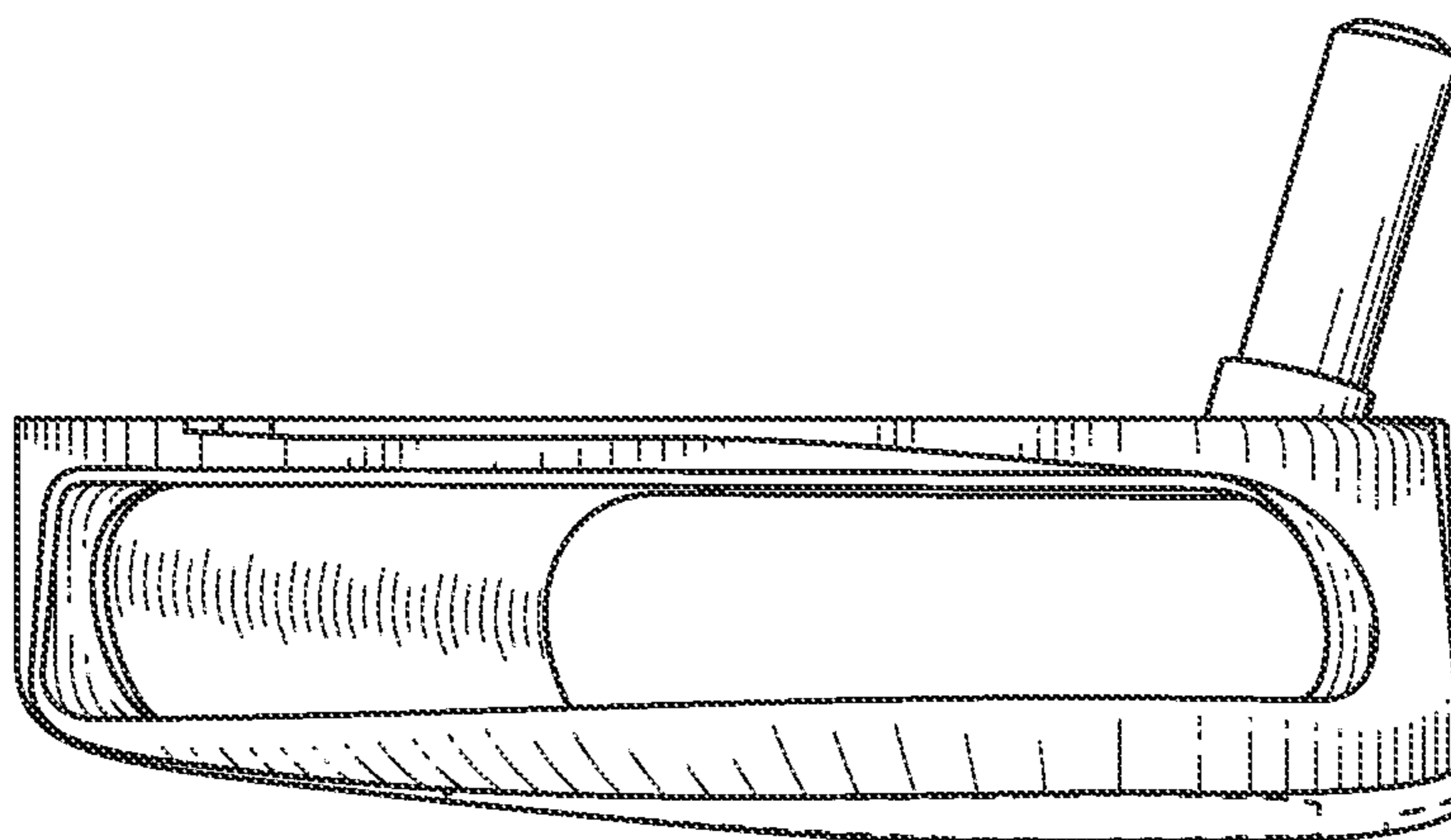

FIG. 4

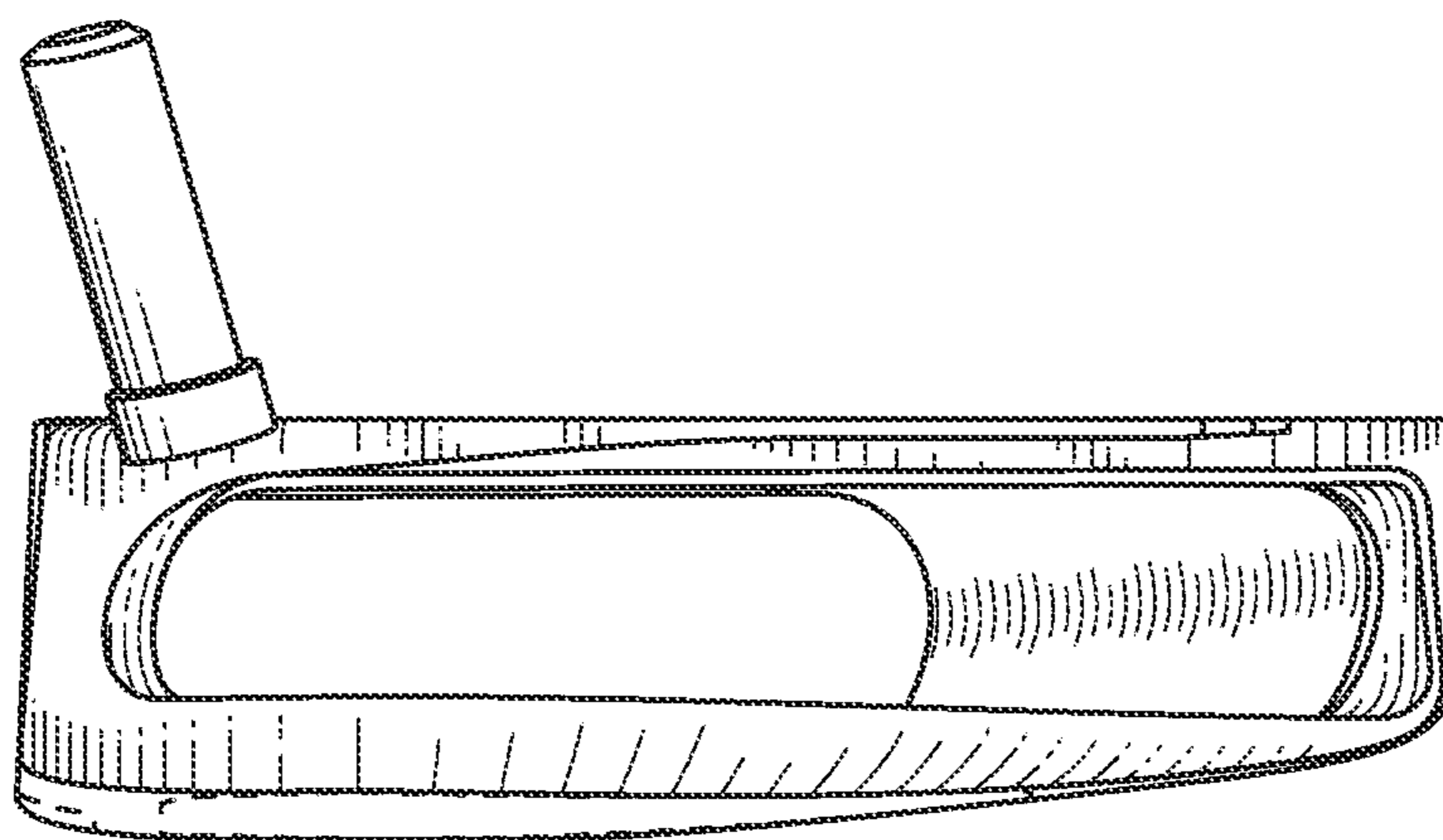

FIG. 5

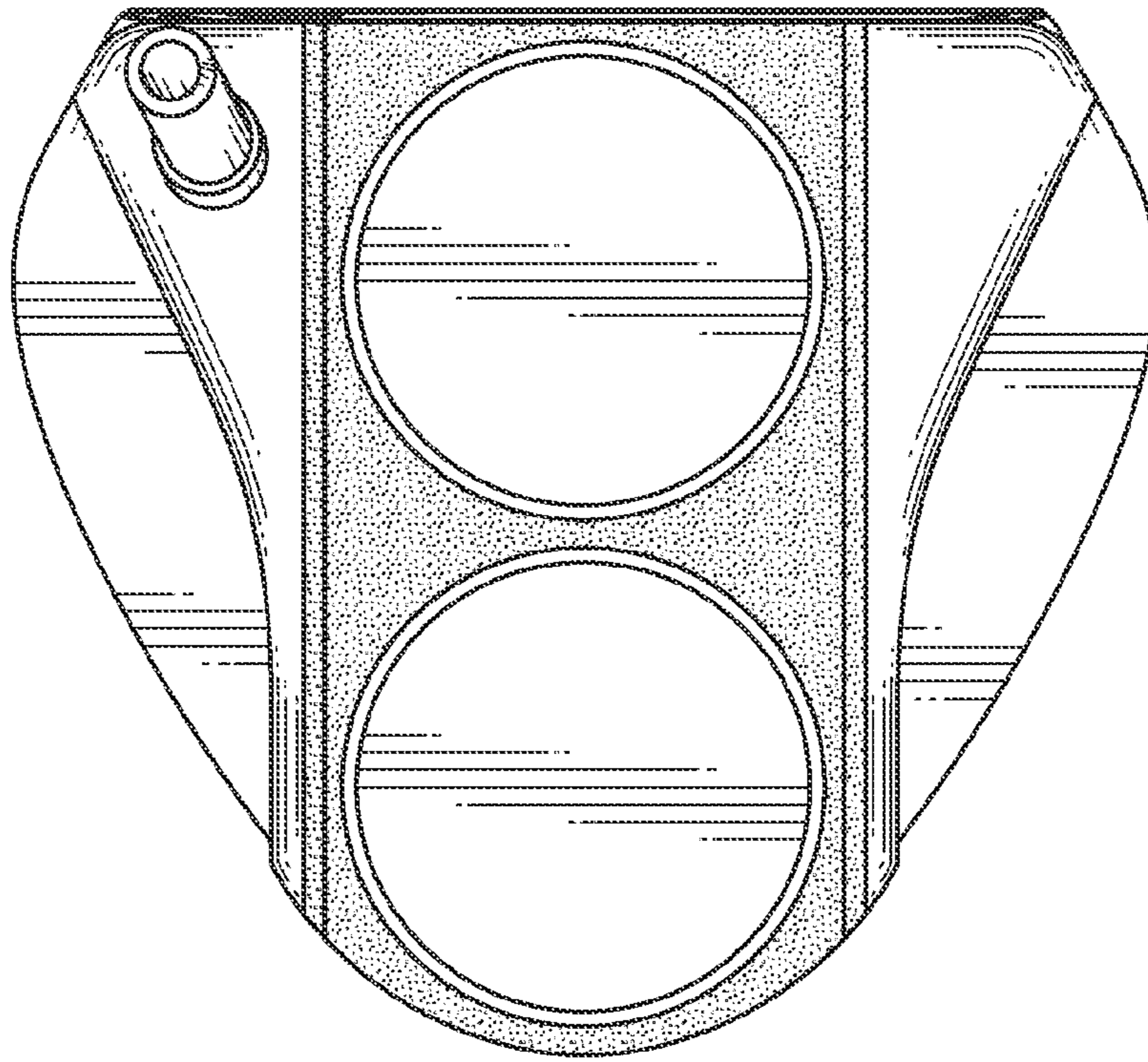

FIG. 6

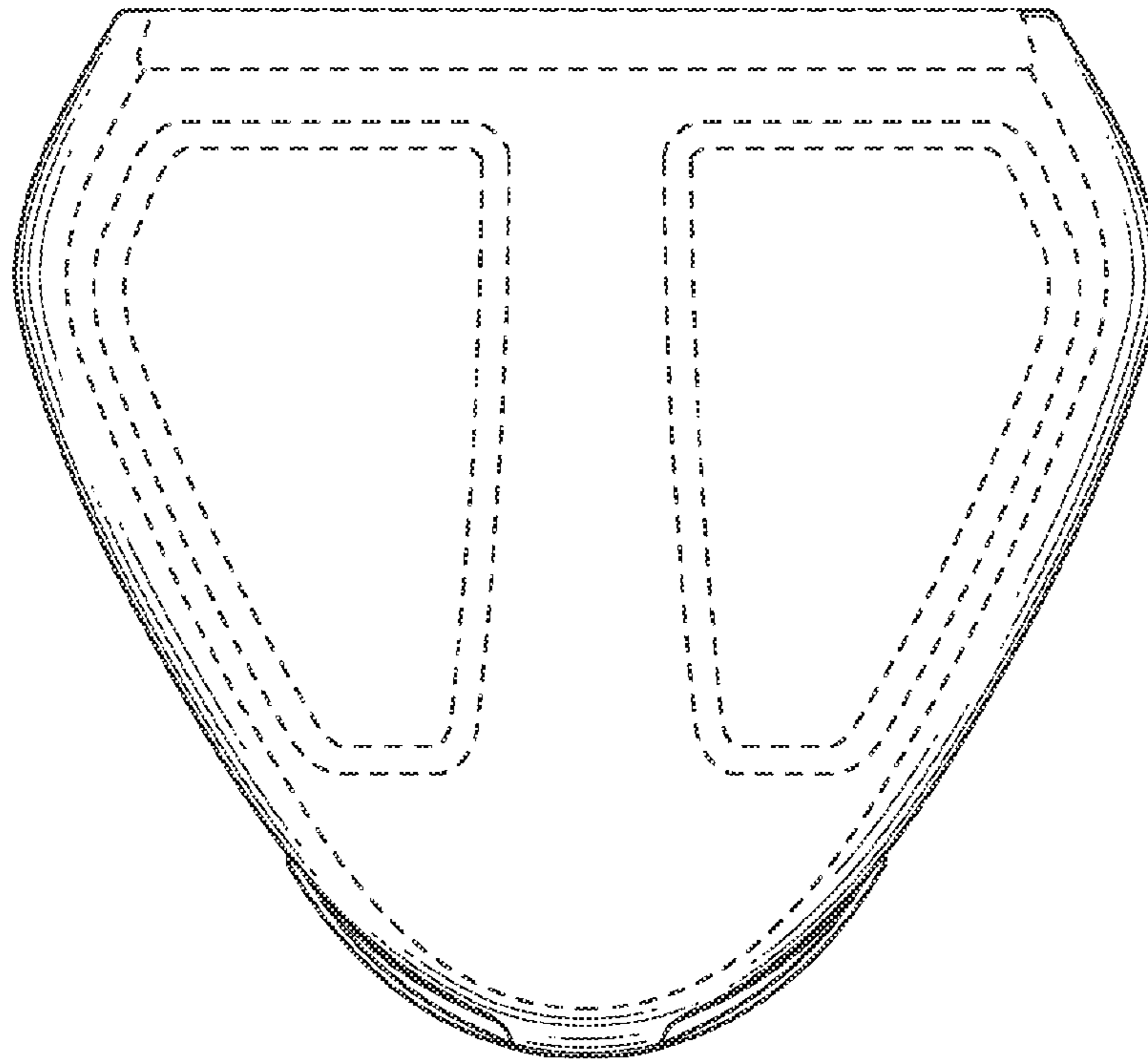

FIG. 7