



US00D688275S

(12) **United States Design Patent**
Schmelzer et al.

(10) **Patent No.:** **US D688,275 S**
(45) **Date of Patent:** **** Aug. 20, 2013**

(54) **FUEL DISPENSER**

(75) Inventors: **Anthony E. Schmelzer**, Austin, TX (US); **Daniel C. Harrell**, Georgetown, TX (US); **Daniel Deruntz**, Somerville, MA (US); **Kent W. Robinson**, Quakertown, PA (US); **Eva-Lie Edvardsson**, Solvesborg (SE); **Gian Pangaro**, St. Somerville, MA (US); **Jason Robinson**, Tewksbury, MA (US); **Kevin Burnett**, Round Rock, TX (US); **Russell Haecker**, Round Rock, TX (US); **Timothy Raymond Proulx**, Nashua, NH (US)

4,576,312 A *	3/1986	Swick, Jr.	222/27
D309,144 S *	7/1990	Austin et al.	D15/9.2
D415,168 S *	10/1999	Wilson et al.	D15/9.2
D415,501 S *	10/1999	Wilson et al.	D15/9.2
D420,684 S *	2/2000	Wilson et al.	D15/9.2
D421,612 S *	3/2000	Wilson et al.	D15/9.2
D422,285 S *	4/2000	Wilson et al.	D15/9.2
D422,604 S *	4/2000	Wilson et al.	D15/9.2
D440,579 S *	4/2001	Wilson et al.	D15/9.2
D454,421 S	3/2002	Jeon et al.	
D481,516 S	10/2003	Magee et al.	
D481,517 S	10/2003	Magee et al.	
D481,518 S	10/2003	Magee et al.	

(Continued)

OTHER PUBLICATIONS

“Tokheim Crypto VGA” [online], published at least as early as Oct. 16, 2009, Retrieved from the Internet URL: <http://www.tokheim.com/main/index1.php?url=25&lg>.

(Continued)

Primary Examiner — Ralf Seifert

(74) *Attorney, Agent, or Firm* — Hiscock & Barclay LLP

(73) Assignee: **Dresser Wayne AB**, Malmo (SE)

(**) Term: **14 Years**

(21) Appl. No.: **29/388,861**

(22) Filed: **Apr. 4, 2011**

(30) **Foreign Application Priority Data**

Oct. 4, 2010 (EM) 001238117-0005

(51) **LOC (9) Cl.** **15-02**

(52) **U.S. Cl.**
USPC **D15/9.2**

(58) **Field of Classification Search**
USPC D15/7-9; D23/231, 232, 225; 417/60, 417/235, 265, 321, 355, 358, 363, 359, 410.1, 417/415-416, 405, 900, 43, 554; 60/408, 60/412; 184/26-37; 415/140-147; 123/495, 123/509; 166/105.1, 105.2, 311
See application file for complete search history.

(56) **References Cited**

U.S. PATENT DOCUMENTS

D262,971 S *	2/1982	Robinson et al.	D15/9.2
D281,427 S *	11/1985	Baffo et al.	D15/9.2

(57) **CLAIM**

The ornamental design for a fuel dispenser, substantially as shown and described.

DESCRIPTION

FIG. 1 is a front, right side perspective view of a fuel dispenser showing our design;
FIG. 2 is a front view thereof;
FIG. 3 is a rear view thereof;
FIG. 4 is a right side view thereof;
FIG. 5 is a left side view thereof;
FIG. 6 is a top view thereof; and,
FIG. 7 is a bottom view thereof.
Portions of a fuel dispenser shown in broken lines form no part of the claimed design.

1 Claim, 6 Drawing Sheets

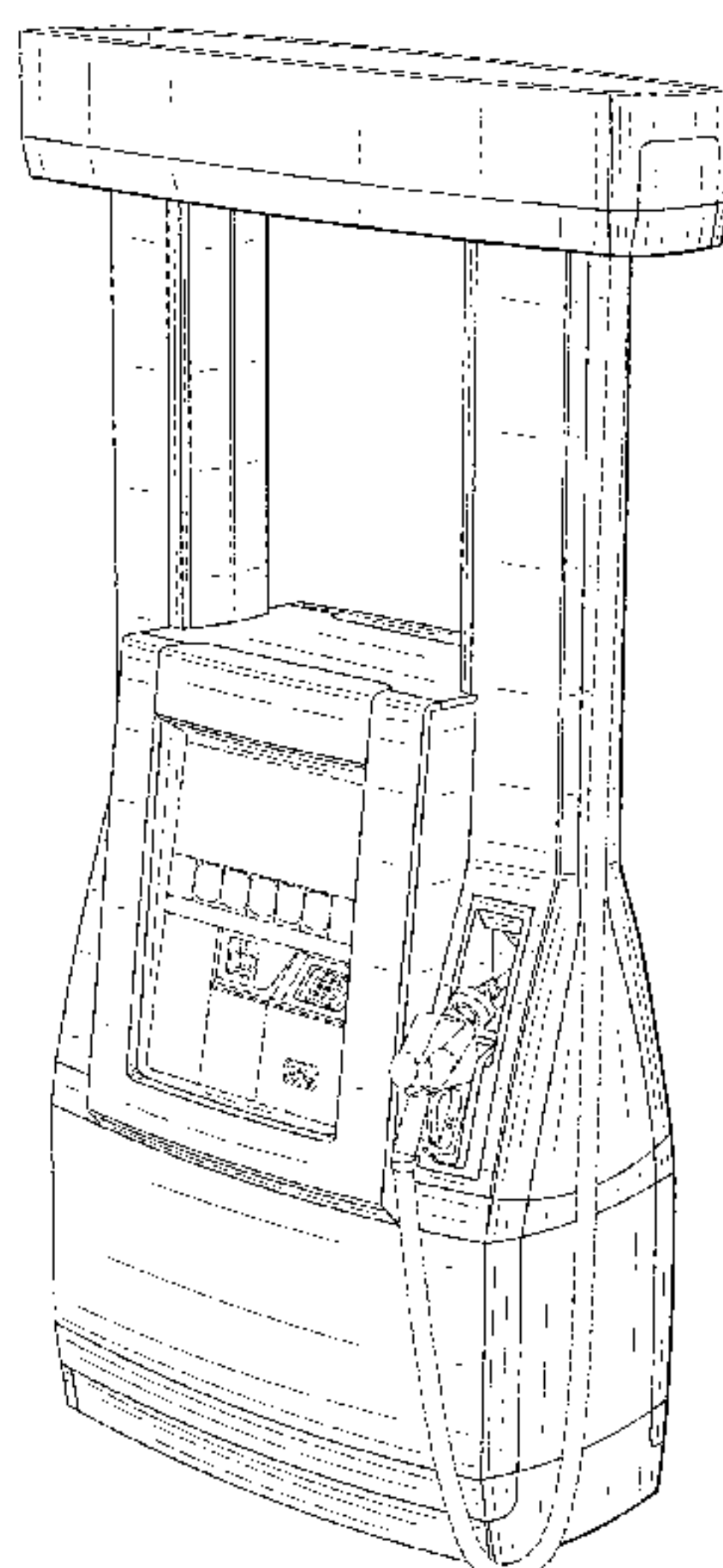

(56)

References Cited

U.S. PATENT DOCUMENTS

D485,417	S	1/2004	Magee et al.	
D487,834	S	3/2004	Zerman et al.	
D488,280	S	4/2004	Zerman et al.	
D492,081	S	6/2004	Magee et al.	
D500,905	S	1/2005	Magee et al.	
D602,225	S	10/2009	Lute et al.	
D623,375	S	9/2010	Douglass et al.	
D625,305	S	10/2010	Bleck et al.	
D628,764	S	12/2010	Bleck et al.	
D629,585	S	12/2010	Bleck et al.	
D631,634	S	1/2011	Bleck et al.	
D667,846	S *	9/2012	Helgesson et al.	D15/9.2
2010/0161489	A1	6/2010	Goodall et al.	
2010/0176191	A1	7/2010	Ramachandran et al.	
2010/0187299	A1	7/2010	Block et al.	
2010/0187300	A1	7/2010	Ramachandran et al.	
2010/0241564	A1	9/2010	Miller et al.	
2010/0243729	A1	9/2010	Russell et al.	
2010/0258621	A1	10/2010	Schlabach et al.	

OTHER PUBLICATIONS

“Petrotec Genesys OPT” [online], published at least as early as Oct. 16, 2009, Retrieved from the Internet URL: <http://www.petrotec.pt/index.php?id=74&tbl=registos&id2=201>.

“Hectronic Hecstar” [online], published at least as early as Oct. 16, 2009, Retrieved from the Internet URL: <http://www.hectronic.com/en/products/refuelling/autofuel-systems/hecstar/>.

“Hectronic Hecfleet” [online], published at least as early as Oct. 16, 2009, Retrieved from the Internet URL: <http://www.hectronic.com/en/products/refuelling/autofuel-systems/hecfleet/>.

“Gilbarco Autotank FlexPay NP3” [online], published at least as early as Oct. 16, 2009, Retrieved from the Internet URL: http://www.autotank.com/product_29.aspx.

“Gilbarco Autotank FlexPay SK3” [online], published at least as early as Oct. 16, 2009, Retrieved from the Internet URL: http://www.autotank.com/product_30.aspx.

“Gilbarco Autotank FlexPay B2B” [online], published at least as early as Oct. 16, 2009, Retrieved from the Internet URL: http://www.autotank.com/product_28.aspx.

“Hectronic the different way. In the thick of it. And refreshingly different.” [online], published at least as early as Oct. 16, 2009, Retrieved from the Internet URL: http://www.hectronic.com/en/nc/documentation/company/?tx_drblob_pil%5BdownloadUid%5D=6.

“Tokheim Quantum 500T” [online], published at least as early as Apr. 13, 2010, [Retrieved on Jul. 27, 2010]; Retrieved from the Internet URL: <http://www.tokheim.com/main/index1.php?url=130&lg=>.

“Tokheim Quantum 400T” [online], published at least as early as Apr. 13, 2010, [Retrieved on Jul. 27, 2010]; Retrieved from the Internet URL: <http://www.tokheim.com/main/index1.php?url=131&lg=>.

“Tokheim Quantum 300T” [online], published at least as early as Apr. 13, 2010, [Retrieved on Jul. 27, 2010]; Retrieved from the Internet URL: <http://www.tokheim.com/main/index1.php?url=132&lg=>.

“Tokheim Quantum 200T” [online], published at least as early as Apr. 13, 2010, [Retrieved on Jul. 27, 2010]; Retrieved from the Internet URL: <http://www.tokheim.com/main/index1.php?url=133&lg=>.

“Tokheim Quantum 100T” [online], published at least as early as Apr. 13, 2010, [Retrieved on Jul. 27, 2010]; Retrieved from the Internet URL: <http://www.tokheim.com/main/index1.php?url=134&lg=>.

“Bennett Pacific Series Retail Multi-Product Dispensers” [online], published at least as early as Apr. 13, 2010, [Retrieved on Jul. 27, 2010]; Retrieved from the Internet URL: <http://www.bennettpump.com/products/pacific-series>.

“Bennett BlueFueler Series Diesel Exhaust Fluid Dispensers” [online], published at least as early as Apr. 13, 2010, [Retrieved on Jul. 27, 2010]; Retrieved from the Internet URL: <http://www.bennettpump.com/products/def>.

Bennett Big Squirt High Speed Truck Stop Fueling: [online], published at least as early as Apr. 13, 2010, [Retrieved on Jul. 27, 2010]; Retrieved from the Internet URL: <http://www.bennettpump.com/products/big-squirt>.

“Bennett Horizon2 Series Retail Multi-Product Dispensers/Pumps”: [online], published at least as early as Apr. 13, 2010, [Retrieved on Jul. 28, 2010]; Retrieved from the Internet URL: <http://www.bennettpump.com/products/horizon2-series>.

“Bennett Special Retail Applications 3000 Series Retail Single and Dual Dispensers/Pumps”: [online], published at least as early as Apr. 13, 2010, [Retrieved on Jul. 28, 2010]; Retrieved from the Internet URL: <http://www.bennettpump.com/products/special-retail-applications>.

“Bennett Commercial Industrial Fleet Fueling”: [online], published at least as early as Apr. 13, 2010, [Retrieved on Jul. 28, 2010]; Retrieved from the Internet URL: <http://www.bennettpump.com/products/commercial-industrial-fleet-fueling>.

Dresser Wayne, *Harmony Series Dispensers Parts Manual*, Part No. 920640 Rev A, Mar. 2002, cover page.

“Dresser Wayne Ovation LX”: [online], published at least as early as Apr. 13, 2010, [Retrieved on Jul. 28, 2010]; Retrieved from the Internet URL: <http://www.wayne.com/index.cfm/go/product-detail/product/Ovation-LX/>.

“Dresser Wayne Ovation”: [online], published at least as early as Apr. 13, 2010, [Retrieved on Jul. 28, 2010]; Retrieved from the Internet URL: <http://www.wayne.com/index.cfm/go/product-detail/product/ovation/>.

“Dresser Wayne Global Ovation iX”: [online], published at least as early as Apr. 13, 2010, [Retrieved on Jul. 28, 2010]; Retrieved from the Internet URL: <http://www.wayne.com/index.cfm/go/product-detail/product/global-ovation-ix/>.

“Dresser Wayne Global Star V”: [online], published at least as early as Apr. 13, 2010, [Retrieved on Jul. 28, 2010]; Retrieved from the Internet URL: <http://www.wayne.com/index.cfm/go/product-detail/product/global-star/>.

“Dresser Wayne Global Star LPG”: [online], published at least as early as Apr. 13, 2010, [Retrieved on Jul. 28, 2010]; Retrieved from the Internet URL: <http://www.wayne.com/index.cfm/go/product-detail/product/global-star-lpg/>.

“Dresser Wayne Vista”: [online], published at least as early as Apr. 13, 2010, [Retrieved on Jul. 28, 2010]; Retrieved from the Internet URL: <http://www.wayne.com/index.cfm/go/product-detail/product/Vista/>.

“Dresser Wayne HS Vista”: [online], published at least as early as Apr. 13, 2010, [Retrieved on Aug. 4, 2010]; Retrieved from the Internet URL: <http://www.wayne.com/index.cfm/go/product-detail/product/hs-vista/>.

“Dresser Wayne Global Vista”: [online], published at least as early as Apr. 13, 2010, [Retrieved on Sep. 1, 2010]; Retrieved from the Internet URL: <http://www.wayne.com/index.cfm/go/product-detail/product/global-vista/>.

“Dresser Wayne Century”: [online], published at least as early as Apr. 13, 2010, [Retrieved on Sep. 1, 2010]; Retrieved from the Internet URL: [http://www.wayne.com/index.cfm/go/product-detail/product/century-\(na\)/](http://www.wayne.com/index.cfm/go/product-detail/product/century-(na)/).

“Dresser Wayne Global Century”: [online], published at least as early as Apr. 13, 2010, [Retrieved on Sep. 1, 2010]; Retrieved from the Internet URL: <http://www.wayne.com/index.cfm/go/product-detail/product/Global%20Century%20Fuel%20Dispenser/>.

“Dresser Wayne Century G1000”: [online], published at least as early as Apr. 13, 2010, [Retrieved on Sep. 1, 2010]; Retrieved from the Internet URL: <http://www.wayne.com/index.cfm/go/product-detail/product/century-g1000/>.

“Dresser Wayne Vista—China Edition”: [online], published at least as early as Apr. 13, 2010, [Retrieved on Sep. 1, 2010]; Retrieved from the Internet URL: <http://www.wayne.com/index.cfm/go/product-detail/product/china%20vista/>.

“Dresser Wayne Century—China Edition”: [online], published at least as early as Apr. 13, 2010, [Retrieved on Sep. 1, 2010]; Retrieved

from the Internet URL: <http://www.wayne.com/index.cfm/go/product-detail/product/china%20century/>.

“Dresser Wayne DEF Dispenser”: [online], published at least as early as Apr. 13, 2010, [Retrieved on Sep. 1, 2010]; Retrieved from the Internet URL: <http://www.wayne.com/index.cfm/go/product-detail/product/DEF-Dispenser/>.

“Gilbarco Encore S”: [online], published at least as early as Apr. 13, 2010, [Retrieved on Sep. 1, 2010]; Retrieved from the Internet URL: <http://www.gilbarco.com/page/EncoreS>.

“Gilbarco Encore 300”: [online], published at least as early as Apr. 13, 2010, [Retrieved on Sep. 1, 2010]; Retrieved from the Internet URL: http://www.gilbarco.com/object/encore_300_dispensers.html.

“Gilbarco Encore Ultra-Hi Flow”: [online], published at least as early as Apr. 13, 2010, [Retrieved on Sep. 1, 2010]; Retrieved from the Internet URL: http://www.gilbarco.com/object/encore_300_Ultra-Hi_Flow.html.

“Gilbarco Performer”: [online], published at least as early as Apr. 13, 2010, [Retrieved on Sep. 1, 2010]; Retrieved from the Internet URL: <http://www.gilbarco.com/page/Performer>.

“Gilbarco Legacy Series—Mechanical”: [online], published at least as early as Apr. 13, 2010, [Retrieved on Sep. 1, 2010]; Retrieved from the Internet URL: http://www.gilbarco.com/object/Legacy_Series_Mechanical_context.

“Gilbarco Legacy Series—Electronic”: [online], published at least as early as Apr. 13, 2010, [Retrieved on Sep. 1, 2010]; Retrieved from the Internet URL: http://www.gilbarco.com/page/Legacy_Electronic.

“Gilbarco Encore”, publication at least as early as Apr. 13, 2010; www.mecoatlanta.com.

“Tokheim Premier C”: [online], published at least as early as Apr. 13, 2010, [Retrieved on Oct. 8, 2010]; Retrieved from the Internet URL: <http://www.graffco.com/T%20Premier%20C%20Blender.htm>.

“Gilbarco Encore 300”, publication at least as early as Apr. 2008; www.mecoatlanta.com, [Retrieved on Oct. 12, 2010]; Retrieved from the Internet URL: www.archive.org.

Dresser Wayne Pignone, *Global Star HH and LHR, Global technology for multiproduct dispensers*, Global Star HH/LHR-4 pages-480291 GB, Revision Date Jul. 6, 2004; publication date at least as early as Oct. 14, 2009.

Dresser Wayne, *Reliance™ Series Fleet Pumps & Dispensers, A Reliable Solution for Fleet Fueling*, Reliance-4 G6200 PN 920800 Rev B 4/05; publication date at least as early as Oct. 14, 2009.

Dresser Wayne, *Select Series Fleet Pumps & Dispensers, Advanced Technology for Fleet Fueling*, Select-4 G7200 PN 920801 B 4/05; publication date at least as early as Oct. 14, 2009.

Dresser Wayne Pignone, *Global Star SCR Dispenser*; Global Star for SCR-2 pages-480292 GB, Revision Date Jul. 14, 2004; publication date at least as early as Oct. 14, 2009.

Dresser Wayne, *Vista Series Pumps & Dispensers, Unmatched Flexibility in Forecourt Equipment Solutions*, Vista-4 PN 920778 Rev. B 4/05; publication date at least as early as Oct. 14, 2009.

Dresser Wayne, *3/G 3000, Global Century High Multi-Grage/Multi-Product Dispensers, Increased flexibility using less island space.*; publication date at least as early as Oct. 14, 2009.

Dresser Wayne Pignone, *DPXF CNG model dispenser, Compressed Natural Gas (CNG) dispenser*; DPX-F CNG dispenser—Code TLO 29082—Revision 0—Sep. 2004; publication date at least as early as Oct. 14, 2009.

Dresser Wayne Pignone, *DPX-A model fuel dispenser, Multiproduct type*, DPX-A fuel dispenser—Code TLO 29079—Revision 0—Sep. 2004; publication date at least as early as Oct. 14, 2009.

Dresser Wayne, *Ovation™ Series Dispensers, Leading the Industry in Technology and Evolutionary Design*, Ovation-4 PN 920777 Rev B 4/05; publication date at least as early as Oct. 14, 2009.

* cited by examiner

FIG. 1

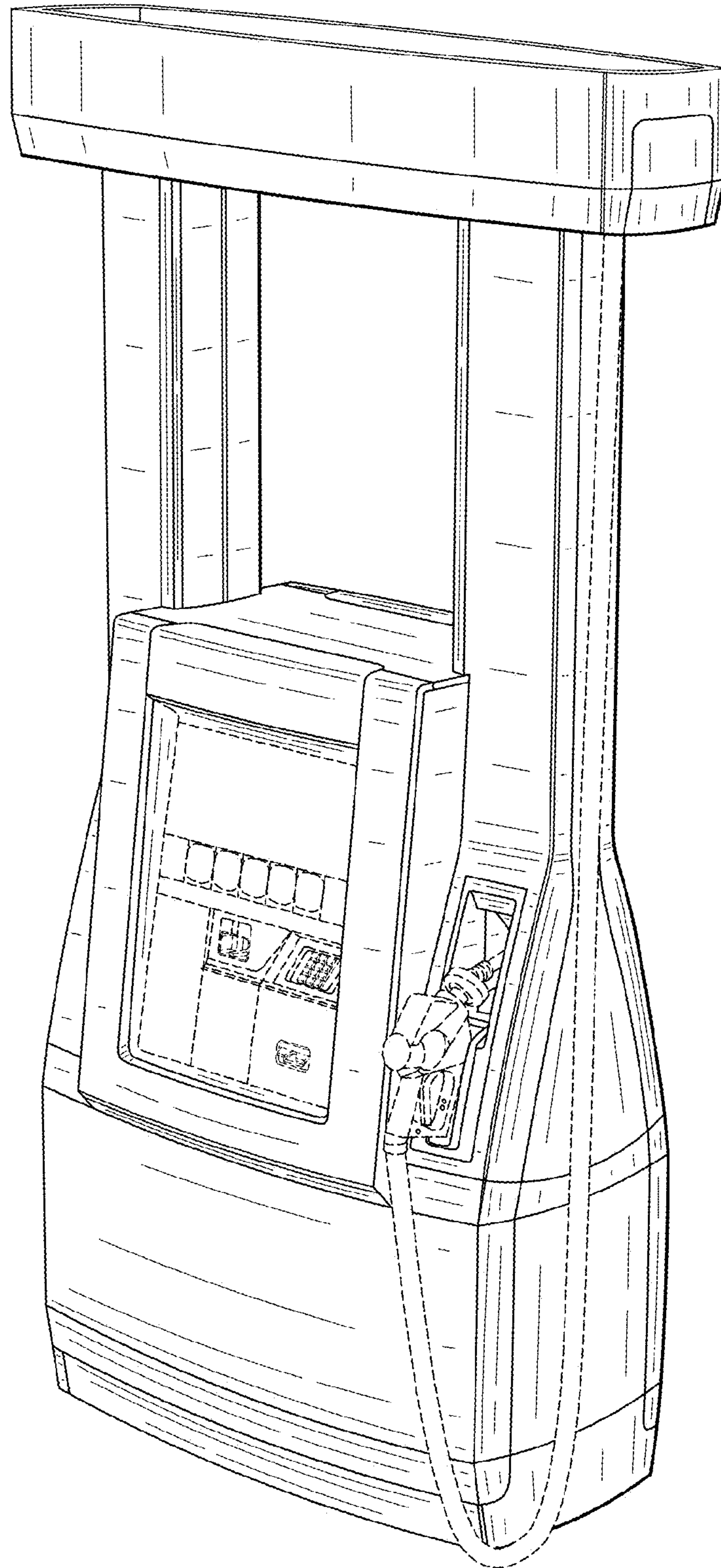

FIG. 2

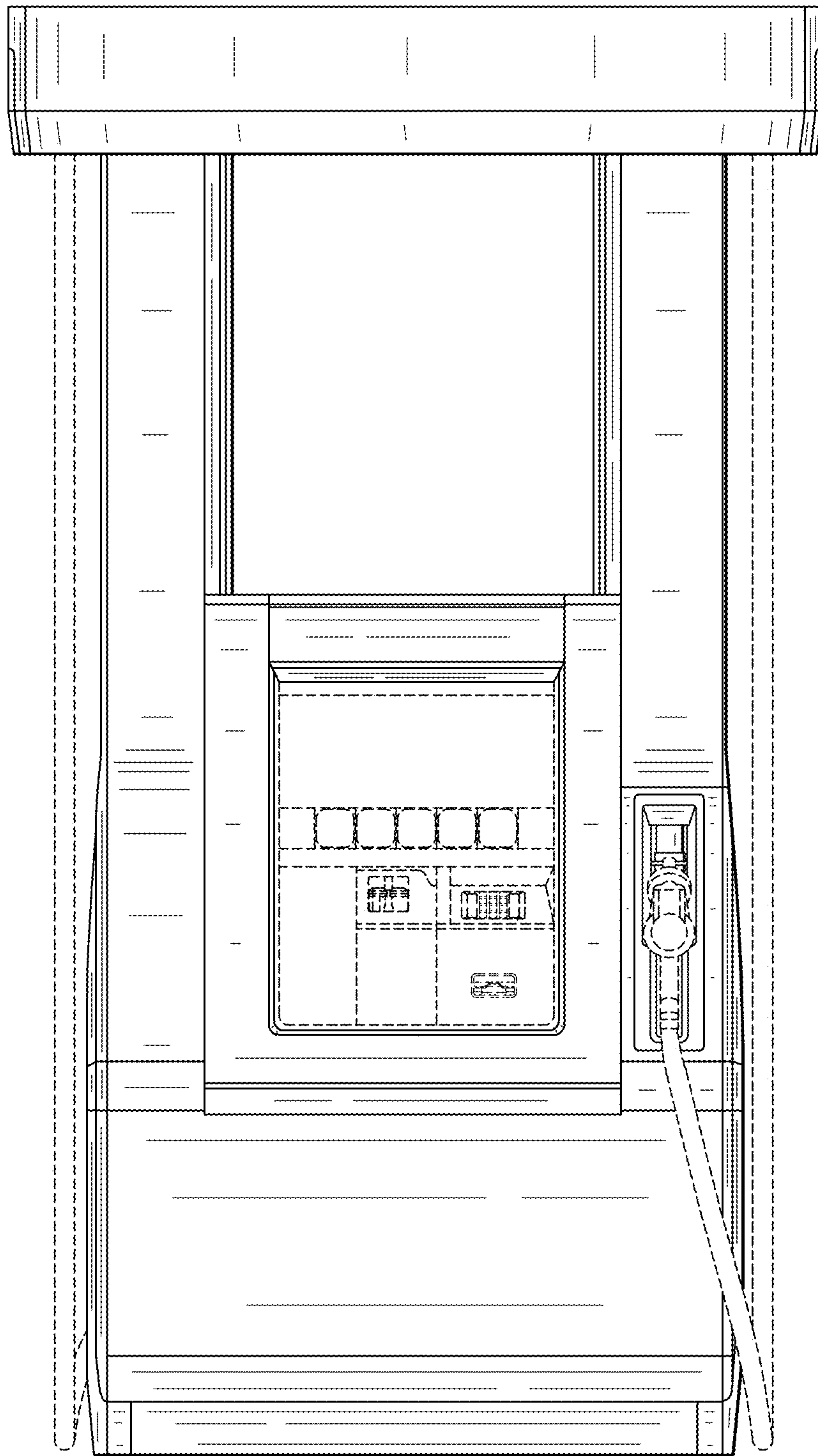

FIG. 3

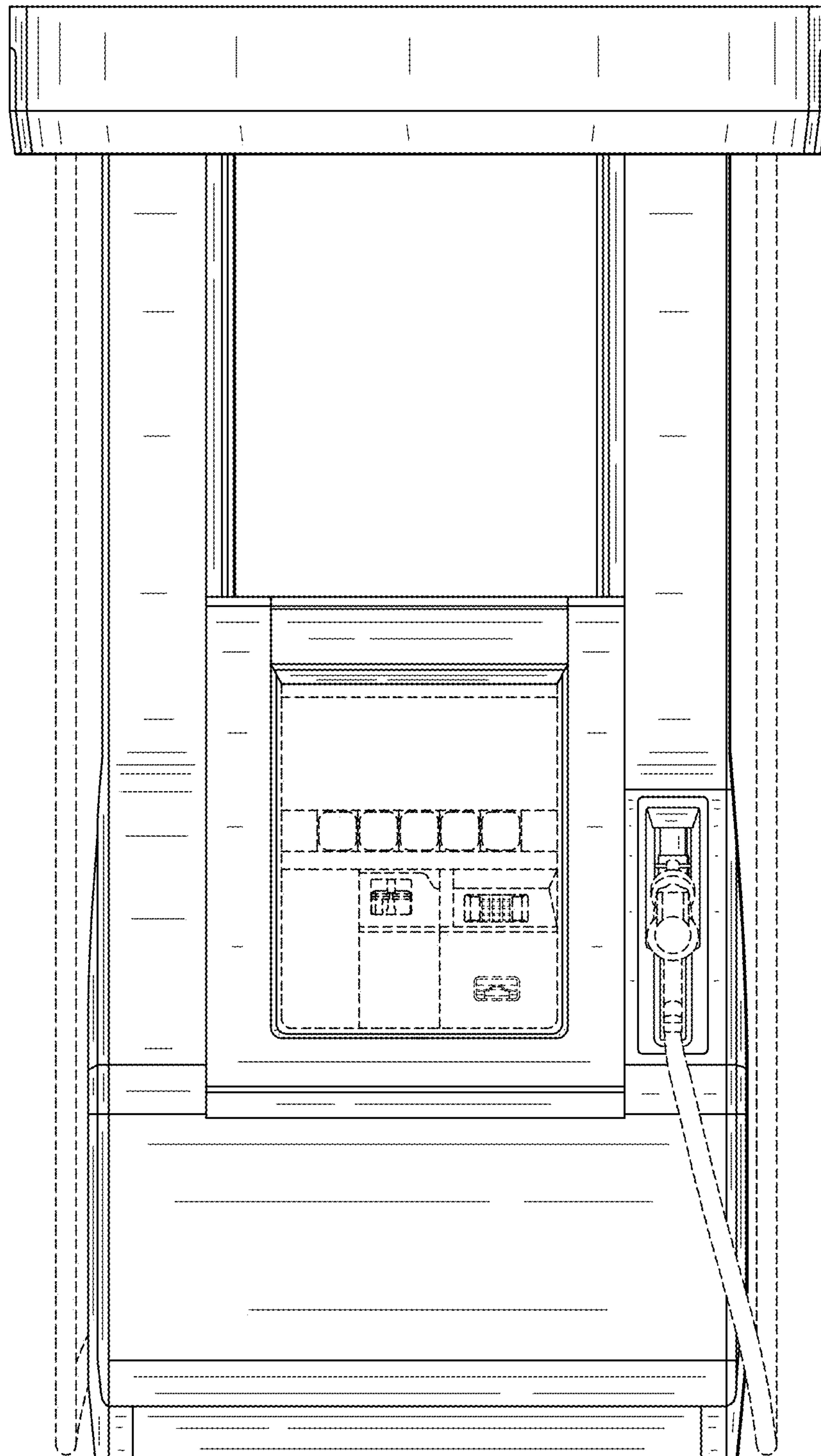

FIG. 4

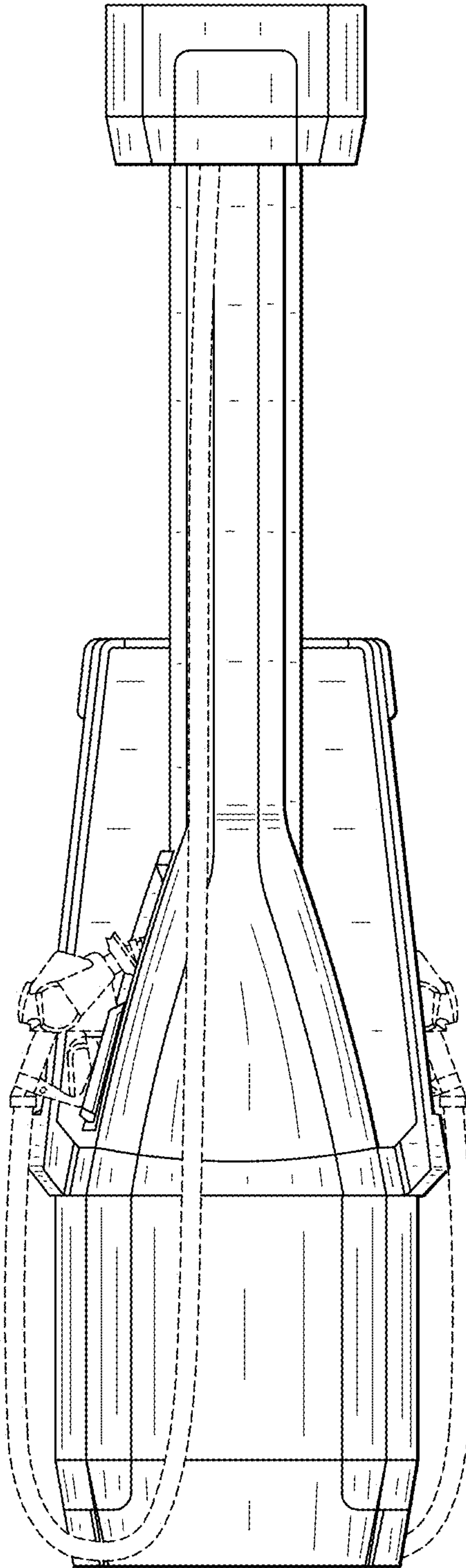

FIG. 5

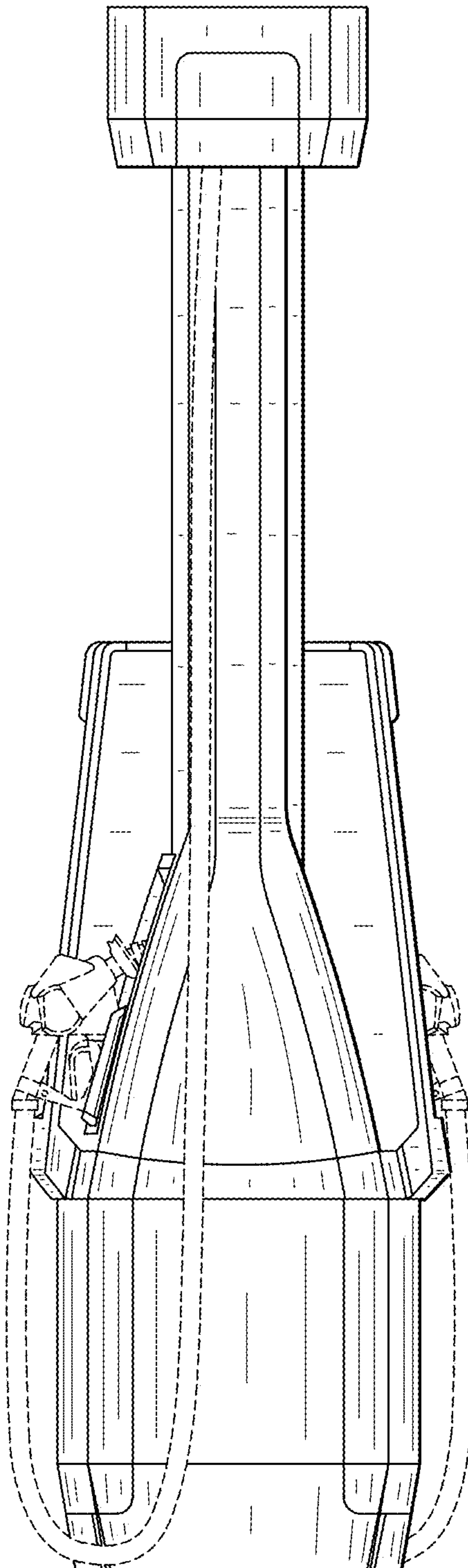

FIG. 6

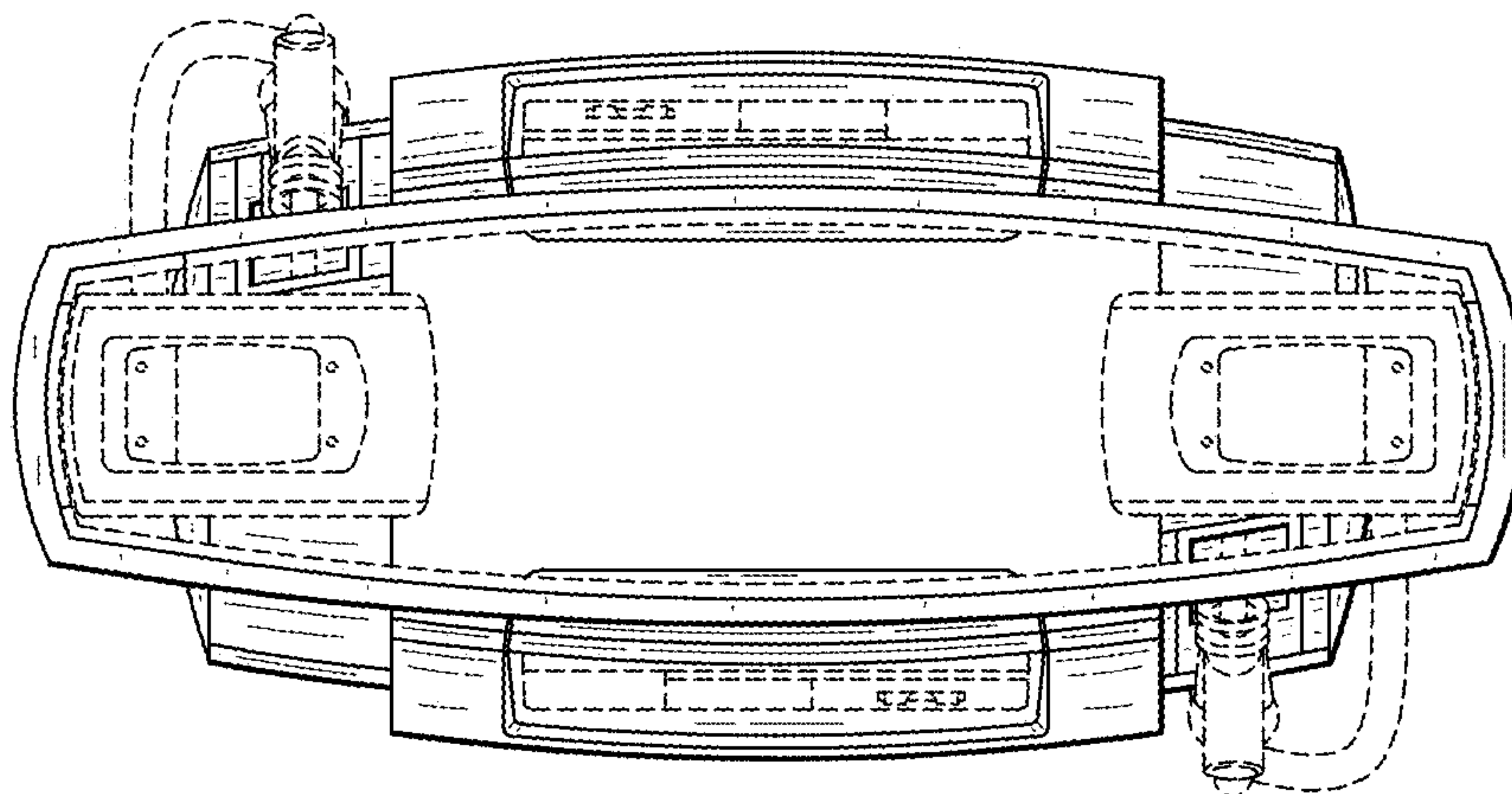

FIG. 7

