



US00D688237S

(12) **United States Design Patent**
Paulhac et al.

(10) **Patent No.:** **US D688,237 S**

(45) **Date of Patent:** **** Aug. 20, 2013**

(54) **COMBINED TABLET AND PERSONAL COMPUTER**

(75) Inventors: **Nicolas Daniel Paulhac**, New Taipei (TW); **Quentin-Augustin Hulot-Geoffroy**, New Taipei (TW)

(73) Assignee: **Acer Incorporated**, New Taipei (TW)

(**) Term: **14 Years**

(21) Appl. No.: **29/426,615**

(22) Filed: **Jul. 9, 2012**

(30) **Foreign Application Priority Data**

May 24, 2012 (TW) 101302990

(51) **LOC (9) Cl.** **14-02**

(52) **U.S. Cl.**
USPC **D14/315**

(58) **Field of Classification Search**
USPC D14/315-327, 331; D18/1, 2, 7, D18/11; 235/145 A, 145 R; 341/22, 23; 345/104, 156, 168, 169, 173; 361/679.06, 361/679.08, 679.09, 679.11, 679.26, 679.27; 379/433.12, 433.13

See application file for complete search history.

(56) **References Cited**

U.S. PATENT DOCUMENTS

5,103,376 A * 4/1992 Blonder 361/679.09
D421,972 S * 3/2000 Makidera et al. D14/316
D528,541 S * 9/2006 Maskatia D14/315
7,158,634 B2 * 1/2007 Eromaki 379/433.13
D580,930 S * 11/2008 Chien et al. D14/346
7,690,576 B2 * 4/2010 Ladouceur et al. 235/486
D626,547 S * 11/2010 Li et al. D14/316

2005/0044665 A1 * 3/2005 Kuramochi 16/341
2010/0285852 A1 * 11/2010 Stephenson 455/575.4
2012/0037285 A1 * 2/2012 Diebel et al. 150/165

* cited by examiner

Primary Examiner — Freda S Nunn

(74) *Attorney, Agent, or Firm* — Jianq Chyun IP Office

(57) **CLAIM**

The ornamental design for a combined tablet and personal computer, as shown and described.

DESCRIPTION

FIG. 1 is a front perspective view of a combined tablet and personal computer showing our new design in an open state; FIG. 2 is a rear perspective view thereof; FIG. 3 is a front view thereof; FIG. 4 is a rear view thereof; FIG. 5 is a left side view thereof; FIG. 6 is a right side view thereof; FIG. 7 is a top view thereof; FIG. 8 is a bottom view thereof; FIG. 9 is a front perspective view thereof in closed state; FIG. 10 is a rear perspective view thereof in closed state; FIG. 11 is a front view thereof in closed state; FIG. 12 is a rear view thereof in closed state; FIG. 13 is a left side view thereof in closed state; FIG. 14 is a right side view thereof in closed state; FIG. 15 is a top view thereof in closed state; FIG. 16 is a bottom view thereof in closed state; and, FIG. 17 is a front perspective view thereof in touchable state. The broken line portions of the combined tablet and personal computer in FIGS. 1-2, FIGS. 5-7, FIGS. 9-10, FIGS. 13-14 and FIG. 17 represent unclaimed portions of the claimed design and form no part thereof.

1 Claim, 17 Drawing Sheets

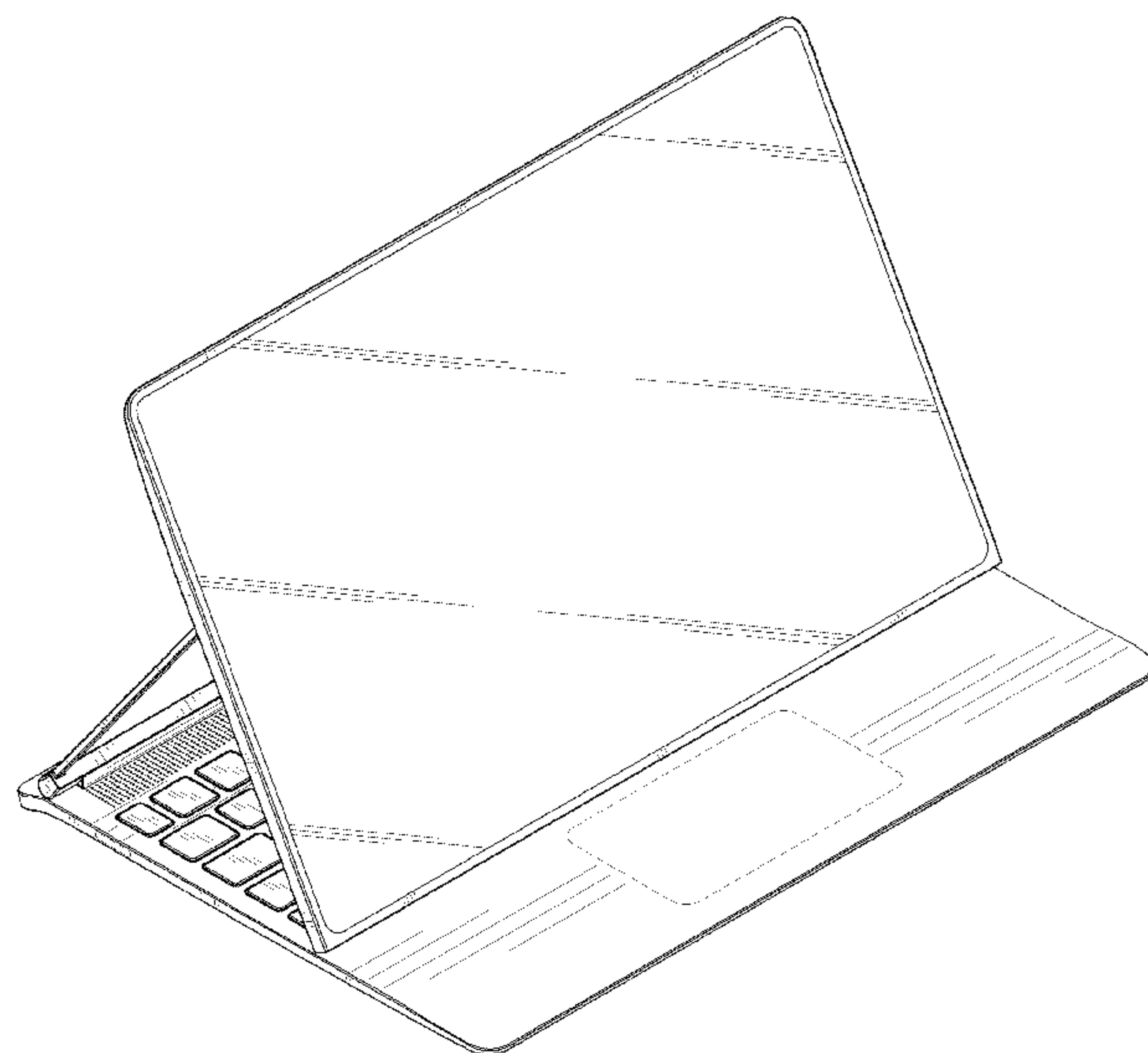
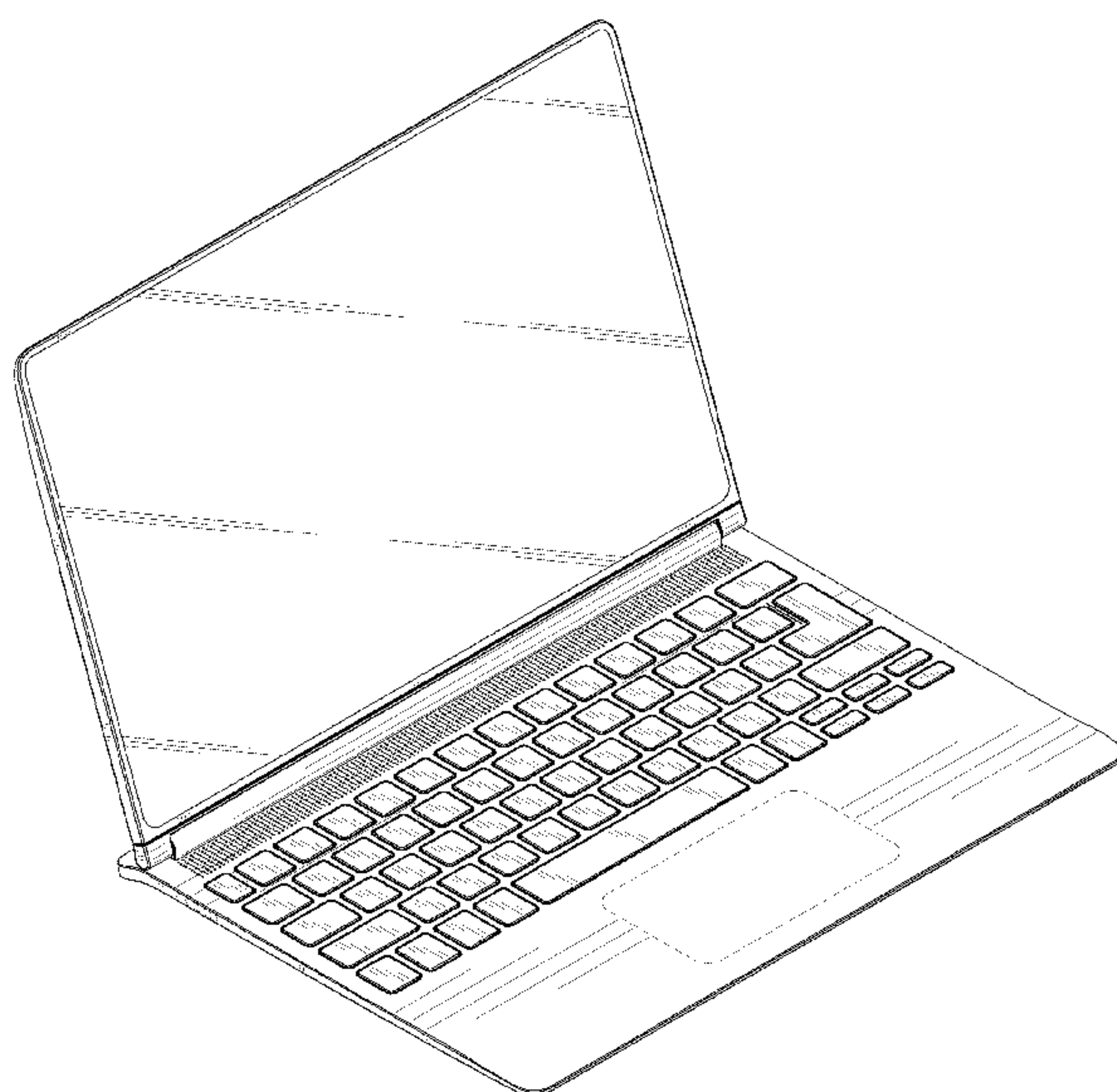

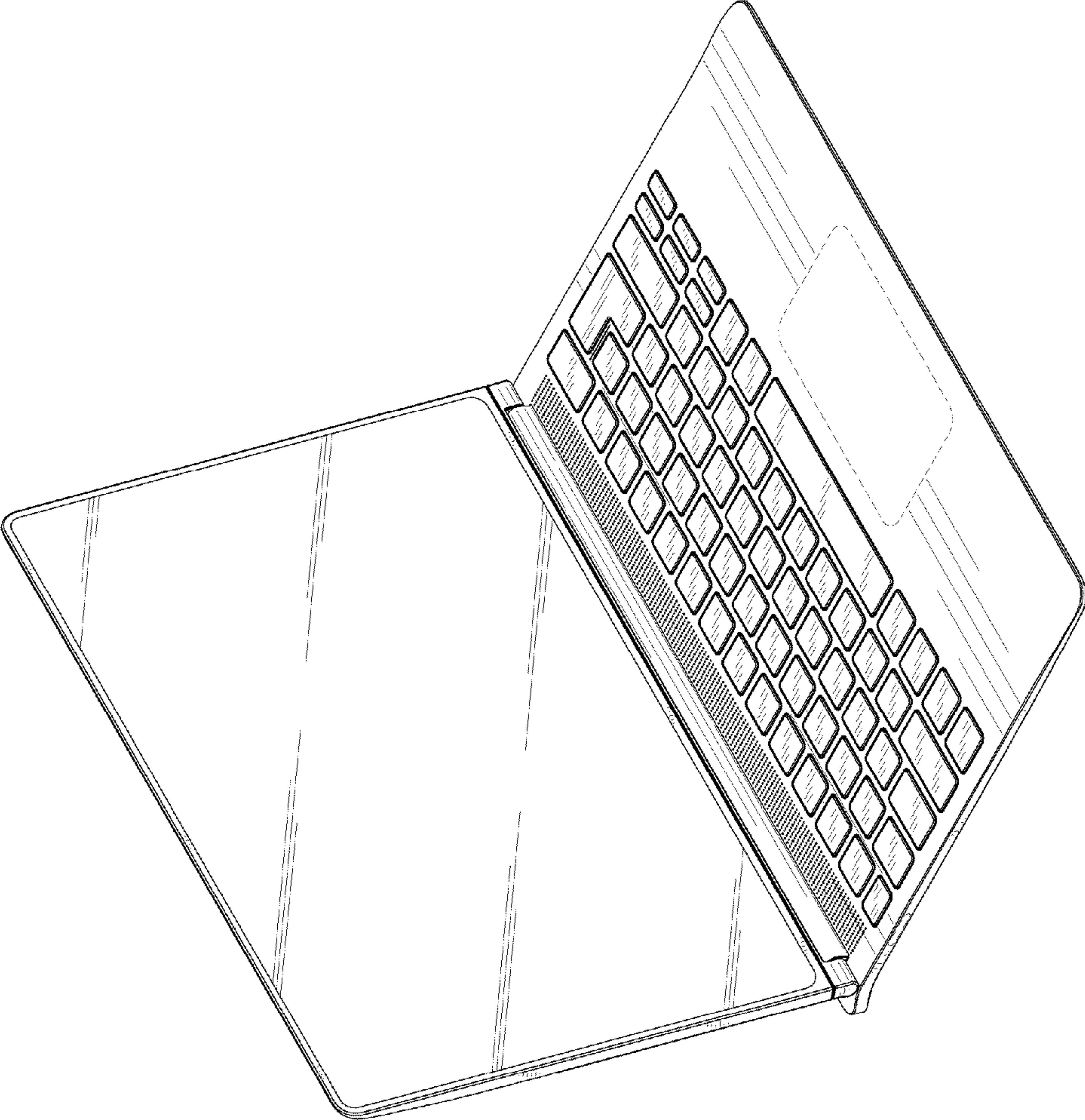

FIG. 1

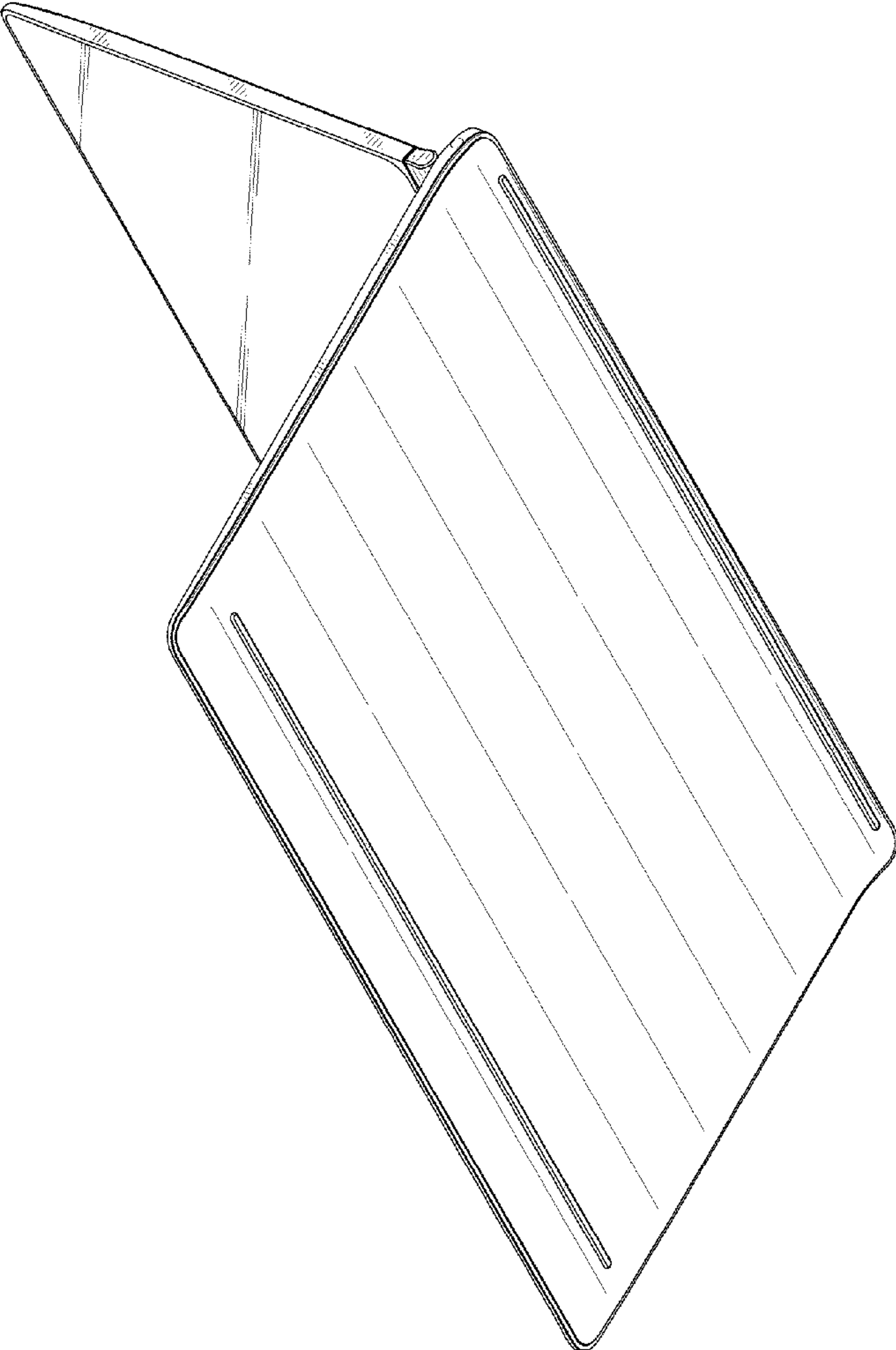

FIG. 2

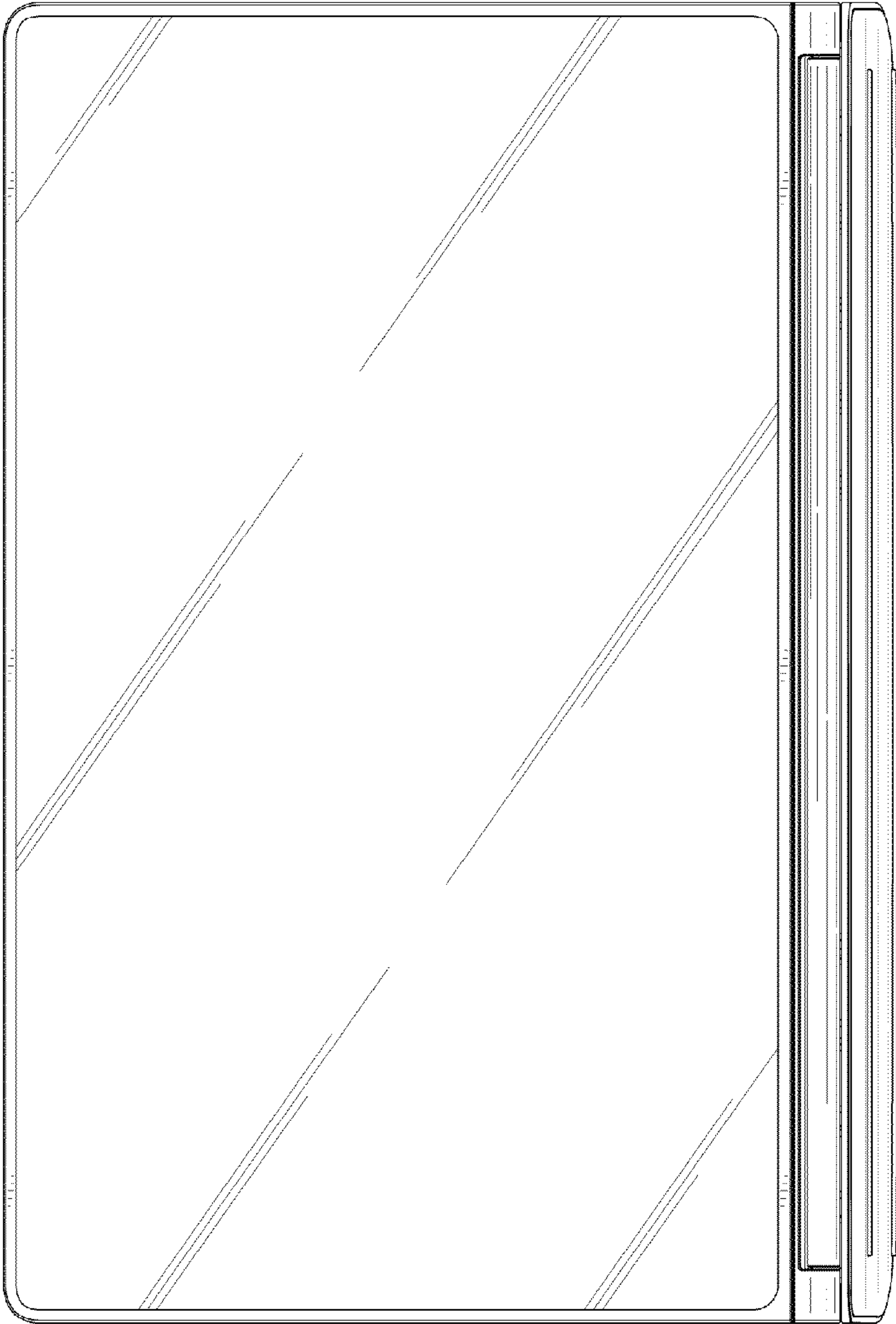

FIG. 3

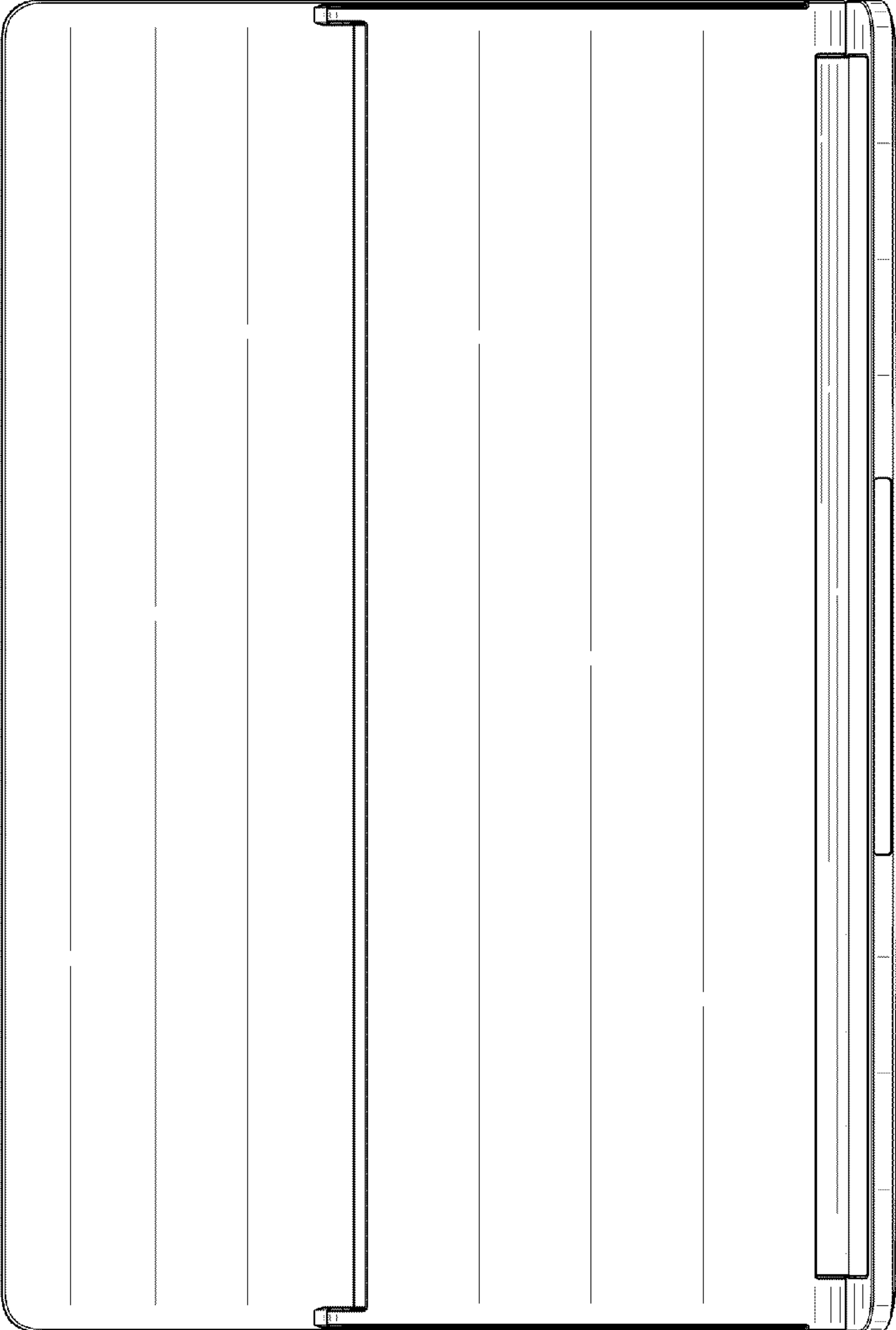

FIG. 4

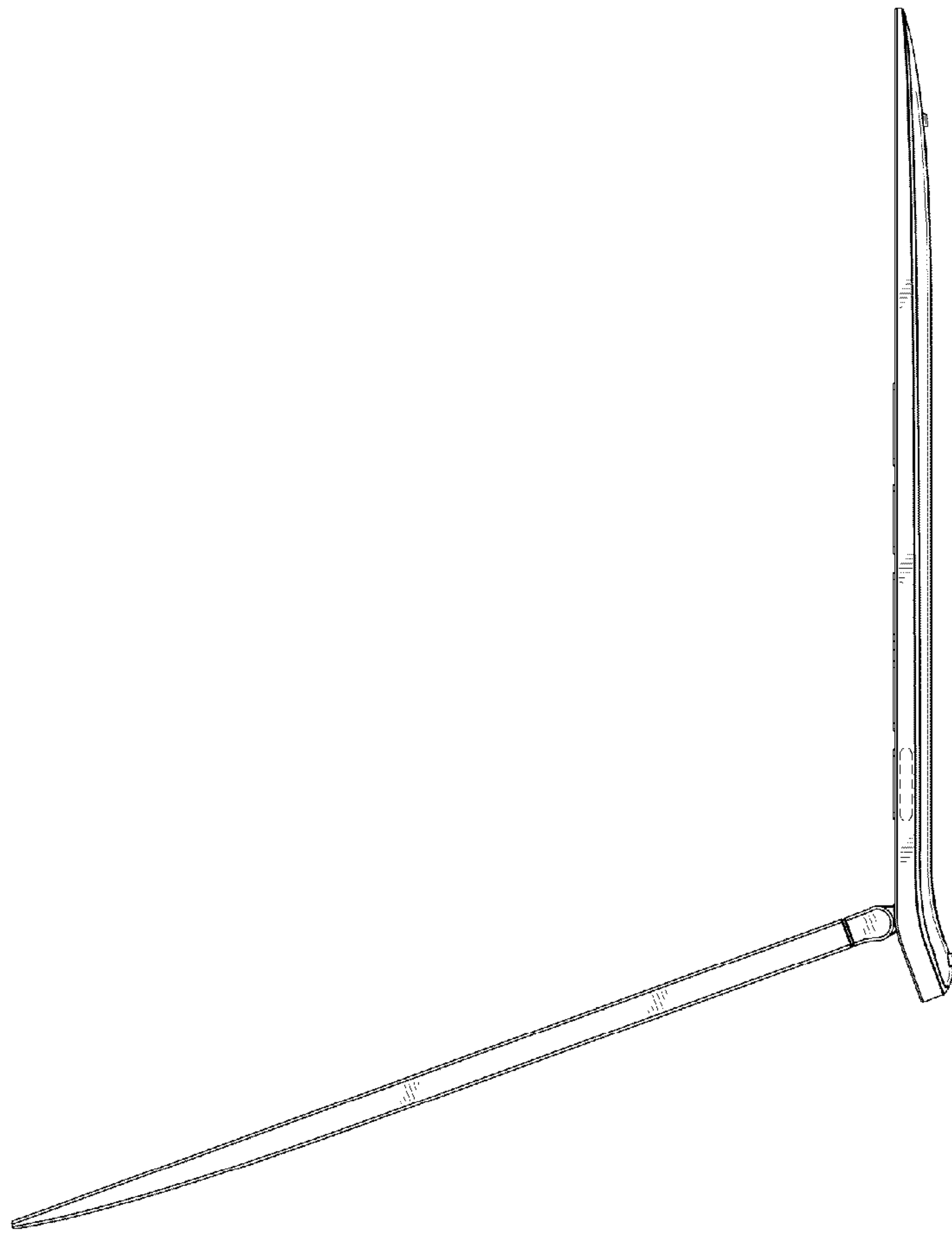

FIG. 5

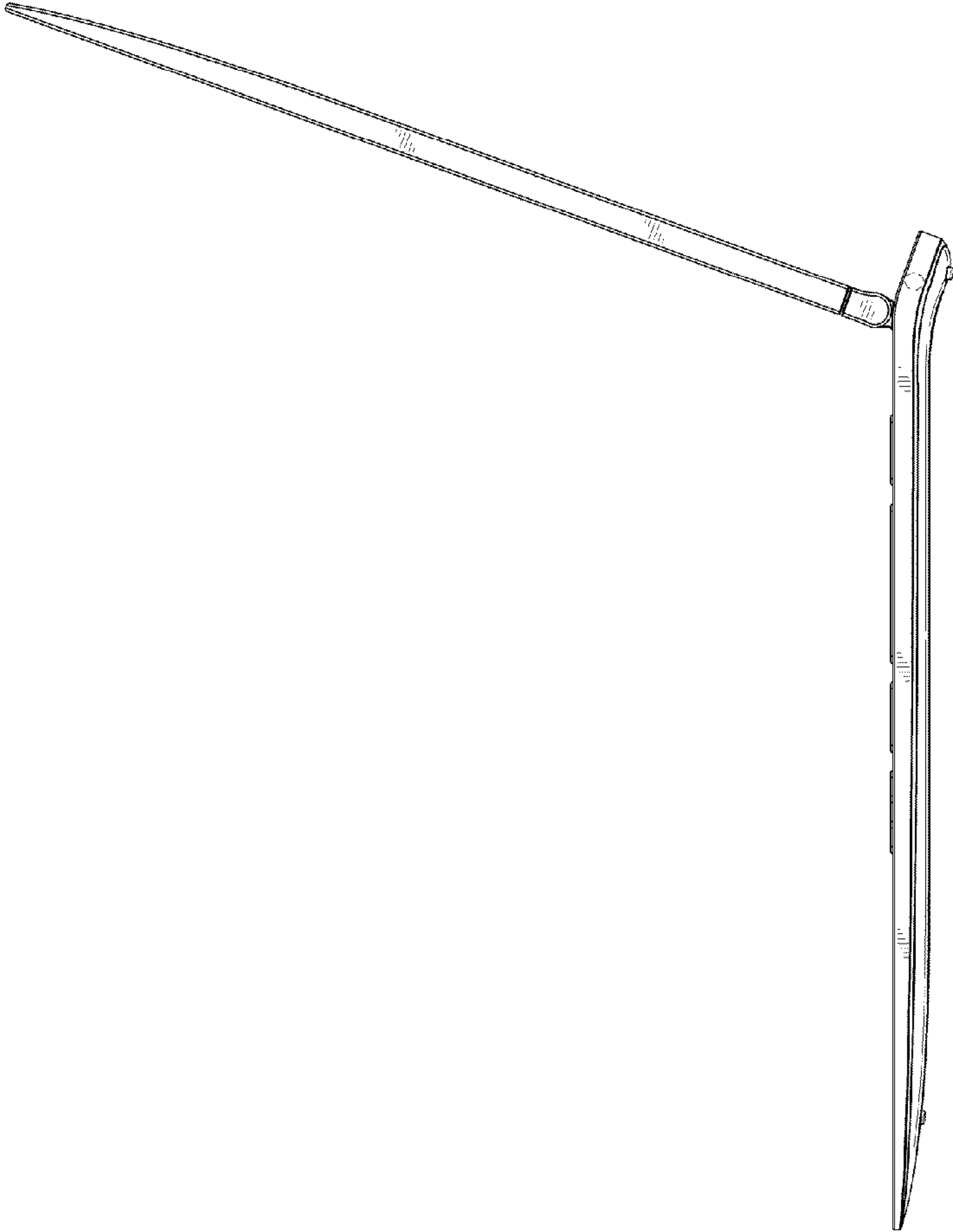

FIG. 6

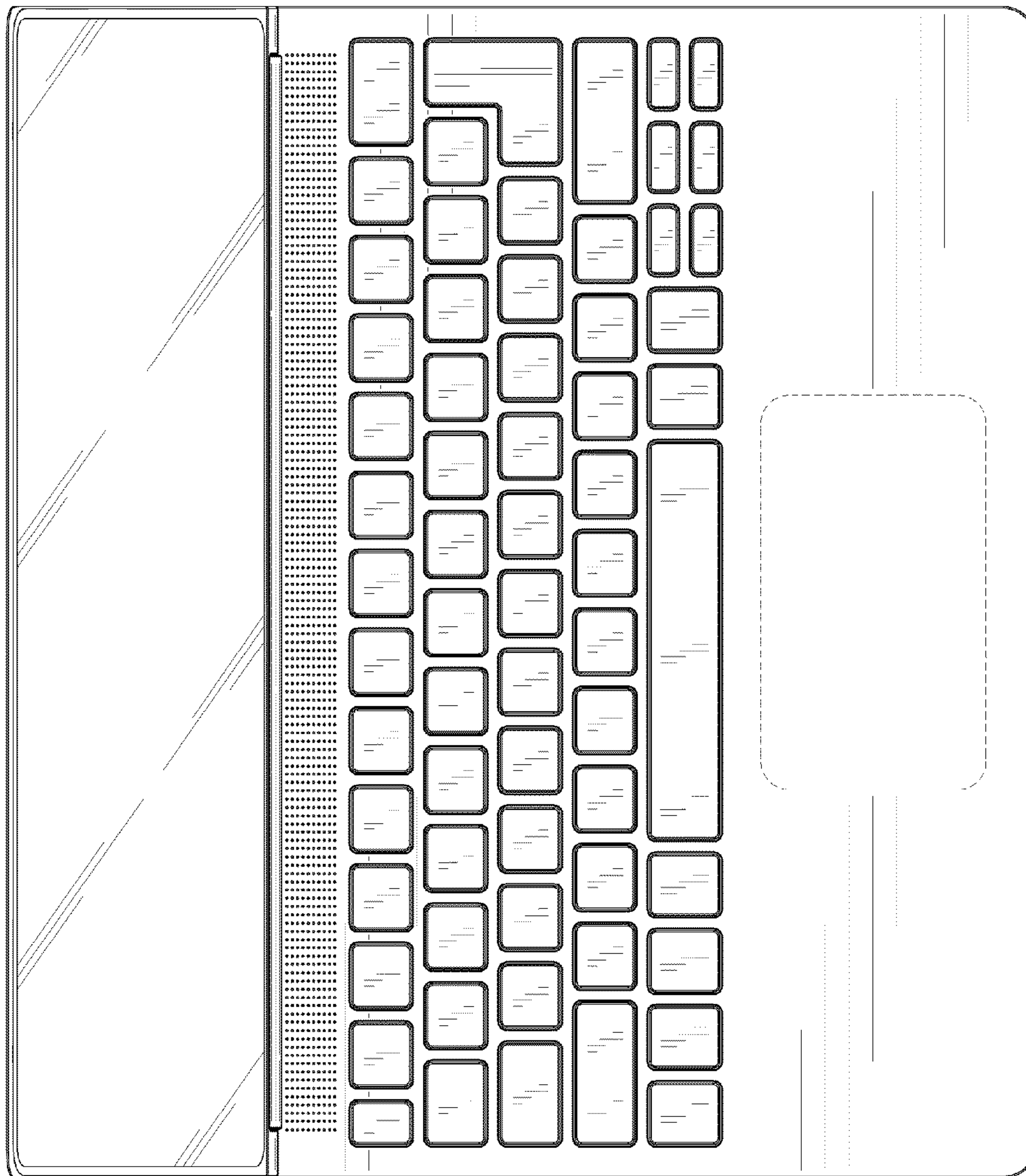

FIG. 7



FIG. 8

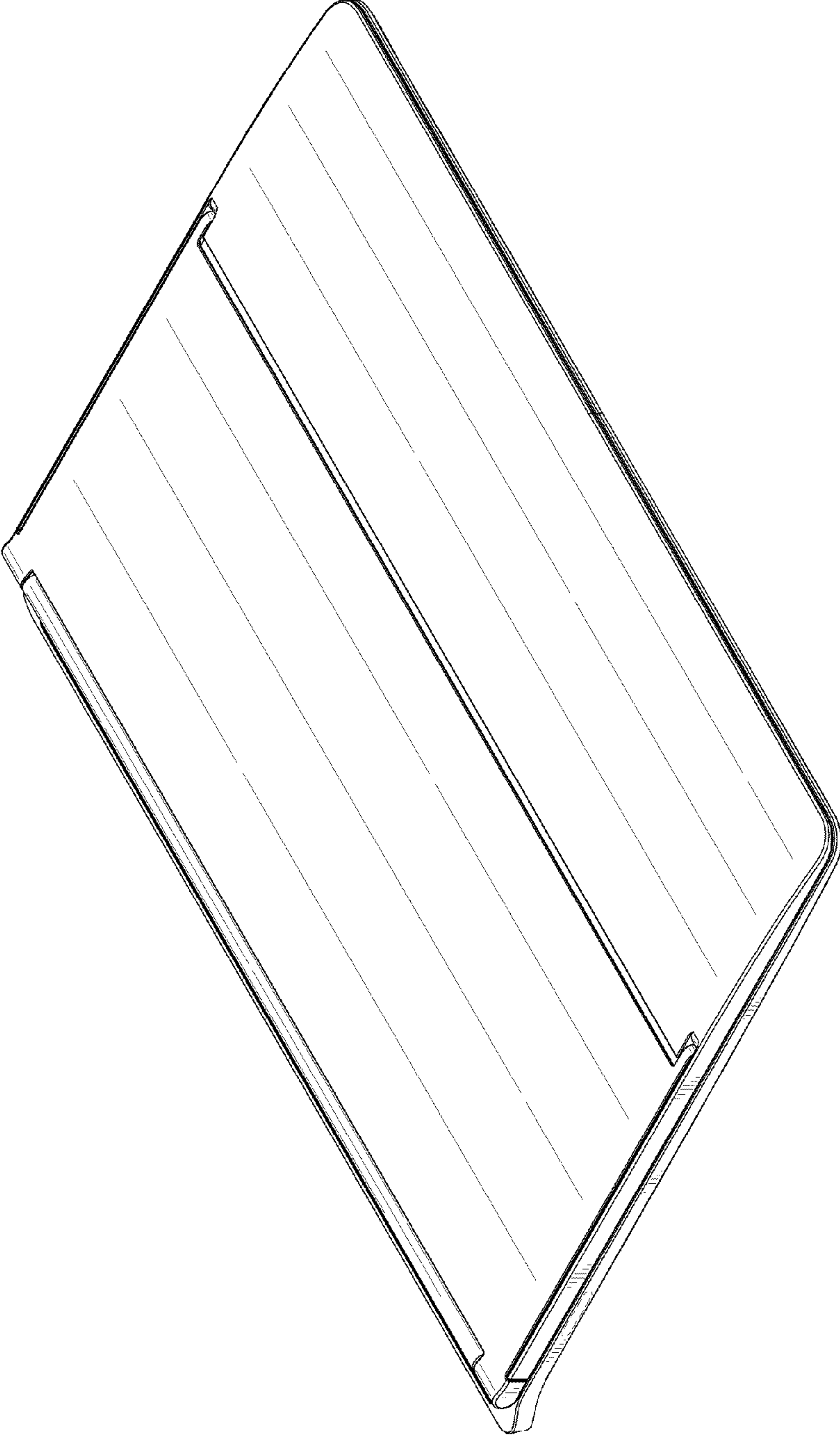

FIG. 9

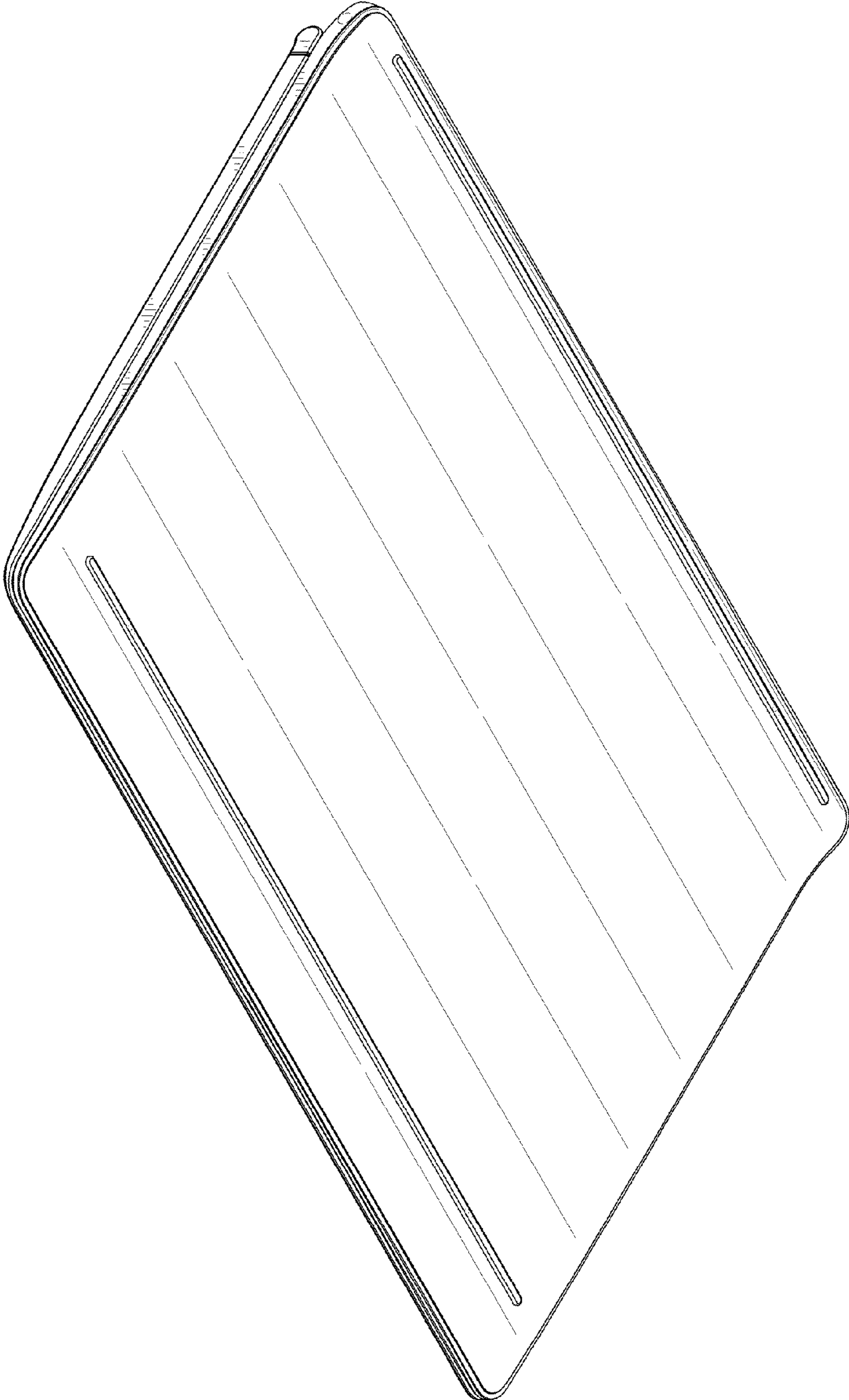

FIG. 10

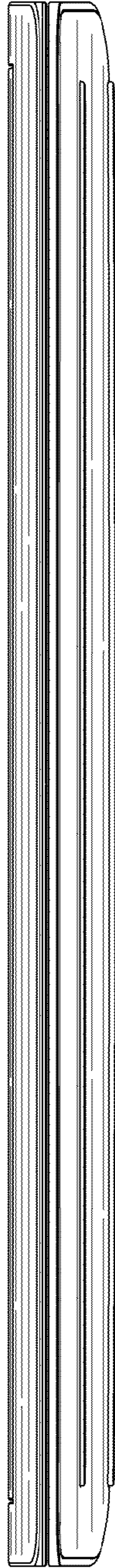

FIG. 11

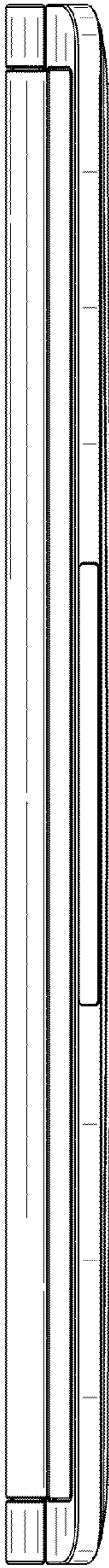

FIG. 12

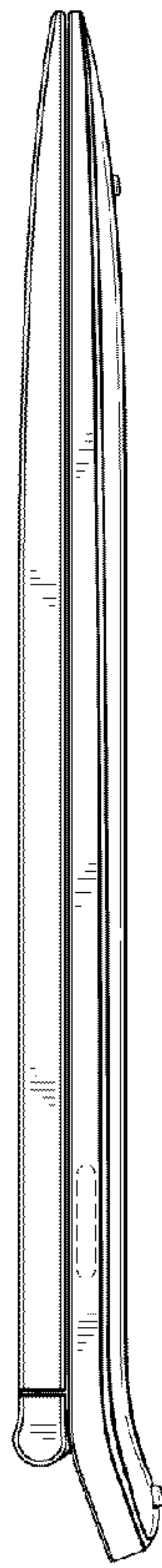

FIG. 13

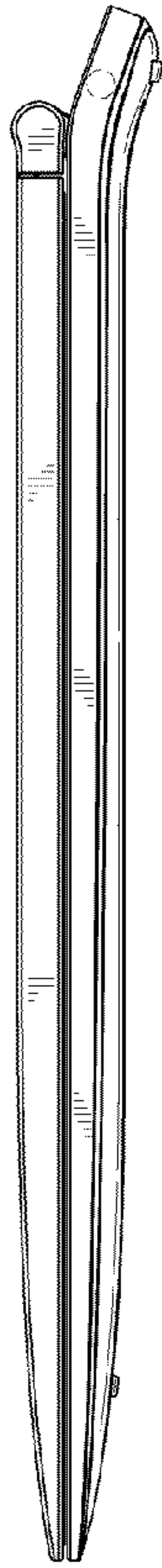

FIG. 14



FIG. 15

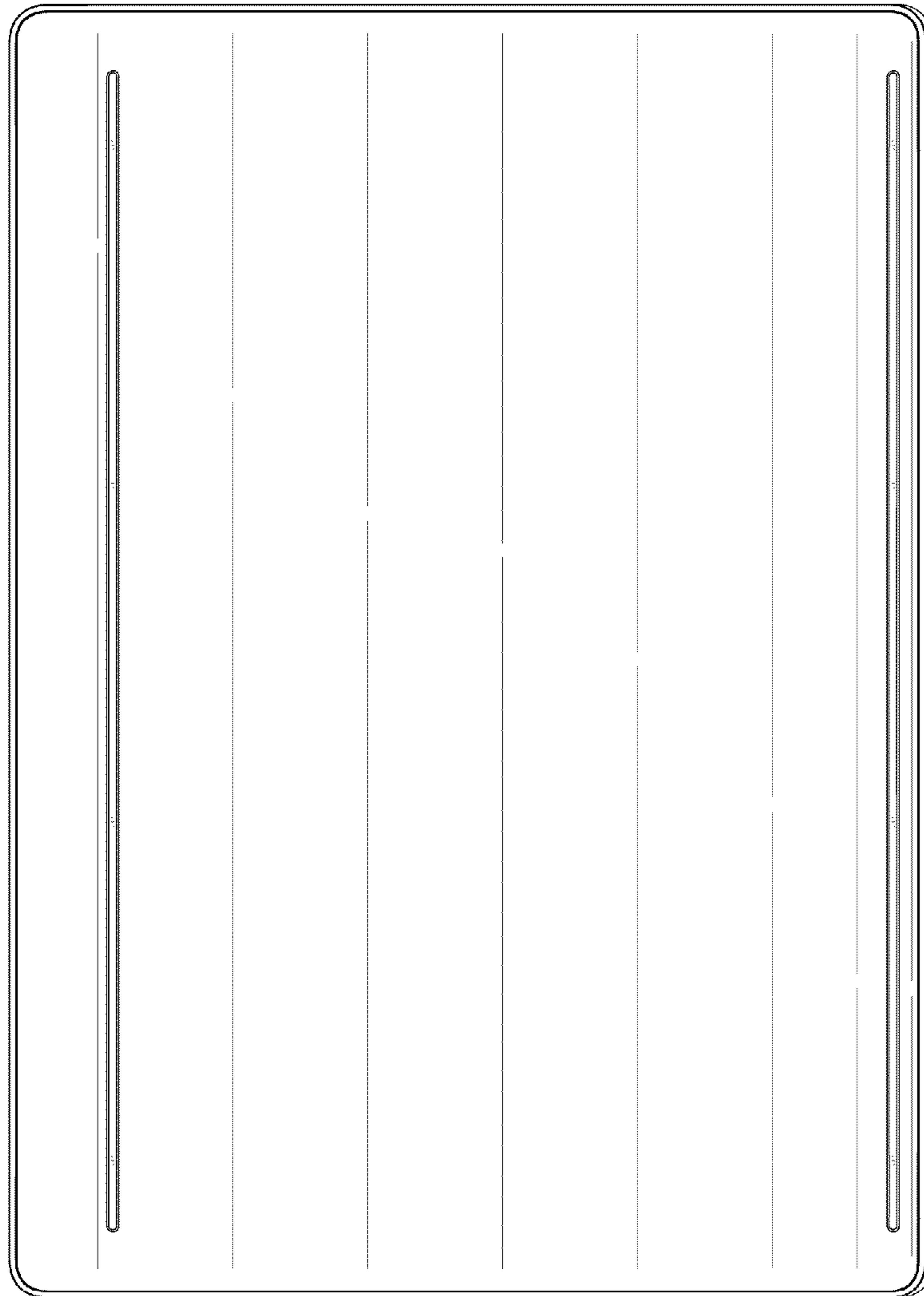

FIG. 16

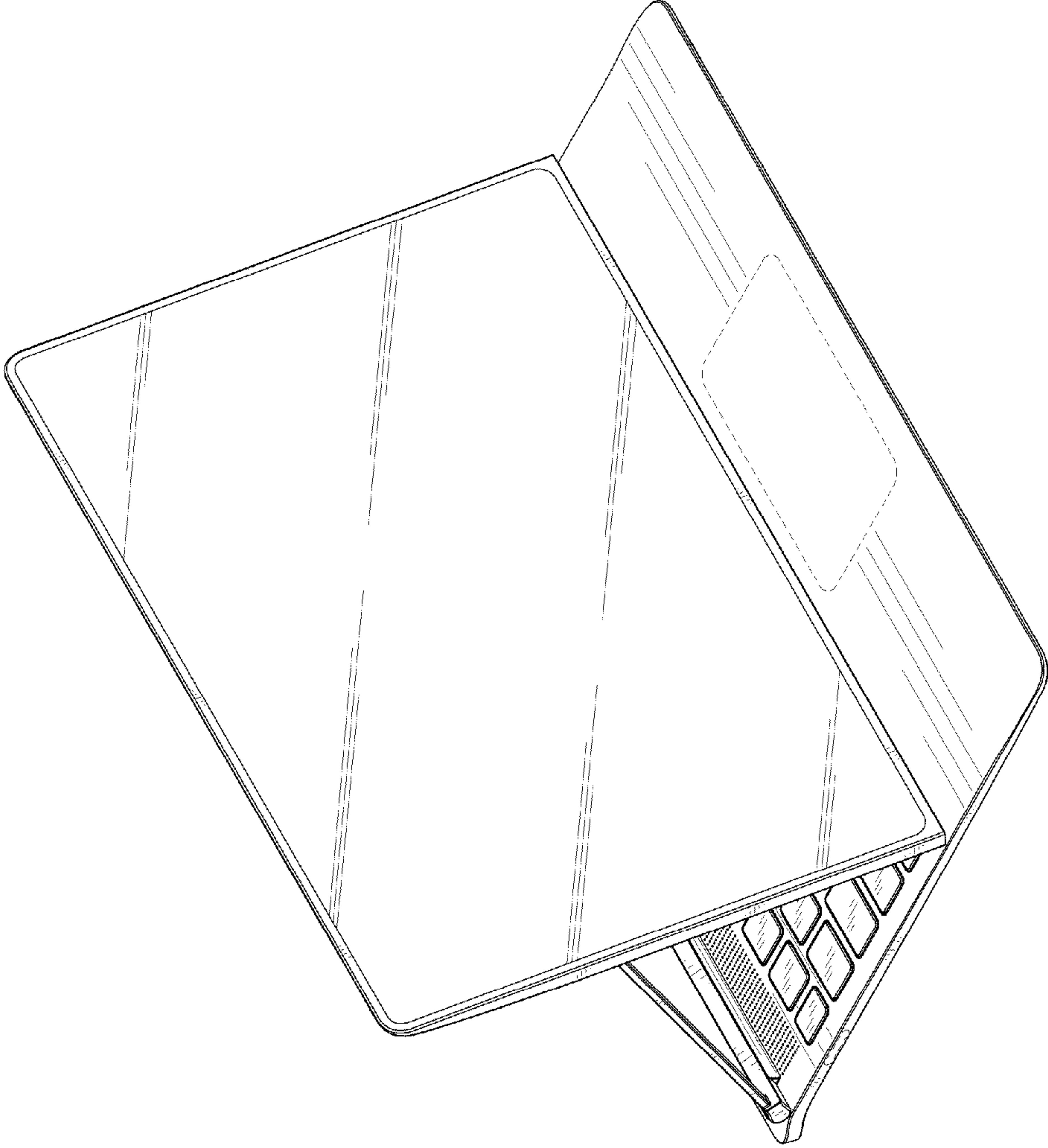

FIG. 17