



US00D688224S

(12) **United States Design Patent**
Kim et al.

(10) **Patent No.:** **US D688,224 S**

(45) **Date of Patent:** **** Aug. 20, 2013**

(54) **MOBILE TERMINAL**

(75) Inventors: **Kuk-Hwan Kim**, Seoul (KR);
Seog-Guen Kim, Seoul (KR); **Tae-Ho Kim**, Yongin-Si (KR)

(73) Assignee: **Samsung Electronics Co., Ltd.**,
Suwon-si (KR)

(**) Term: **14 Years**

(21) Appl. No.: **29/427,659**

(22) Filed: **Jul. 20, 2012**

(30) **Foreign Application Priority Data**

Mar. 6, 2012 (KR) 30-2012-0010558

(51) **LOC (9) Cl.** **14-03**

(52) **U.S. Cl.**
USPC **D14/138 G**

(58) **Field of Classification Search**
USPC D14/138 G, 138 AD, 341, 346, 138 R,
D14/138 AC, 496, 203.1, 203.4, 203.7, 248,
D14/218; 455/575.1, 556.2, 575.3, 575.4;
D21/517; 379/433.01, 433.04; D10/65,
D10/78, 104; D13/168

See application file for complete search history.

(56) **References Cited**

U.S. PATENT DOCUMENTS

D601,538 S * 10/2009 Hong D14/138 G
D601,539 S * 10/2009 Hong D14/138 G
D638,815 S * 5/2011 Lee et al. D14/138 G
D644,197 S * 8/2011 Lee et al. D14/138 G
D645,010 S * 9/2011 Lee et al. D14/138 G
D646,256 S * 10/2011 Kim D14/138 G
D646,662 S * 10/2011 Kim D14/138 G

D650,348 S * 12/2011 Li D14/138 G
D651,186 S * 12/2011 Park et al. D14/138 G
D654,041 S * 2/2012 Jung et al. D14/138 AD
D654,048 S * 2/2012 Ichinose et al. D14/138 G
D654,459 S * 2/2012 Kim D14/138 AD
D654,889 S * 2/2012 Kim et al. D14/138 G
D654,891 S * 2/2012 Kim et al. D14/138 G
D657,764 S * 4/2012 Hong D14/138 G
D663,278 S * 7/2012 Kim et al. D14/138 G
D663,710 S * 7/2012 Park D14/138 G

(Continued)

OTHER PUBLICATIONS

Samsung Galaxy Stellar 4G I200 telephone, announced Aug. 2012, [online], [site visited Mar. 19, 2013]. Available from Internet, <URL: http://www.gsmarena.com/samsung_galaxy_stellar_4g_i200-4954.php>.*

(Continued)

Primary Examiner — Jeffrey D Asch

(74) *Attorney, Agent, or Firm* — NSIP Law

(57) **CLAIM**

The ornamental design for a mobile terminal, as shown and described.

DESCRIPTION

FIG. 1 is a front perspective view of a mobile terminal; FIG. 2 is a front view of the mobile terminal of FIG. 1; FIG. 3 is a rear view of the mobile terminal of FIG. 1; FIG. 4 is a left-side view of the mobile terminal of FIG. 1; FIG. 5 is a right-side view of the mobile terminal of FIG. 1; FIG. 6 is a top plan view of the mobile terminal of FIG. 1; and, FIG. 7 is a bottom plan view of the mobile terminal of FIG. 1. Features shown in broken lines in FIGS. 1, 2, 4, and 5 form no part of the claimed design.

1 Claim, 5 Drawing Sheets

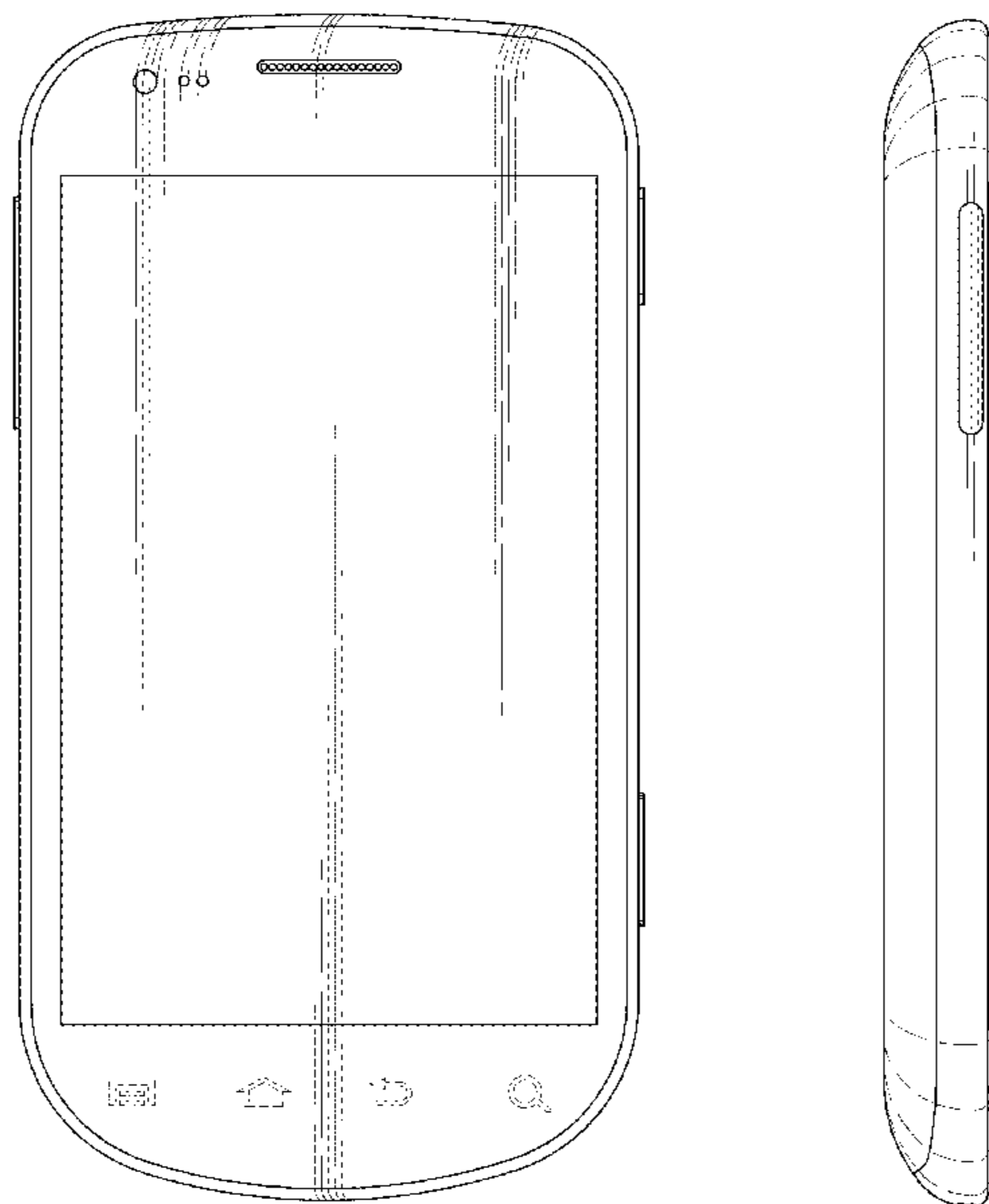

(56)

References Cited

U.S. PATENT DOCUMENTS

D666,569	S	*	9/2012	Kim et al.	D14/138	AD
D666,570	S	*	9/2012	Kim et al.	D14/138	G
D666,571	S	*	9/2012	Kim et al.	D14/138	G
D666,572	S	*	9/2012	Kim et al.	D14/138	G
D676,401	S	*	2/2013	Choi	D14/138	G
D676,821	S	*	2/2013	Jeong	D14/138	G
D676,824	S	*	2/2013	Lee	D14/138	G
2006/0205451	A1	*	9/2006	Pan	455/575.4	

OTHER PUBLICATIONS

Samsung Galaxy Proclaim S720C telephone, announced May 2012, [online], [site visited Mar. 19, 2013]. Available from Internet, <URL: http://www.gsmarena.com/samsung_galaxy_proclaim_s720c-4754.php>.*

Samsung Exhilarate i577 telephone, announced Jan. 2012, [online], [site visited Mar. 19, 2013]. Available from Internet, <URL: http://www.gsmarena.com/samsung_exhilarate_i577-4415.php>.*

Samsung I110 Illusion telephone, announced Nov. 2011, [online], [site visited Mar. 19, 2013]. Available from Internet, <URL: http://www.gsmarena.com/samsung_i110_illusion-4344.php>.*

Samsung Dart T499 telephone, announced May 2011, [online], [site visited Mar. 19, 2013]. Available from Internet, <URL: http://www.gsmarena.com/samsung_dart_t499-4055.php>.*

Samsung Epic 4G telephone, announced Jun. 2010, [online], [site visited Mar. 19, 2013]. Available from Internet, <URL: http://www.gsmarena.com/samsung_epic_4g-3410.php>.*

Samsung Galaxy Reverb M950 telephone, announced Aug. 2011, [online], [site visited Mar. 19, 2013]. Available from Internet, <URL: http://www.gsmarena.com/samsung_galaxy_reverb_m950-4953.php>.*

Icemobile Apollo Touch telephone, announced Aug. 2012, [online], [site visited Mar. 19, 2013]. Available from Internet, <URL: http://www.gsmarena.com/icemobile_apollo_touch-5074.php>.*

* cited by examiner

FIG. 1

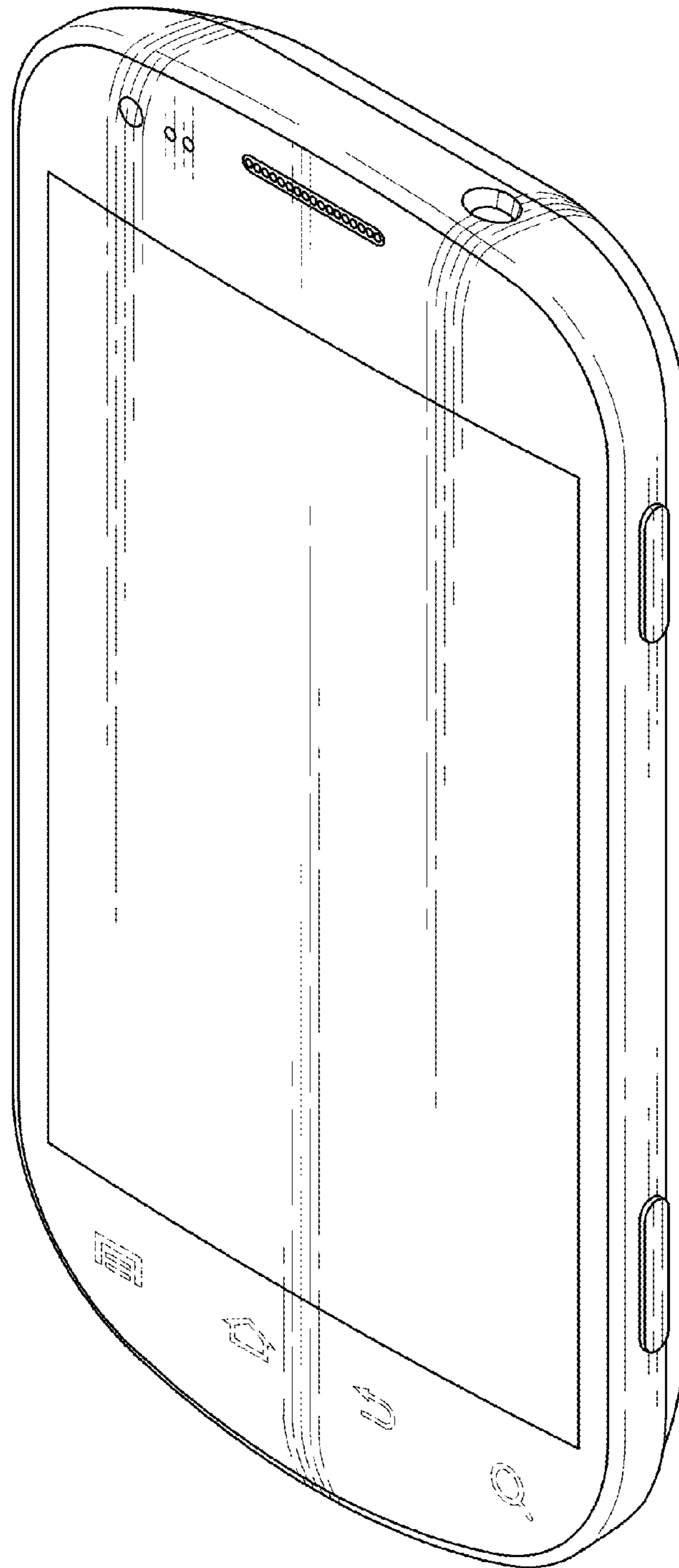

FIG. 2

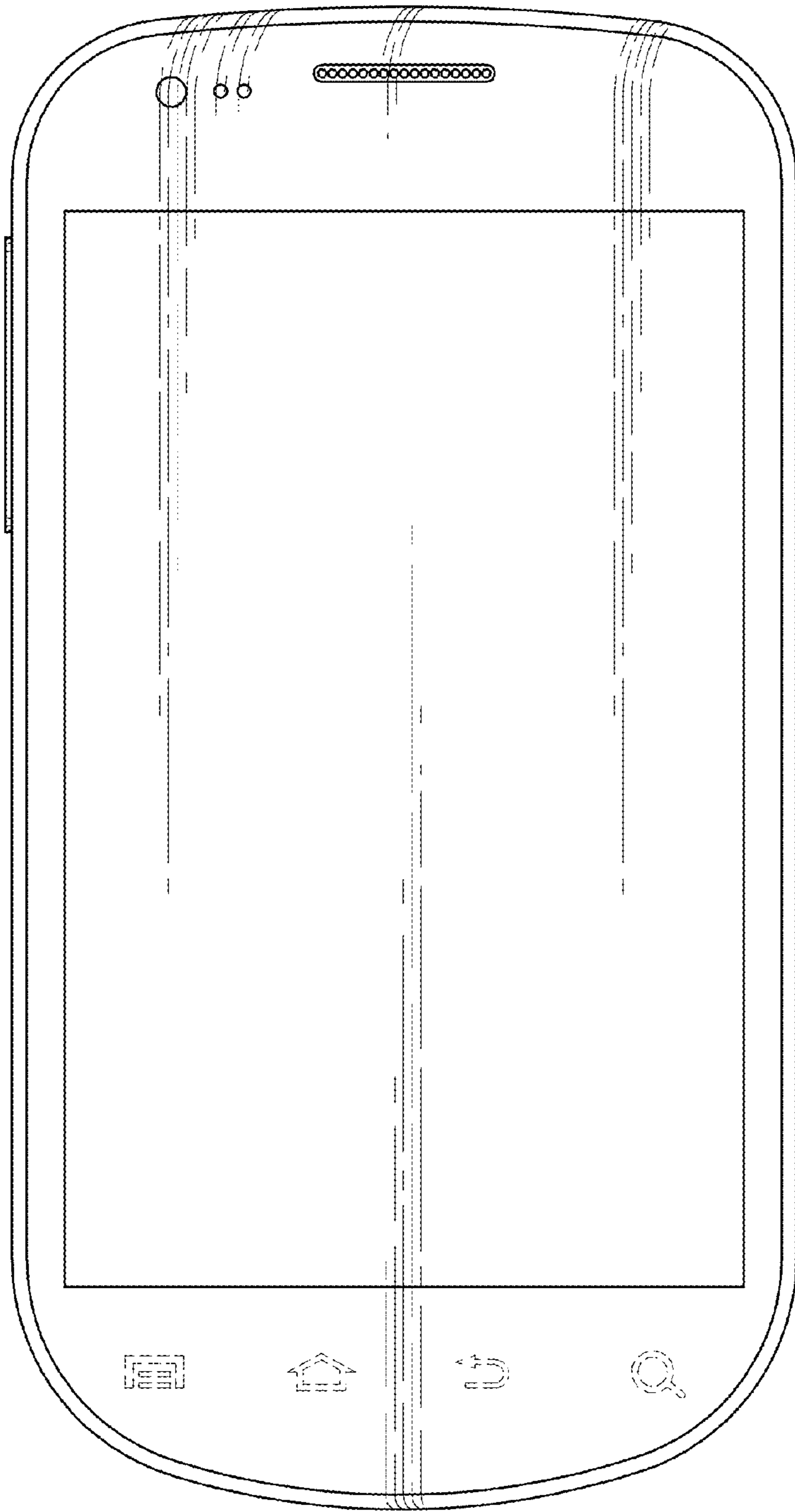

FIG. 3

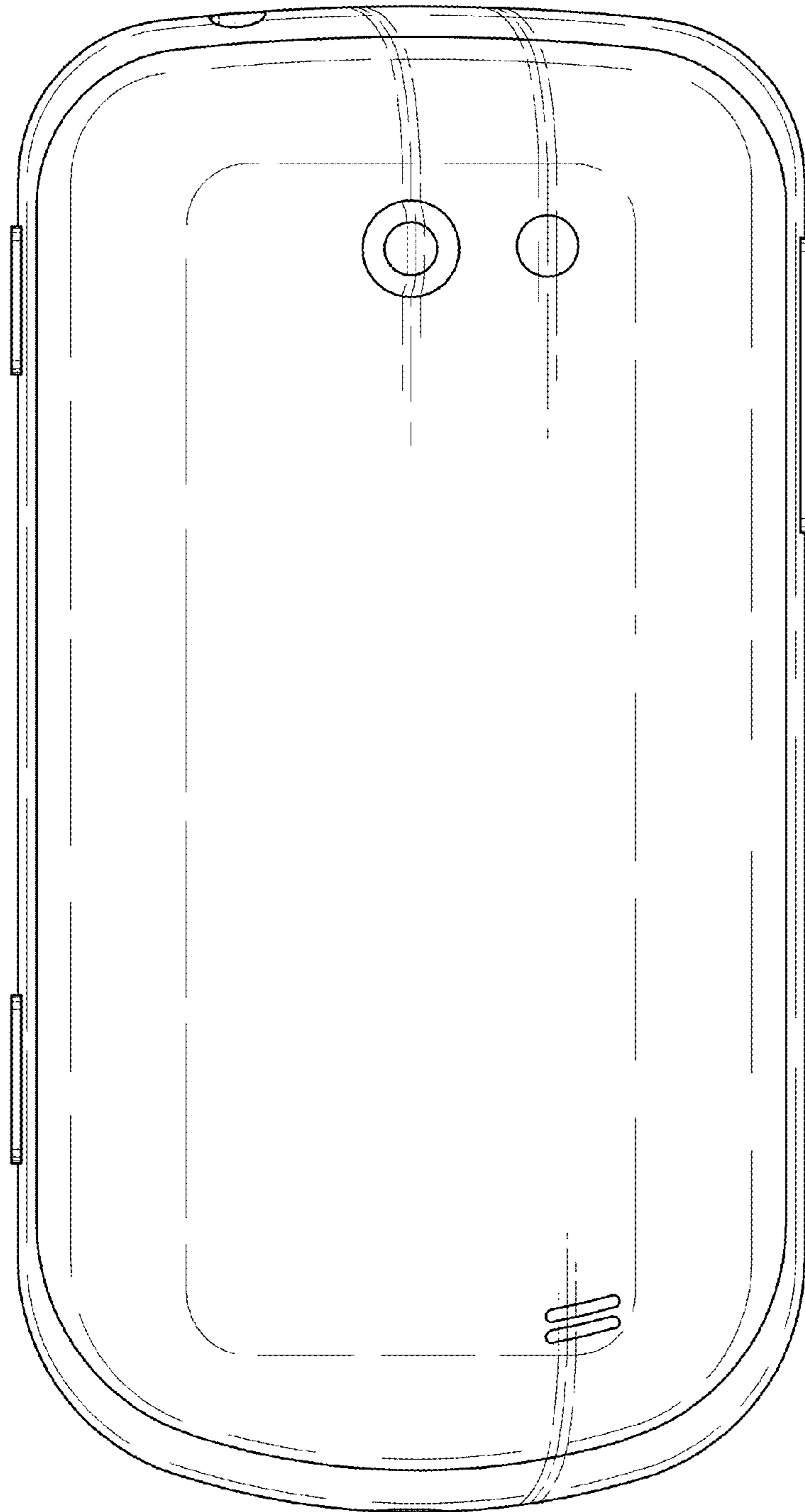

FIG. 4

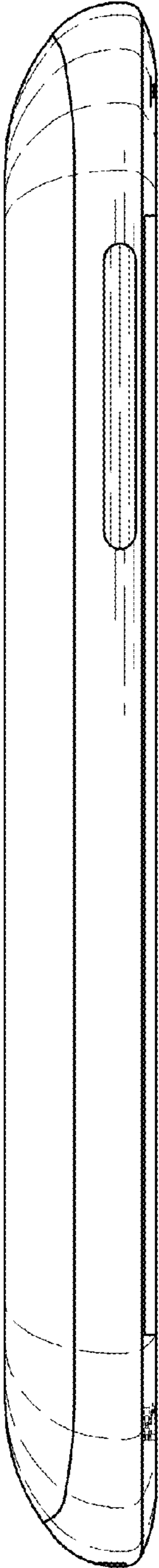

FIG. 5

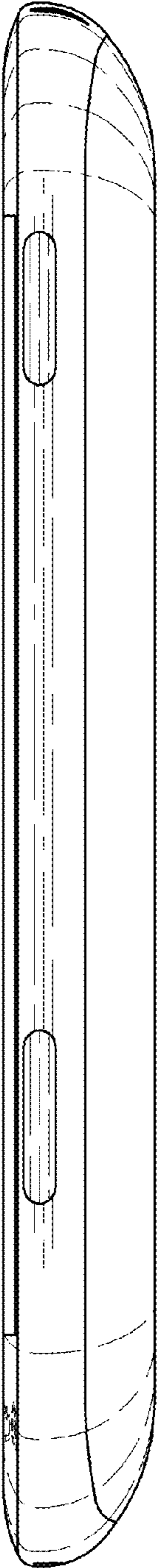

FIG. 6

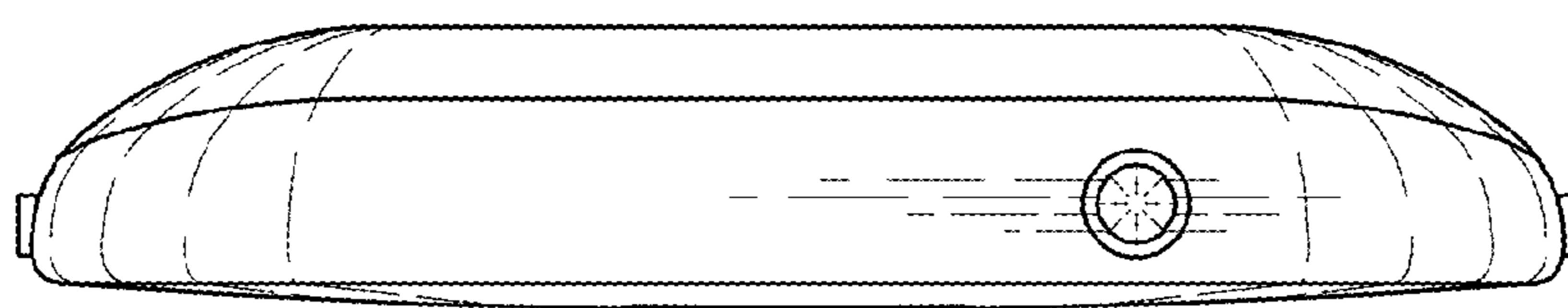

FIG. 7

