



US00D688139S

(12) **United States Design Patent**
Larkin et al.

(10) **Patent No.:** **US D688,139 S**

(45) **Date of Patent:** **** Aug. 20, 2013**

(54) **CONTAINER**

(75) Inventors: **Robert G. Larkin**, Johnston, IA (US);
Joanna C. Reynolds, Elmhurst, IL (US);
Aaron F. Fitchko, Huxley, IA (US)

(73) Assignee: **ACH Food Companies, Inc.**, Cordova,
TN (US)

(**) Term: **14 Years**

(21) Appl. No.: **29/432,094**

(22) Filed: **Sep. 13, 2012**

(51) **LOC (9) Cl.** **09-05**

(52) **U.S. Cl.**
USPC **D9/709**

(58) **Field of Classification Search**
USPC D9/702-714, 720-722, 414, 434-435,
D9/696, 716, 771, 447, 516-517, 738-747,
D9/544; D24/118, 207; 383/6, 9, 22, 96,
383/61.1, 80-81, 104, 901, 63, 203, 107,
383/119-120, 123; 220/675; 215/381-385,
215/400; 206/484; D3/202; 428/34.3
See application file for complete search history.

(56) **References Cited**

U.S. PATENT DOCUMENTS

D465,726 S * 11/2002 Tet D9/708
D620,810 S * 8/2010 Ehmer et al. D9/709

D639,185 S * 6/2011 Hung D9/709
D645,762 S * 9/2011 Hong et al. D9/710
D654,372 S * 2/2012 Hung D9/710
D663,219 S * 7/2012 McClellan et al. D9/709
D669,795 S * 10/2012 Larkin et al. D9/707
D674,290 S * 1/2013 Berman D9/707
D676,763 S * 2/2013 Kenmotsu et al. D9/707

* cited by examiner

Primary Examiner — Caron D Veynar

Assistant Examiner — Abraham Bahta

(74) *Attorney, Agent, or Firm* — Frost Brown Todd LLC

(57) **CLAIM**

The ornamental design for a container, as shown and described.

DESCRIPTION

FIG. 1 is a top perspective view of a container, showing our new design;
FIG. 2 is a bottom perspective view thereof;
FIG. 3 is a left elevation view thereof, the opposite side being a mirror image of the side shown;
FIG. 4 is a front elevation view thereof;
FIG. 5 is a back elevation view thereof;
FIG. 6 is a top plan view thereof; and,
FIG. 7 is a bottom plan view thereof.

1 Claim, 6 Drawing Sheets

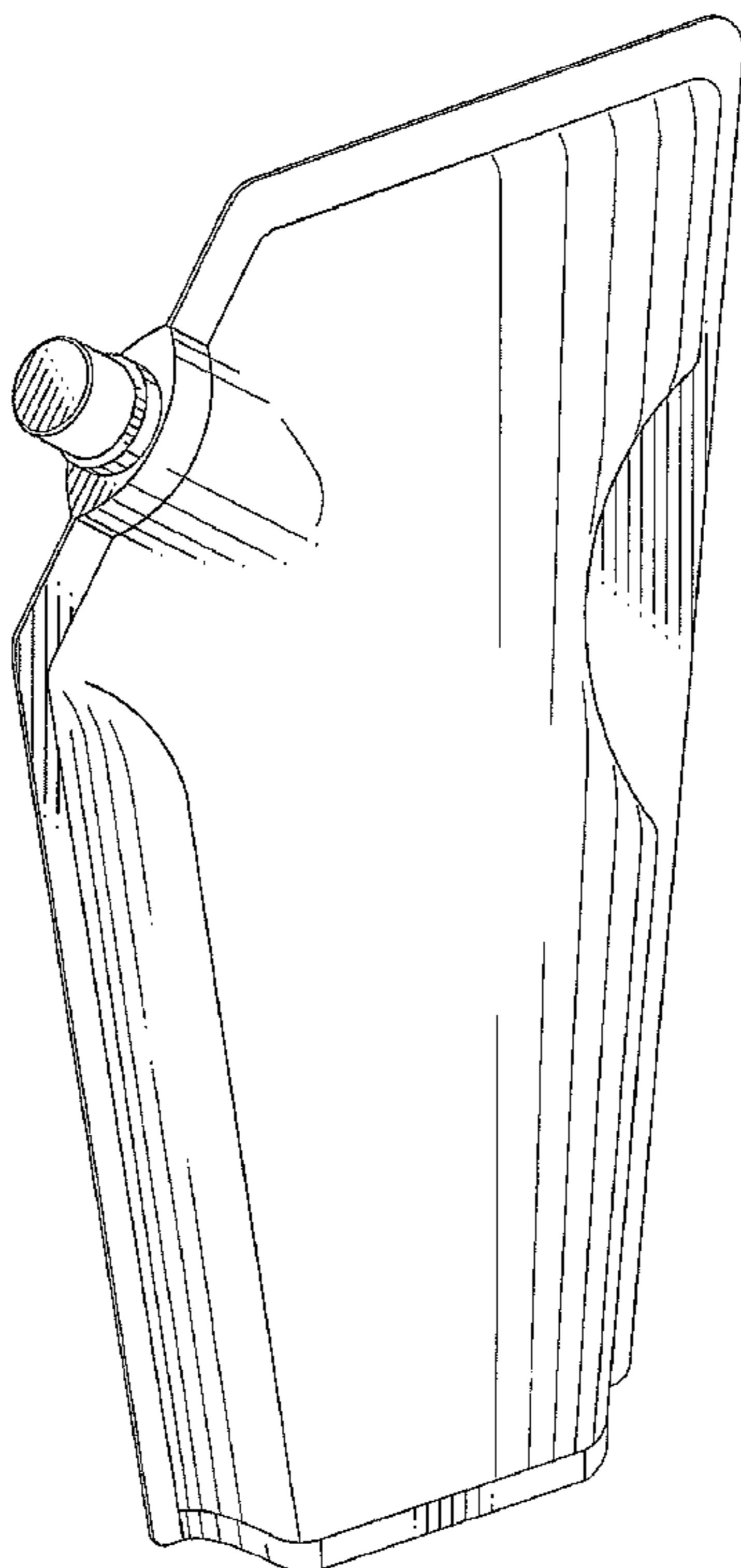

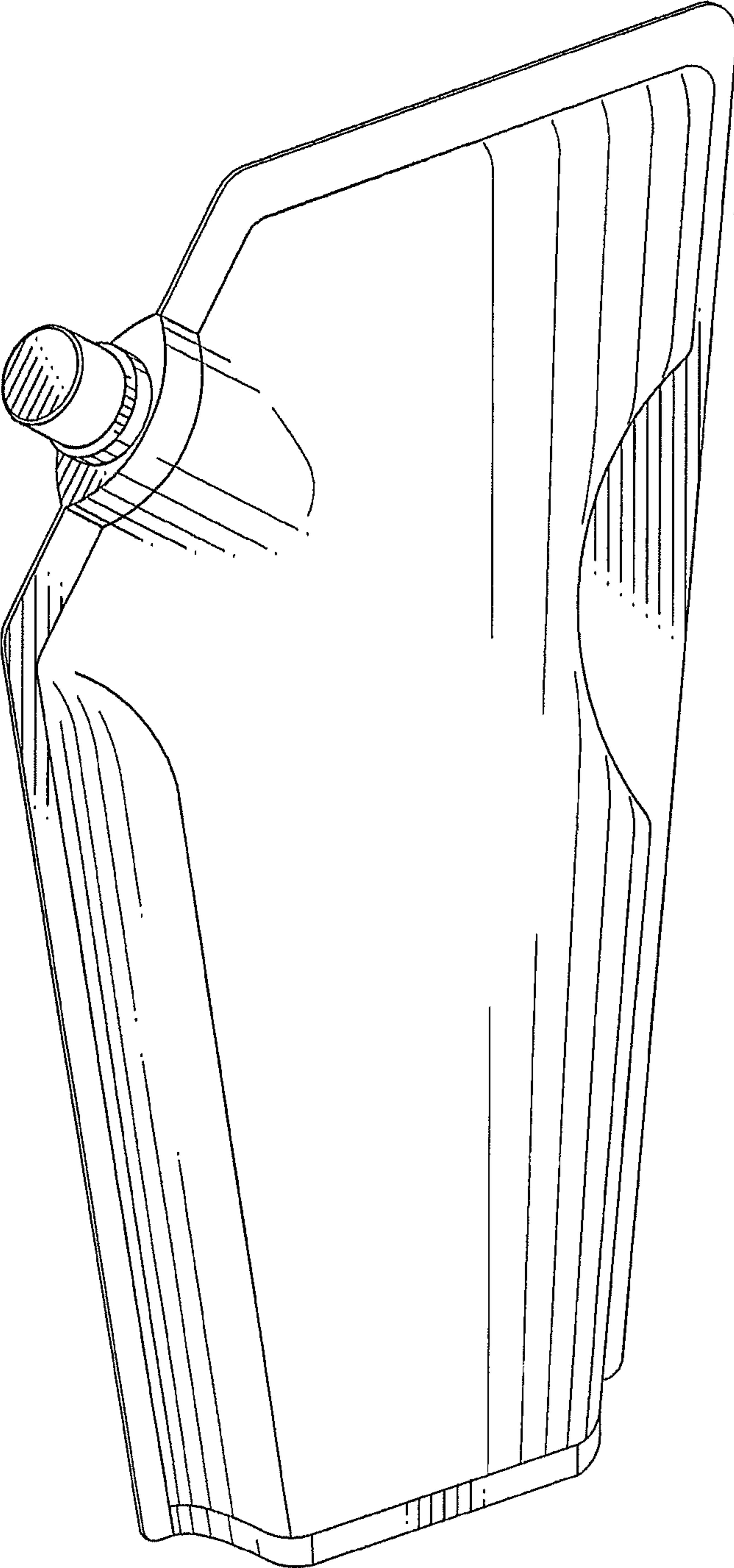

Fig. 1

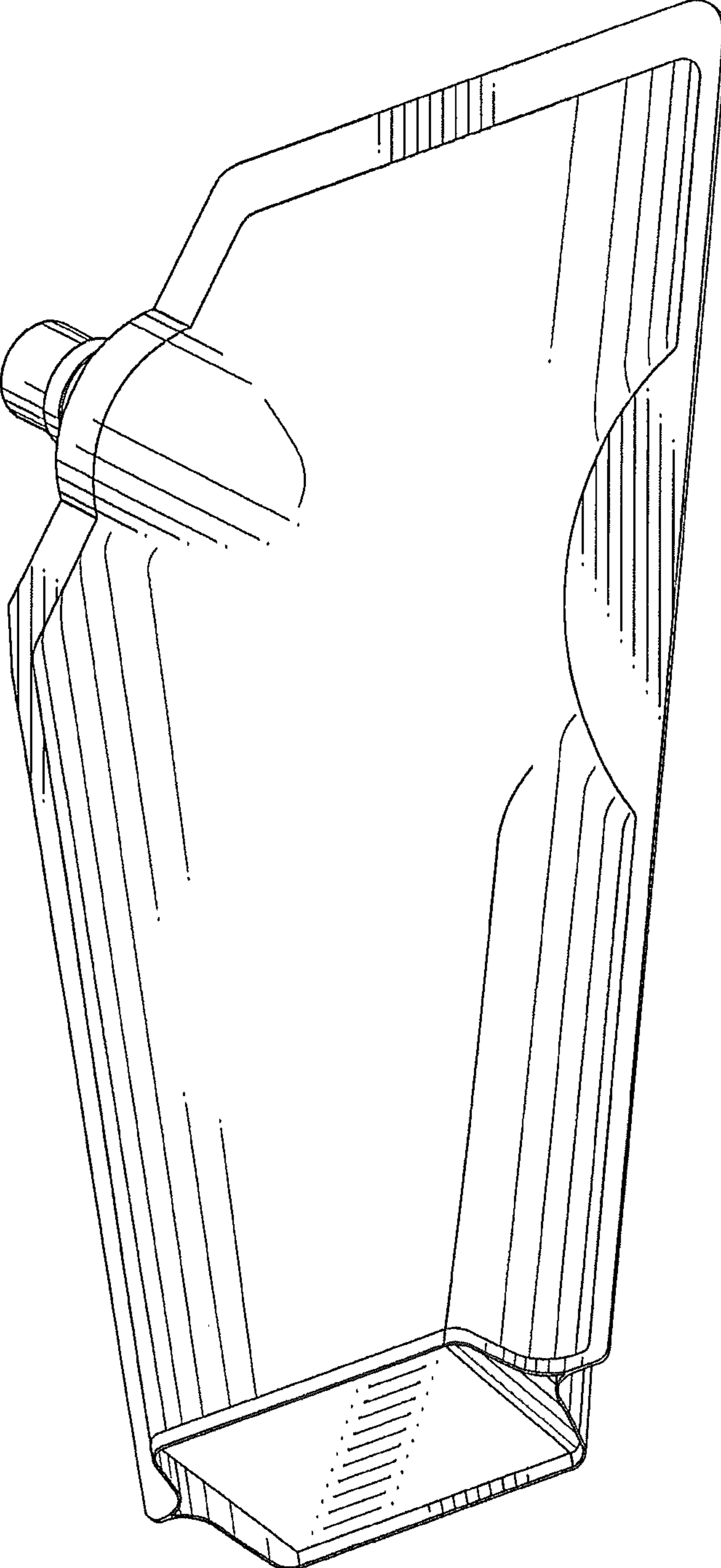

Fig.2

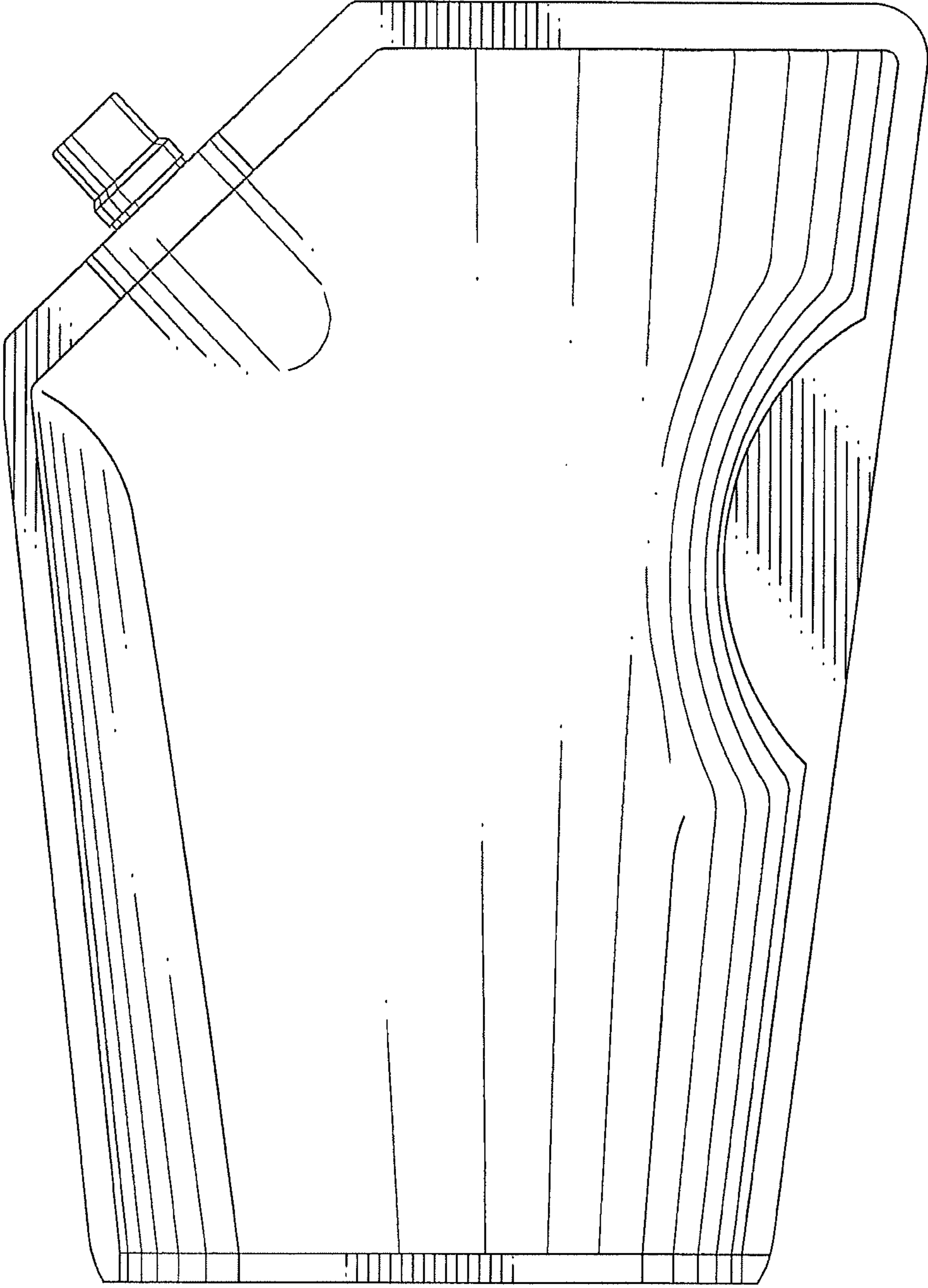

Fig.3

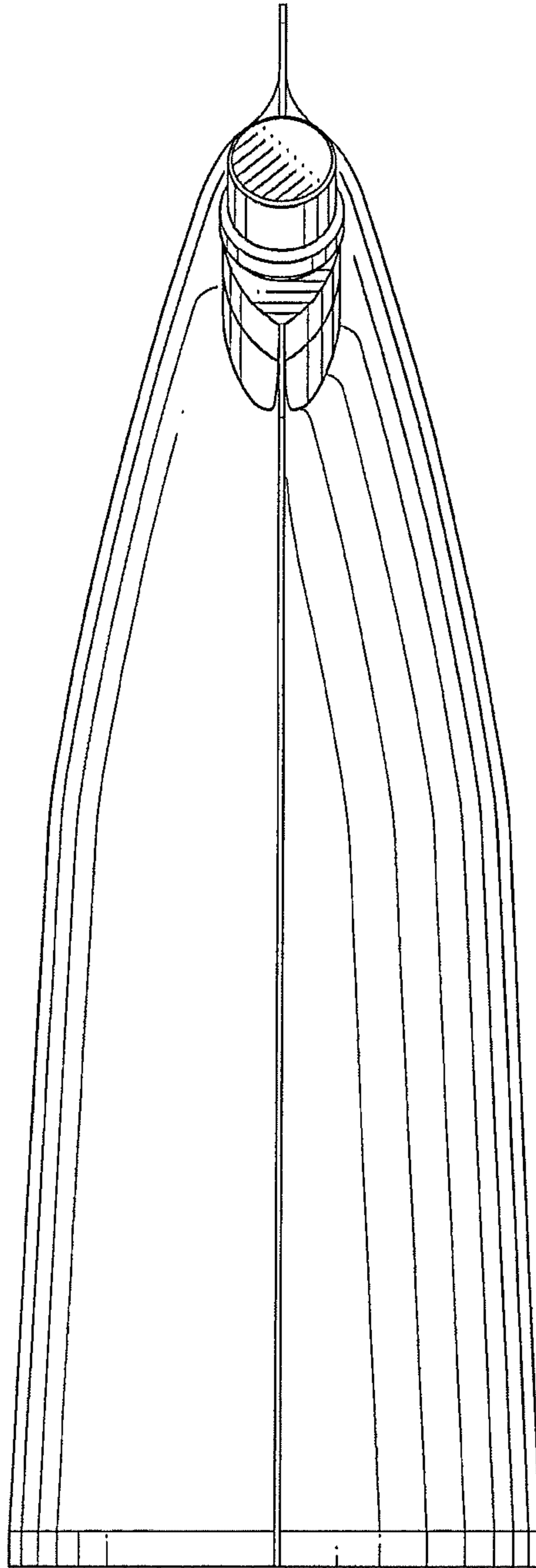

Fig.4

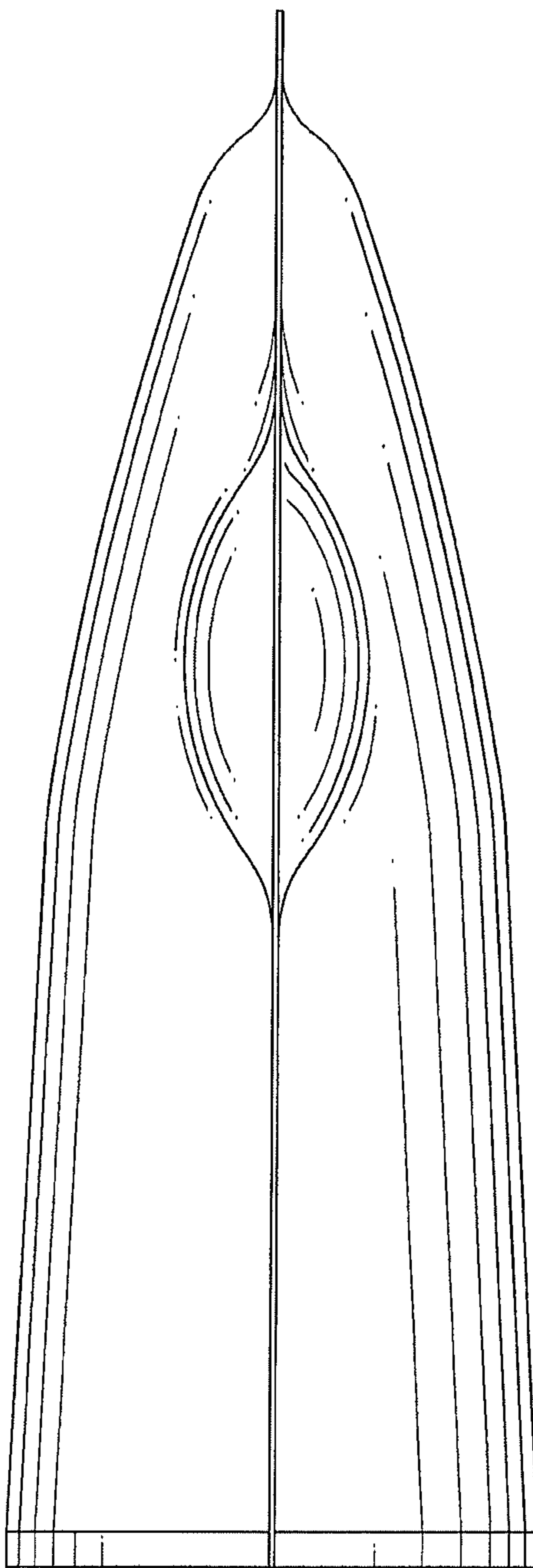

Fig.5

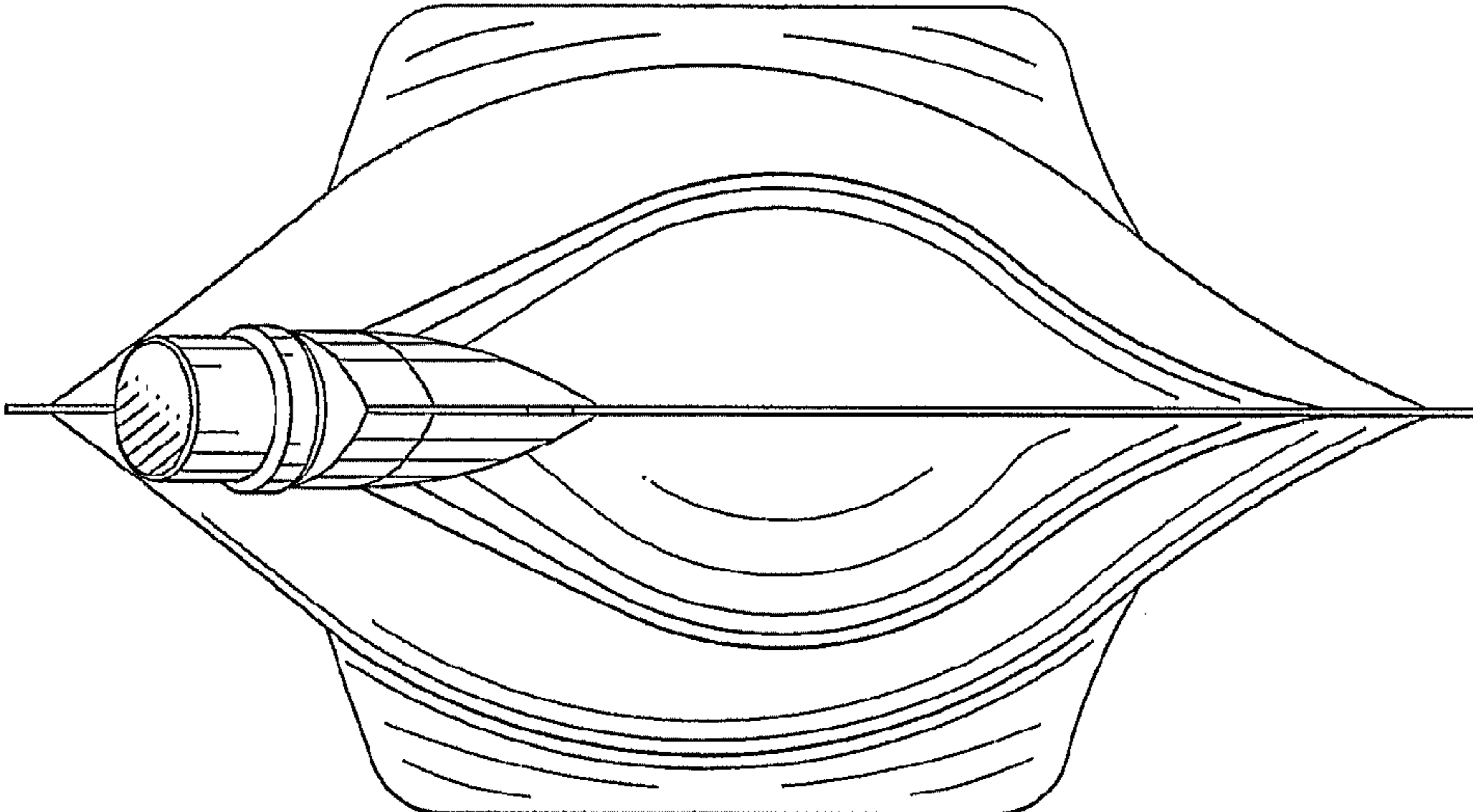

Fig. 6

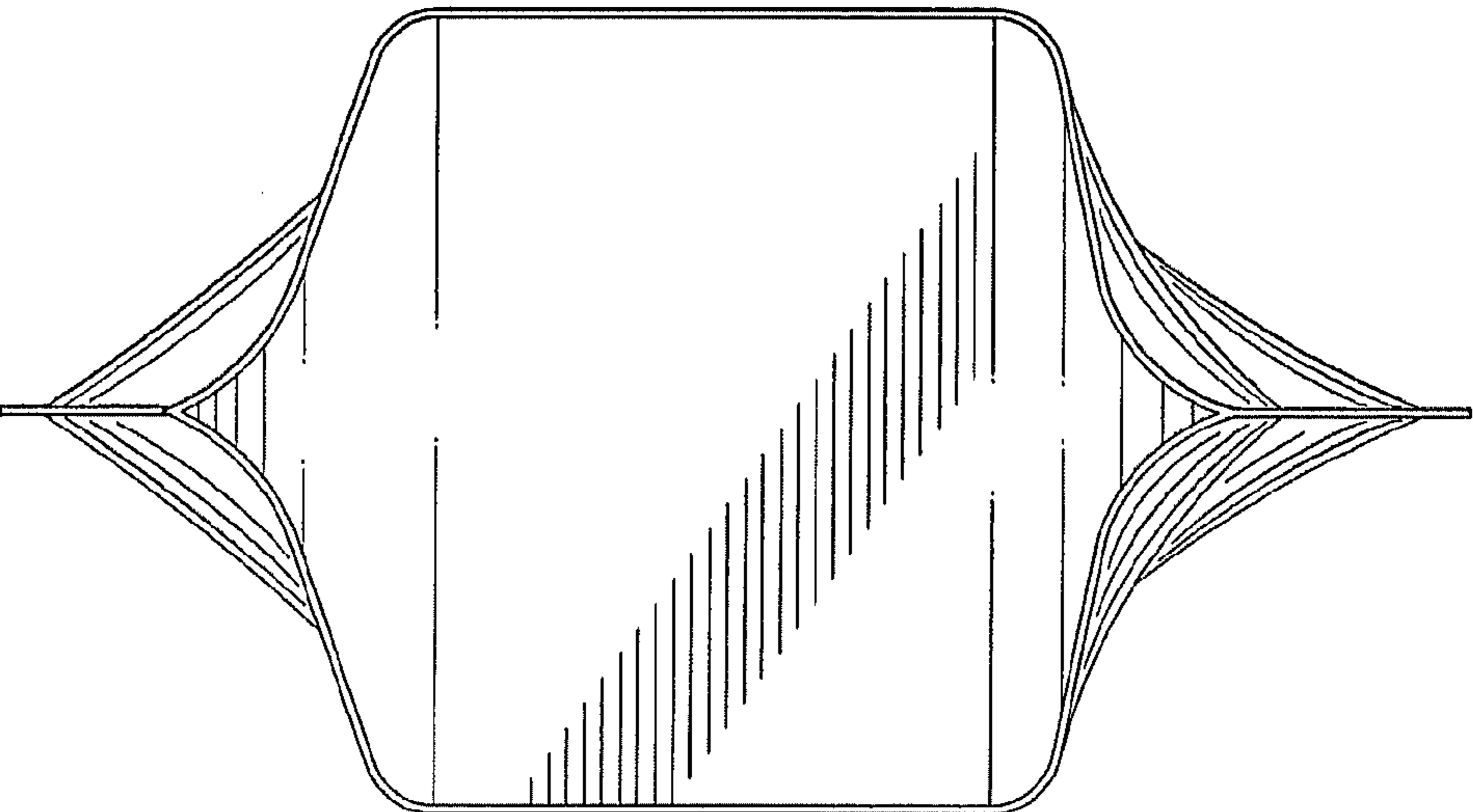

Fig. 7