



US00D688138S

(12) **United States Design Patent**
Kim

(10) **Patent No.:** US D688,138 S
(45) **Date of Patent:** ** Aug. 20, 2013

(54) **COSMETIC CONTAINER**

(75) **Inventor:** So Hee Kim, Seoul (KR)

(73) **Assignee:** Amorepacific Corporation, Seoul (KR)

(**) **Term:** 14 Years

(21) **Appl. No.:** 29/426,612

(22) **Filed:** Jul. 8, 2012

(30) **Foreign Application Priority Data**

Jan. 12, 2012 (KR) 30-2012-0001639

(51) **LOC (9) Cl.** **09-01**

(52) **U.S. Cl.**
USPC **D9/690; D9/691; D9/692**

(58) **Field of Classification Search**
USPC D9/500-505, 682-694, 600-681,
D9/516-575, 434-454, 719, 723-729;
222/153.01, 153.03, 153.04, 153.09,
222/153.11-153.14, 182, 631, 635, 321.7-321.9,
222/372, 373, 378, 379, 383.1, 384-386,
222/398, 400.7, 400.8, 401, 402.1-402.25;
215/379-384; 220/662, 665, 669-675; D19/36,
D19/41, 42, 46, 49; D4/114, 116; D28/7,
D28/76, 77, 85-91.1

See application file for complete search history.

(56) **References Cited**

U.S. PATENT DOCUMENTS

D150,004 S * 6/1948 Flaxman D28/87
2,964,045 A * 12/1960 Otto et al. 401/18
D191,487 S * 10/1961 Sagarin et al. D9/689
D201,473 S * 6/1965 Long D9/448
D214,048 S * 5/1969 Mason D23/223
D240,401 S * 7/1976 Armstrong D9/600

D241,918 S * 10/1976 Knickerbocker D9/448
D242,855 S * 12/1976 Grinberg D19/49
D267,982 S * 2/1983 Kennedy D28/5
D314,134 S * 1/1991 Litton et al. D9/692
5,242,089 A * 9/1993 Knickerbocker et al. ... 222/321.7
D376,910 S * 12/1996 Tuchman D4/114
D411,100 S * 6/1999 Torres D9/692
D463,973 S * 10/2002 Gobe D9/689
D464,564 S * 10/2002 Wilson et al. D9/556
D508,208 S * 8/2005 Ozaki et al. D9/688
6,948,639 B2 * 9/2005 Albisetti et al. 222/321.2
D515,421 S * 2/2006 Rossignol D9/448
D541,170 S * 4/2007 Bloc D9/692
D559,702 S * 1/2008 Althoff et al. D9/692
D645,750 S * 9/2011 Lee D9/504
D658,071 S * 4/2012 Lanz D9/600
D658,073 S * 4/2012 Lee D9/691

FOREIGN PATENT DOCUMENTS

EM 000117882-0001 * 3/2004
EM 000308291-0001 * 5/2005
KR 300440470.0000 * 2/2007

* cited by examiner

Primary Examiner — Catherine Tuttle

(74) *Attorney, Agent, or Firm* — Maxon IP LLC.; Justin H. Kim

(57) **CLAIM**

The ornamental design for a cosmetic container, as shown.

DESCRIPTION

FIG. 1 is a perspective view;
FIG. 2 is a front view thereof;
FIG. 3 is a rear view thereof;
FIG. 4 is a left side view thereof;
FIG. 5 is a right side view thereof;
FIG. 6 is a top view thereof; and,
FIG. 7 is an exploded view thereof.

1 Claim, 7 Drawing Sheets

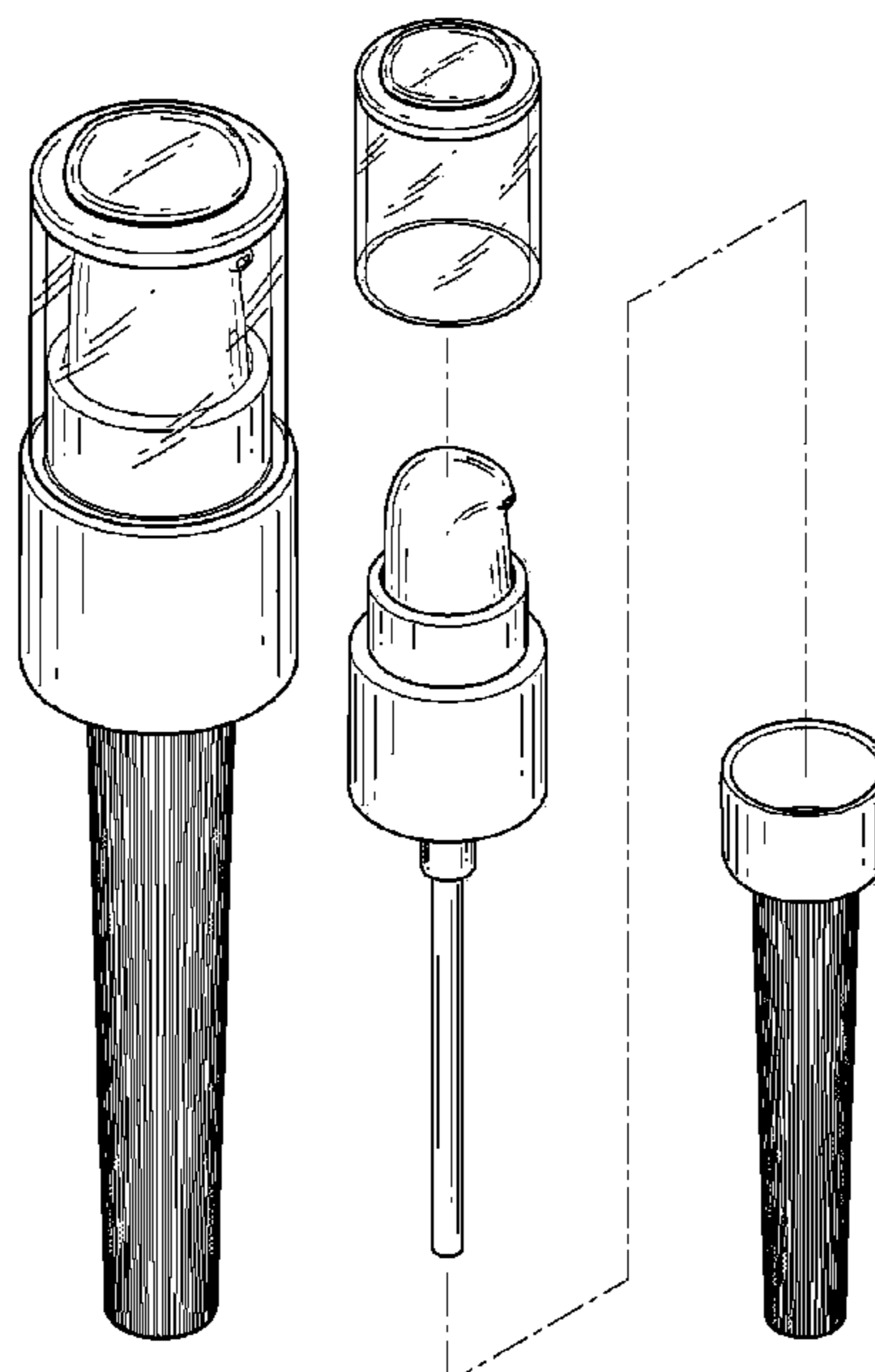

FIG. 1

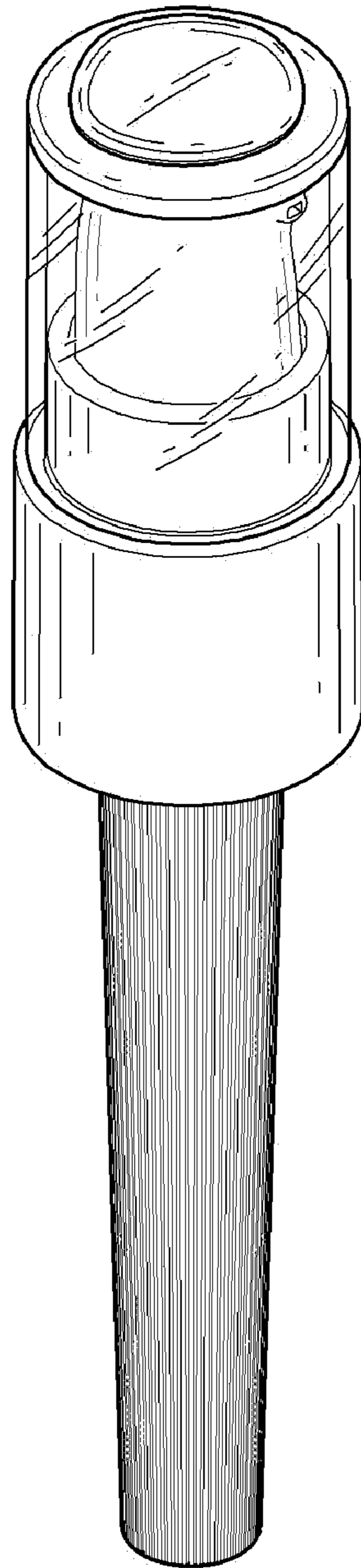

FIG. 2

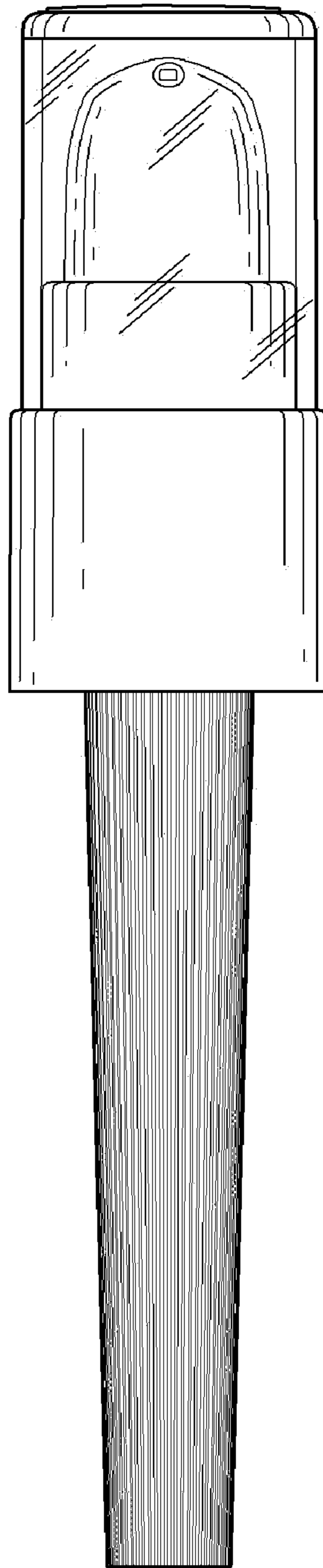

FIG. 3

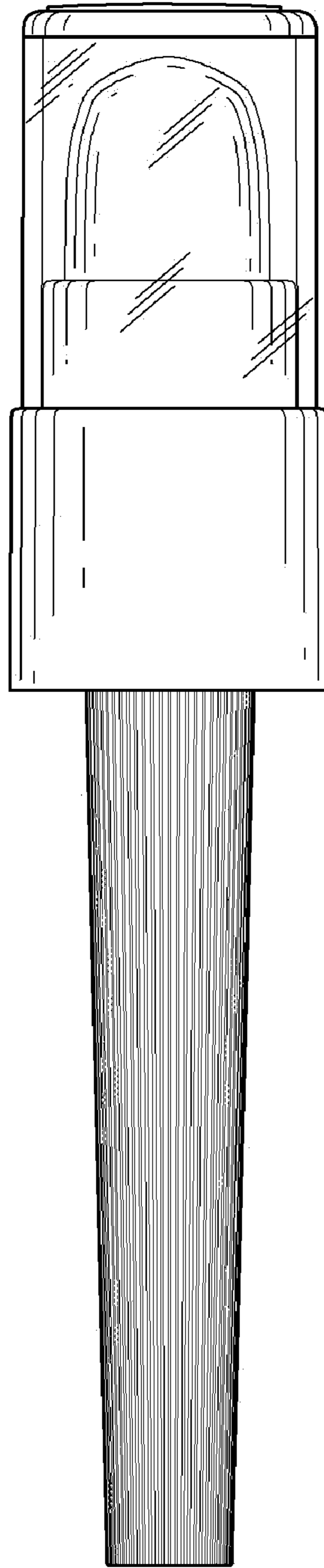

FIG. 4

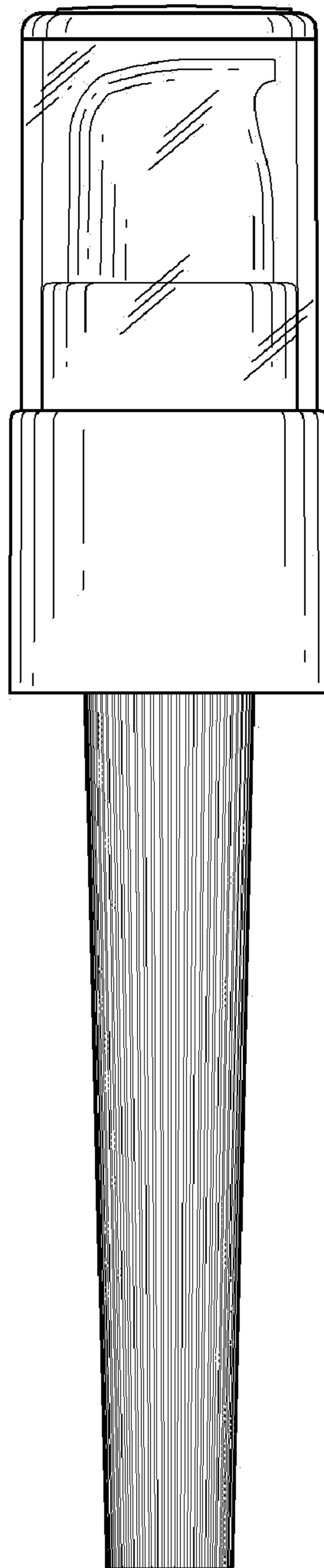

FIG. 5

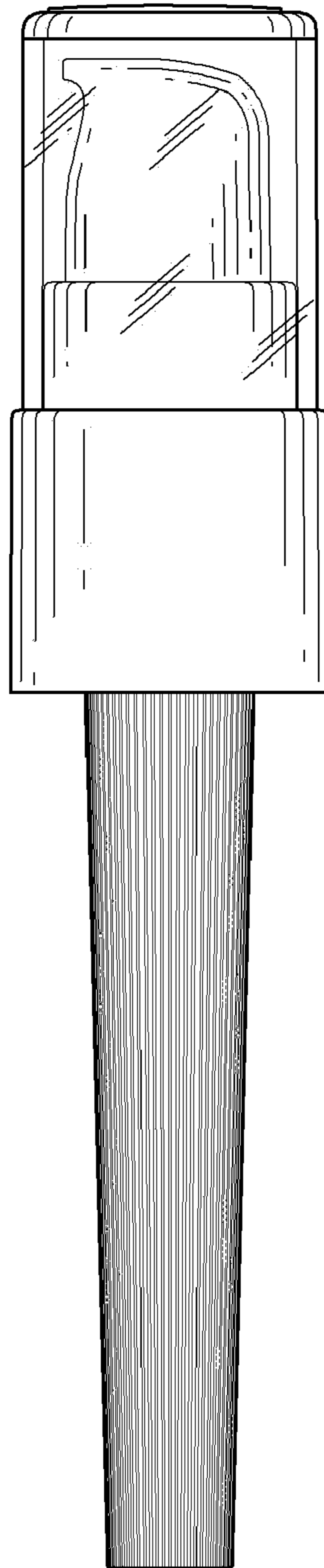

FIG. 6

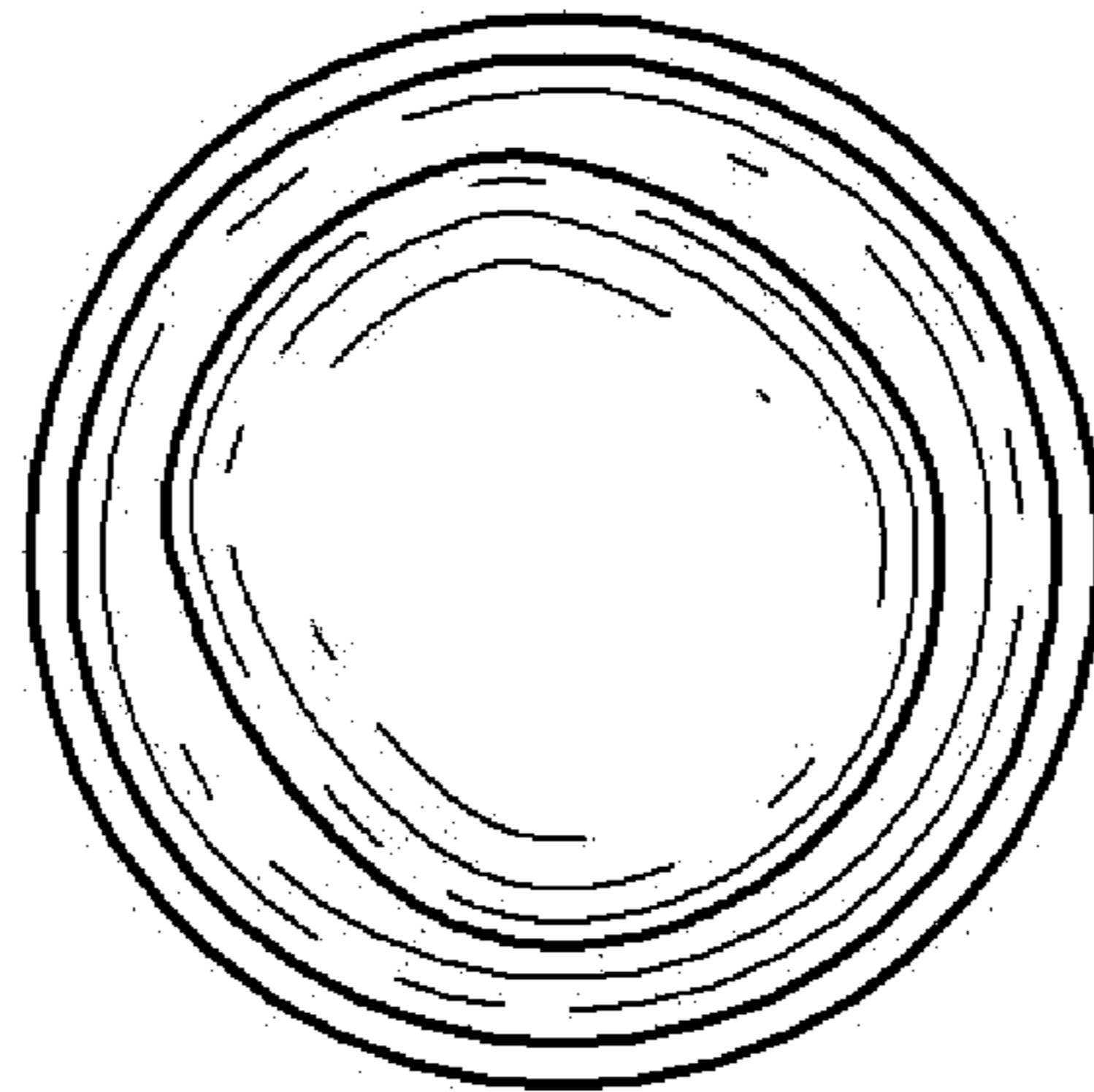

FIG. 7

