



US00D688026S

(12) **United States Design Patent**
Vaughn

(10) **Patent No.:** **US D688,026 S**

(45) **Date of Patent:** **** Aug. 20, 2013**

(54) **PACKAGED FOOD ARTICLE**

(76) Inventor: **Chad E. Vaughn**, Owings Mills, MD
(US)

(**) Term: **14 Years**

(21) Appl. No.: **29/431,307**

(22) Filed: **Sep. 6, 2012**

(51) **LOC (9) Cl.** **01-01**

(52) **U.S. Cl.**
USPC **D1/102**

(58) **Field of Classification Search**

USPC D1/100–130, 199; 426/104, 115,
426/121, 129, 130, 144, 249, 274, 303, 414,
426/420; D6/597, 407, 632; D7/507, 675;
220/574, 4.24; 29/428; D9/669, 435, 707,
D9/414, 415, 418; D21/443; 446/46, 47,
446/48; 229/123.1; D24/216; 206/273,
206/467

See application file for complete search history.

(56) **References Cited**

U.S. PATENT DOCUMENTS

3,391,847	A *	7/1968	Christine et al.	229/123.1
D219,644	S *	1/1971	Arcudi	D9/707
3,948,523	A *	4/1976	Michael	473/588
4,209,126	A *	6/1980	Elias	229/123.2
4,438,850	A *	3/1984	Kahn	229/123.1
D276,218	S *	11/1984	Baldwin et al.	D9/499
D282,616	S *	2/1986	Gallagher et al.	D7/392.1
D337,944	S *	8/1993	Ward-Weber	D9/438
D343,548	S *	1/1994	Helfer	D7/387
D365,024	S *	12/1995	DuBow	D9/434
D369,191	S *	4/1996	Dunipace	D21/443
D371,958	S *	7/1996	Keaton	D8/374
D397,375	S *	8/1998	Fletcher et al.	D21/386
D415,652	S *	10/1999	Loew et al.	D7/392.1

(Continued)

Primary Examiner — Cathron Brooks

Assistant Examiner — Katie Mroczka

(74) *Attorney, Agent, or Firm* — Ober, Kaler, Grimes & Shriver; Royal W. Craig

(57) **CLAIM**

The ornamental design for a packaged food article, as shown and described.

DESCRIPTION

FIG. 1 is a top perspective view of the packaged food article according to a preferred embodiment of my new design.

FIG. 2 is a left side view of the packaged food article as in FIG. 1.

FIG. 3 is a right side view of the packaged food article as in FIGS. 1-2,

FIG. 4 is a top view of the packaged food article as in FIGS. 1-3.

FIG. 5 is a bottom view of the packaged food article as in FIGS. 1-4.

FIG. 6 is a bottom perspective view of the packaged food article as in FIGS. 1-5 with package dosed.

FIG. 7 is a top perspective view of the packaged food article as in FIGS. 1-6 with package partially open to expose the food article.

FIG. 8 is a top perspective view of an alternate embodiment of the packaged food article.

FIG. 9 is a left side view of the packaged food article as in FIG. 8.

FIG. 10 is a right side view of the packaged food article as in FIGS. 8-9,

FIG. 11 is a top view of the packaged food article as in FIGS. 8-10.

FIG. 12 is a bottom view of the packaged food article as in FIGS. 8-11.

FIG. 13 is a bottom perspective view of the packaged food article as in FIGS. 8-12 with package closed; and,

FIG. 14 is a top perspective view of the packaged food article as in FIGS. 8-13 with package partially open to expose the food article.

The design of the present invention and as shown in FIGS. 1-14 is a packaged food article having an ornamental annular appearance.

1 Claim, 6 Drawing Sheets

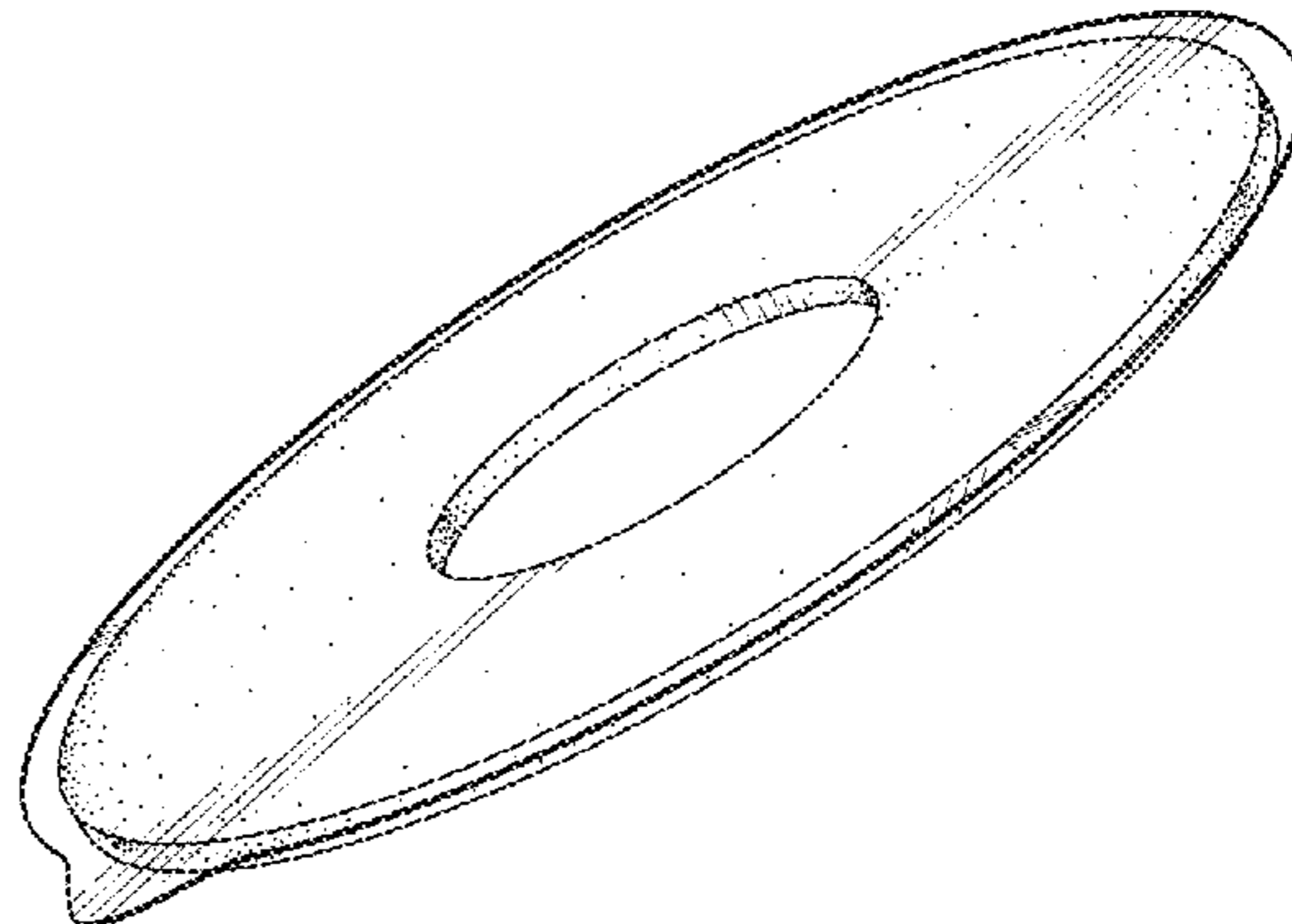
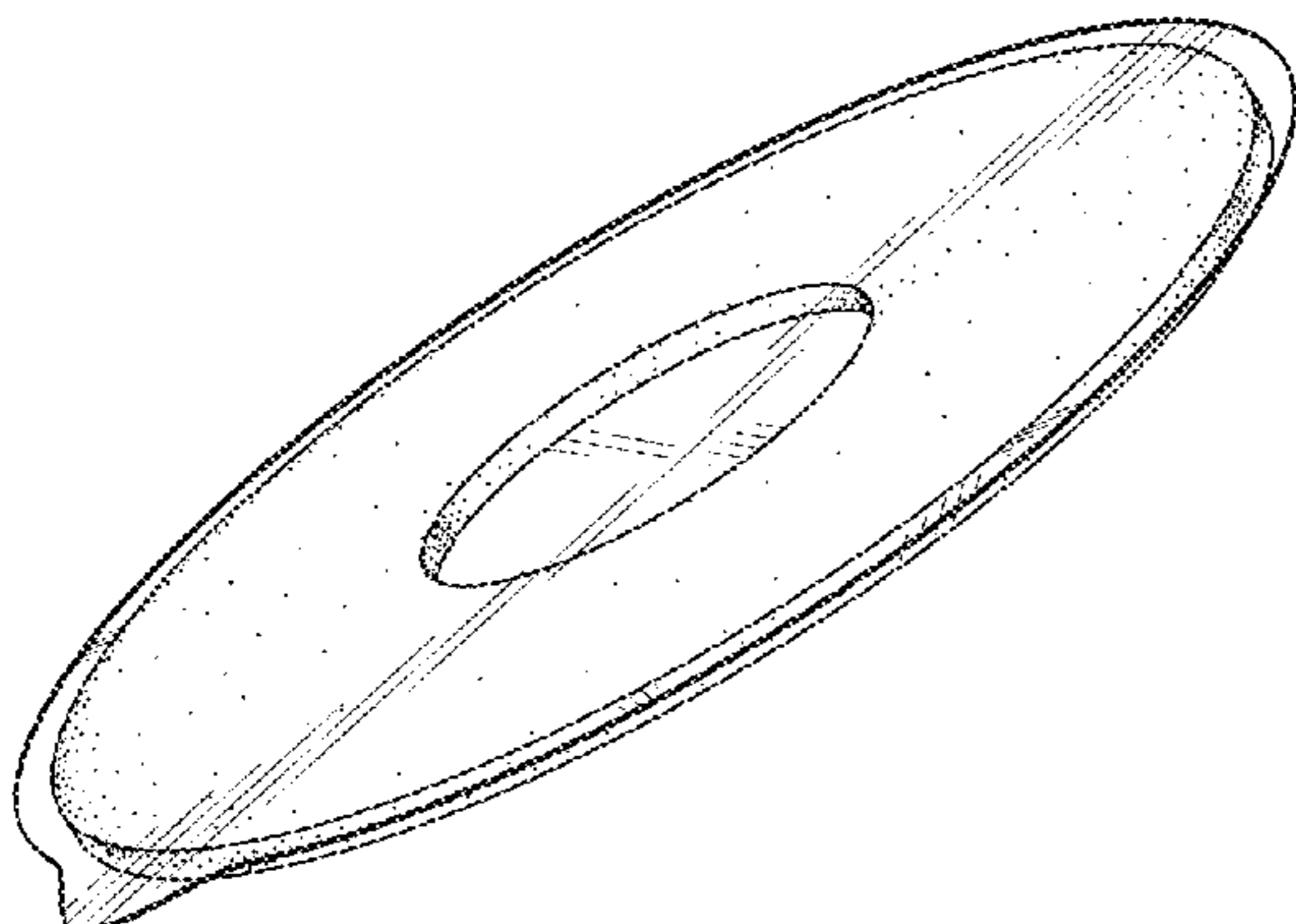

(56)

References Cited

U.S. PATENT DOCUMENTS

D417,817 S * 12/1999 Loew et al. D7/392.1
6,135,455 A * 10/2000 McNally 273/338
D445,687 S * 7/2001 Gilbertson D9/454
D447,614 S * 9/2001 Wolff D1/127
6,427,832 B1 * 8/2002 Ali et al. 206/303

D540,006 S * 4/2007 Green et al. D1/105
D564,576 S * 3/2008 Larsen D17/20
D642,055 S * 7/2011 Schedl et al. D9/435
D653,107 S * 1/2012 Margan D9/434
D668,308 S * 10/2012 Gilmore et al. D21/803
D672,050 S * 12/2012 Lee et al. D24/216

* cited by examiner

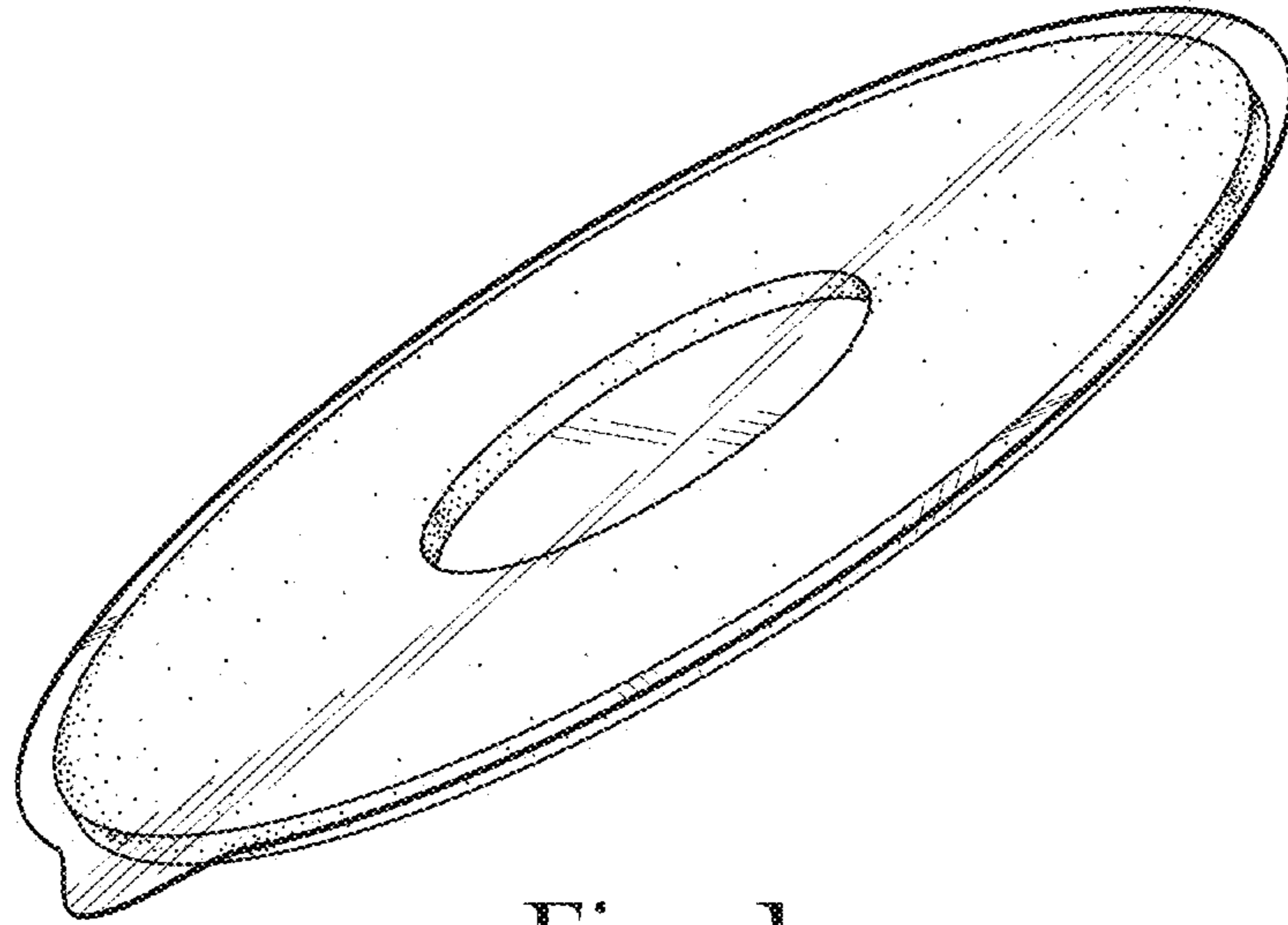

Fig. 1

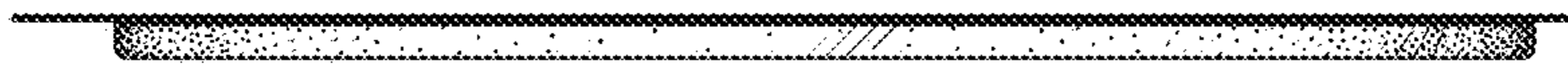

Fig. 2

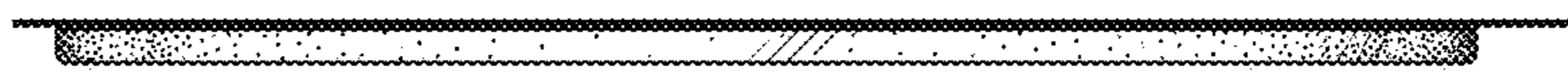

Fig. 3

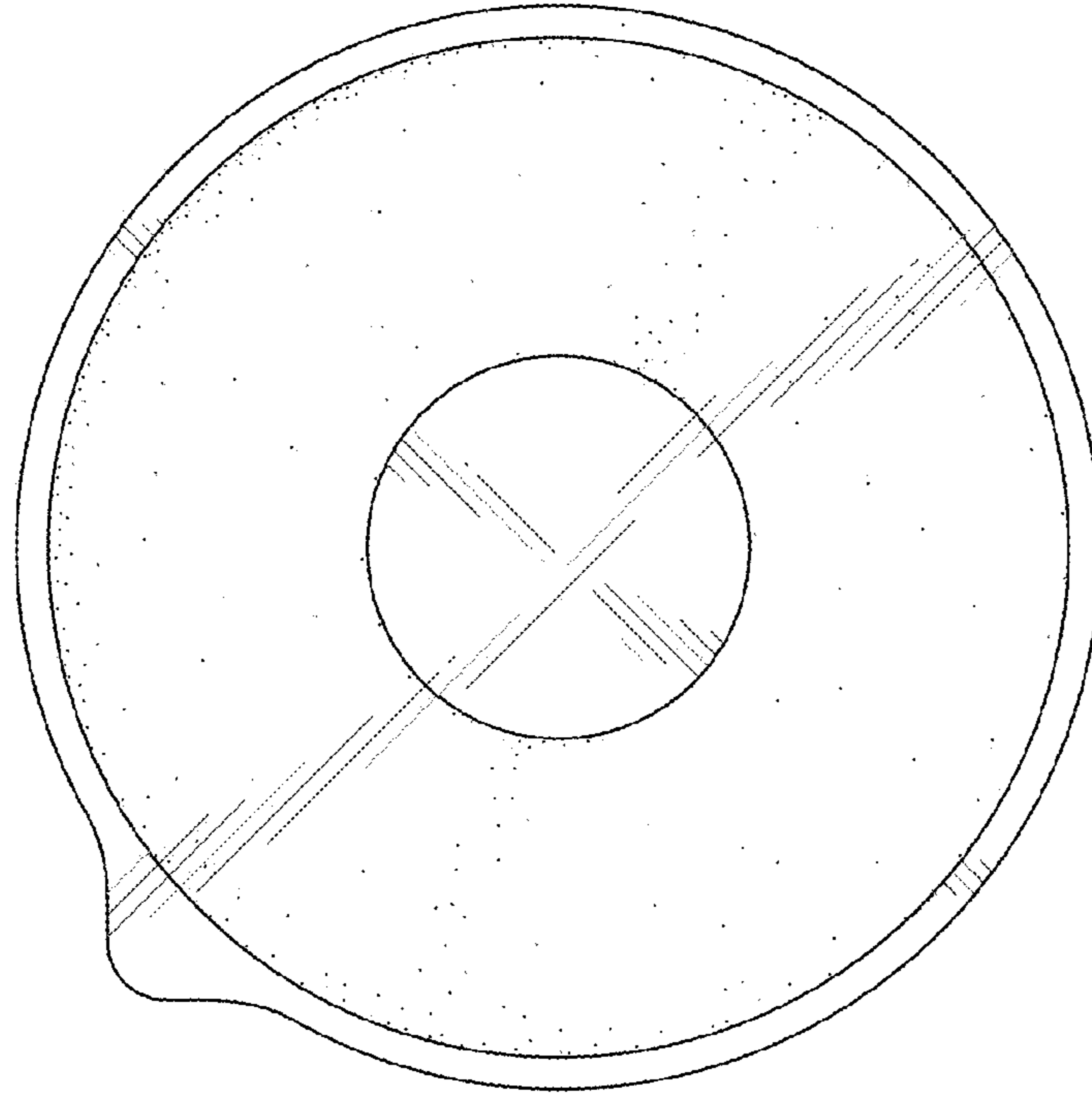

Fig. 4

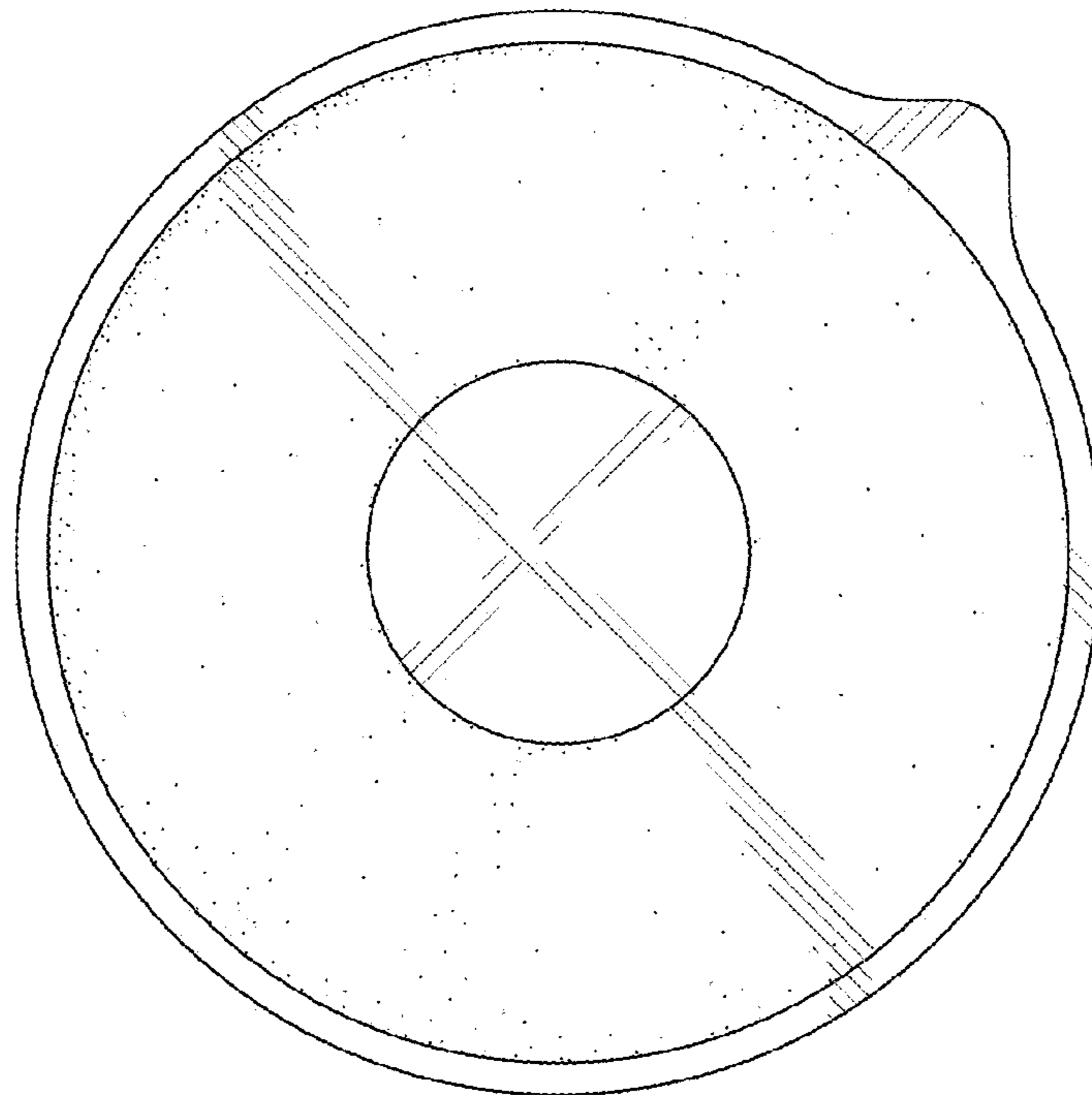

Fig. 5

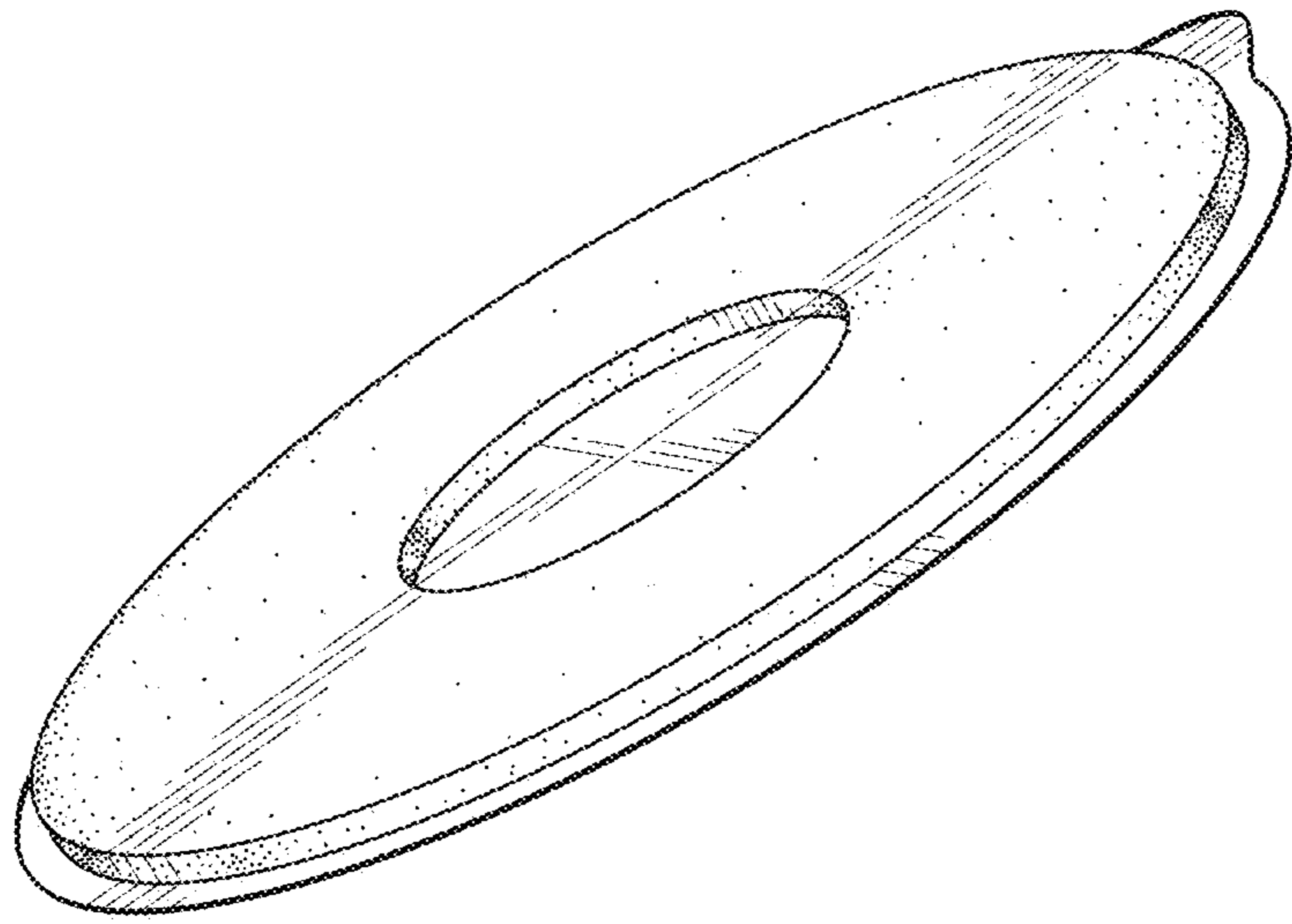

Fig. 6

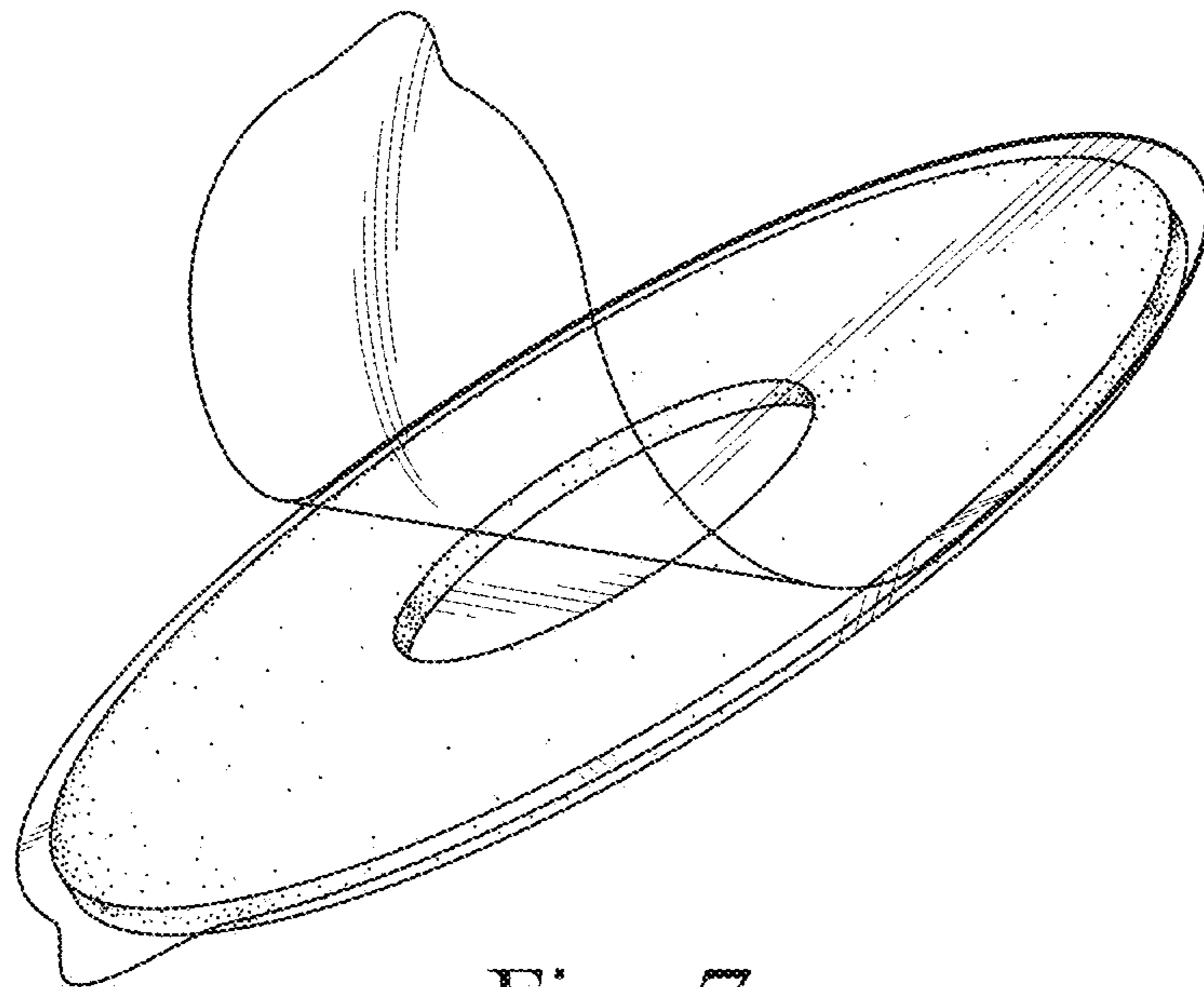

Fig. 7

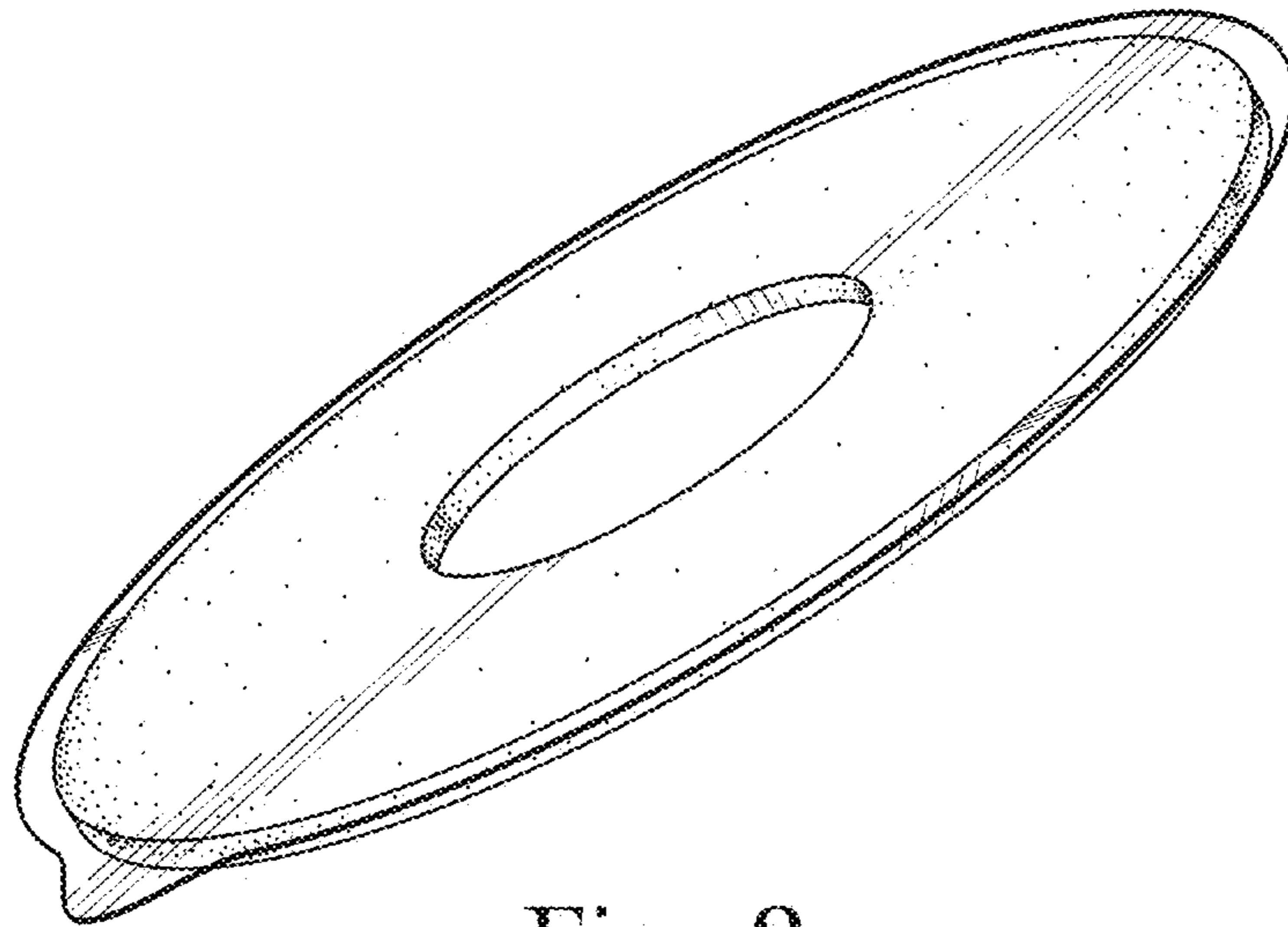

Fig. 8

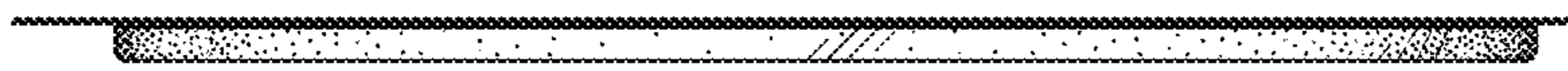

Fig. 9



Fig. 10

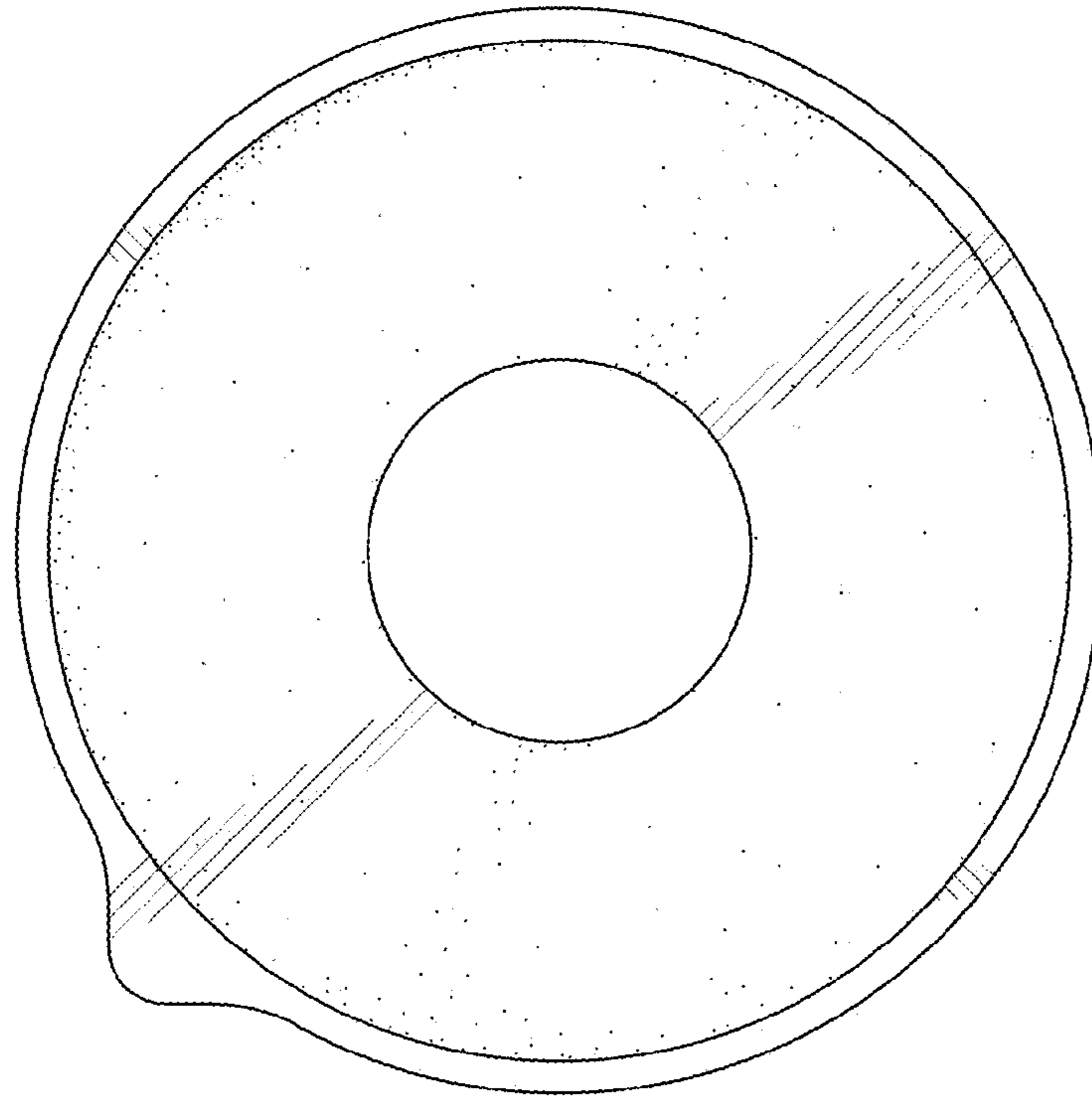

Fig. 11

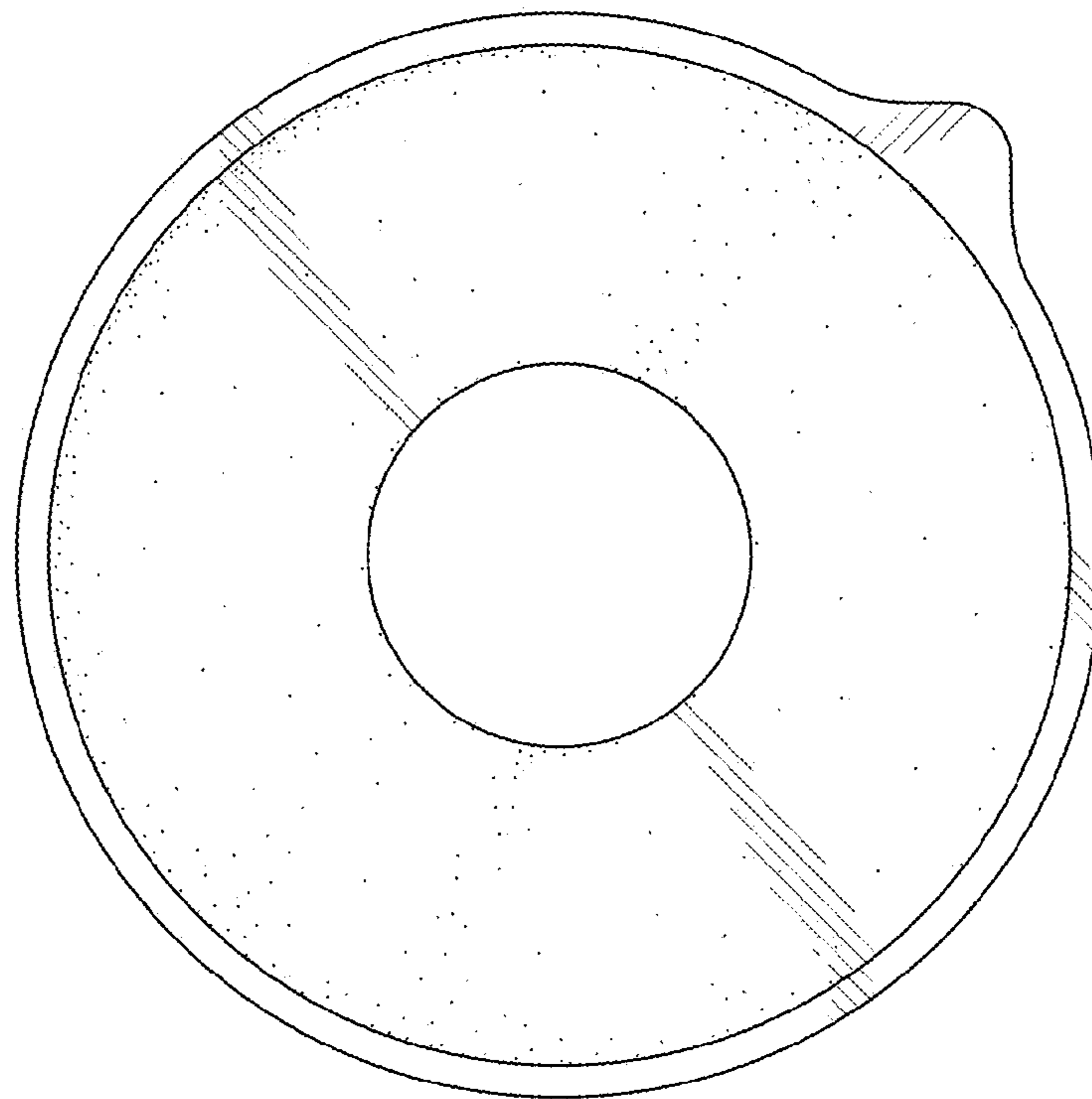

Fig. 12

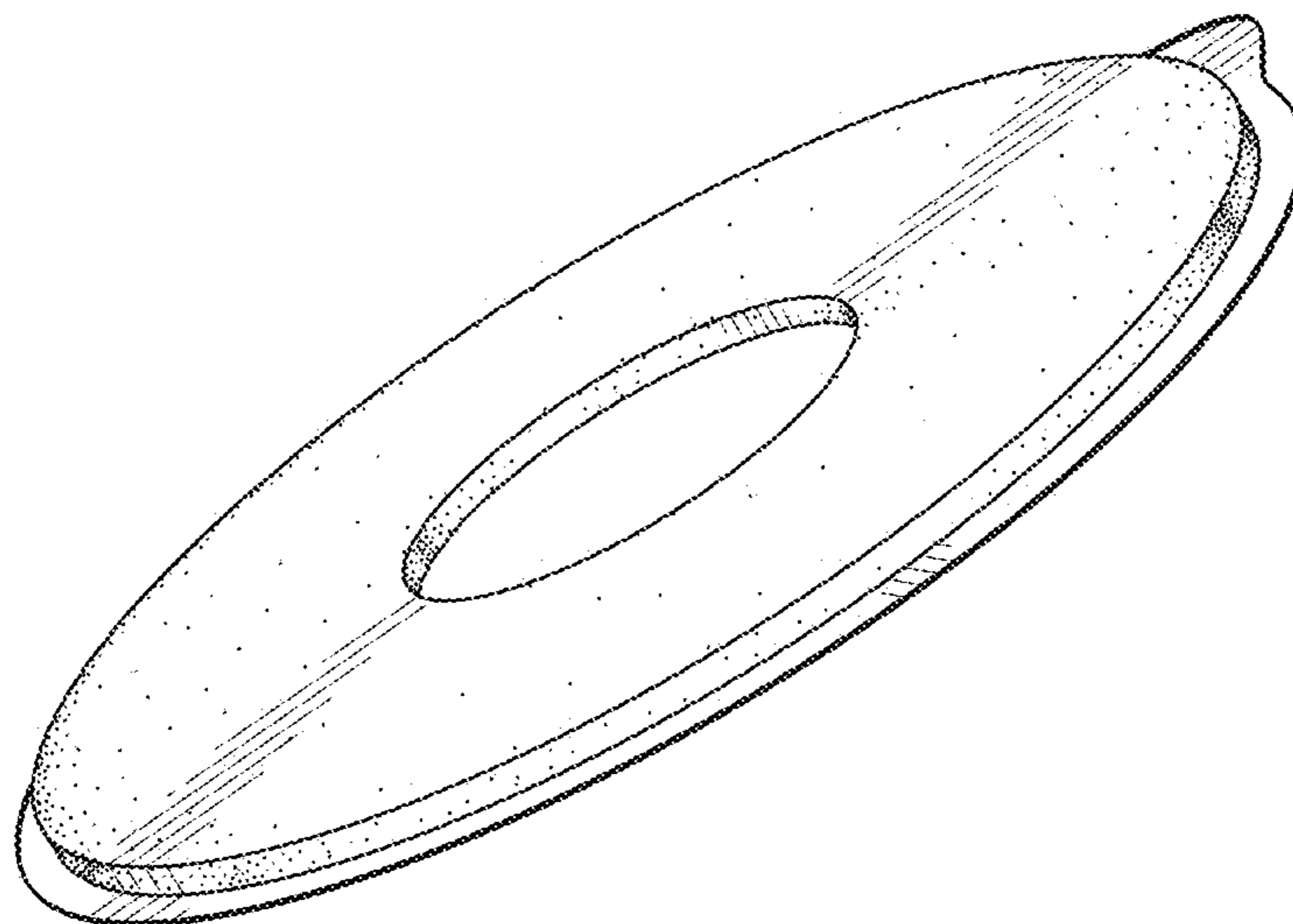

Fig. 13

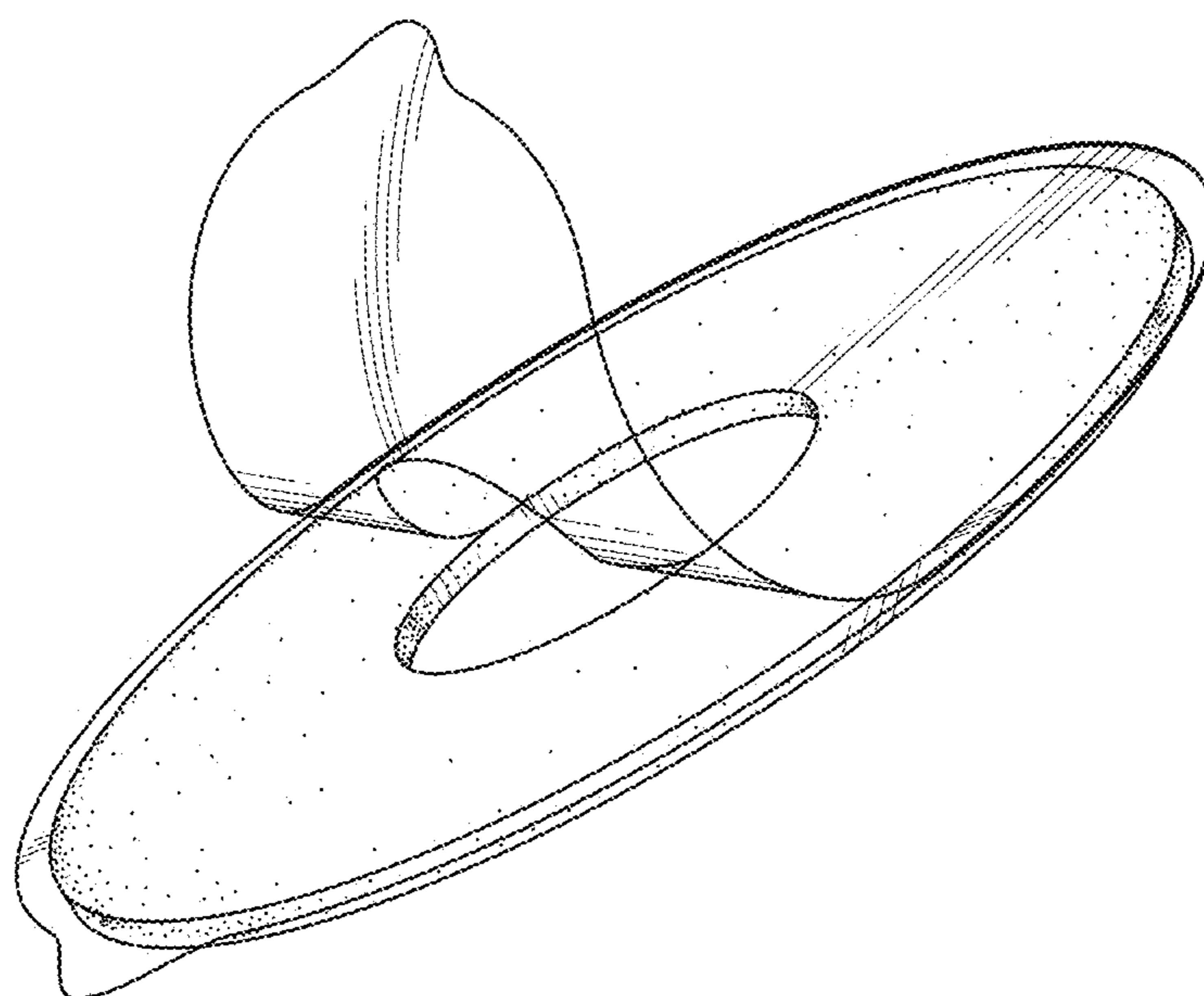

Fig. 14