



US00D688013S

(12) **United States Design Patent**
Kim et al.

(10) **Patent No.:** **US D688,013 S**

(45) **Date of Patent:** **** Aug. 13, 2013**

(54) **WASHING MACHINE**

(75) Inventors: **Jinnam Kim**, Suwon-si (KR); **Dae Kyun Lee**, Seoul (KR); **Jaewon Choi**, Seoul (KR)

(73) Assignee: **Samsung Electronics Co, Ltd.**, Gyeonggi-do (KR)

(**) Term: **14 Years**

(21) Appl. No.: **29/413,603**

(22) Filed: **Feb. 17, 2012**

(51) **LOC (9) Cl.** **15-05**

(52) **U.S. Cl.**
USPC **D32/6**

(58) **Field of Classification Search**
USPC D32/1, 5, 6, 8, 10; 68/3 R, 4, 5 R,
68/12.01, 12.07, 12.08, 212;
34/87-88, 523-524

See application file for complete search history.

(56) **References Cited**

U.S. PATENT DOCUMENTS

D557,465 S *	12/2007	Kim et al.	D32/6
D582,105 S *	12/2008	Cho et al.	D32/6
D618,863 S *	6/2010	Jeon et al.	D32/6
D618,864 S *	6/2010	Jeon et al.	D32/6
D622,917 S *	8/2010	Lee	D32/6
D625,889 S *	10/2010	Lee et al.	D32/6
D628,755 S *	12/2010	Helot et al.	D32/5

D631,624 S *	1/2011	Chung et al.	D32/6
D635,727 S *	4/2011	Jeon et al.	D32/6
D636,953 S *	4/2011	Lee	D32/6
D665,543 S *	8/2012	Kim et al.	D32/6

* cited by examiner

Primary Examiner — T. Chase Nelson
Assistant Examiner — Kathleen M Sims

(74) *Attorney, Agent, or Firm* — Harness, Dickey & Pierce, P.L.C.

(57) **CLAIM**

We claim the ornamental design for a washing machine, as shown and described.

DESCRIPTION

FIG. 1 is a front/right-side/top perspective view of a washing machine showing our new design;
FIG. 2 is a front elevational view thereof;
FIG. 3 is a rear elevational view thereof;
FIG. 4 is a left-side elevational view thereof;
FIG. 5 is a right-side elevational view thereof;
FIG. 6 is a top plan view thereof; and,
FIG. 7 is a bottom plan view thereof.
The broken line showing of rear and front details is included for the purpose of illustrating environmental portions of the washing machine and forms no part of the claimed design.

1 Claim, 7 Drawing Sheets

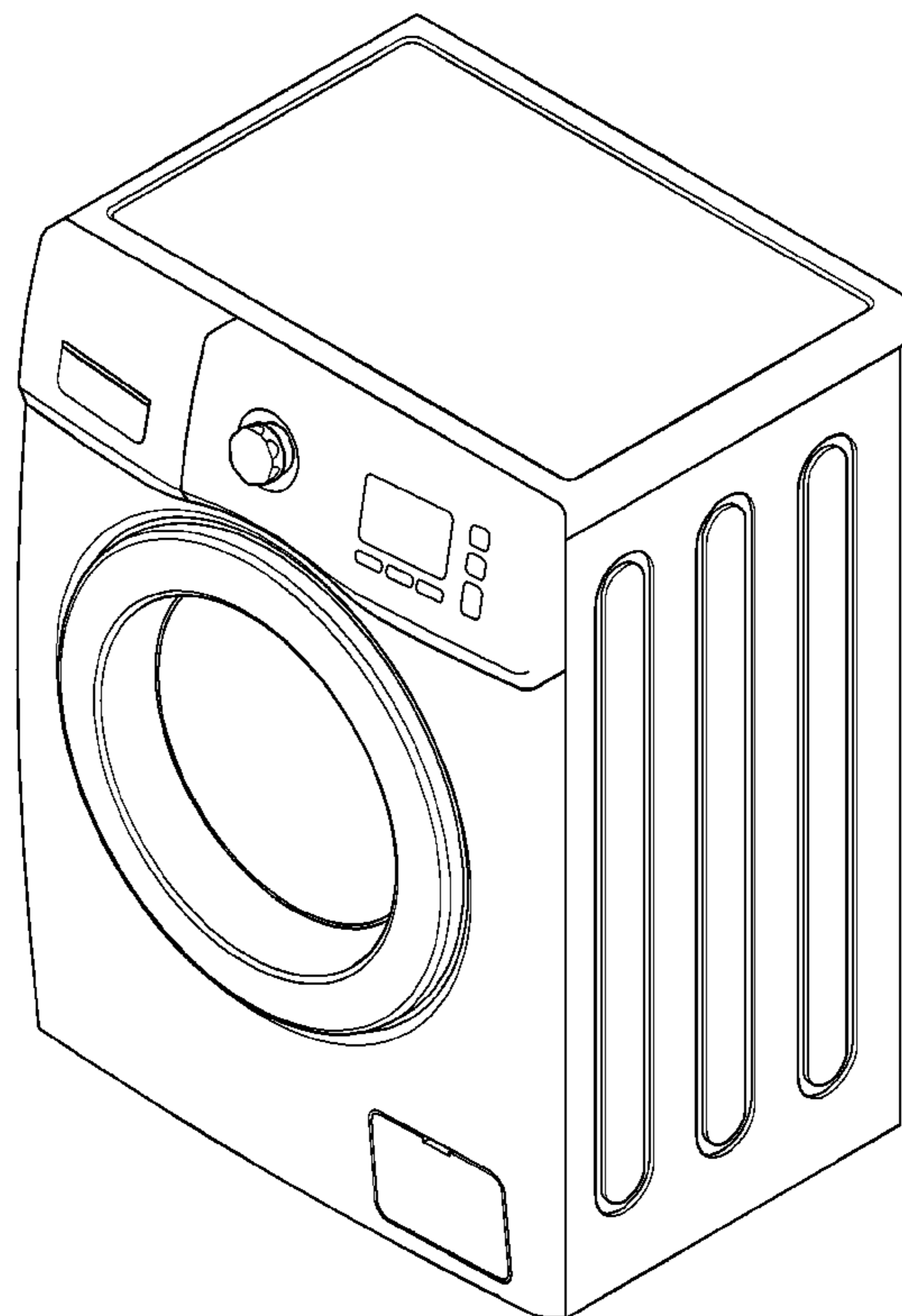

FIG. 1

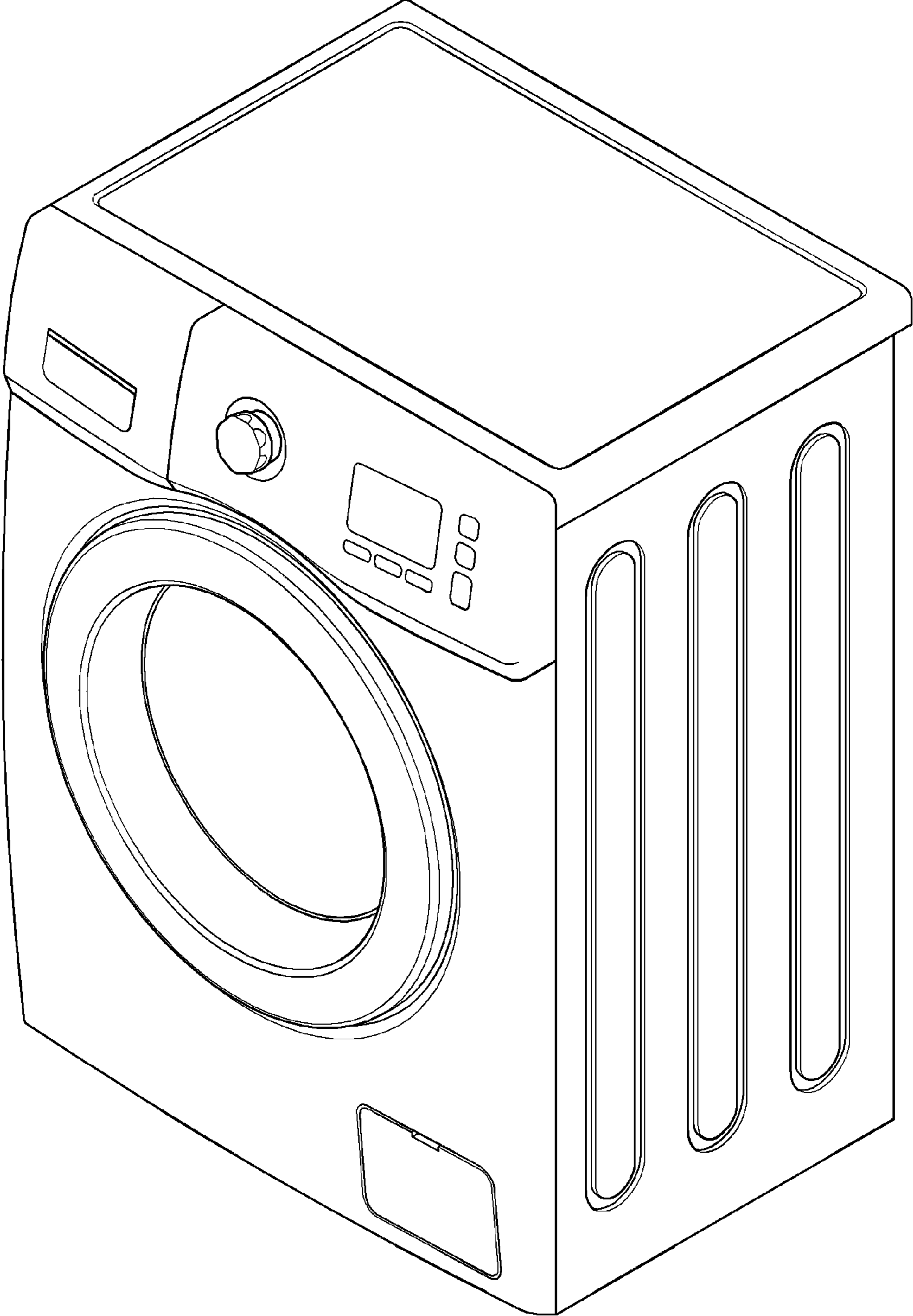

FIG. 2

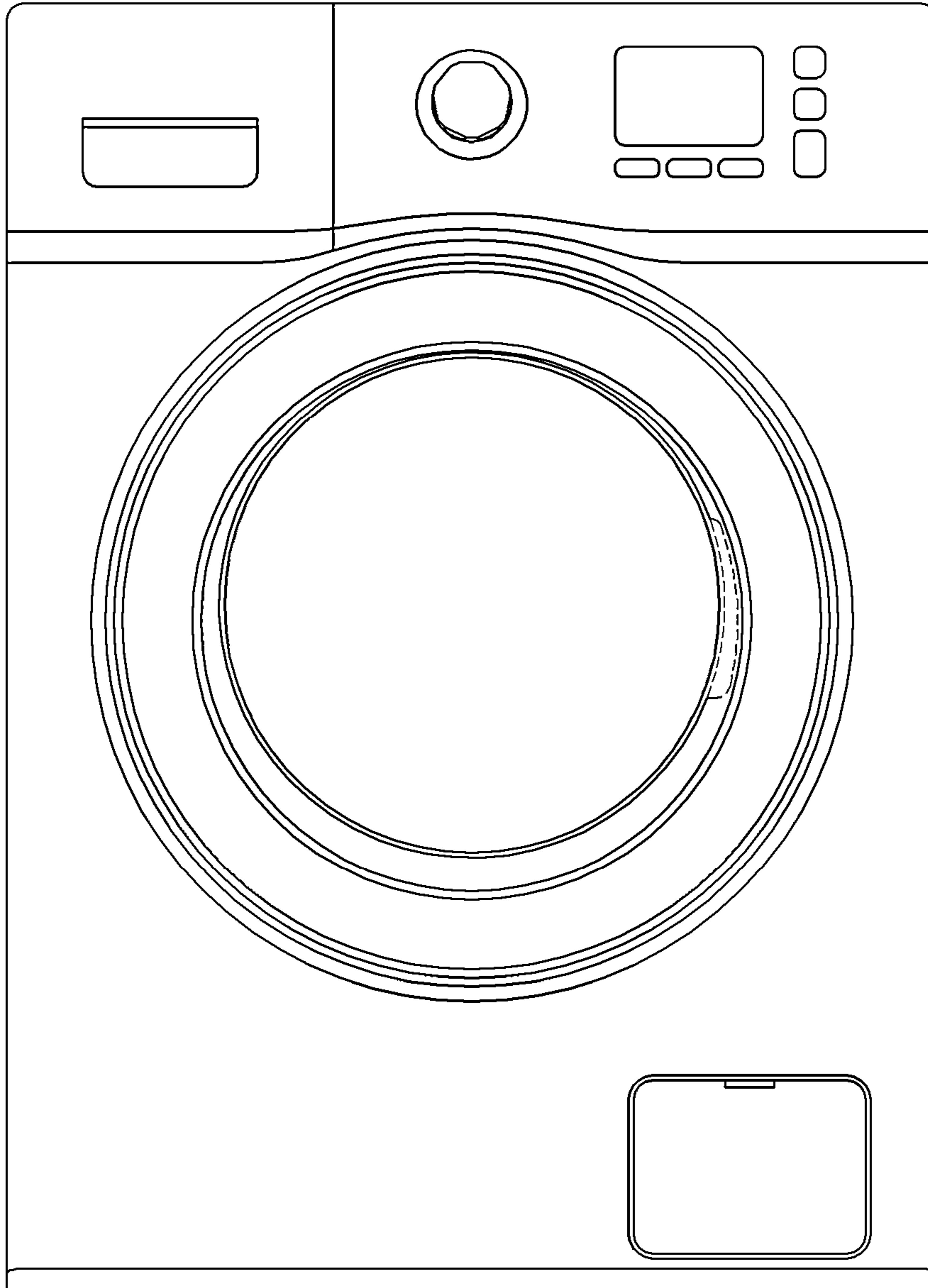

FIG. 3

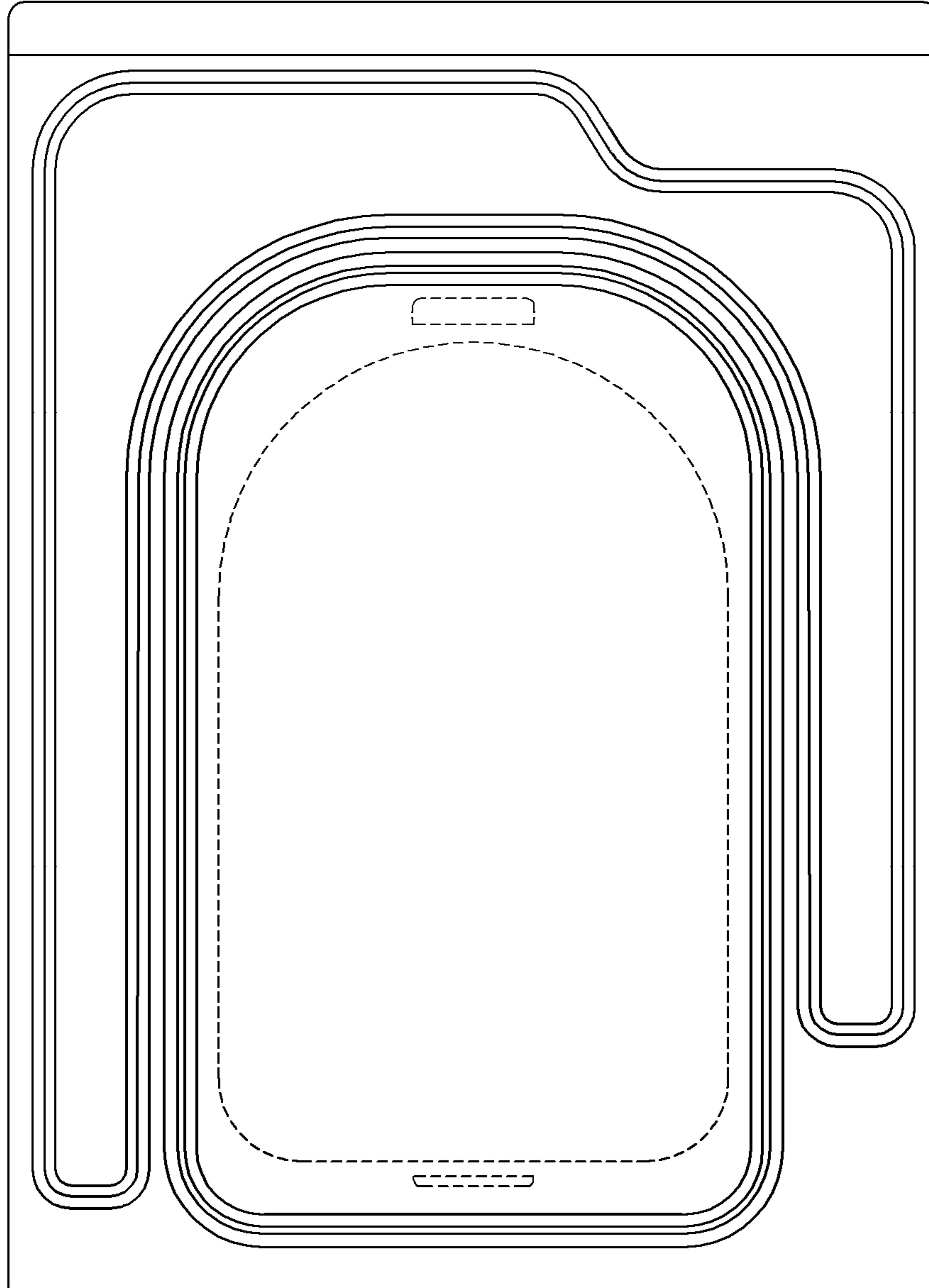

FIG. 4

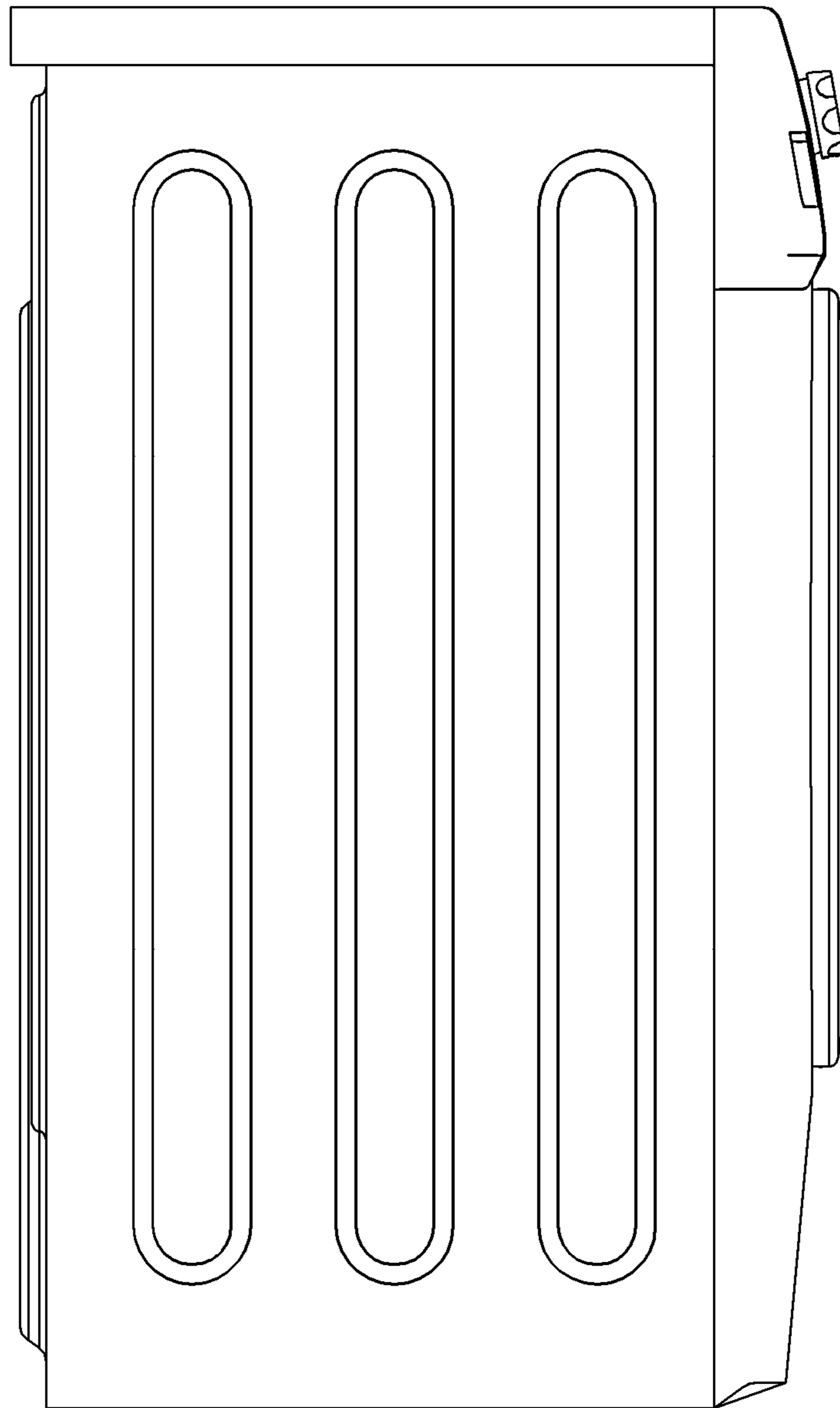

FIG. 5

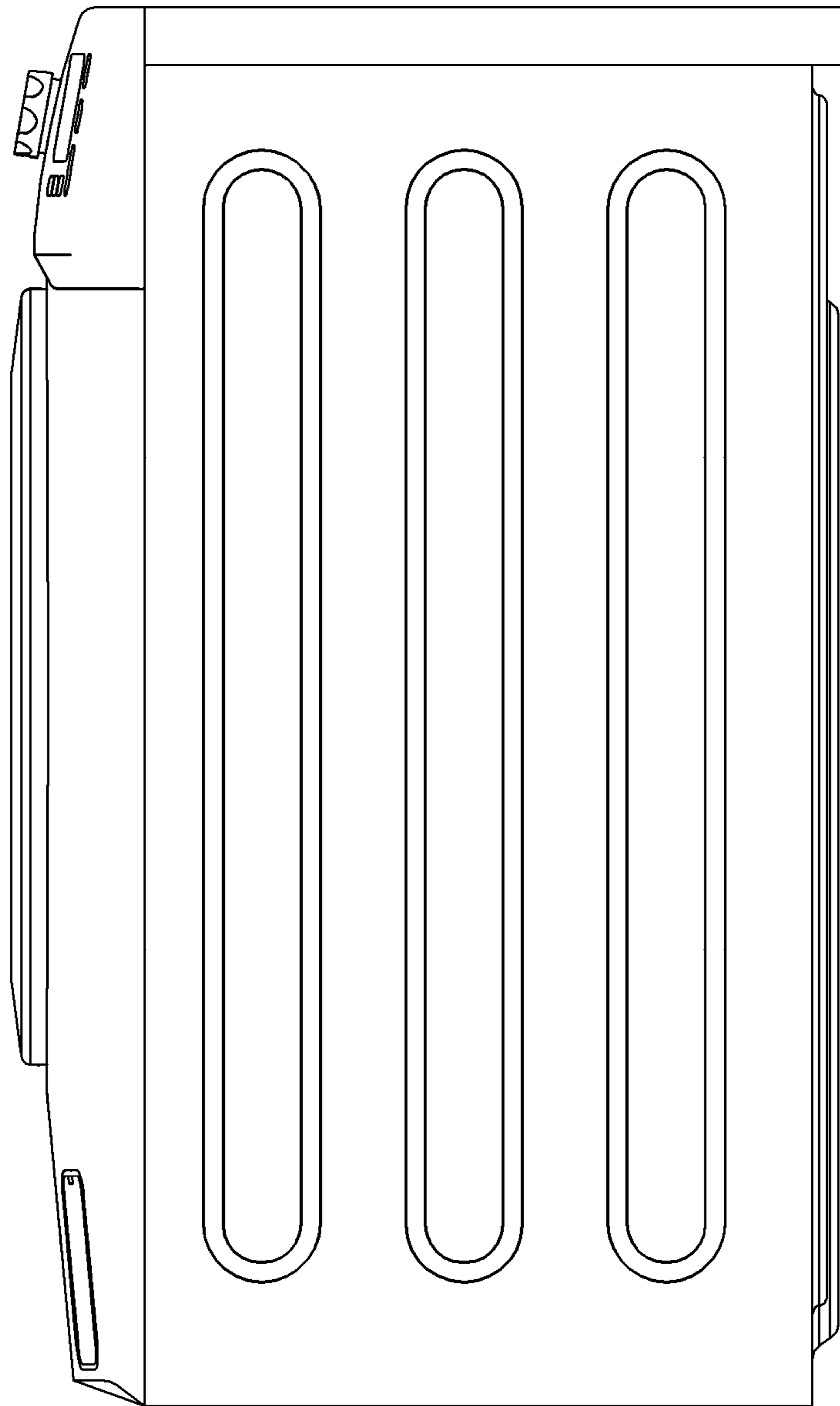

FIG. 6

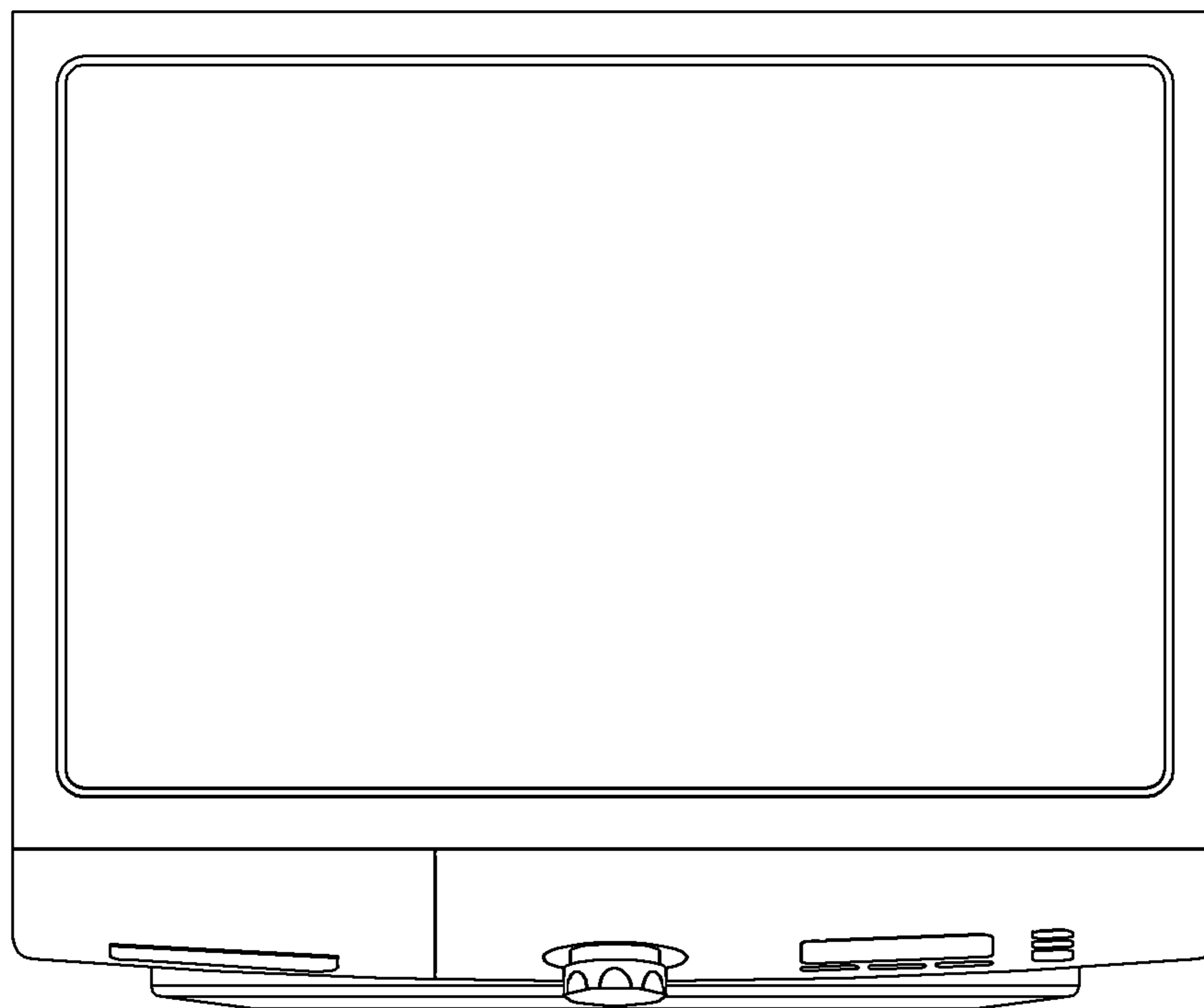

FIG. 7

