



US00D687978S

(12) **United States Design Patent**
Jeon et al.

(10) **Patent No.:** **US D687,978 S**

(45) **Date of Patent:** **** Aug. 13, 2013**

(54) **LED LIGHTING LAMP**

(56) **References Cited**

(75) Inventors: **Jong-hoon Jeon**, Seoul (KR); **Min-ho Cha**, Seoul (KR)

U.S. PATENT DOCUMENTS

D542,943	S	*	5/2007	Wang	D26/2
D546,980	S	*	7/2007	Lo	D26/2
D549,854	S	*	8/2007	Takahashi	D26/2
D566,300	S	*	4/2008	Lo	D26/2
D582,578	S	*	12/2008	Tsai et al.	D26/2
D593,223	S	*	5/2009	Komar	D26/2

(73) Assignee: **Samsung Electronics Co., Ltd.**, Suwon-Si (KR)

(**) Term: **14 Years**

* cited by examiner

(21) Appl. No.: **29/406,184**

Primary Examiner — Marcus Jackson

(22) Filed: **Nov. 10, 2011**

(74) *Attorney, Agent, or Firm* — McDermott Will & Emery LLP

(30) **Foreign Application Priority Data**

(57) **CLAIM**

The ornamental design for a LED lighting lamp, as shown.

Jun. 9, 2011 (KR) 30-2011-0023635

(51) **LOC (9) Cl.** **26-04**

(52) **U.S. Cl.**
USPC **D26/2**

(58) **Field of Classification Search**
USPC D26/1-4; 313/313, 315, 316, 317,
313/318, 493; 315/52, 53, 56, 57, 58

See application file for complete search history.

DESCRIPTION

FIG. 1 is a perspective view of a LED lighting lamp, in accordance with our new design; FIG. 2 is a front view thereof; FIG. 3 is a rear view thereof; FIG. 4 is a left-side view thereof; FIG. 5 is a right-side view thereof; FIG. 6 is a plan view thereof; and, FIG. 7 is a bottom view thereof.

1 Claim, 7 Drawing Sheets

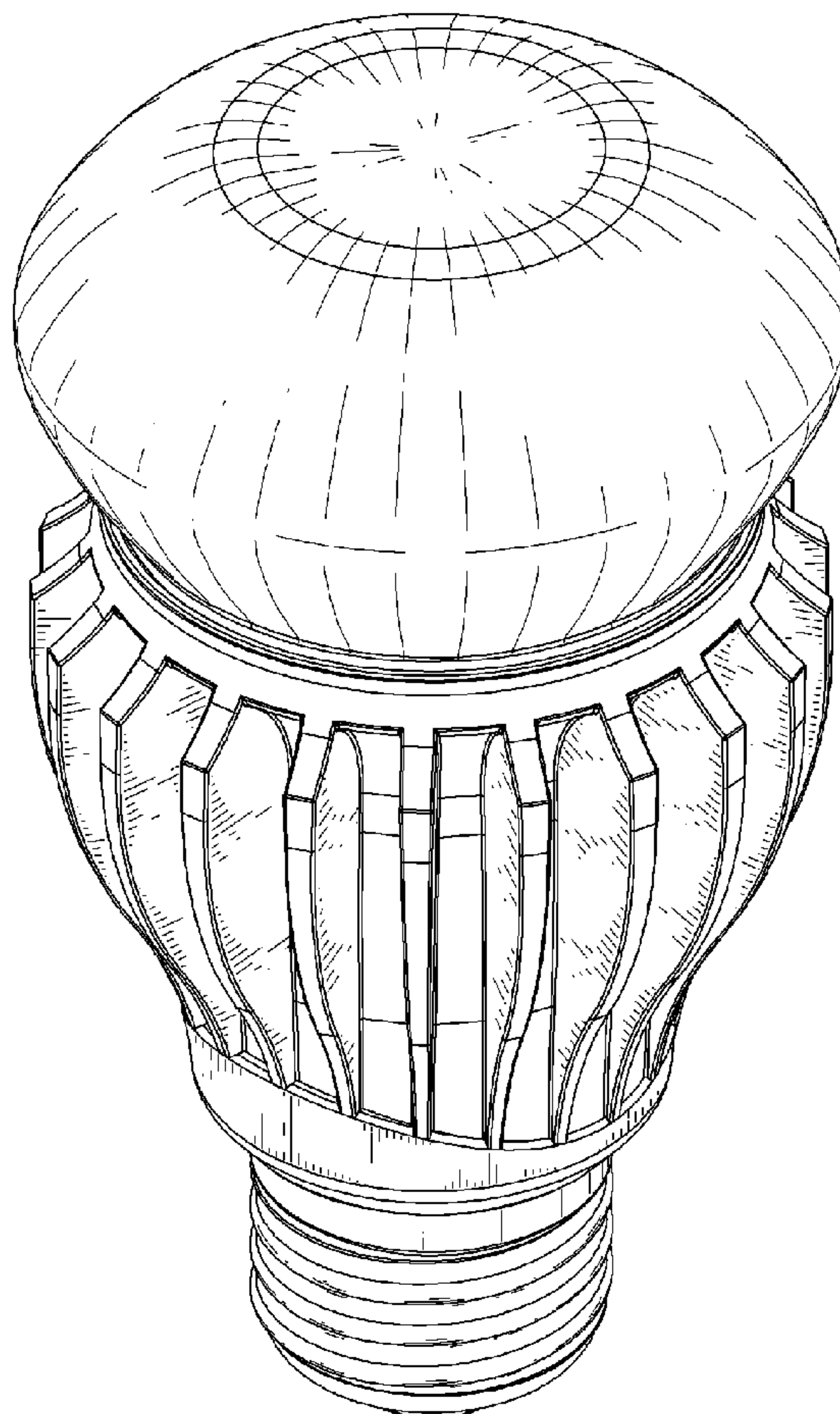

FIG. 1

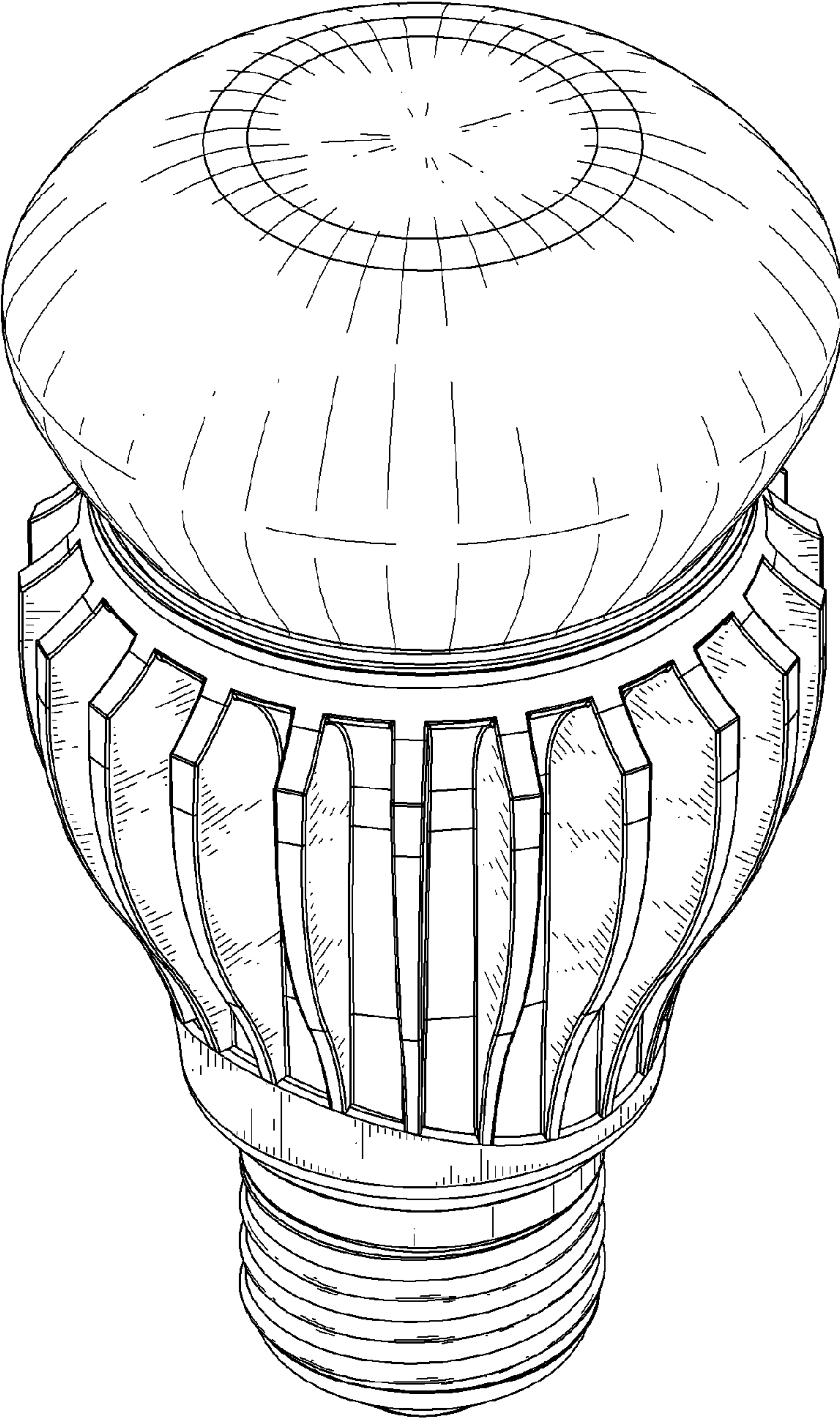

FIG. 2

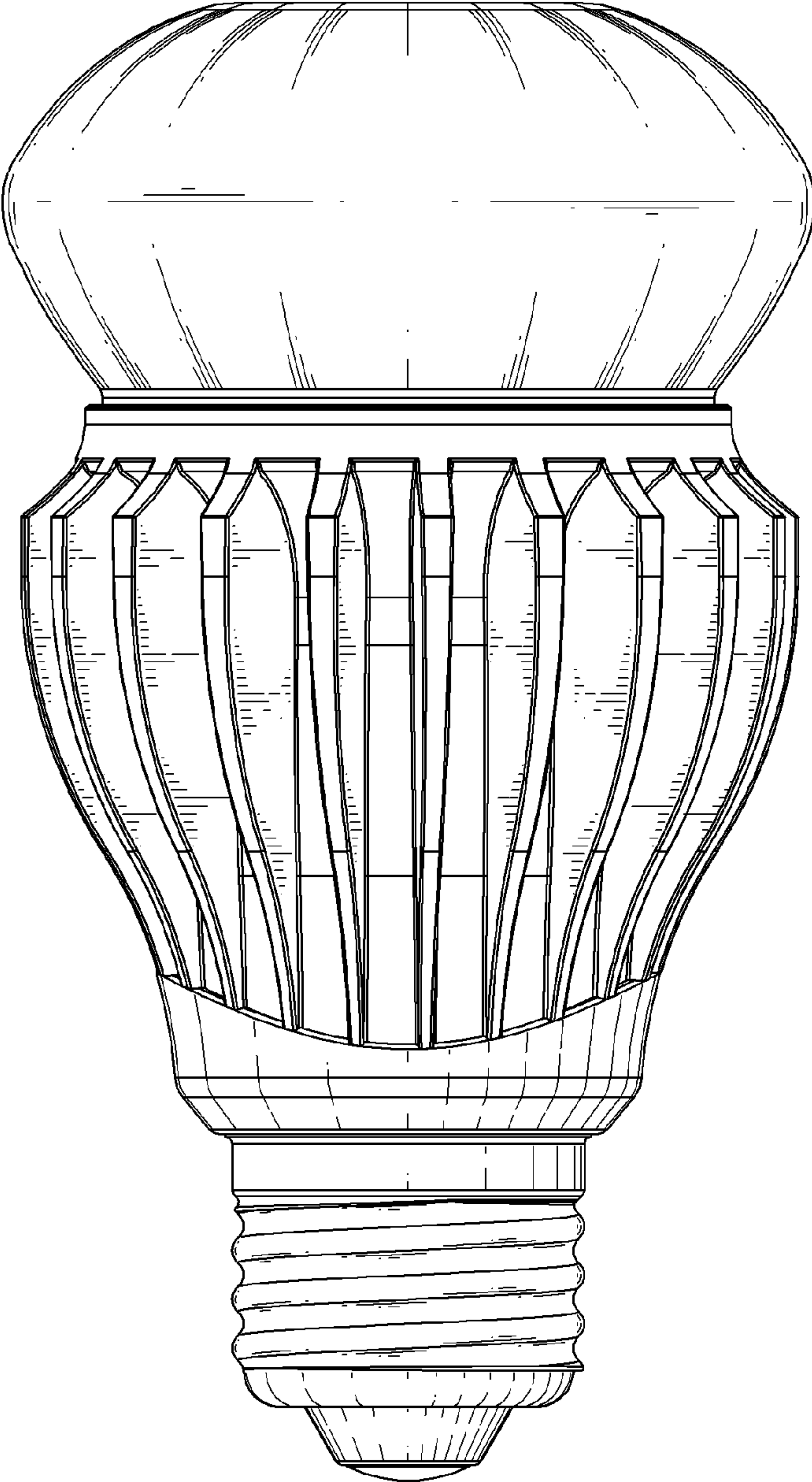

FIG. 3

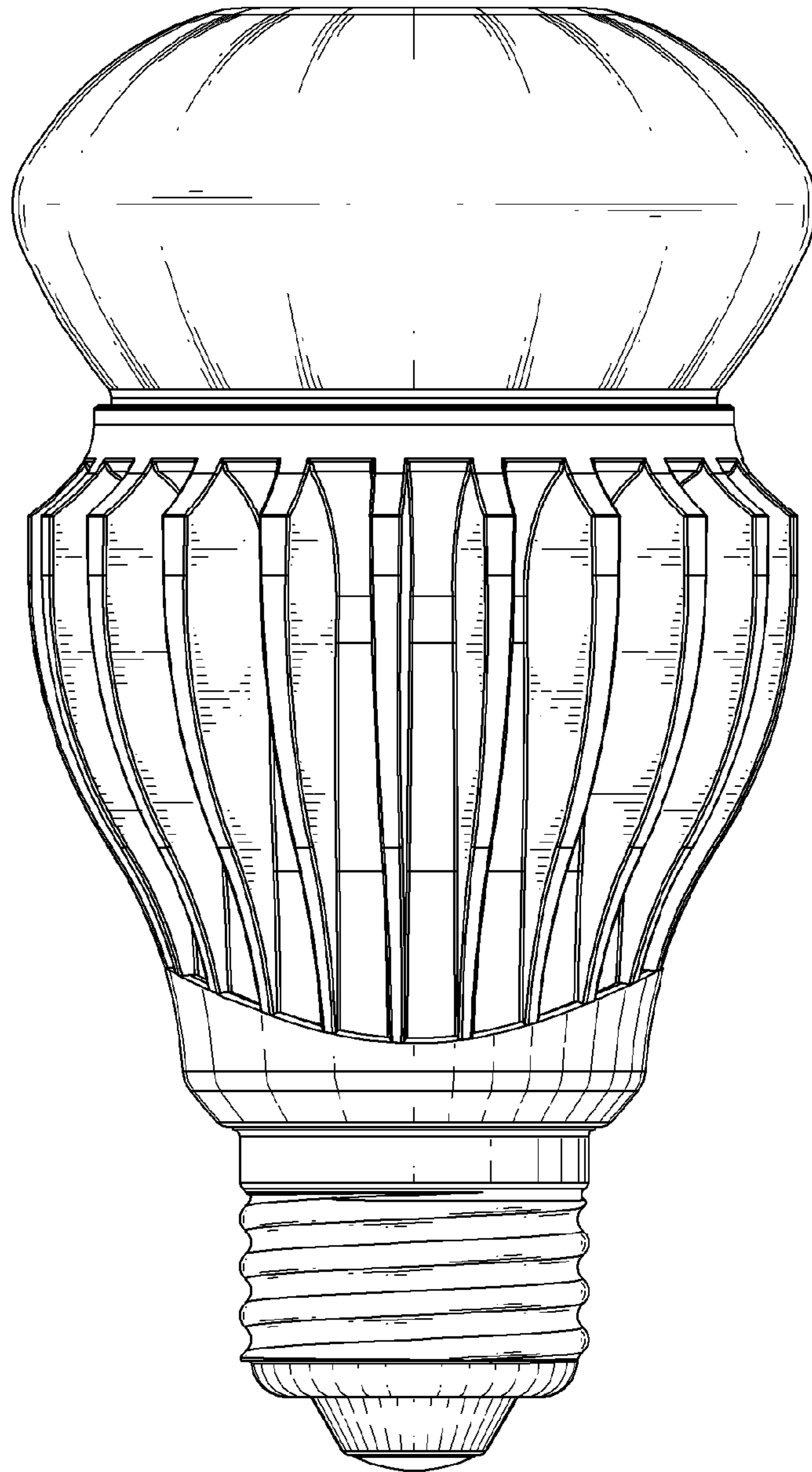

FIG. 4

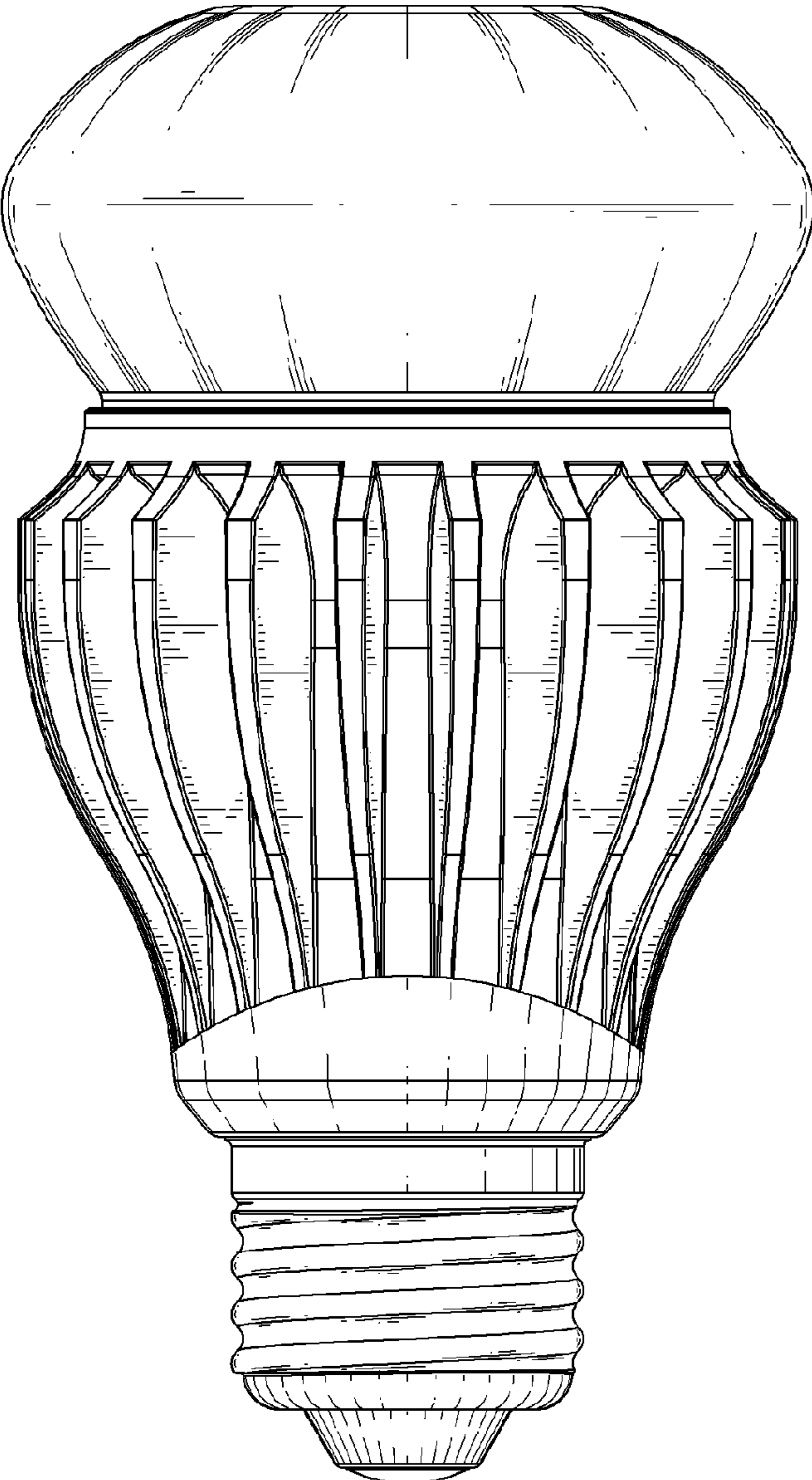

FIG. 5

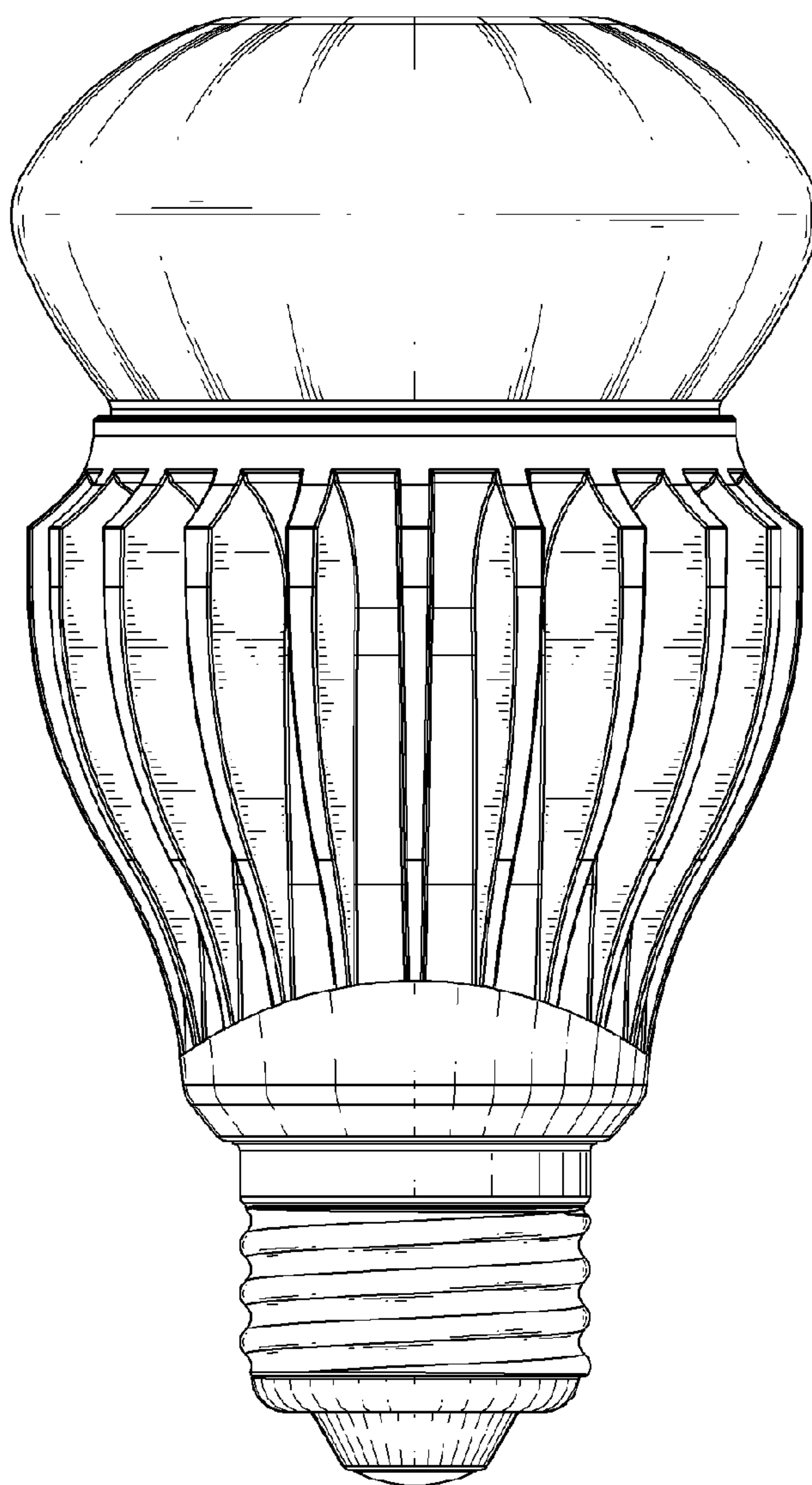

FIG. 6

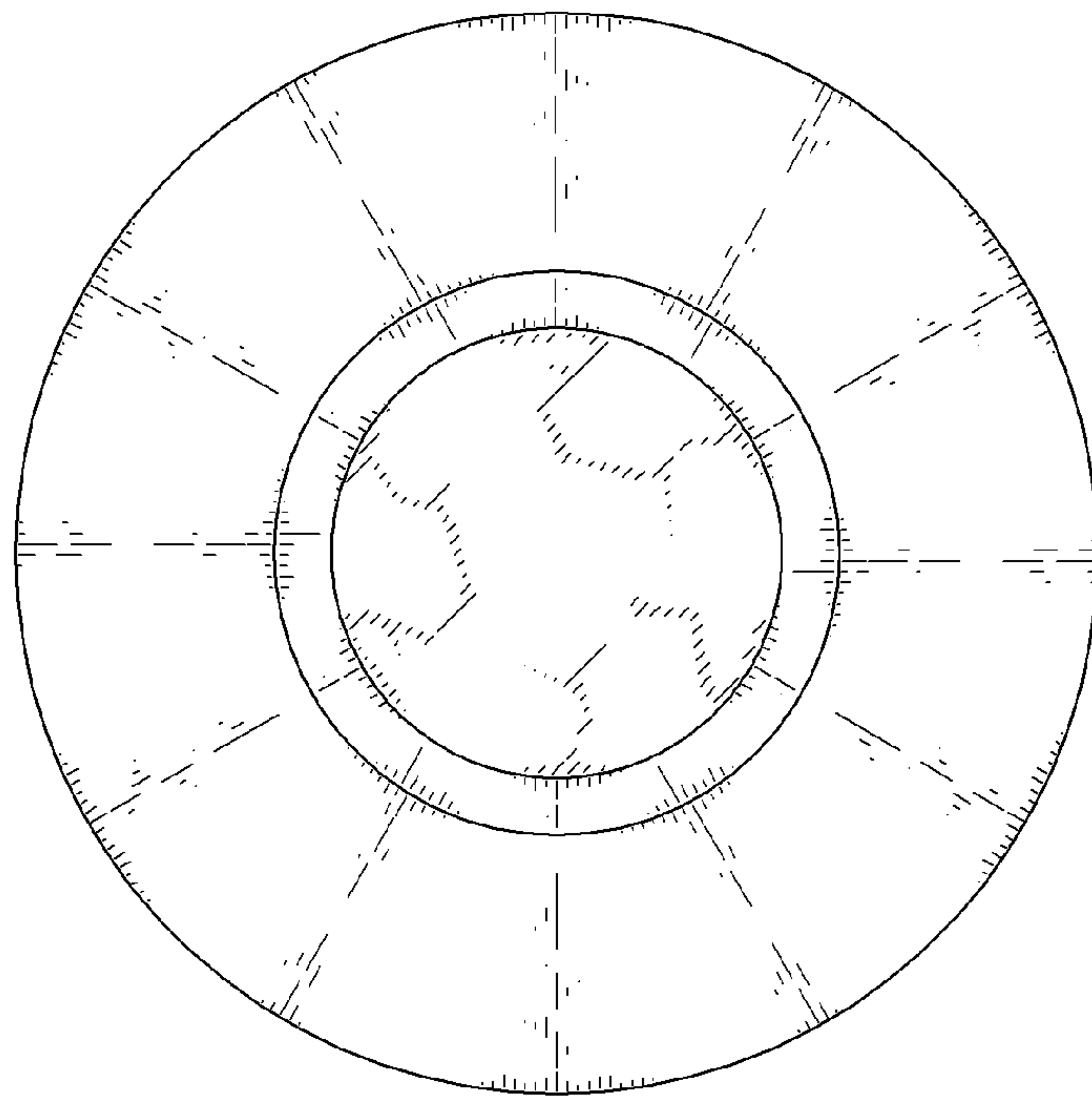

FIG. 7

