



US00D687938S

(12) **United States Design Patent**
Furner et al.

(10) **Patent No.:** **US D687,938 S**

(45) **Date of Patent:** **** Aug. 13, 2013**

(54) **FITTING FOR AN AIR TREATMENT
CHEMICAL DISPENSER**

(75) Inventors: **Paul E. Furner**, Racine, WI (US);
Donald J. Schumacher, Racine, WI
(US); **Phillip Kongshaug**, Racine, WI
(US); **Robert B. Hubler**, Woodinville,
WA (US)

(73) Assignee: **S. C. Johnson & Son, Inc.**, Racine, WI
(US)

(**) Term: **14 Years**

(21) Appl. No.: **29/426,012**

(22) Filed: **Jun. 29, 2012**

(51) **LOC (9) Cl.** **28-99**

(52) **U.S. Cl.**
USPC **D23/366**

(58) **Field of Classification Search**
USPC D23/355-369; D28/5, 6; 261/DIG. 17,
261/DIG. 42, DIG. 65, DIG. 88, DIG. 89,
261/DIG. 47, DIG. 55, DIG. 70; 392/356,
392/390, 392, 394, 395; 239/34, 44, 53,
239/55, 56, 326, 60, 308
See application file for complete search history.

(56) **References Cited**

U.S. PATENT DOCUMENTS

2,742,342	A	4/1956	Dew et al.	
3,285,694	A	11/1966	Marchi	
D288,842	S *	3/1987	Kwiatkowski	D23/366
D292,311	S *	10/1987	Joyaux et al.	D23/366
5,000,383	A *	3/1991	van der Heijden	239/47
D318,613	S *	7/1991	Halm et al.	D32/29.1
D318,912	S *	8/1991	von Philipp et al.	D23/366
D319,583	S *	9/1991	Halm et al.	D32/29.1
D319,781	S *	9/1991	Halm et al.	D32/29.1

D449,877	S *	10/2001	Delmenico et al.	D23/356
6,503,459	B1	1/2003	Leonard et al.	
6,780,382	B2	8/2004	Furner et al.	
D553,231	S *	10/2007	Li	D23/366
D557,784	S *	12/2007	Stead	D23/364
7,553,041	B1	6/2009	Terhune	
D598,527	S *	8/2009	Fitsch	D23/356
D614,277	S *	4/2010	Hsiao	D23/366
D621,494	S *	8/2010	Li	D23/366
D635,635	S	4/2011	Pryor	
8,047,837	B2	11/2011	Furner et al.	

FOREIGN PATENT DOCUMENTS

EM	001207138-0001	9/2010
WO	WO 2006/031669	3/2006

* cited by examiner

Primary Examiner — Sandra Snapp

(57) **CLAIM**

The ornamental design for a fitting for an air treatment chemical dispenser, as shown and described.

DESCRIPTION

FIG. 1 is a front perspective view of a preferred embodiment of our invention;
FIG. 2 is a front elevational view thereof;
FIG. 3 is a rear elevational view thereof;
FIG. 4 is a right side elevational view thereof;
FIG. 5 is a left side elevational view thereof;
FIG. 6 is a top plan view thereof; and,
FIG. 7 is a bottom plan view thereof.

The dotted line representations of the heat dispersal fins in the figures are for purposes of illustration only and form no part of the claimed design.

In a preferred embodiment the fitting is useful in connection with a dispenser that dispenses insect repellent in response to heat, such as that provided by a lit candle.

1 Claim, 5 Drawing Sheets

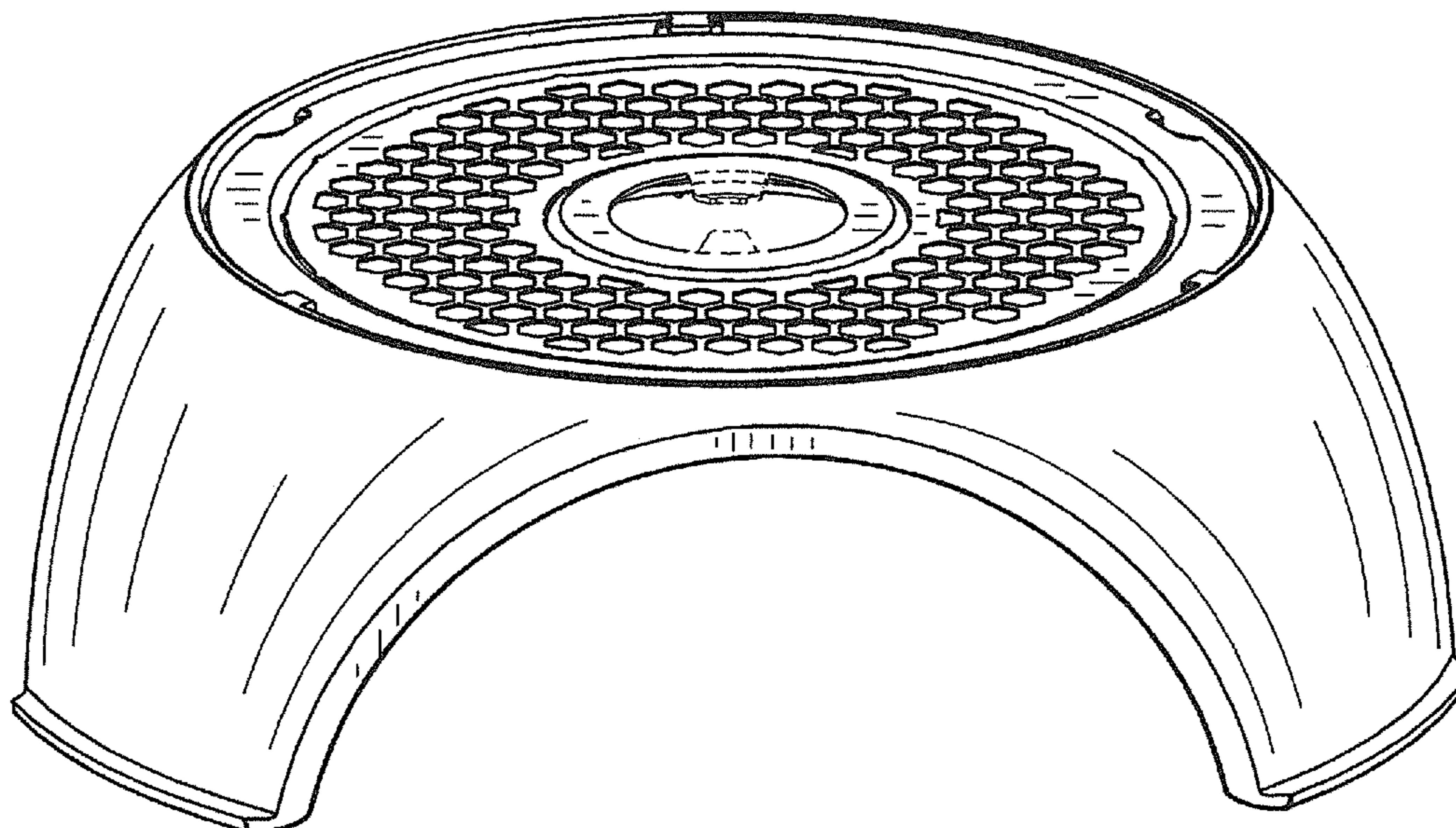

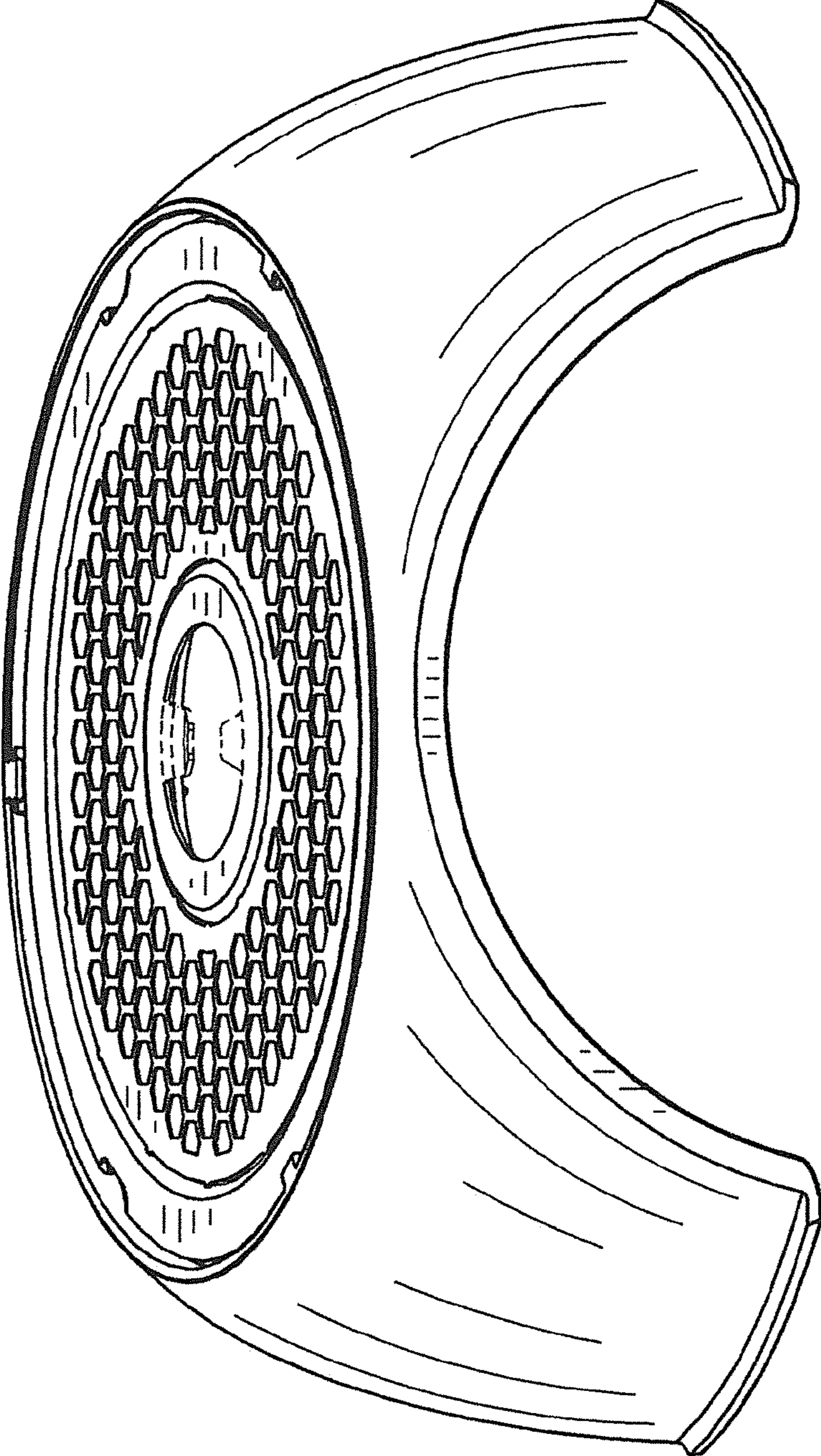

FIG. 1

FIG. 2

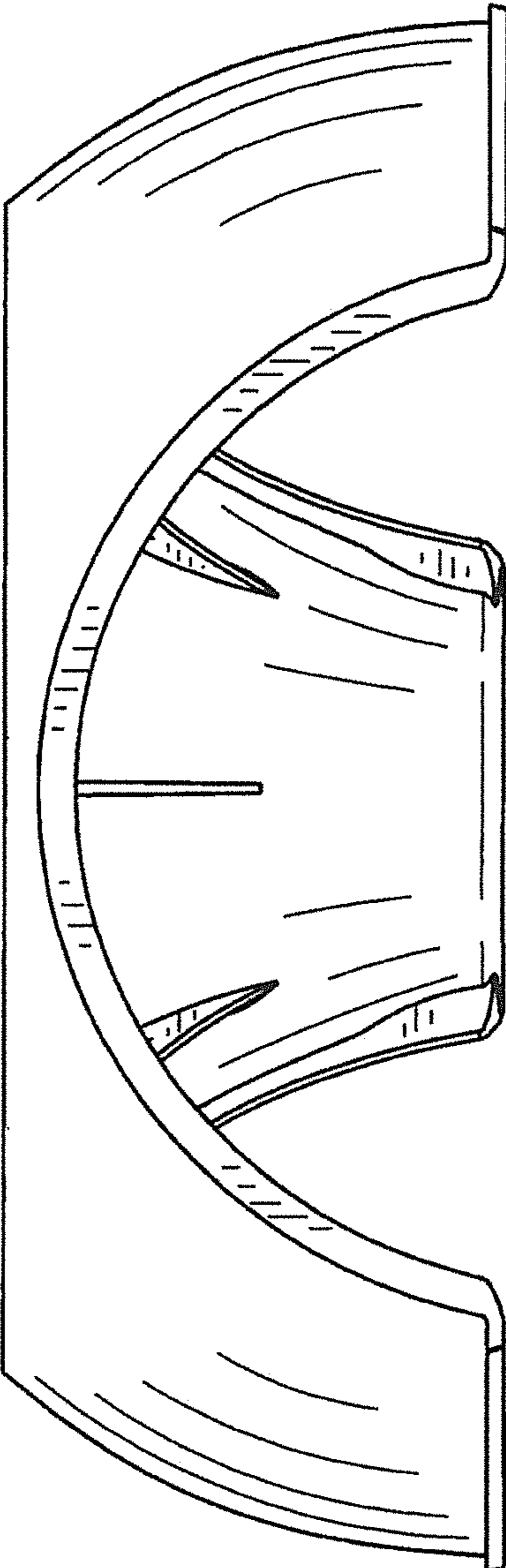

FIG. 3

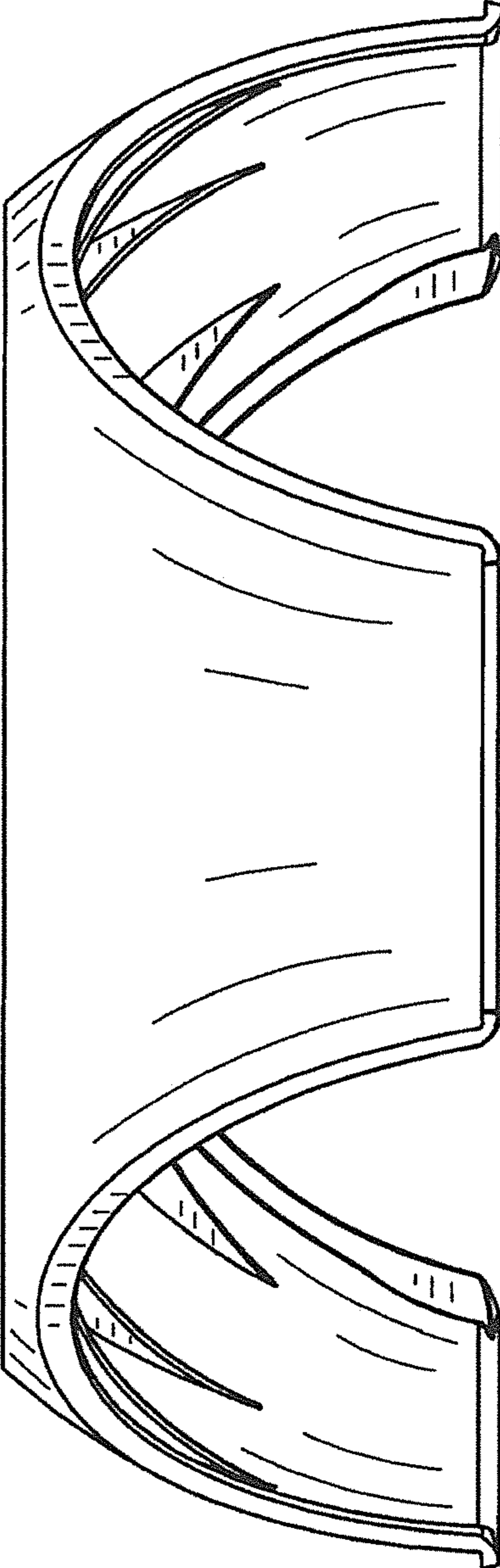

FIG. 4

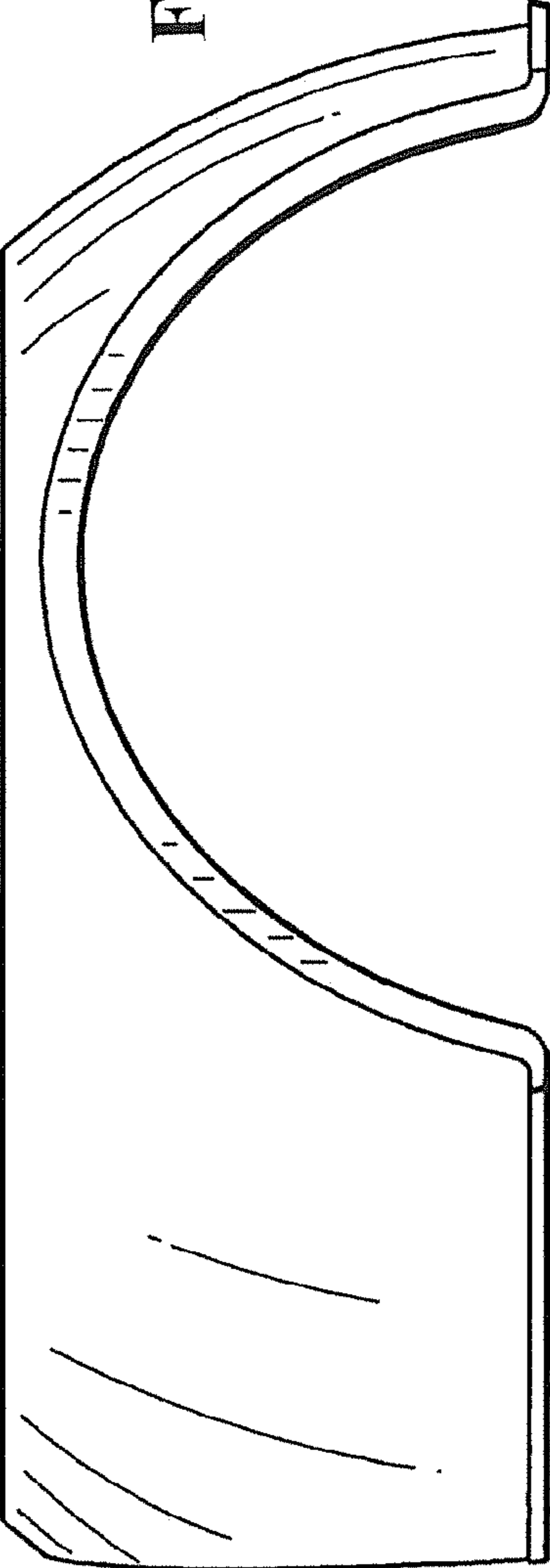
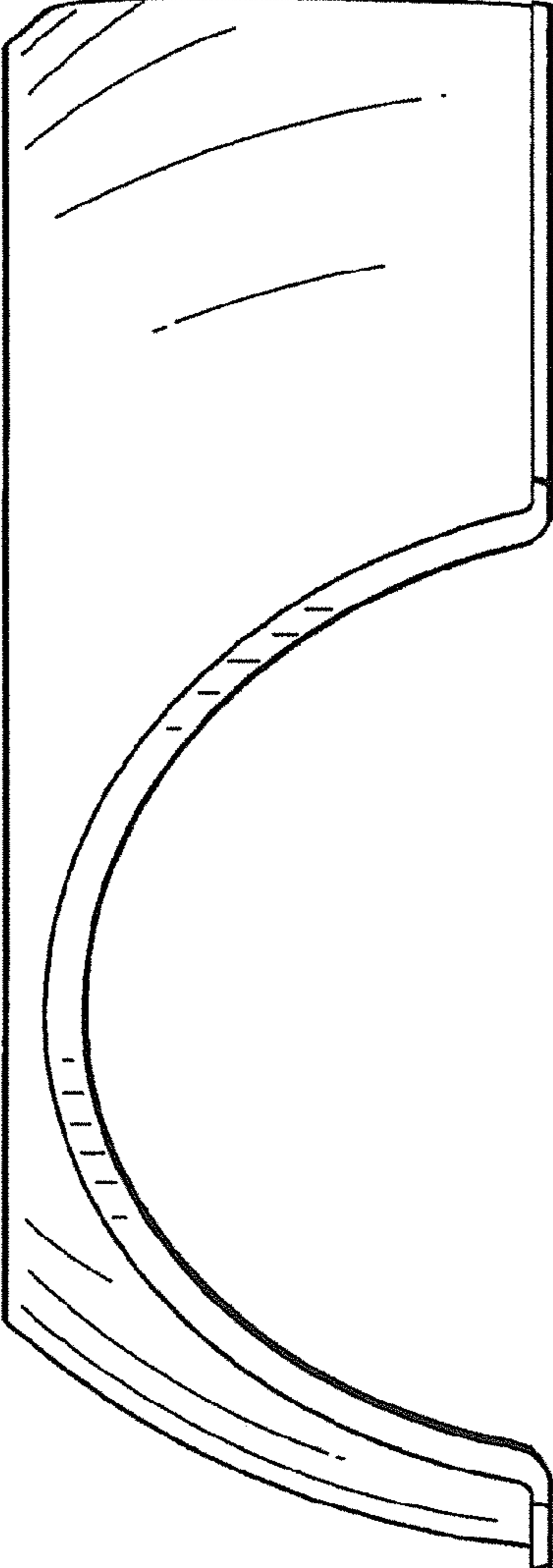

FIG. 5



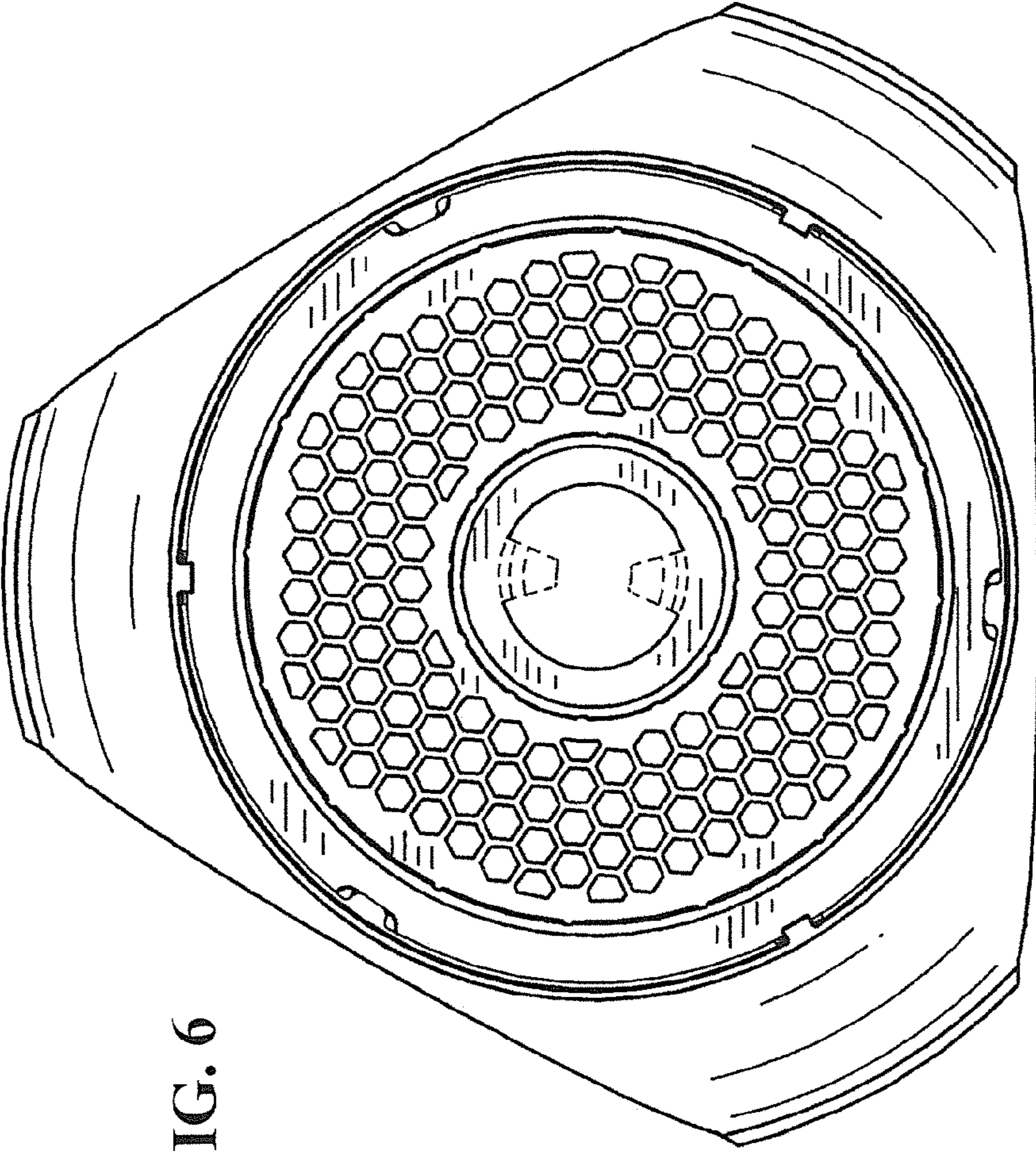

FIG. 6

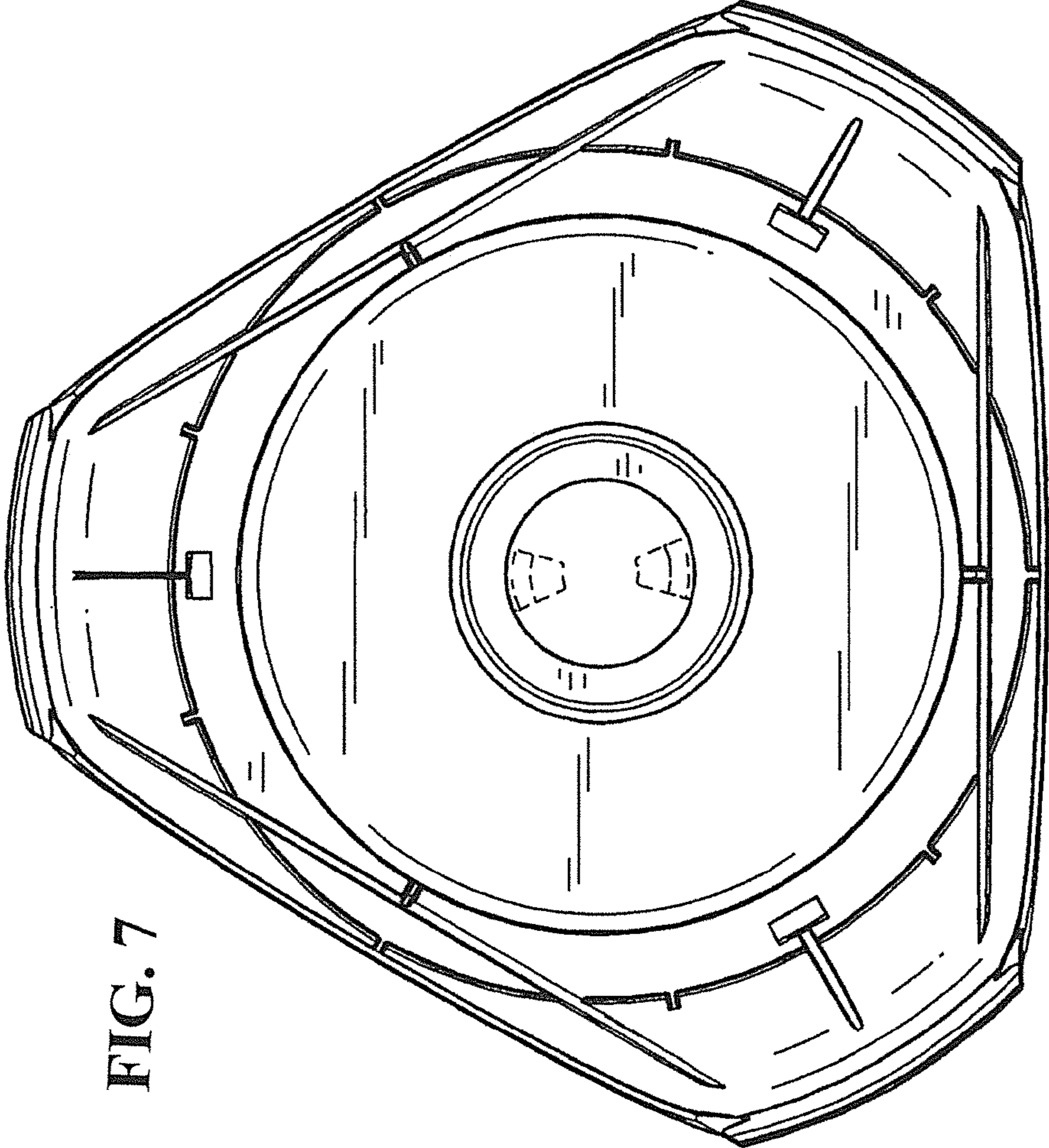

FIG. 7