



US00D687886S

(12) **United States Design Patent**
Ahrabian

(10) **Patent No.:** **US D687,886 S**
(45) **Date of Patent:** **** Aug. 13, 2013**

(54) **METAL TRANSACTION CARD**

DESCRIPTION

- (71) Applicant: **Darius Ahrabian**, Gruenwald (DE)
- (72) Inventor: **Darius Ahrabian**, Gruenwald (DE)
- (**) Term: **14 Years**
- (21) Appl. No.: **29/439,944**
- (22) Filed: **Dec. 17, 2012**

Related U.S. Application Data

- (62) Division of application No. 29/366,588, filed on Jul. 27, 2010, now Pat. No. Des. 672,807.
- (51) **LOC (9) Cl.** **19-08**
- (52) **U.S. Cl.**
USPC **D19/9**
- (58) **Field of Classification Search**
USPC ... D19/1-12, 20-34, 100; 40/124.01-124.15, 40/672, 661, 726, 617, 776; 283/72, 74, 103, 283/105-106; D6/407, 632; 235/380, 449, 235/484, 492, 493, 488; D20/10, 22, 17, D20/27, 40, 11; D14/435-437, 478
See application file for complete search history.

(56) **References Cited**

U.S. PATENT DOCUMENTS

D436,620 S *	1/2001	Webb et al.	D19/10
D481,068 S *	10/2003	Blossom et al.	D19/10
D623,690 S *	9/2010	Skelding et al.	D19/10
D635,186 S *	3/2011	Skelding et al.	D19/9
D643,062 S *	8/2011	Skelding et al.	D19/9

* cited by examiner

Primary Examiner — Caron D Veynar
Assistant Examiner — Abraham Bahta
 (74) *Attorney, Agent, or Firm* — MDIP LLC

(57) **CLAIM**

The ornamental design for a metal transaction card, as shown and described.

FIG. 1 depicts a front elevation view of embodiment of a metal transaction card, the metal transaction card having a carbon fiber inlay as shown.

FIG. 2 depicts a perspective view of the front of the metal transaction card of FIG. 1.

FIG. 3 depicts another perspective review of the front of the metal transaction card of FIG. 1.

FIG. 4 depicts a back elevation view of the metal transaction card of FIG. 1.

FIG. 5 depicts a top plan view of the metal transaction card of FIG. 1, the bottom plan view being the mirror image thereof.

FIG. 6 depicts a left elevation view of the metal transaction card of FIG. 1, the right elevation view being the mirror image thereof.

FIG. 7 depicts a front elevation view of another embodiment of a metal transaction card, the metal transaction card having a carbon fiber inlay as shown.

FIG. 8 depicts a perspective view of the front of the metal transaction card of FIG. 7.

FIG. 9 depicts another perspective review of the front of the metal transaction card of FIG. 7.

FIG. 10 depicts a back elevation view of the metal transaction card of FIG. 7.

FIG. 11 depicts a top plan view of the metal transaction card of FIG. 7, the bottom plan view being the mirror image thereof.

FIG. 12 depicts a left elevation view of the metal transaction card of FIG. 7, the right elevation view being the mirror image thereof.

FIG. 13 depicts a front elevation view of another embodiment of a metal transaction card, the metal transaction card having a carbon fiber inlay as shown.

FIG. 14 depicts a perspective view of the front of the metal transaction card of FIG. 13.

FIG. 15 depicts another perspective review of the front of the metal transaction card of FIG. 13.

FIG. 16 depicts a back elevation view of the metal transaction card of FIG. 13.

FIG. 17 depicts a top plan view of the metal transaction card of FIG. 13, the bottom plan view being the mirror image thereof.

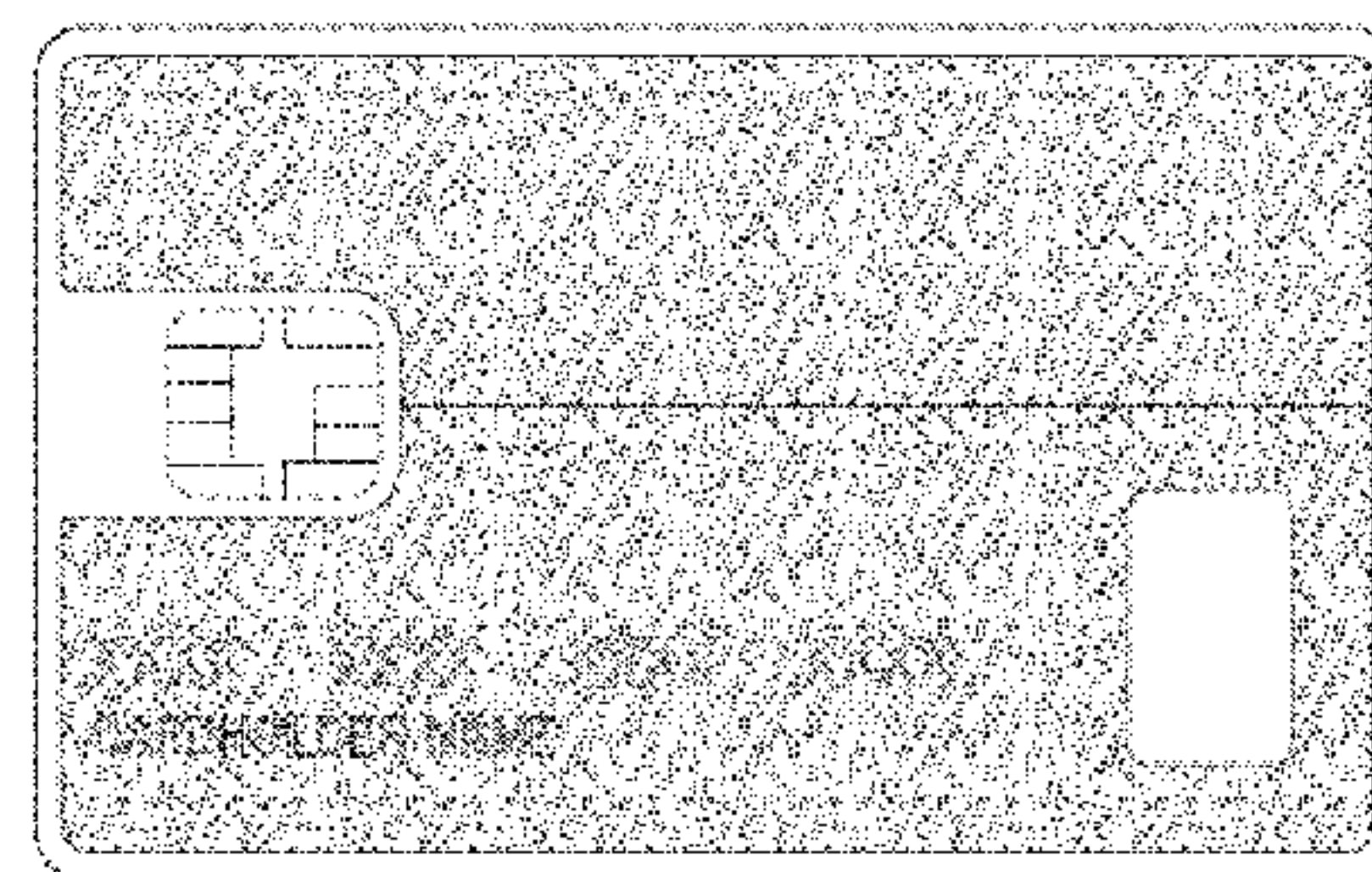
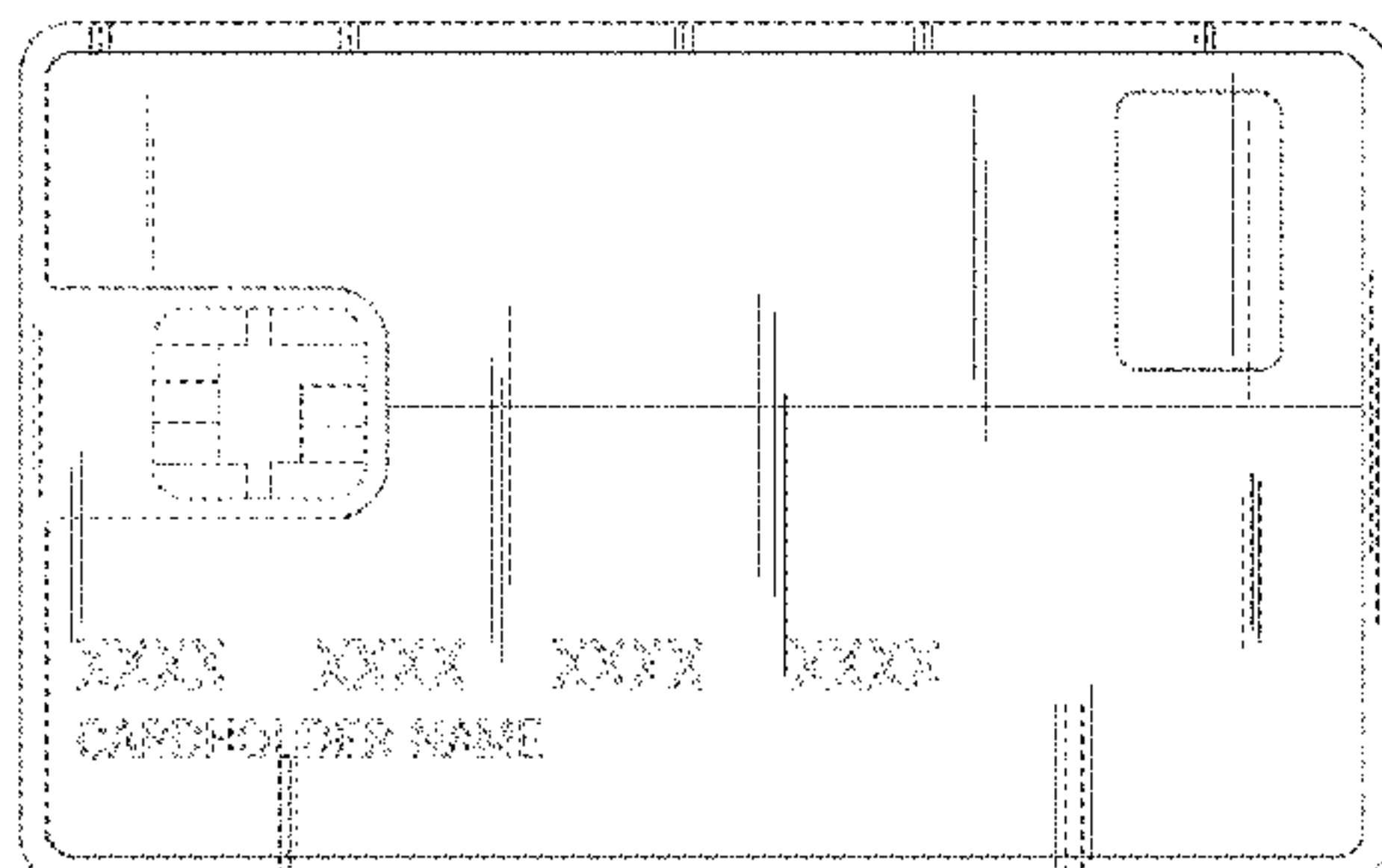

FIG. 71 depicts a top plan view of the metal transaction card of FIG. 67, the bottom plan view being the mirror image thereof.

FIG. 72 depicts a left elevation view of the metal transaction card of FIG. 67, the right elevation view being the mirror image thereof.

FIG. 73 depicts a front elevation view of another embodiment of a metal transaction card, the metal transaction card having a wood inlay as shown.

FIG. 74 depicts a perspective view of the front of the metal transaction card of FIG. 73.

FIG. 75 depicts another perspective review of the front of the metal transaction card of FIG. 73.

FIG. 76 depicts a back elevation view of the metal transaction card of FIG. 73.

FIG. 77 depicts a top plan view of the metal transaction card of FIG. 73, the bottom plan view being the mirror image thereof.

FIG. 78 depicts a left elevation view of the metal transaction card of FIG. 73, the right elevation view being the mirror image thereof.

FIG. 79 depicts a front elevation view of another embodiment of a metal transaction card, the metal transaction card having a wood inlay as shown.

FIG. 80 depicts a perspective view of the front of the metal transaction card of FIG. 79.

FIG. 81 depicts another perspective review of the front of the metal transaction card of FIG. 79.

FIG. 82 depicts a back elevation view of the metal transaction card of FIG. 79.

FIG. 83 depicts a top plan view of the metal transaction card of FIG. 79, the bottom plan view being the mirror image thereof.

FIG. 84 depicts a left elevation view of the metal transaction card of FIG. 79, the right elevation view being the mirror image thereof.

FIG. 85 depicts a front elevation view of another embodiment of a metal transaction card, the metal transaction card having a wood inlay as shown.

FIG. 86 depicts a perspective view of the front of the metal transaction card of FIG. 85.

FIG. 87 depicts another perspective review of the front of the metal transaction card of FIG. 85.

FIG. 88 depicts a back elevation view of the metal transaction card of FIG. 85.

FIG. 89 depicts a top plan view of the metal transaction card of FIG. 85, the bottom plan view being the mirror image thereof.

FIG. 90 depicts a left elevation view of the metal transaction card of FIG. 85, the right elevation view being the mirror image thereof.

FIG. 91 depicts a front elevation view of another embodiment of a metal transaction card, the metal transaction card having a wood inlay as shown.

FIG. 92 depicts a perspective view of the front of the metal transaction card of FIG. 91.

FIG. 93 depicts another perspective review of the front of the metal transaction card of FIG. 91.

FIG. 94 depicts a back elevation view of the metal transaction card of FIG. 91.

FIG. 95 depicts a top plan view of the metal transaction card of FIG. 91, the bottom plan view being the mirror image thereof; and,

FIG. 96 depicts a left elevation view of the metal transaction card of FIG. 91, the right elevation view being the mirror image thereof.

The broken lines in the drawings illustrate environmental structure on the article and form no part of the claimed design. For the embodiments that include a wood, leather, or carbon fiber inlay, the illustrated wood grain, leather grain, or carbon fiber pattern are exemplary only.

1 Claim, 32 Drawing Sheets

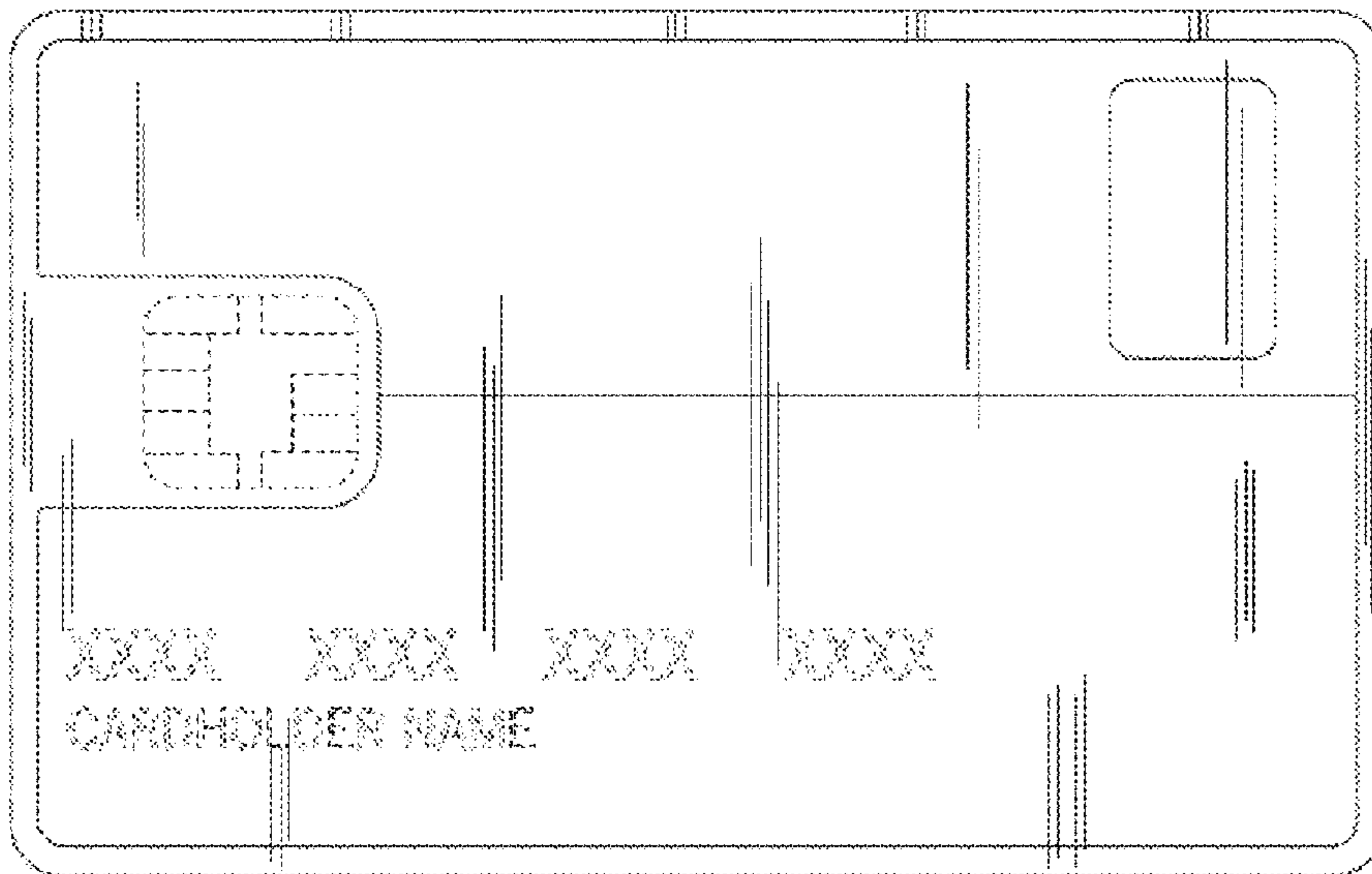

FIG. 1

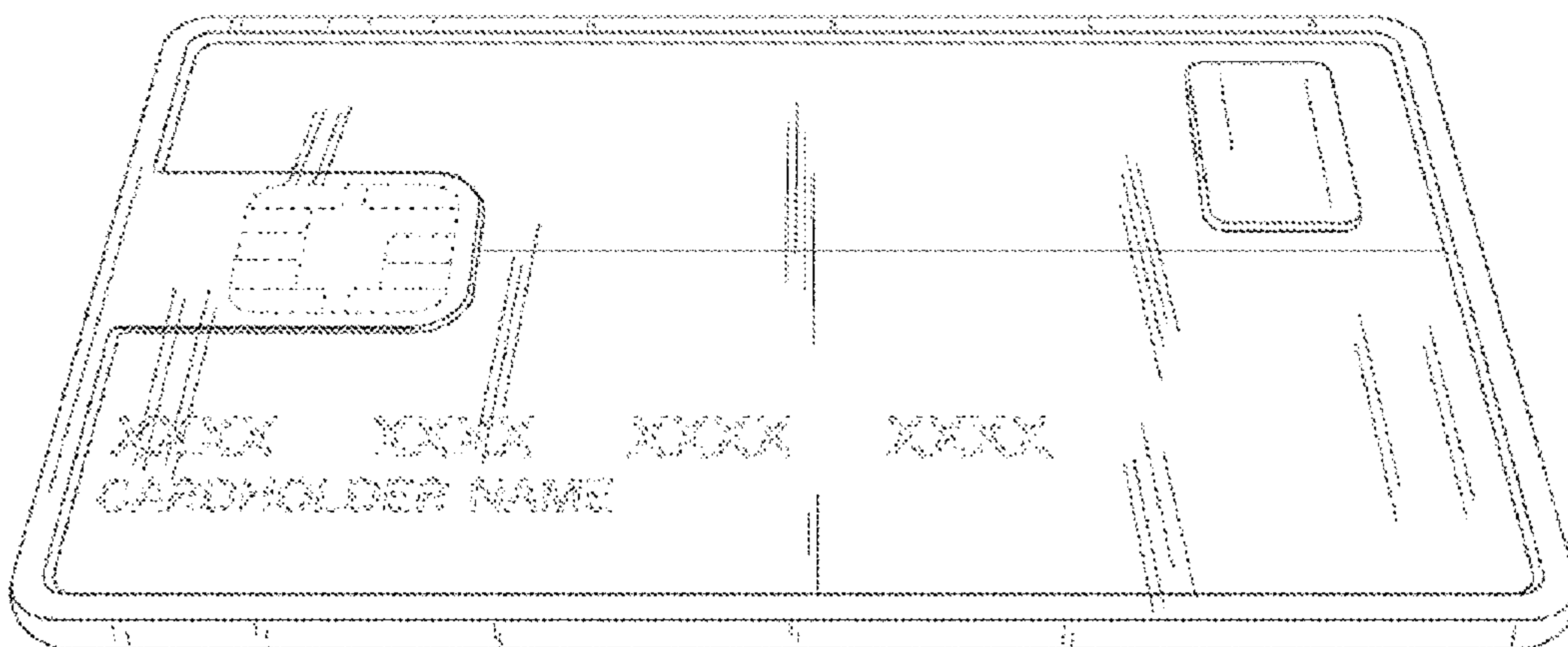

FIG. 2

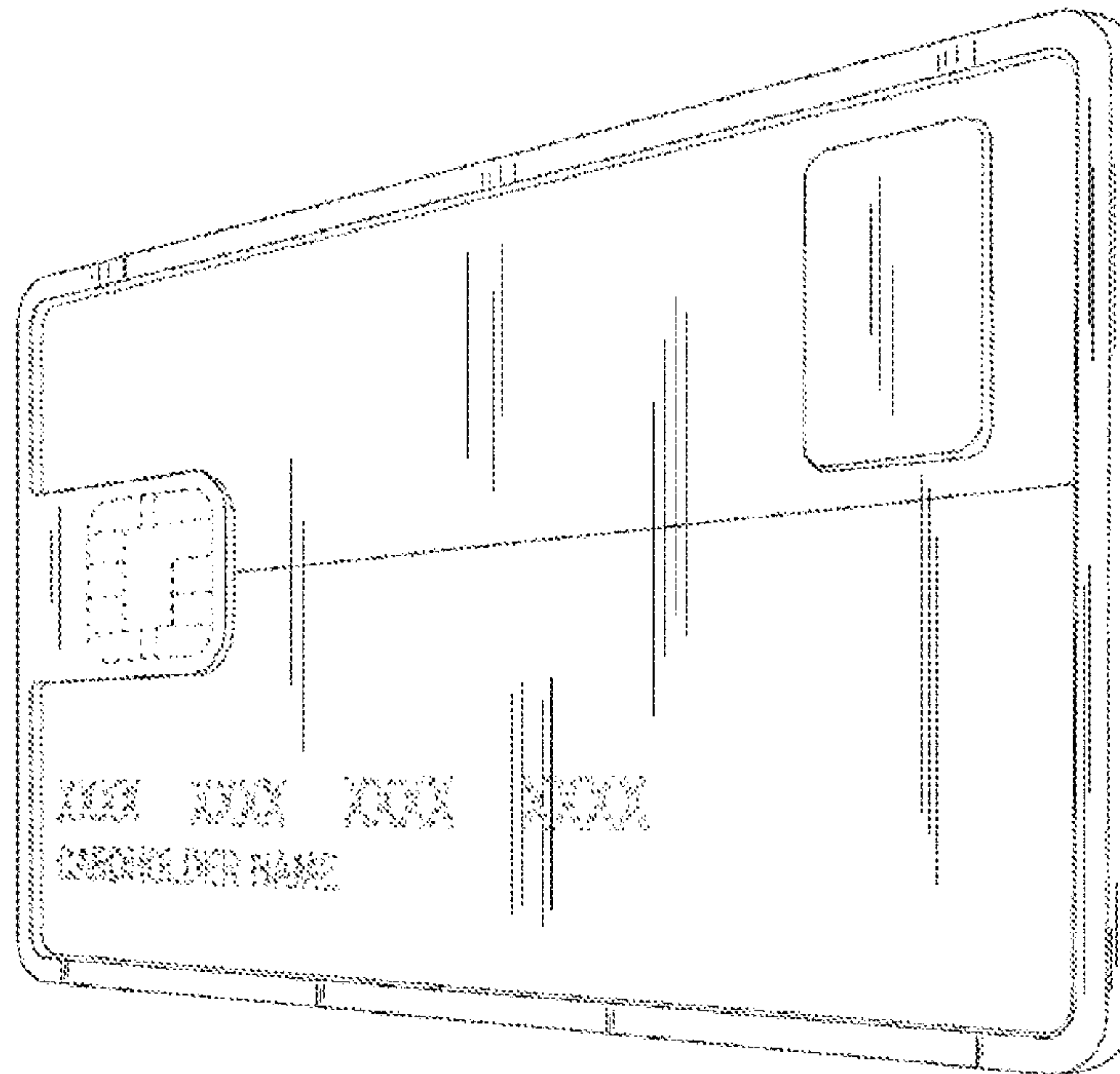

FIG. 3

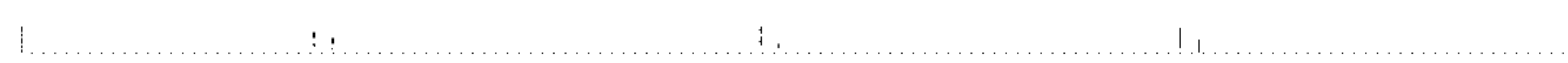

FIG. 5

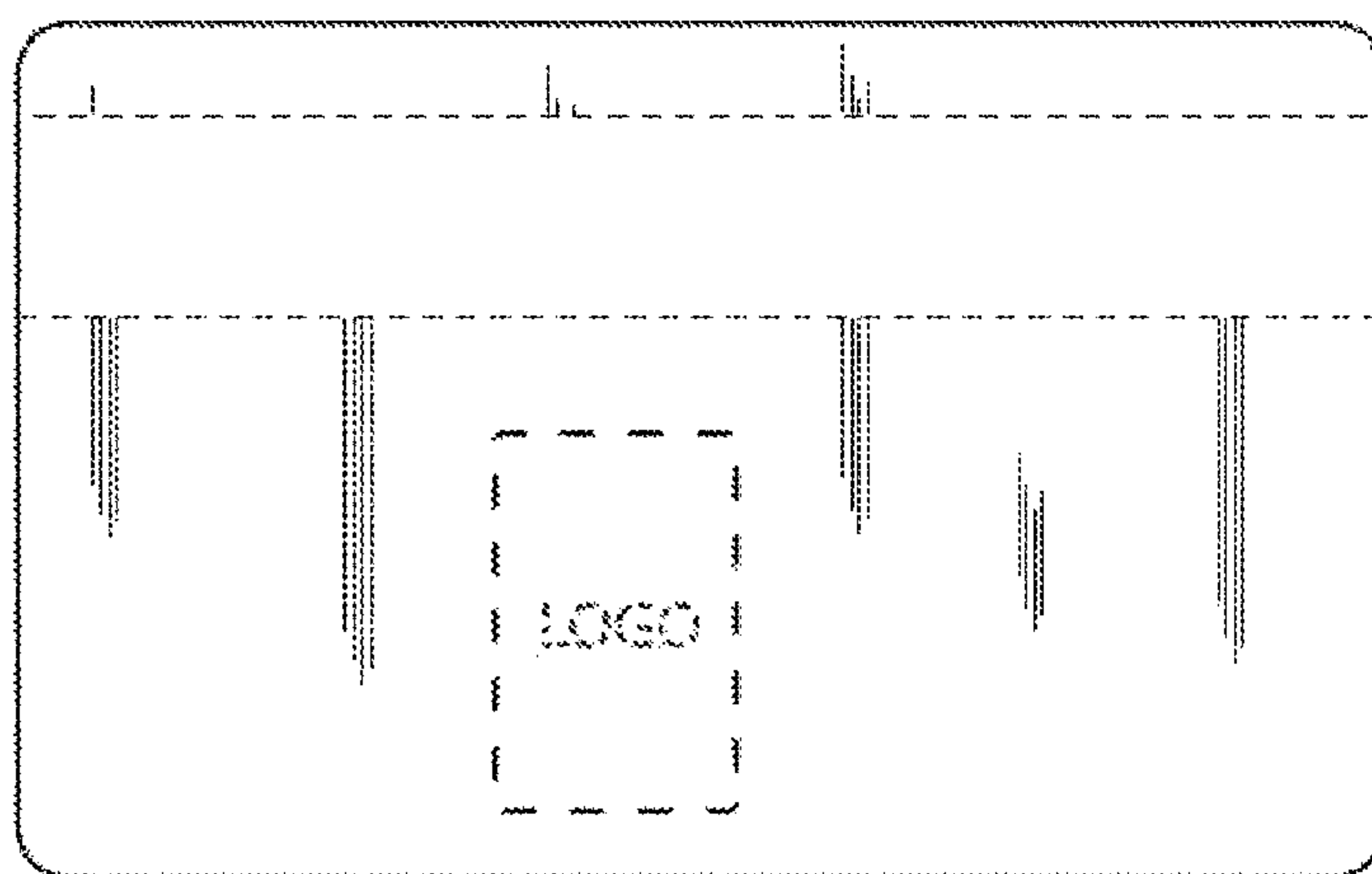

FIG. 4

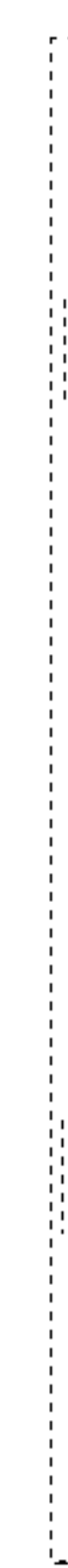

FIG. 6

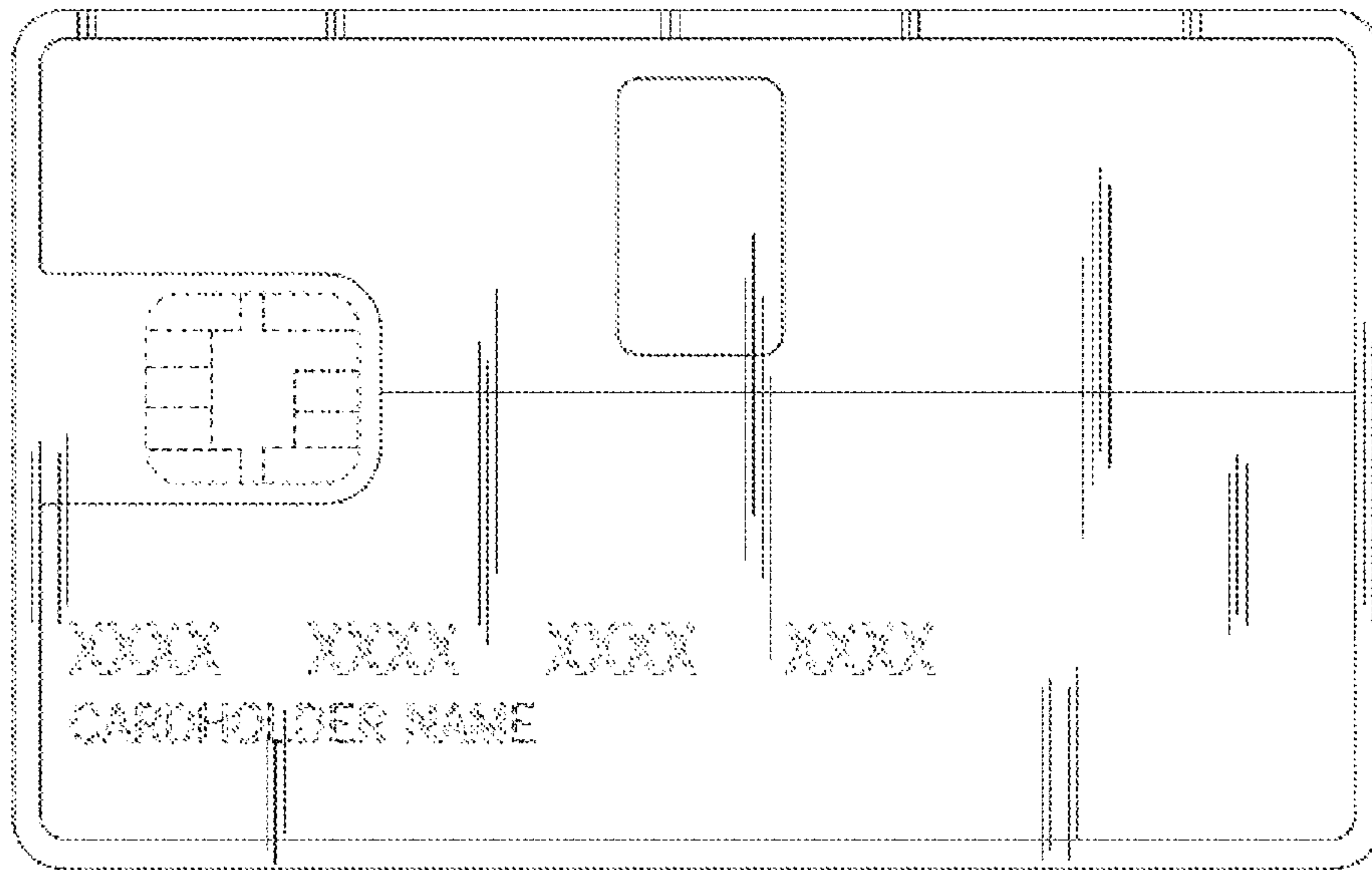

FIG. 7

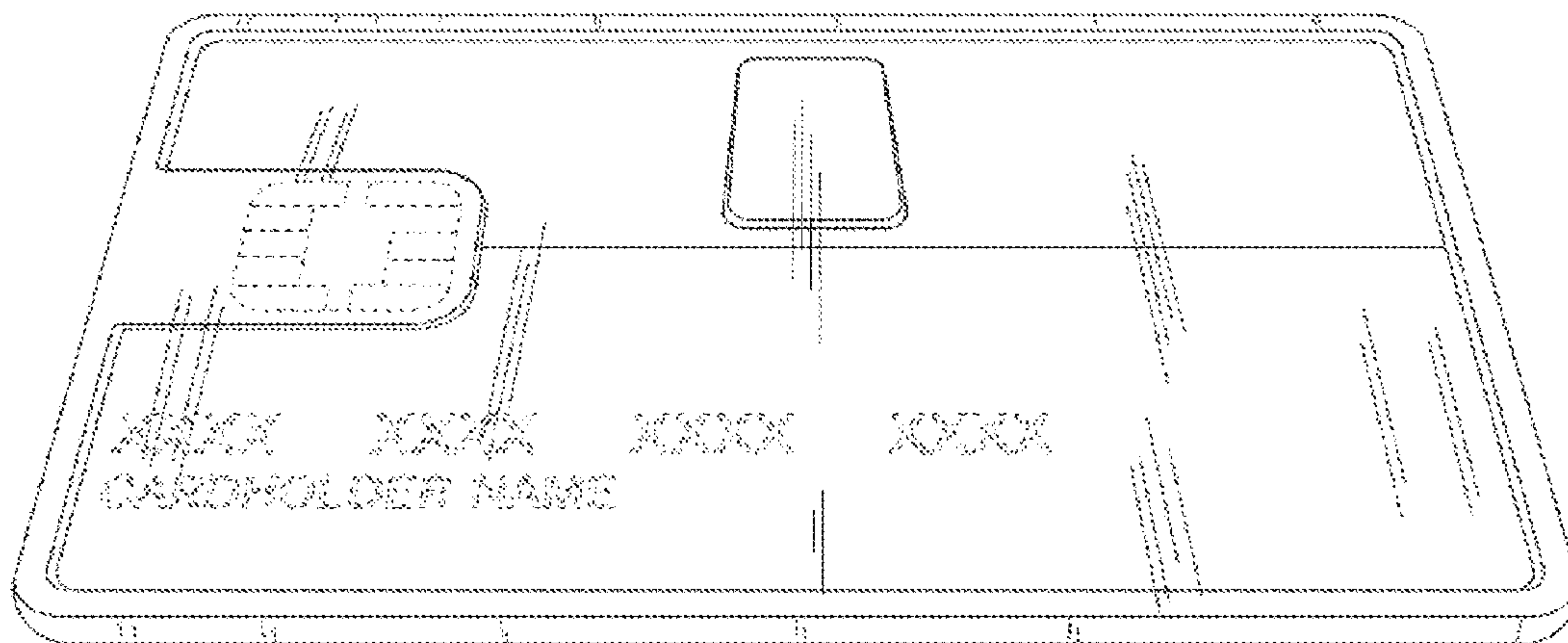

FIG. 8

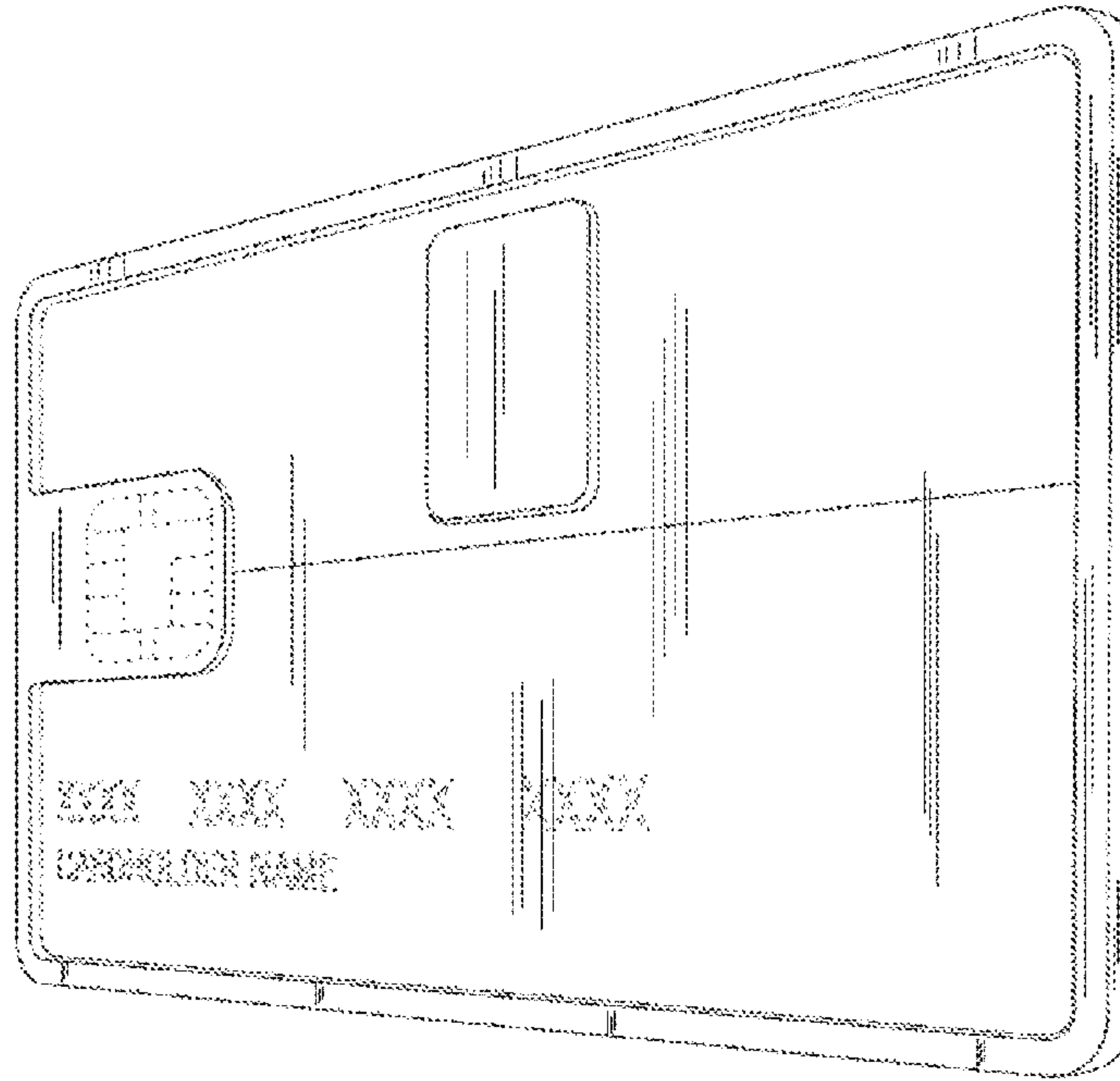

FIG. 9

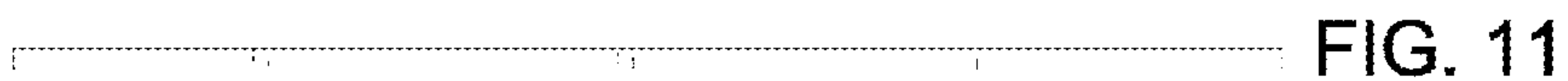

FIG. 11

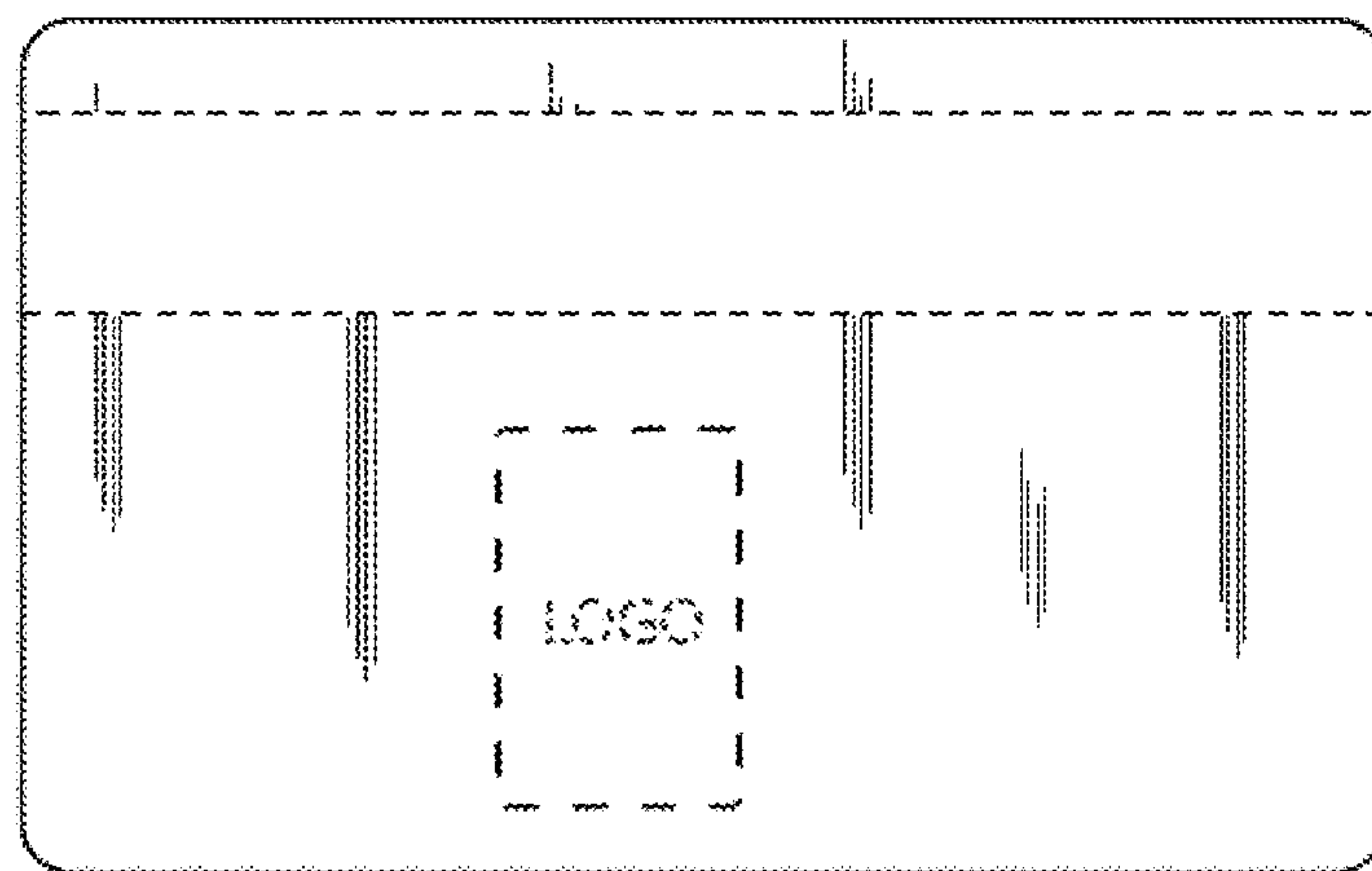

FIG. 10



FIG. 12

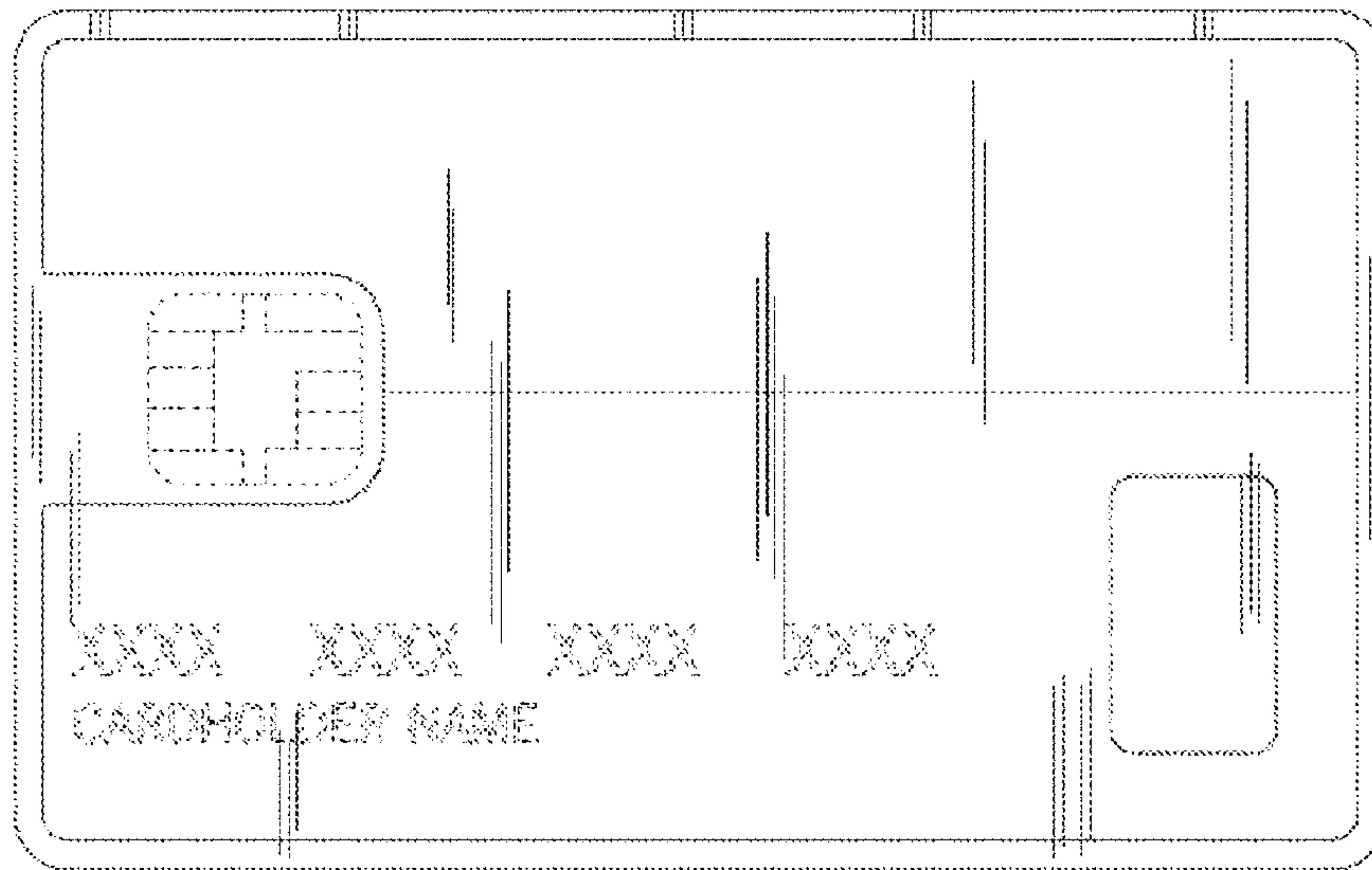

FIG. 13

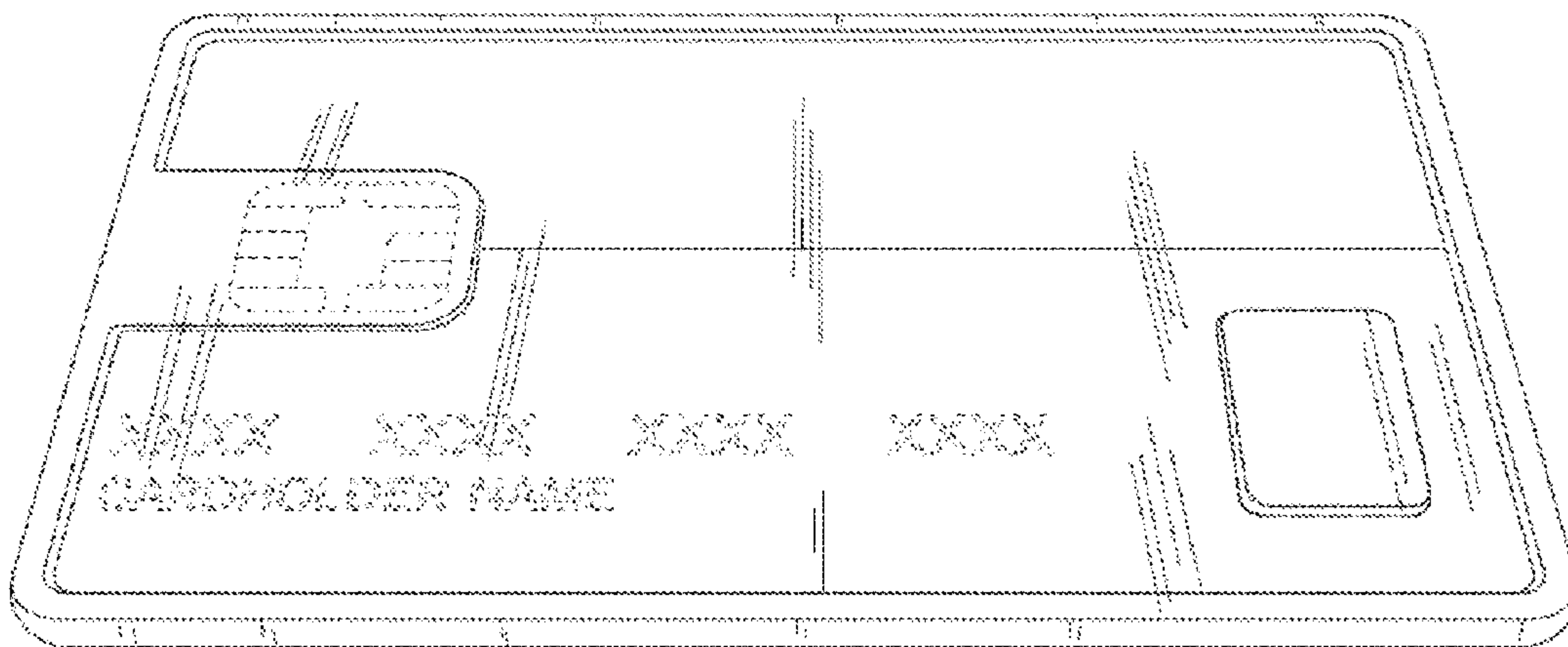

FIG. 14

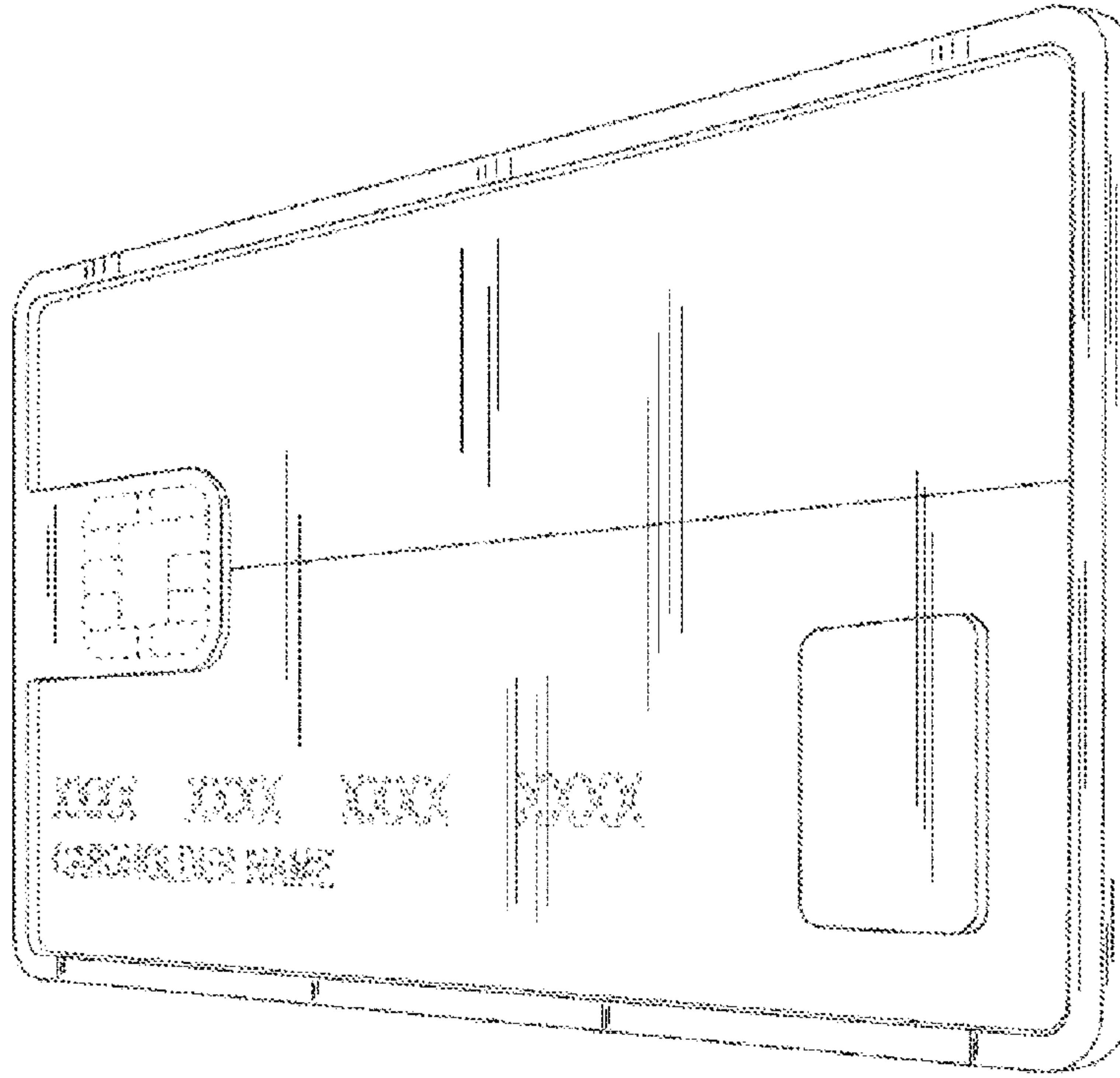

FIG. 15

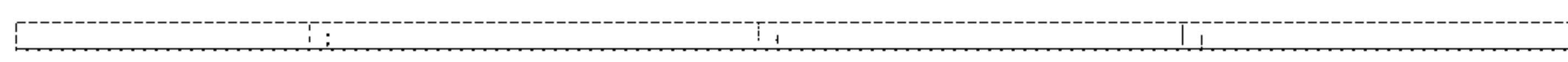

FIG. 17

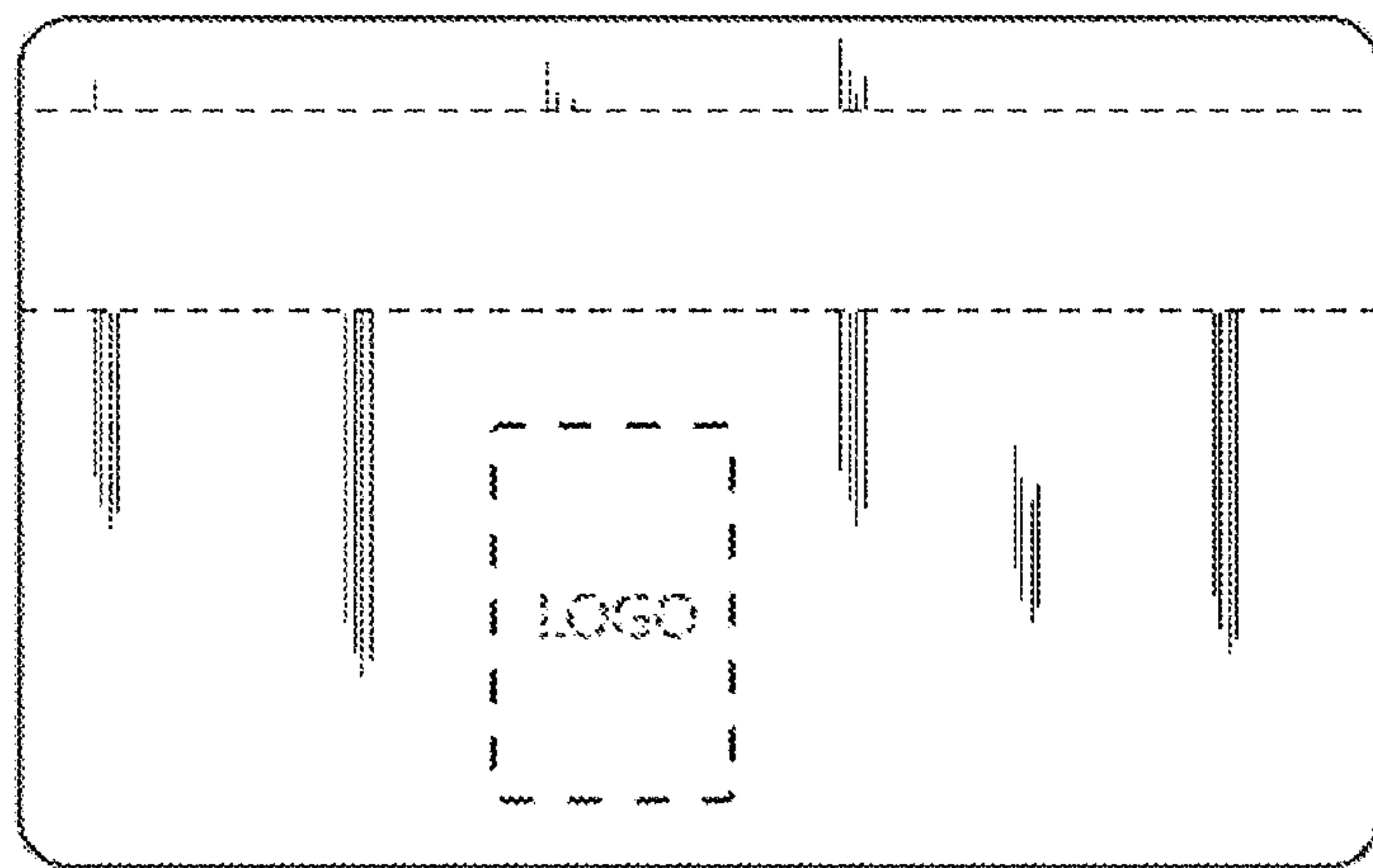

FIG. 16



FIG. 18

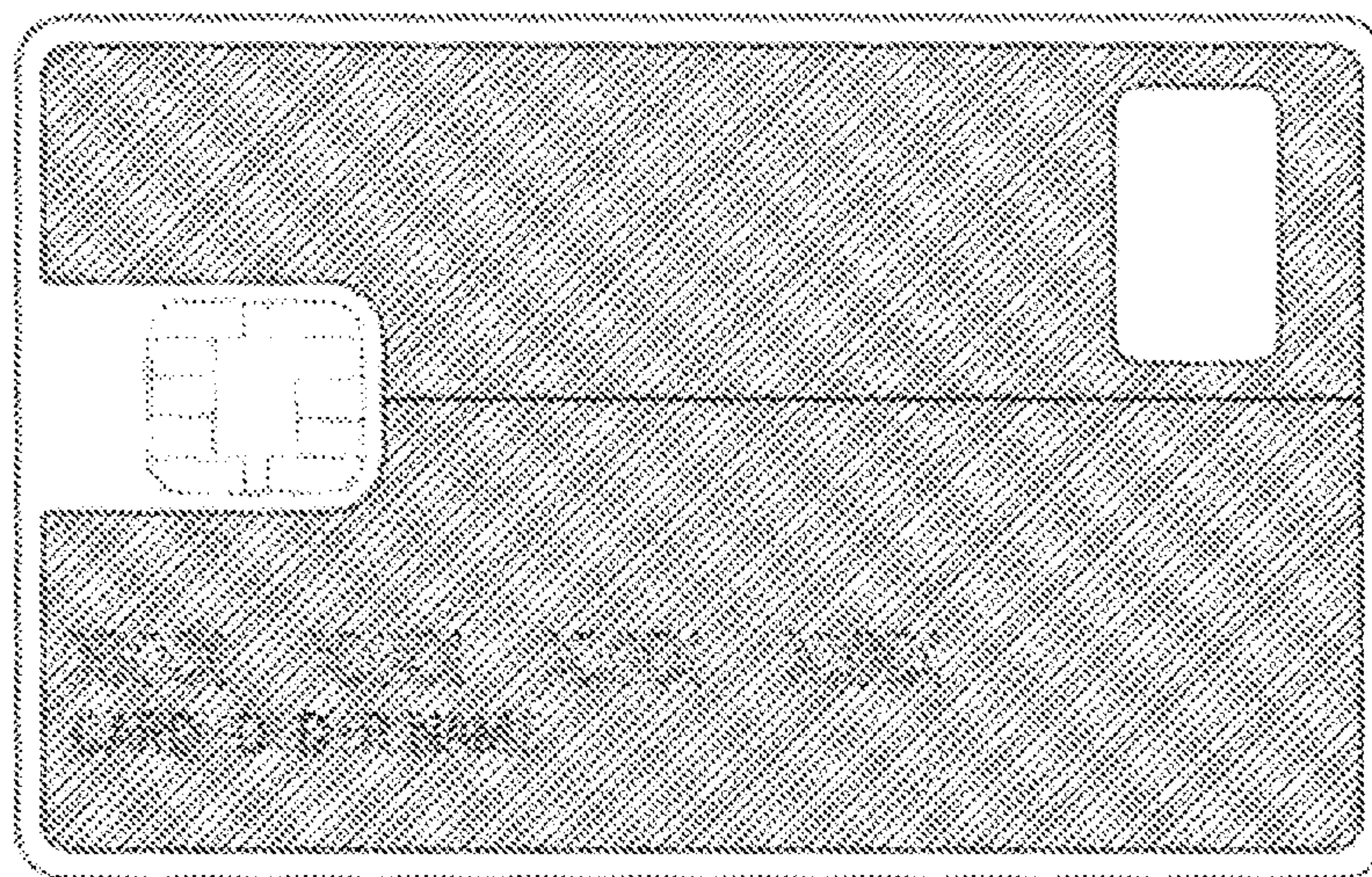

FIG. 19

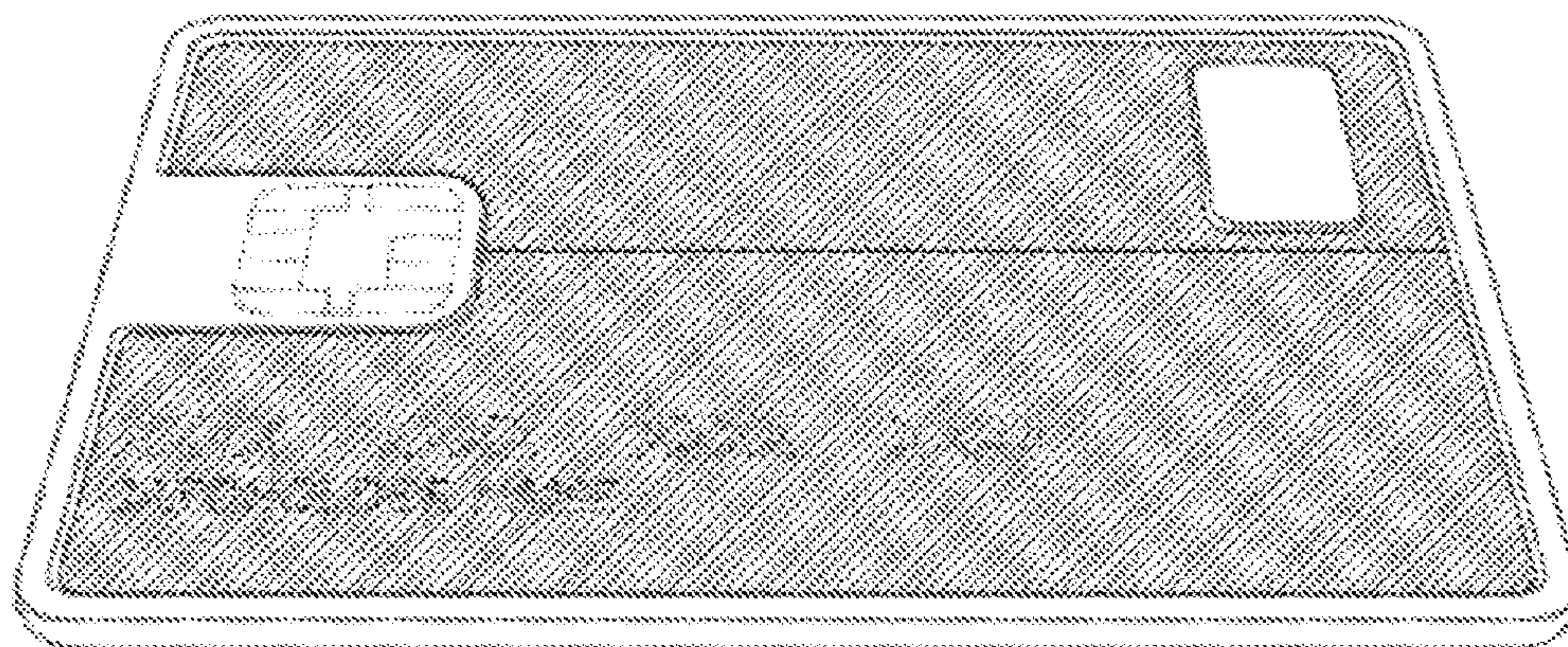

FIG. 20

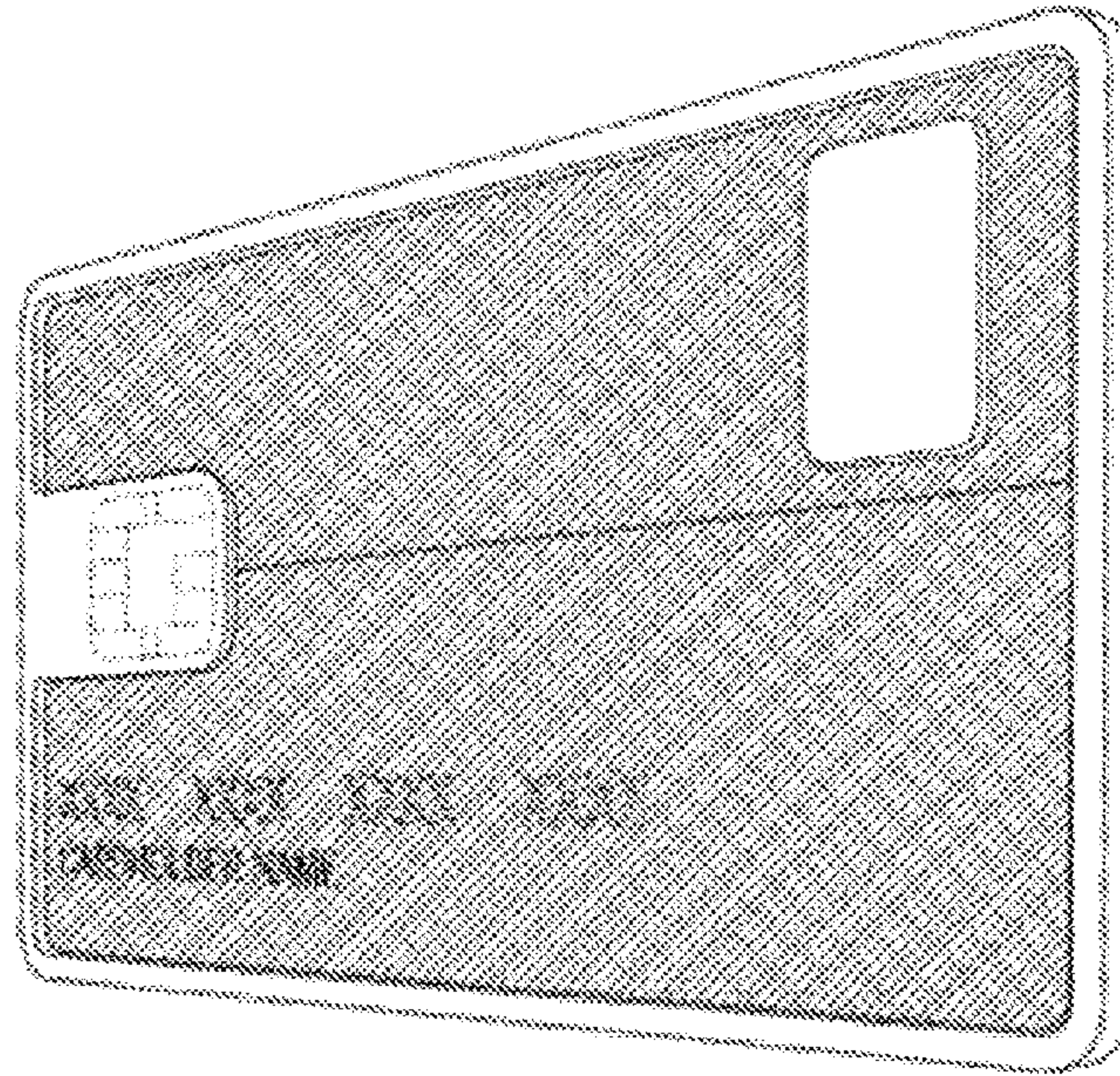

FIG. 21

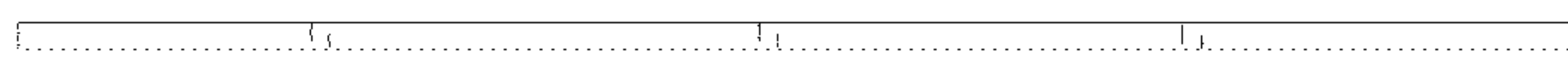

FIG. 23

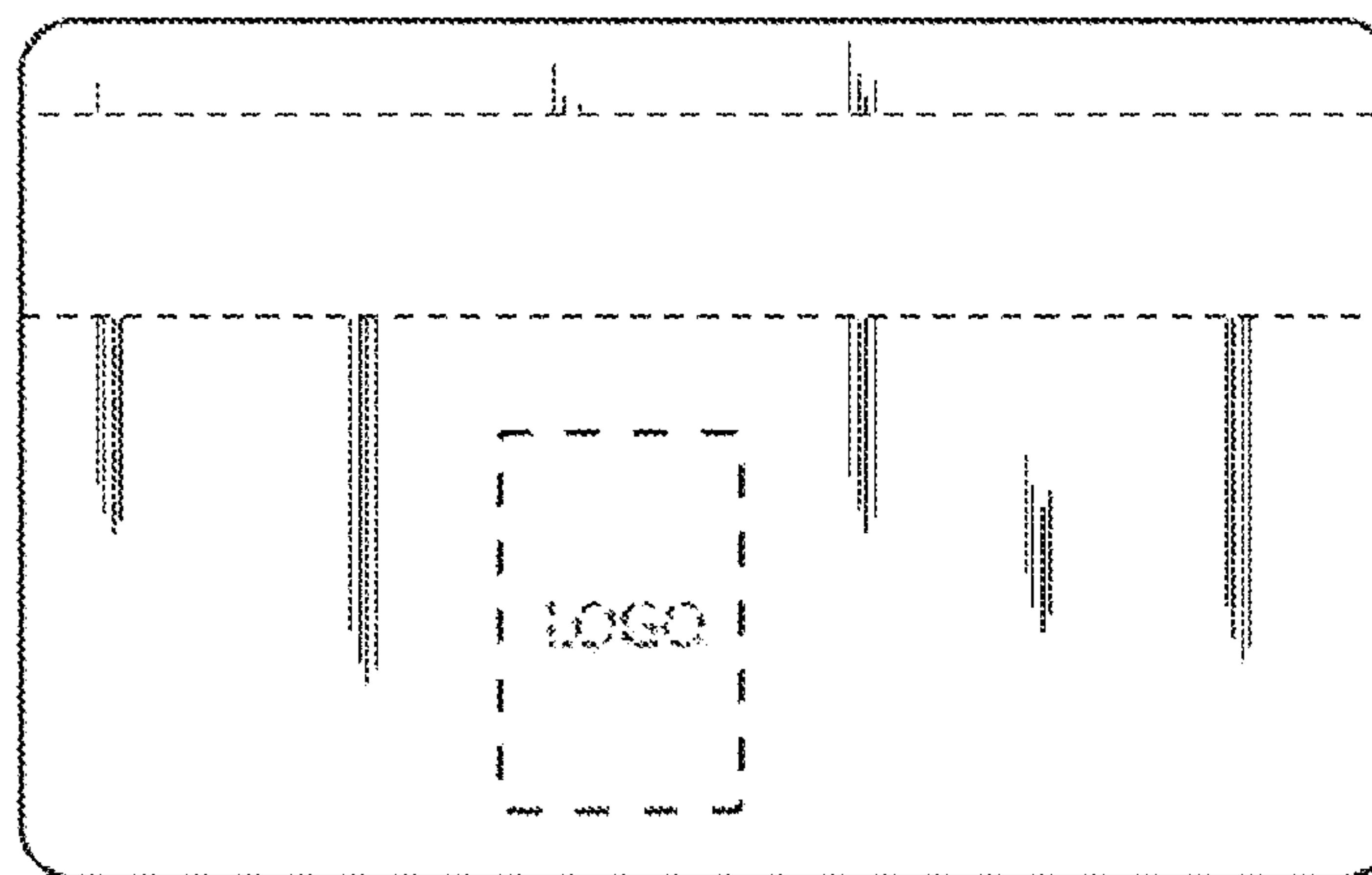

FIG. 22



FIG. 24

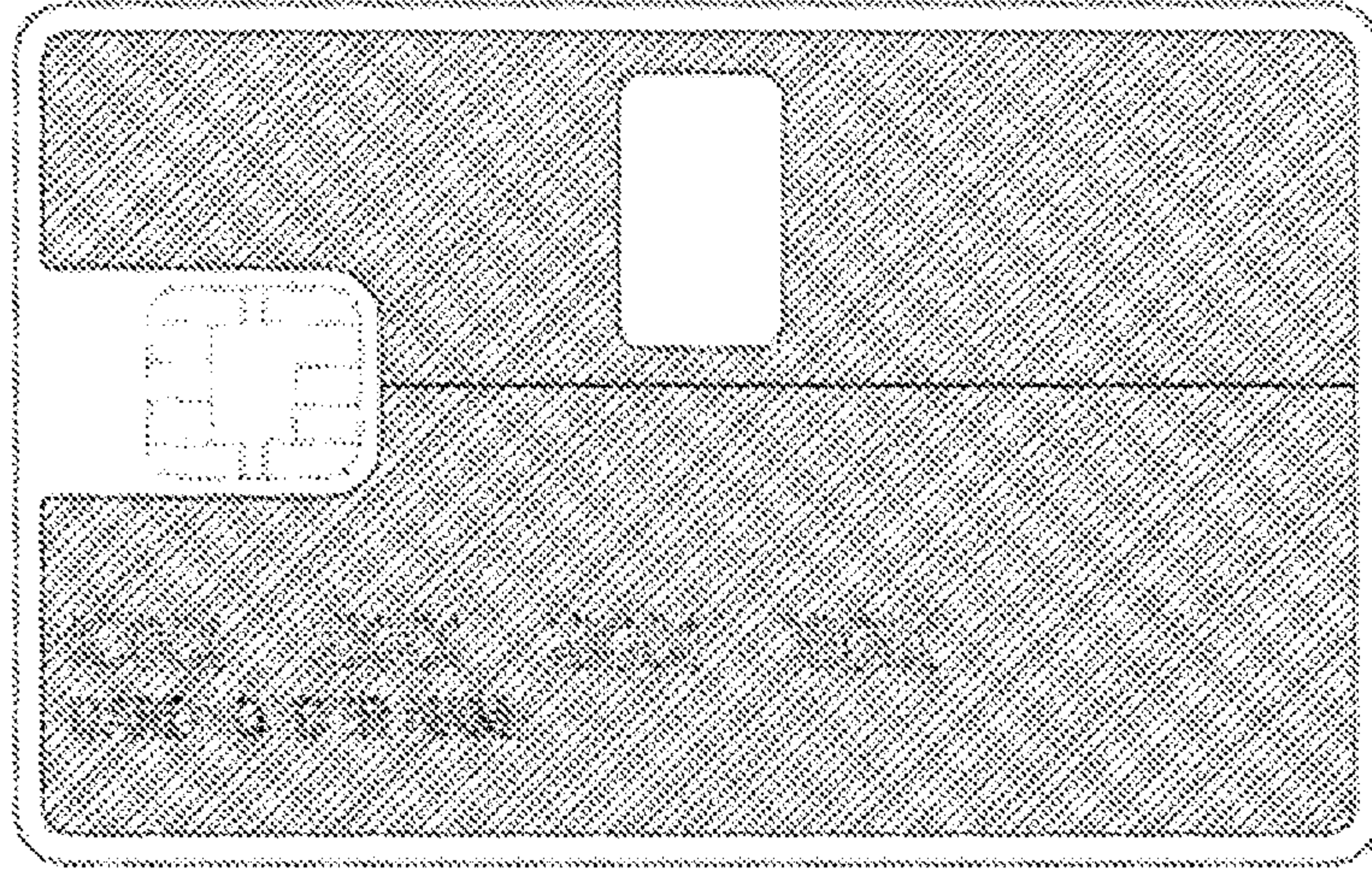

FIG. 25

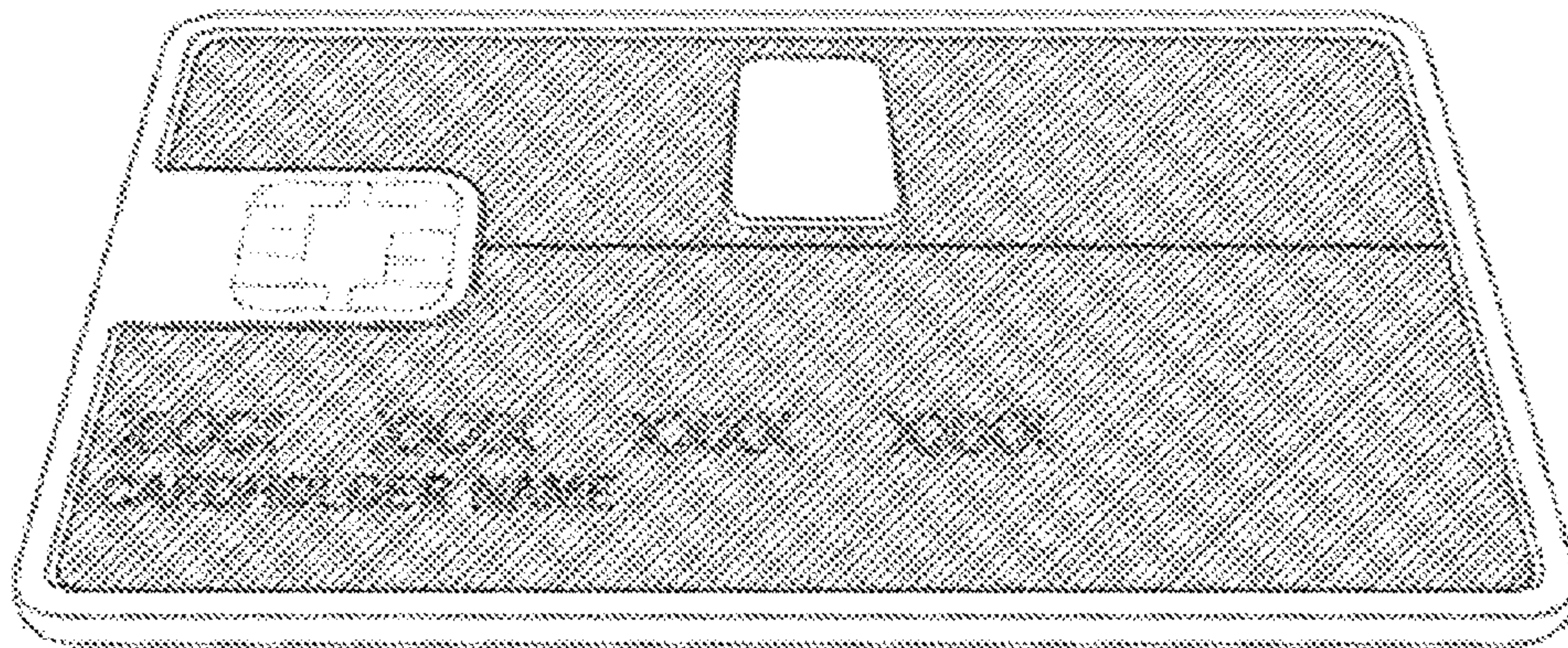

FIG. 26

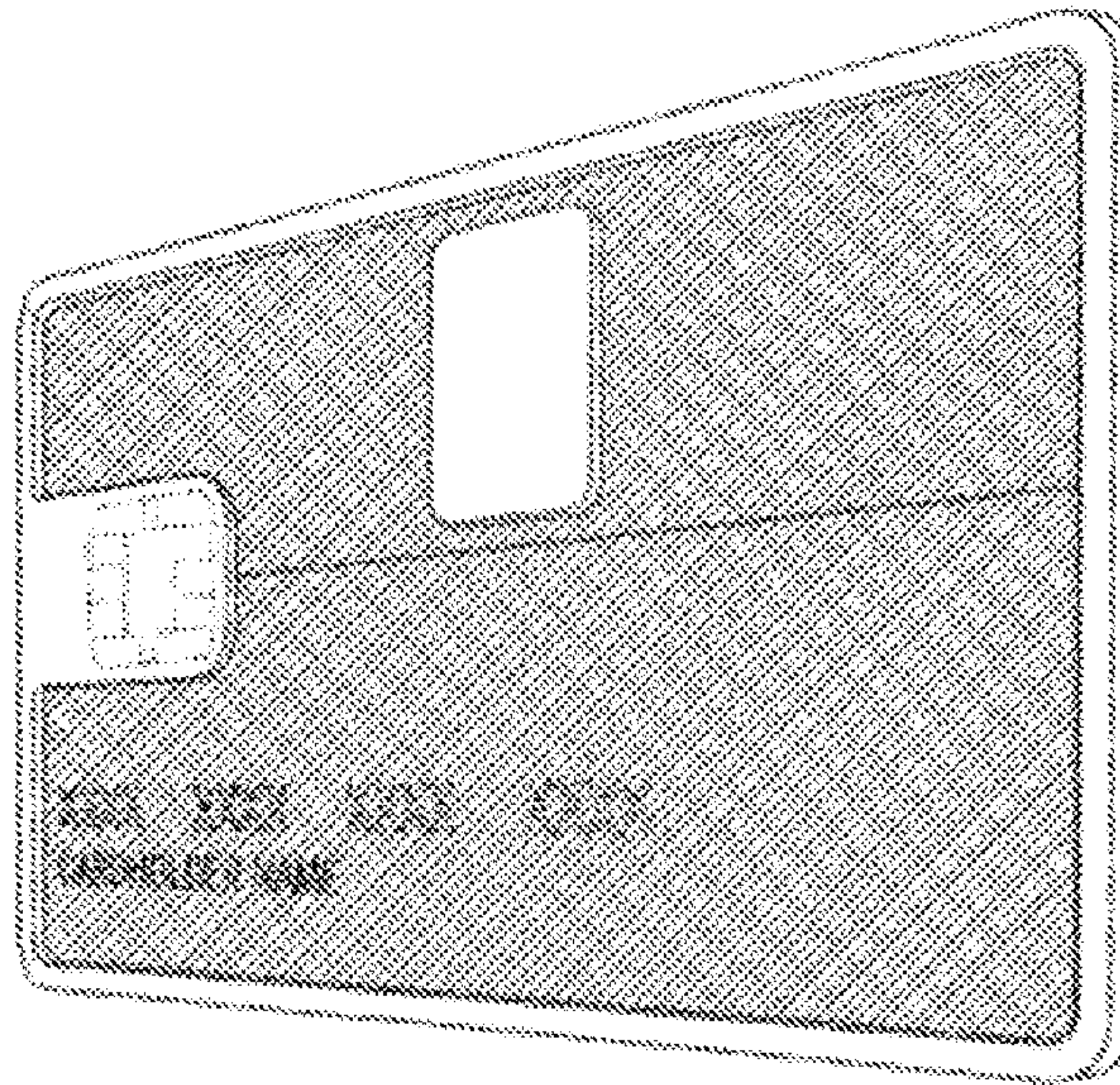

FIG. 27

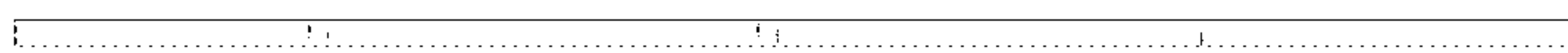

FIG. 29

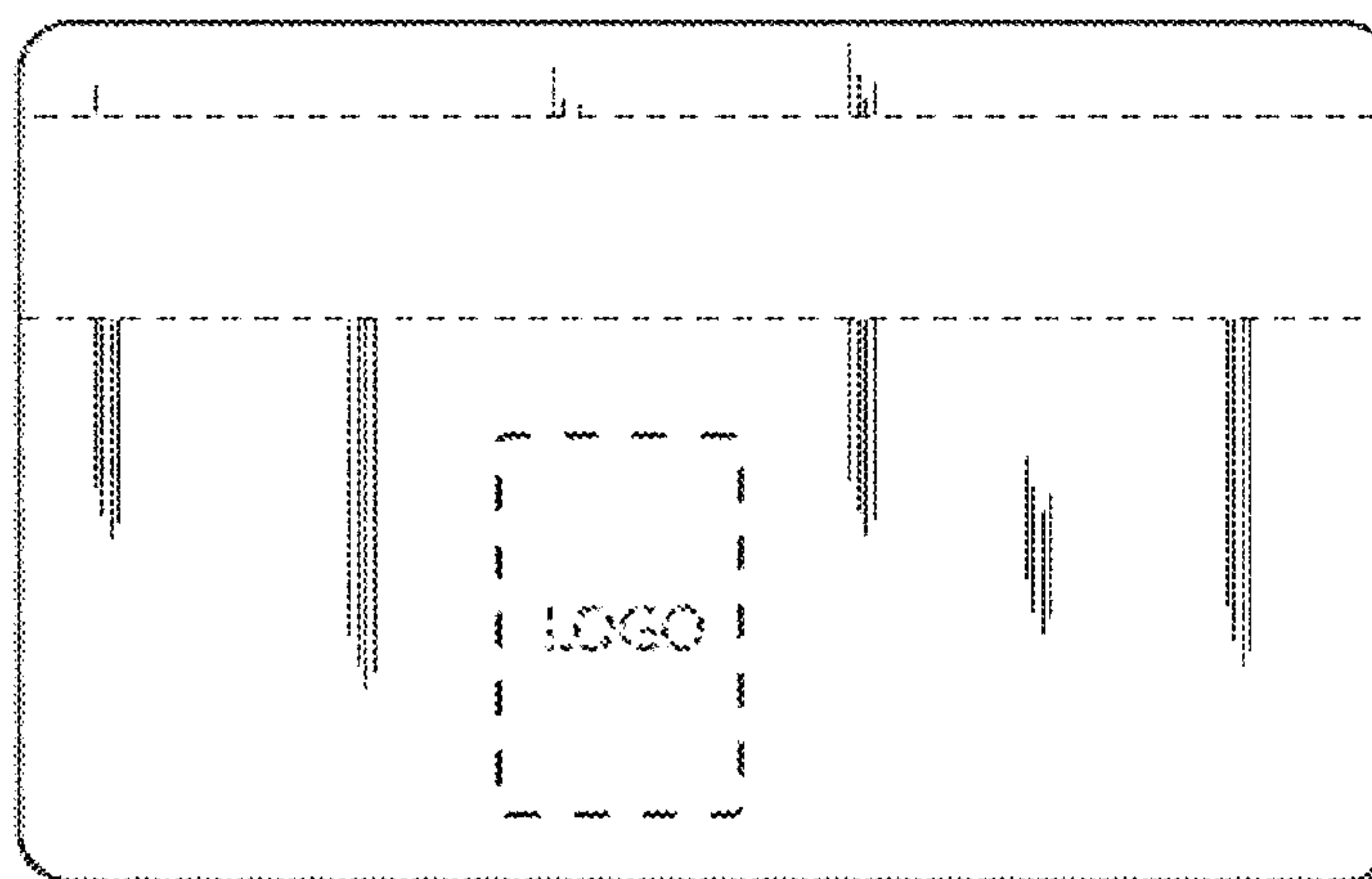

FIG. 28



FIG. 30

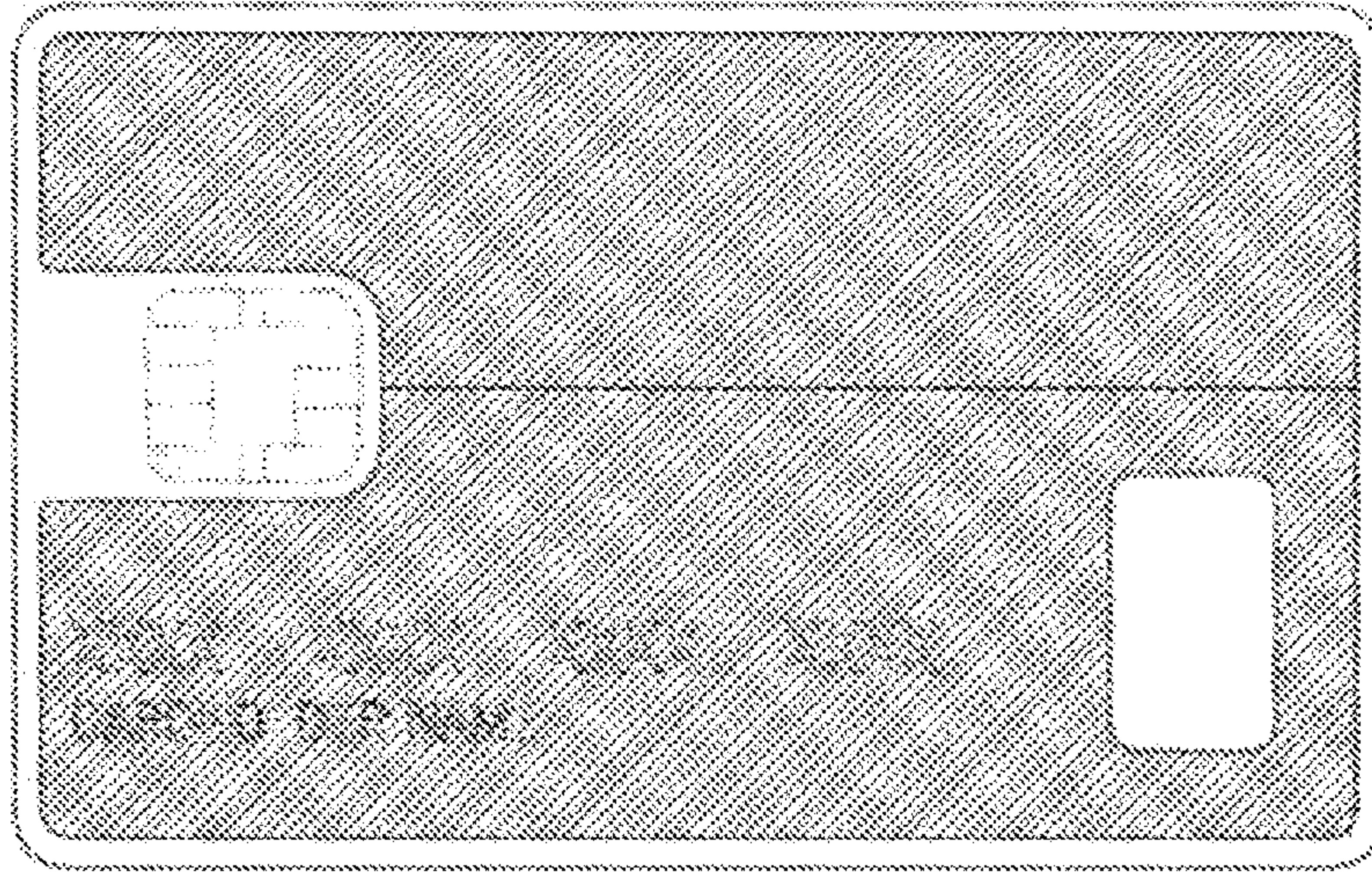

FIG. 31

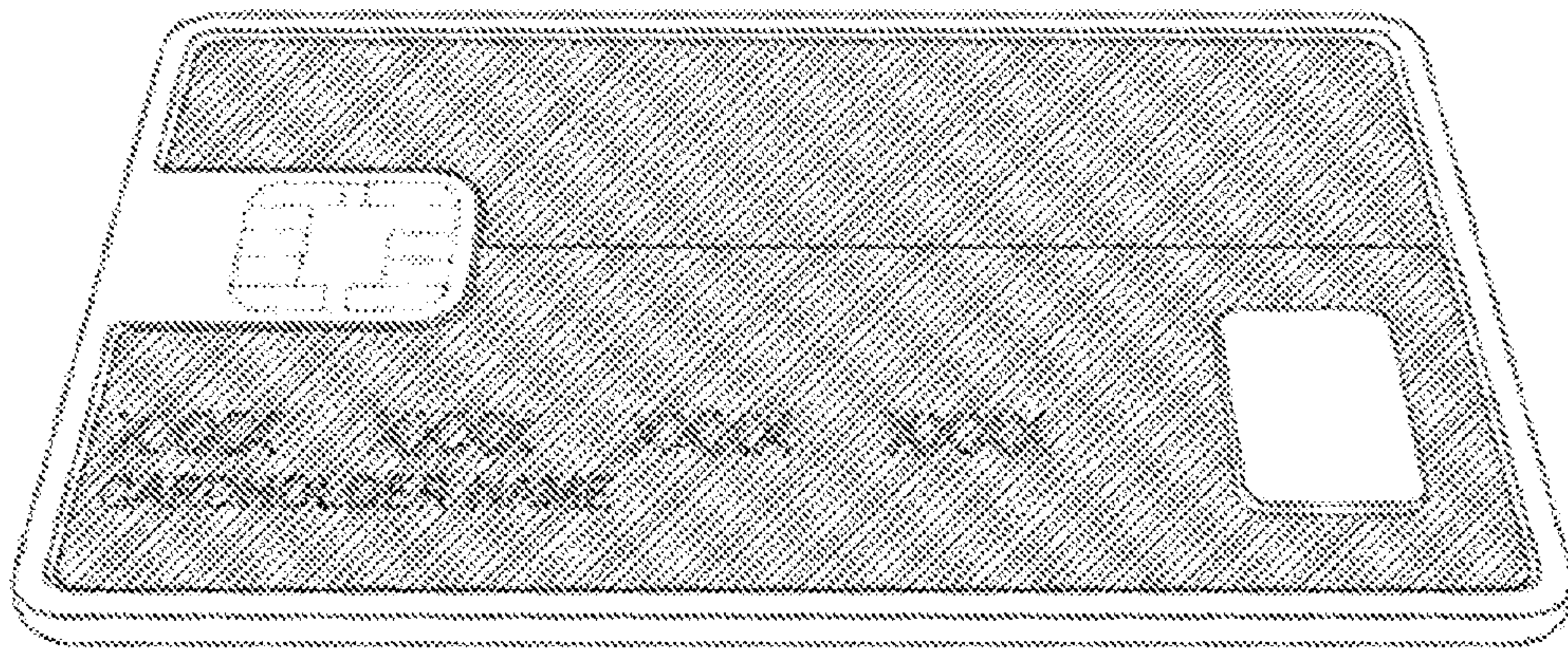

FIG. 32

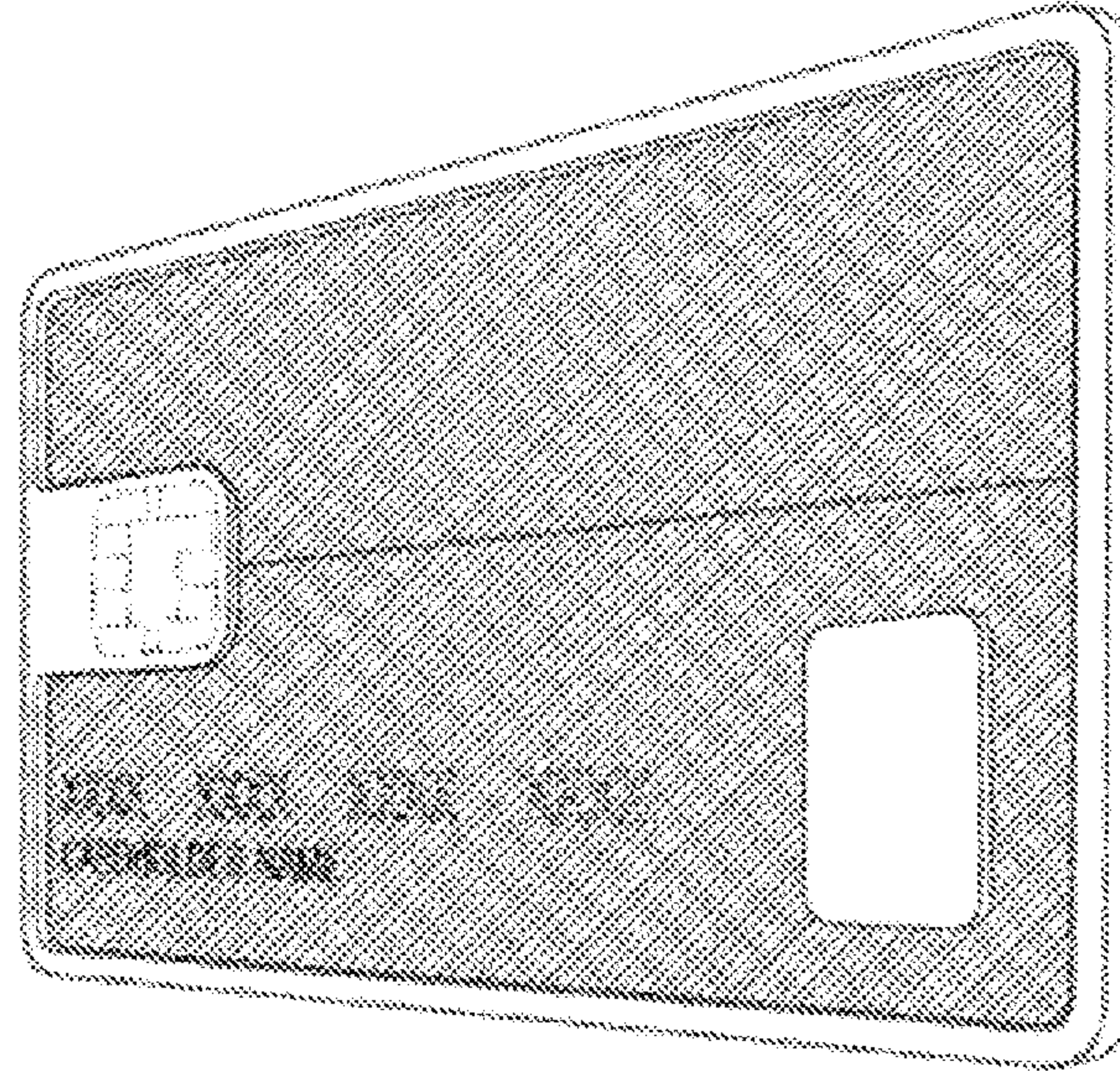

FIG. 33



FIG. 35

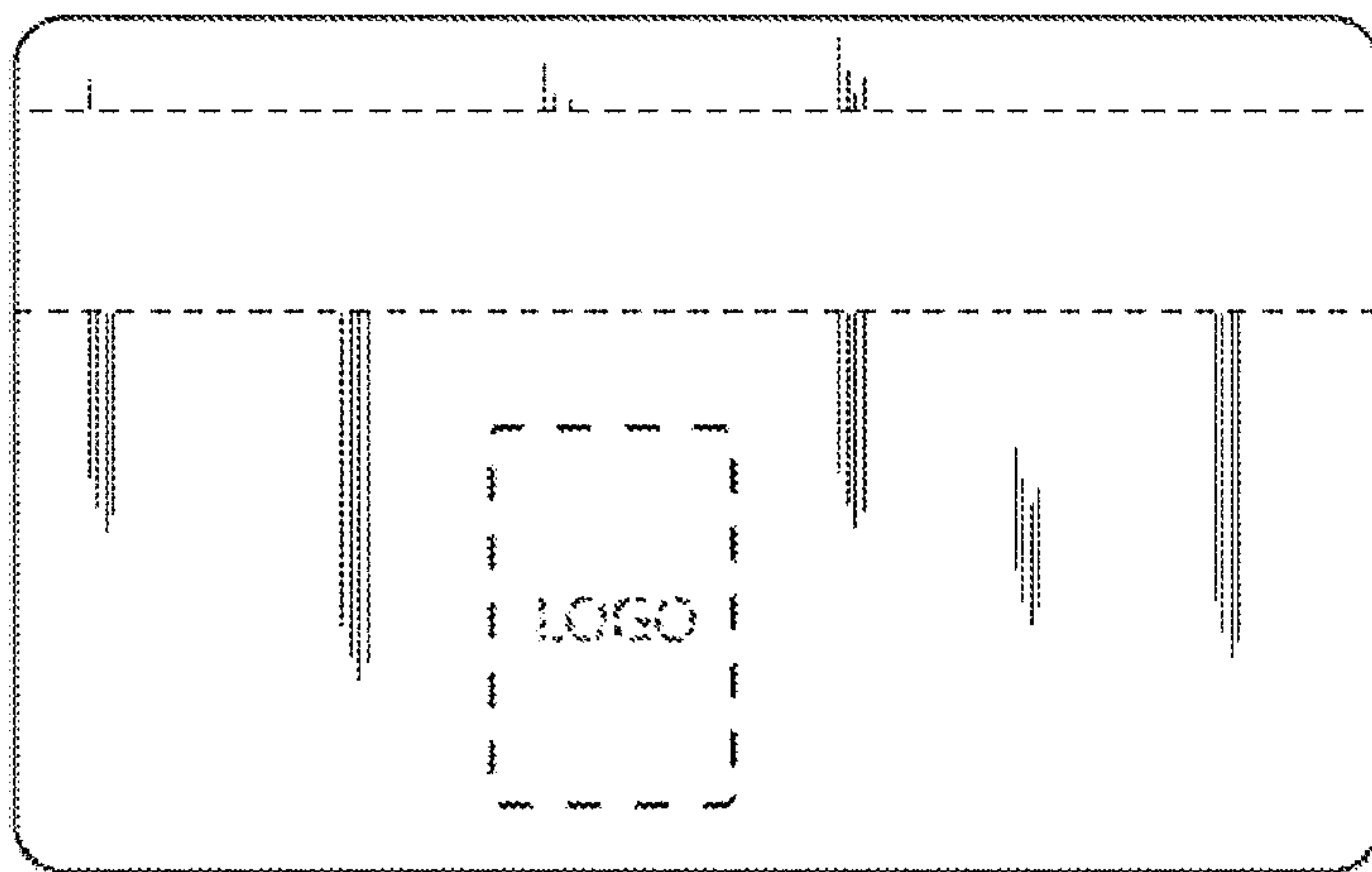

FIG. 34



FIG. 36

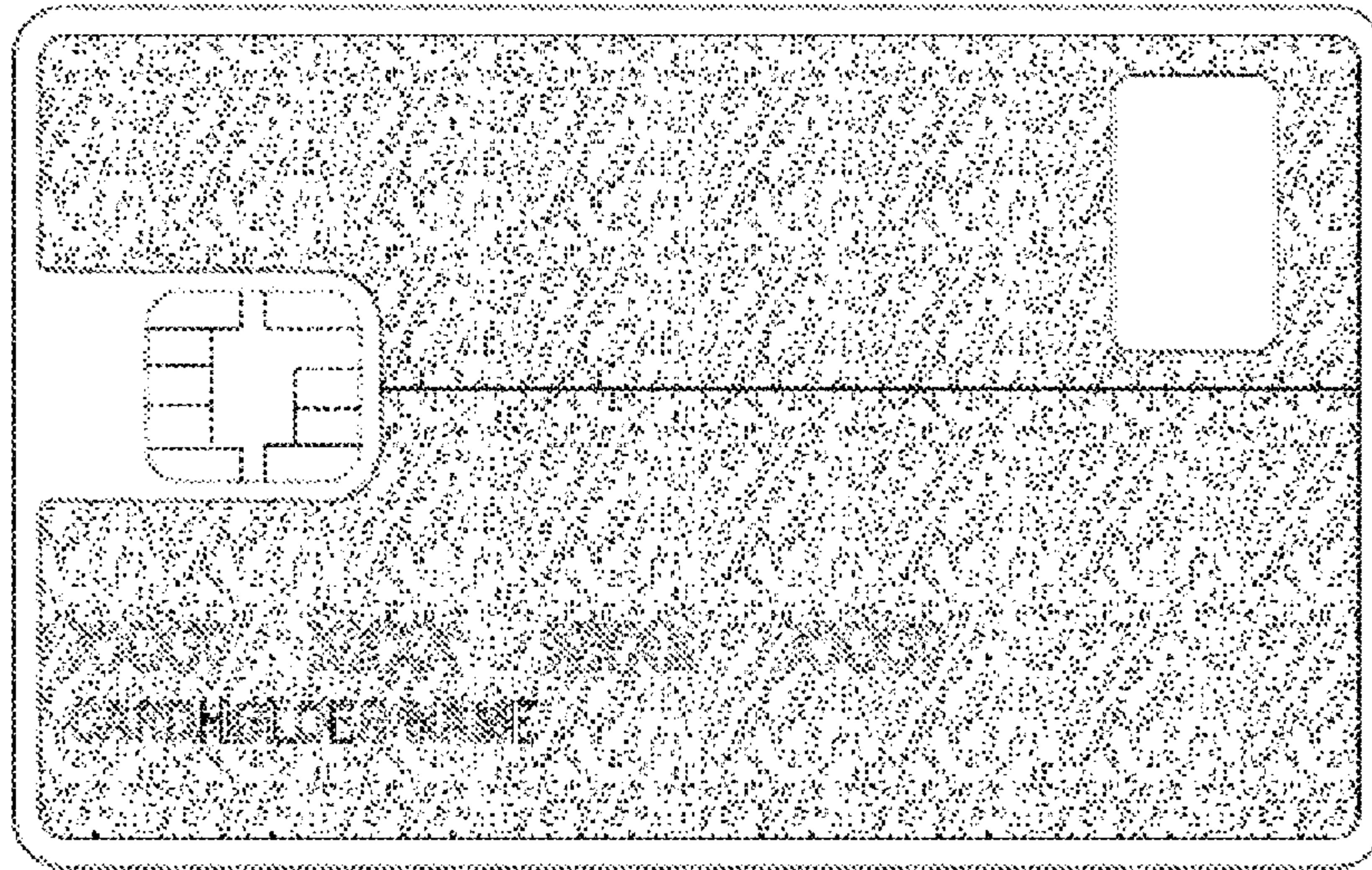

FIG. 37

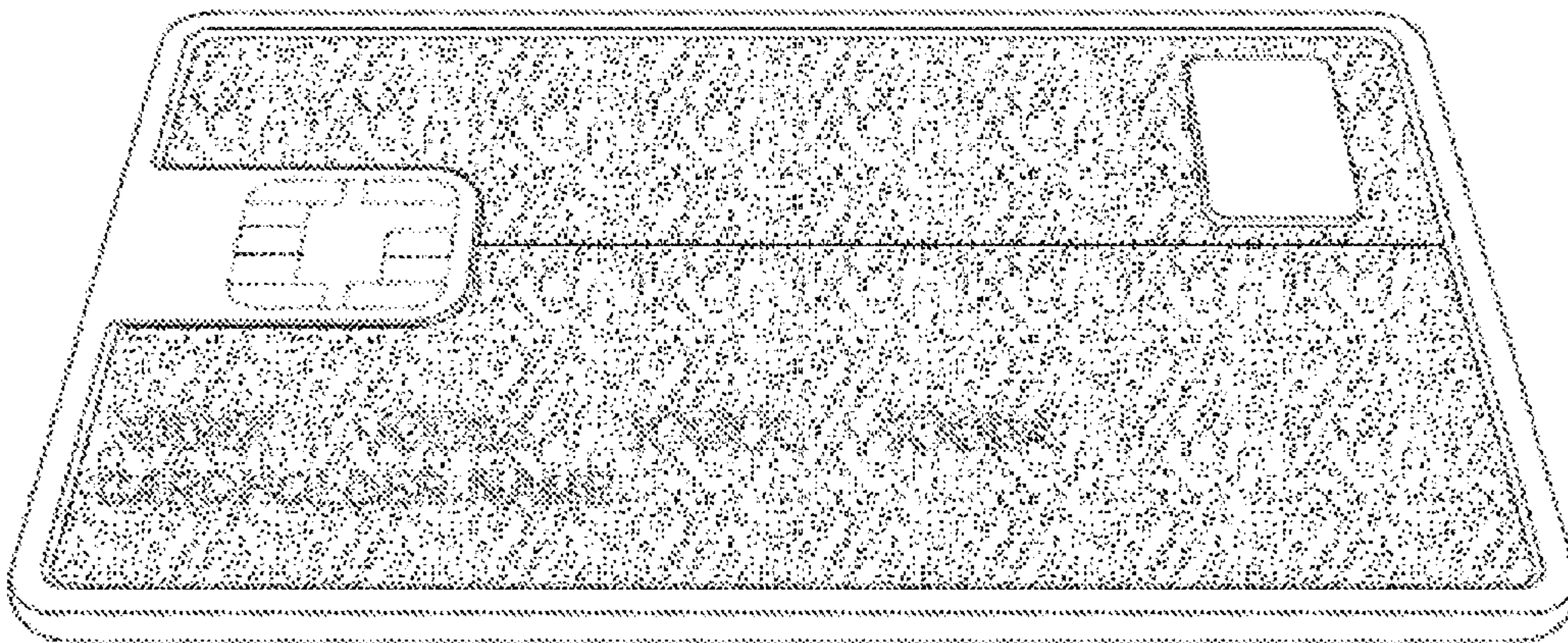

FIG. 38

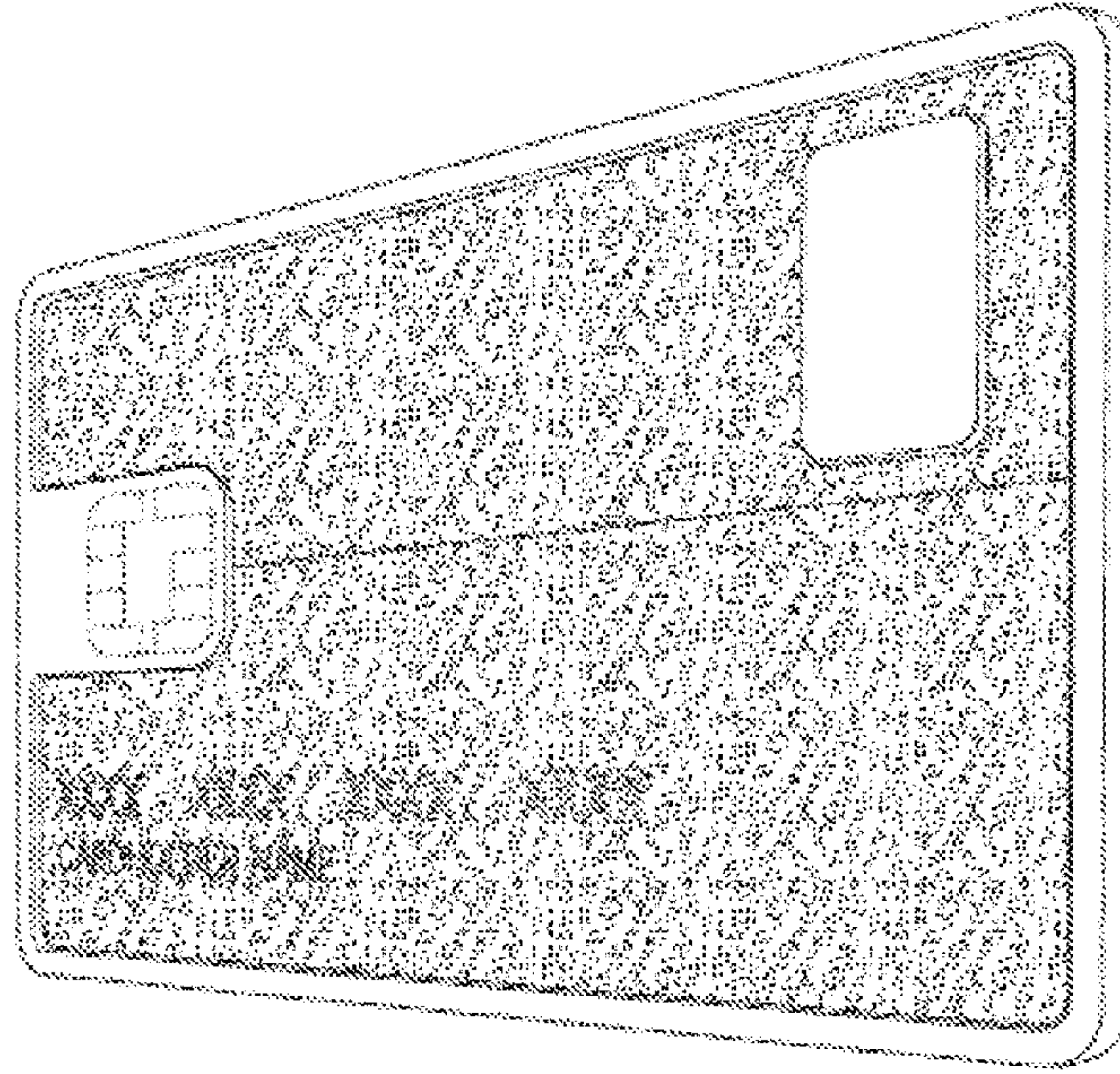

FIG. 39

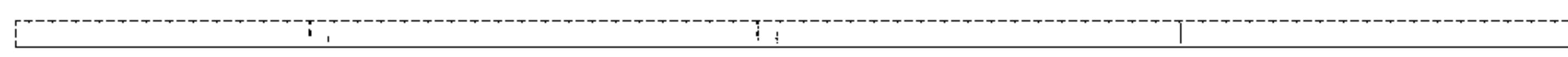

FIG.41

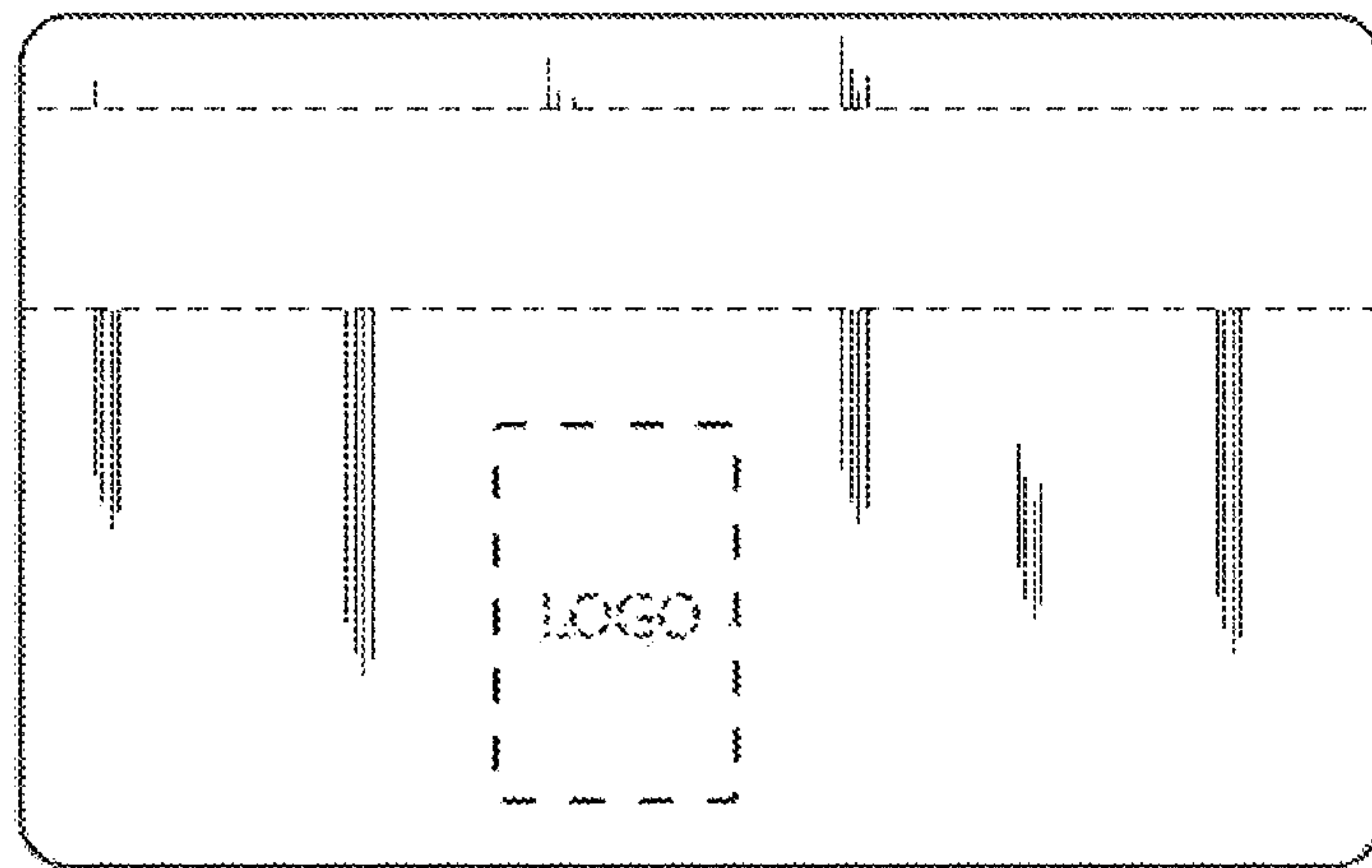

FIG. 40

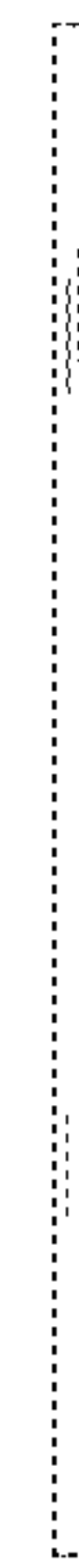

FIG.42

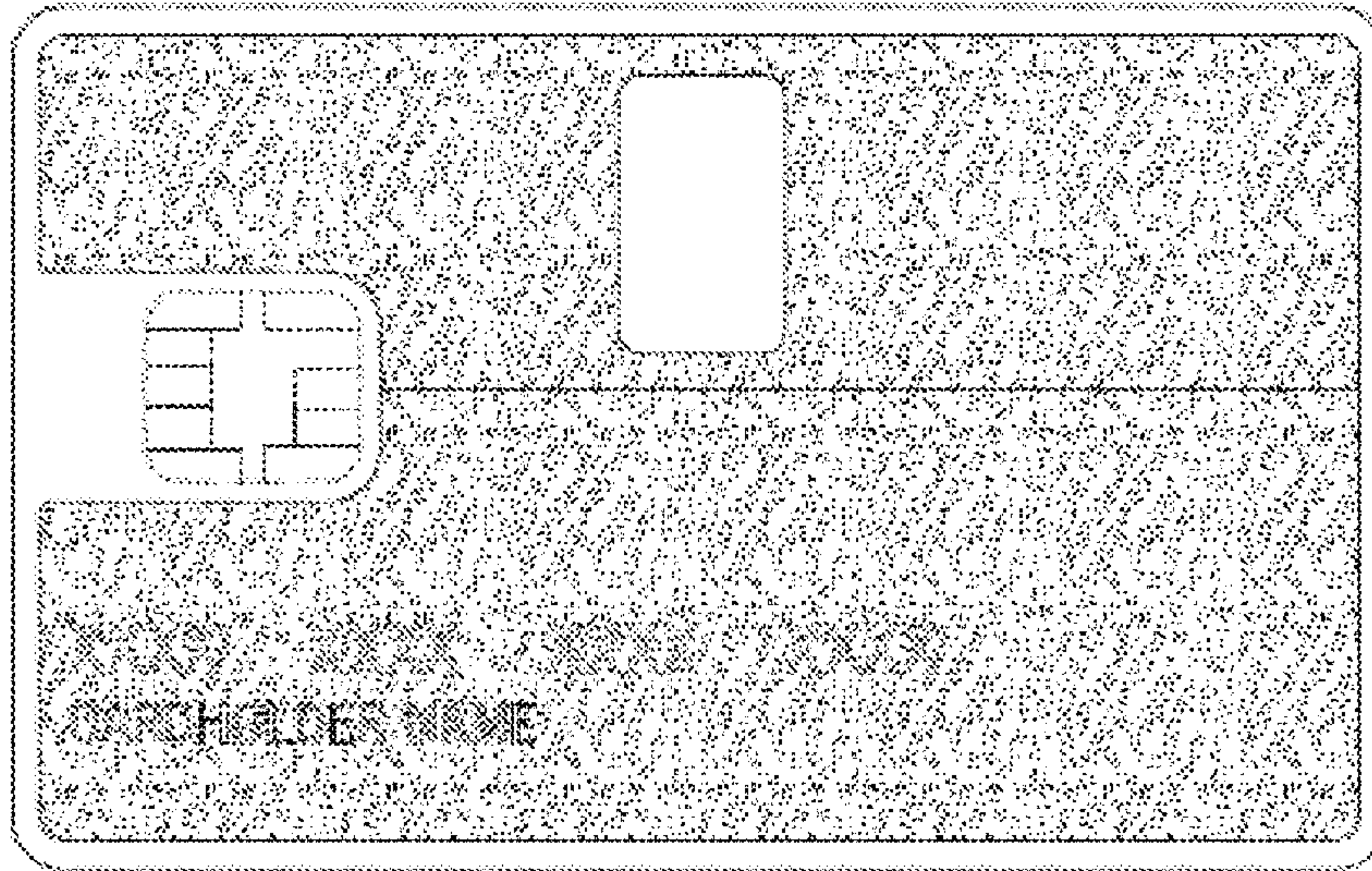

FIG. 43

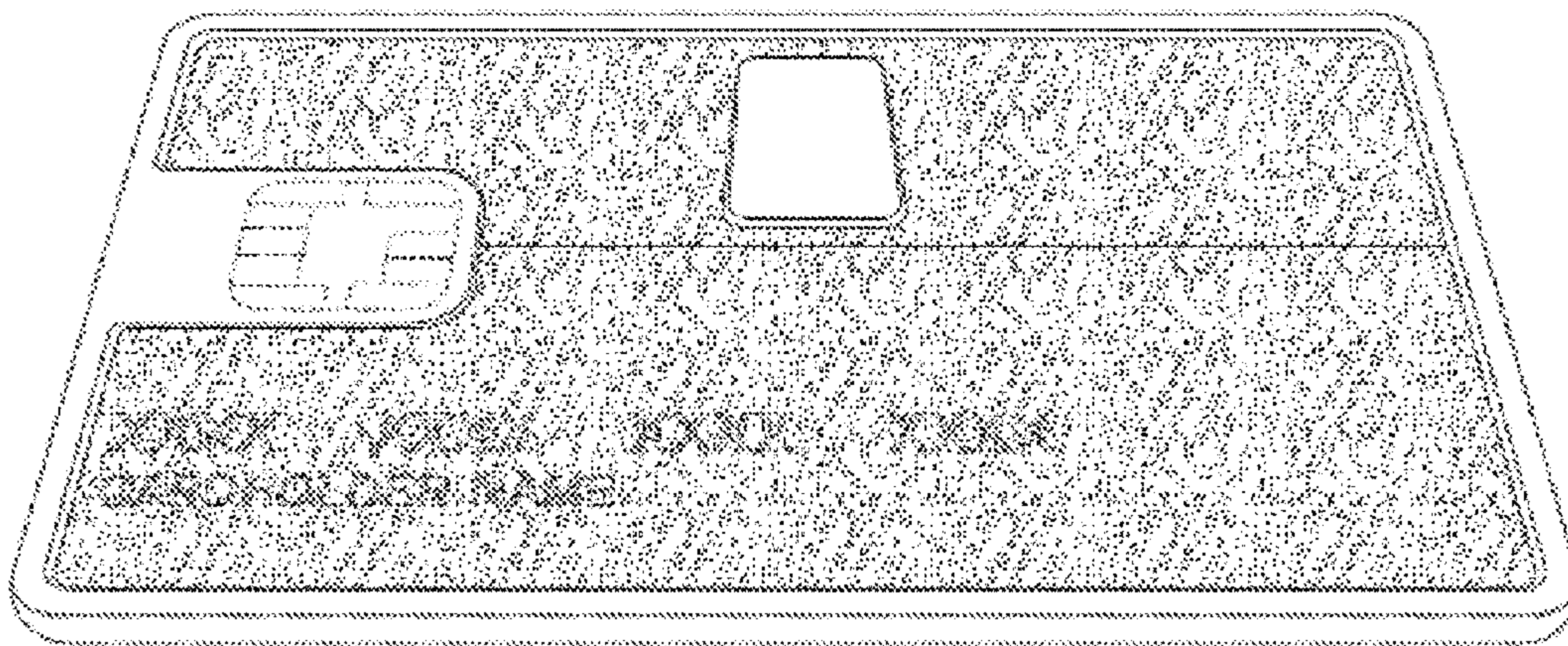

FIG. 44

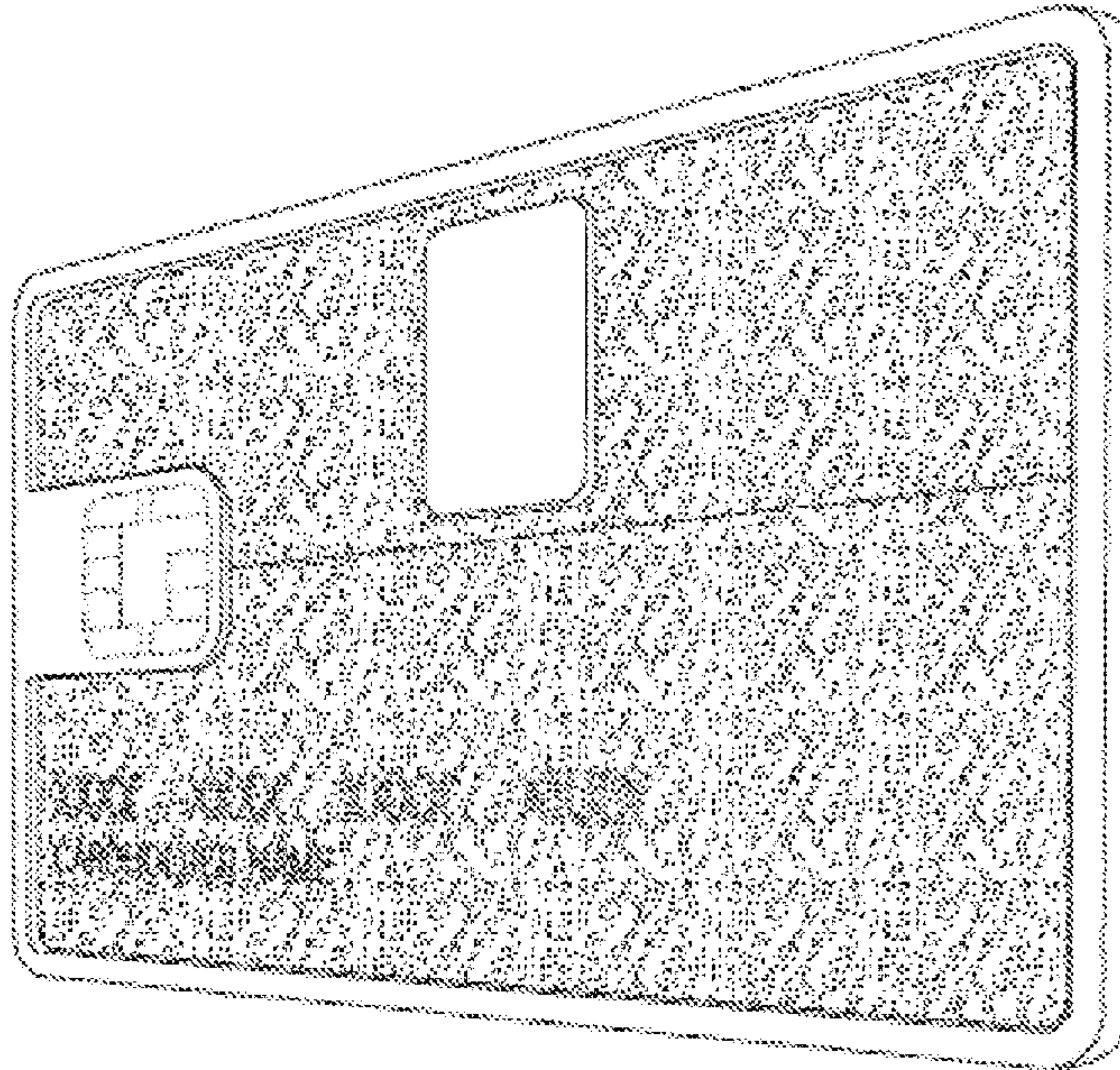

FIG. 45



FIG. 47

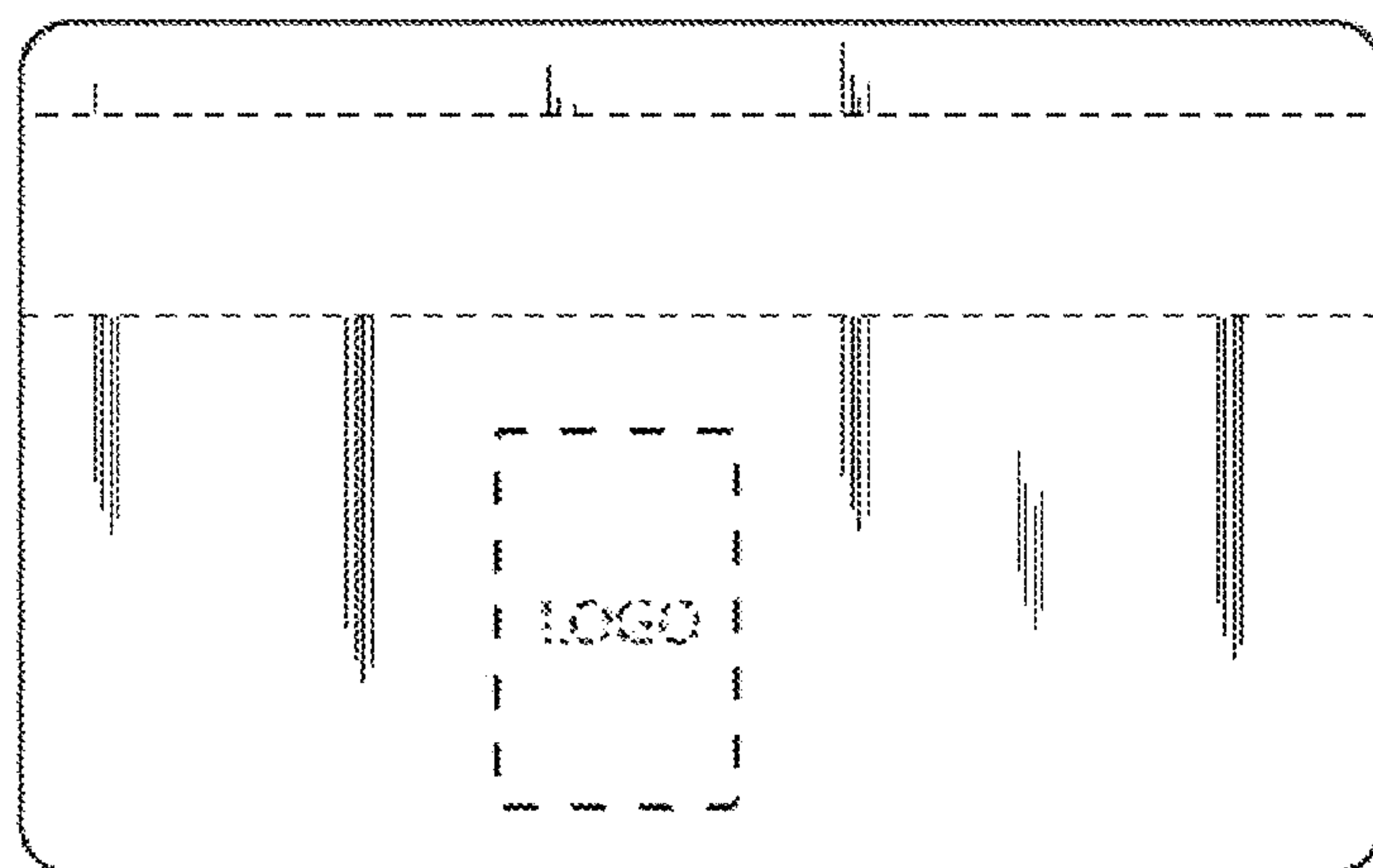

FIG. 46



FIG. 48

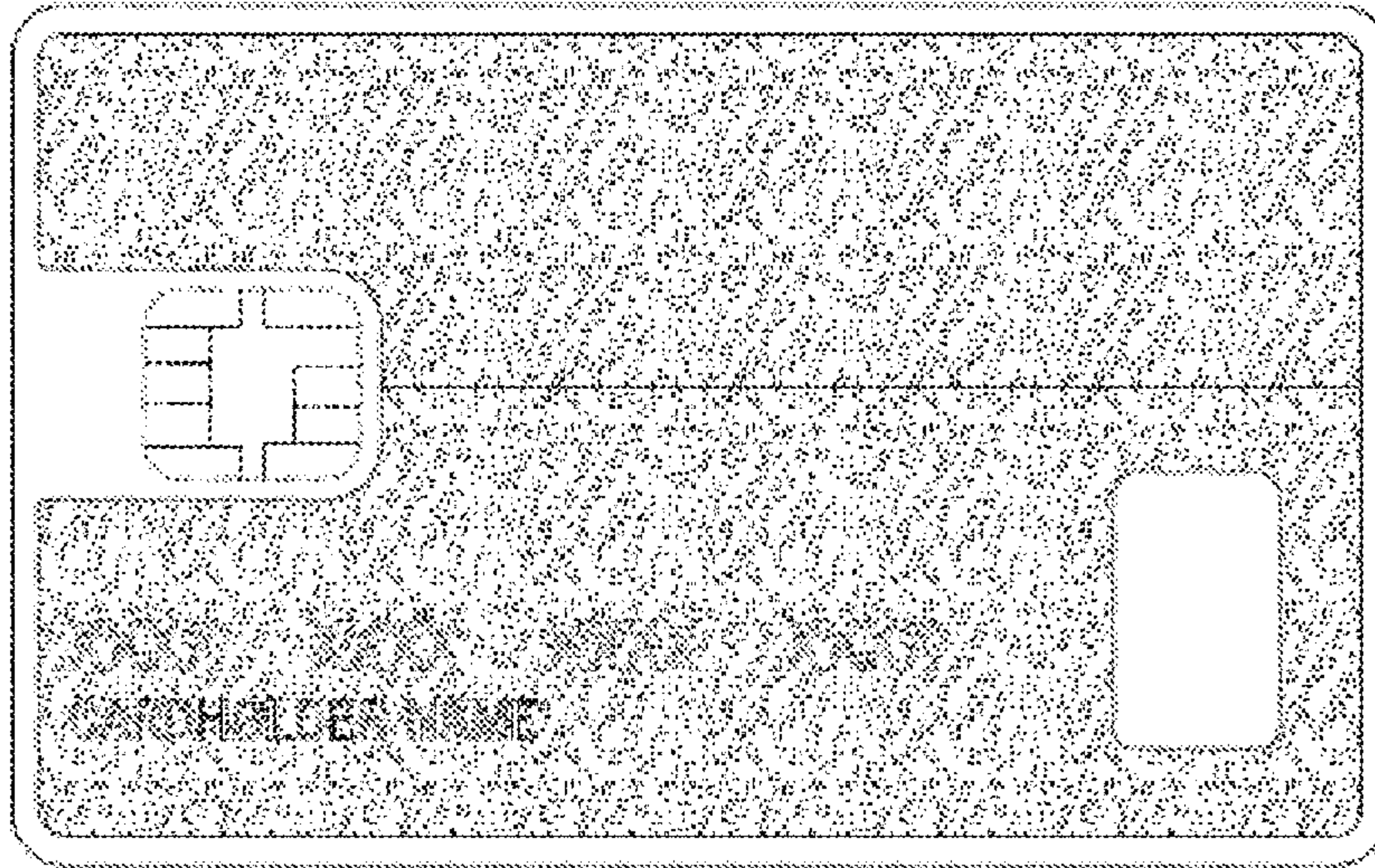

FIG. 49

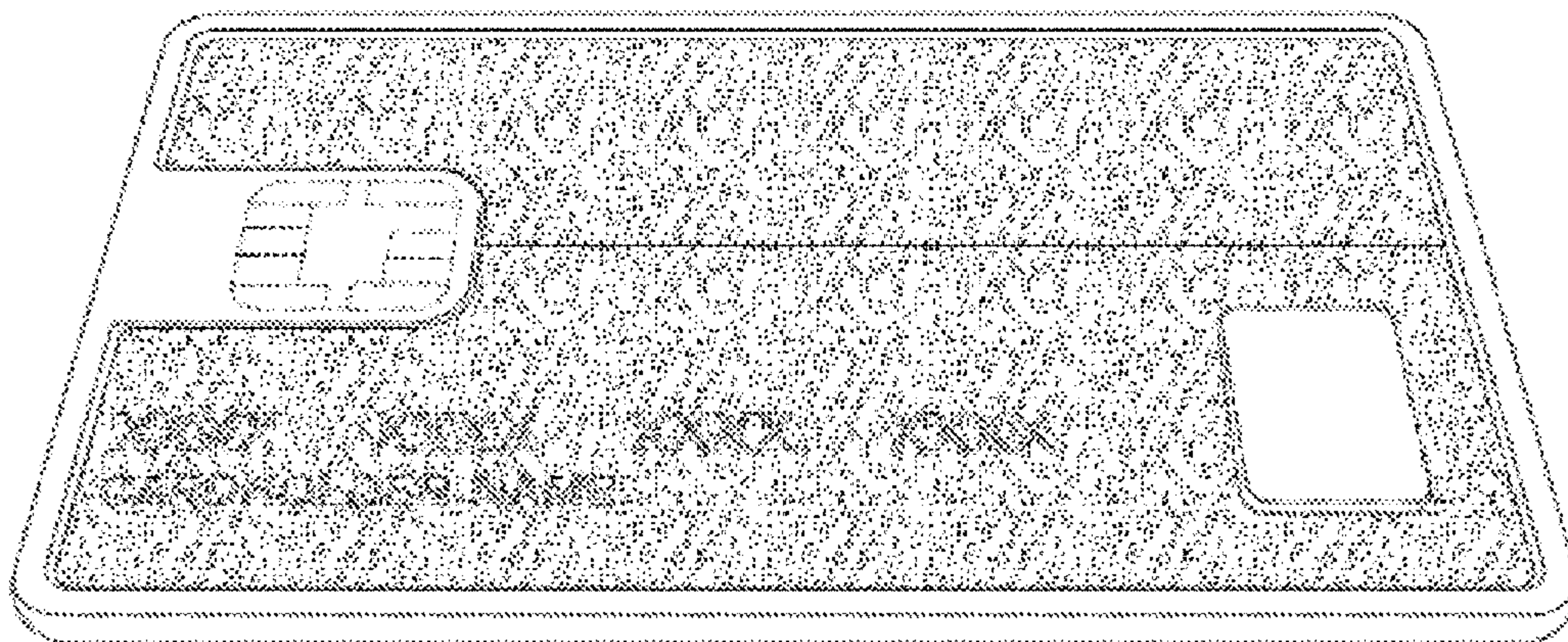

FIG. 50

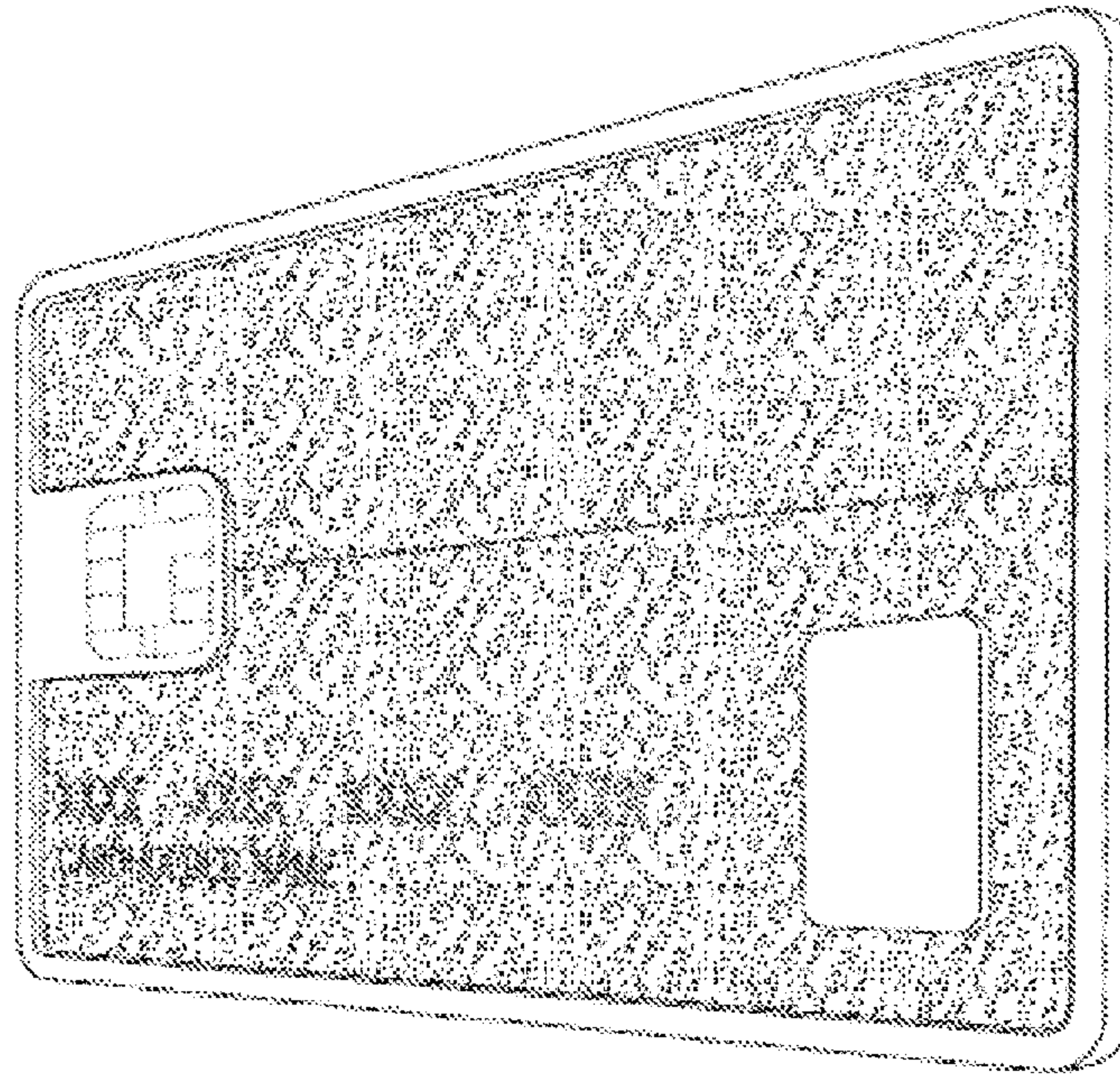

FIG. 51

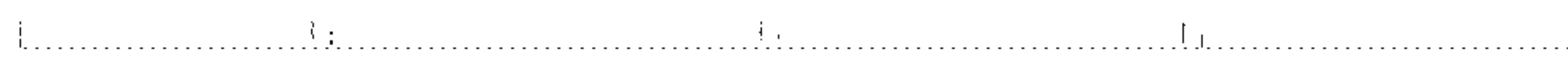

FIG. 53

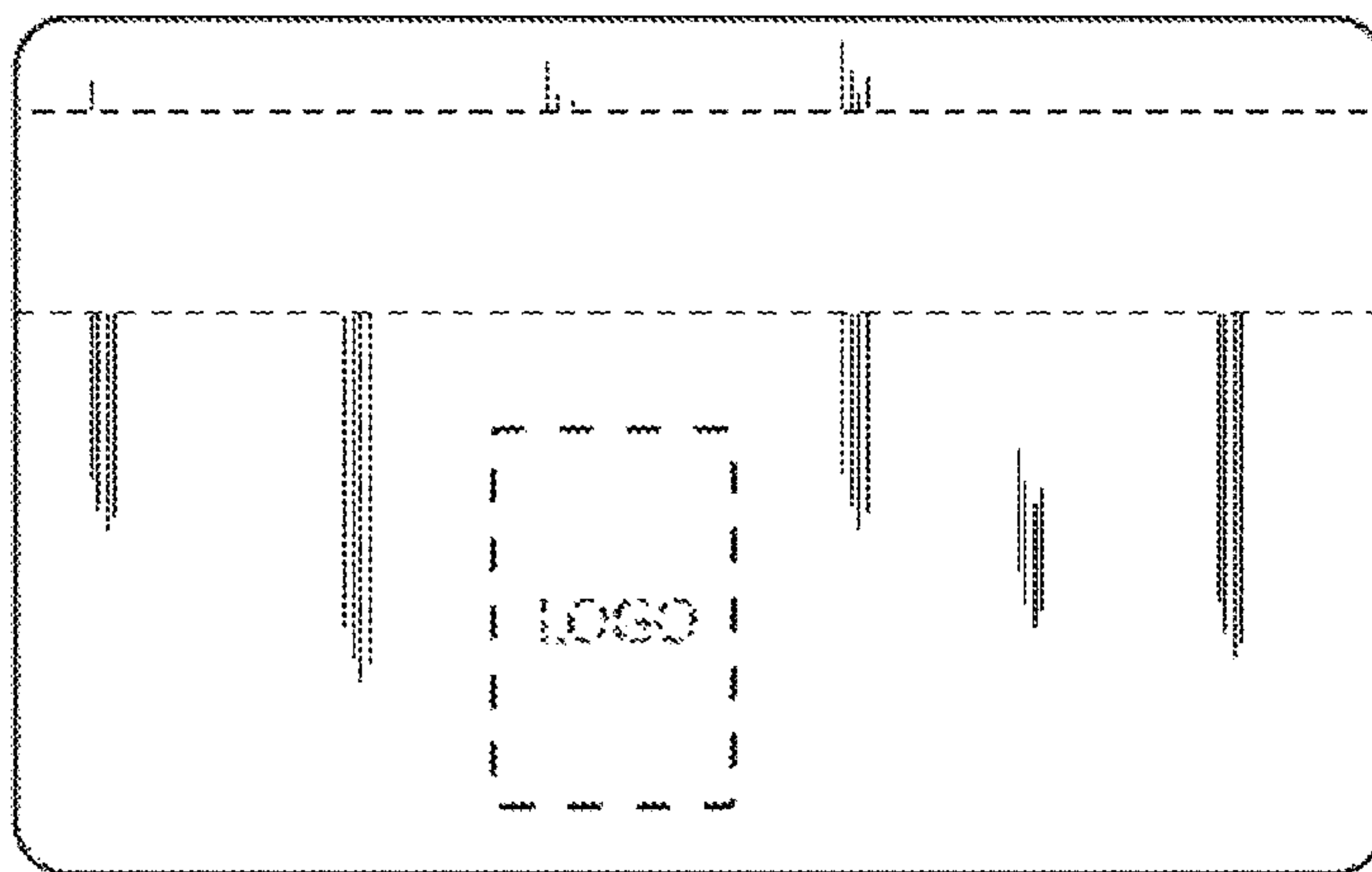

FIG. 52



FIG. 54

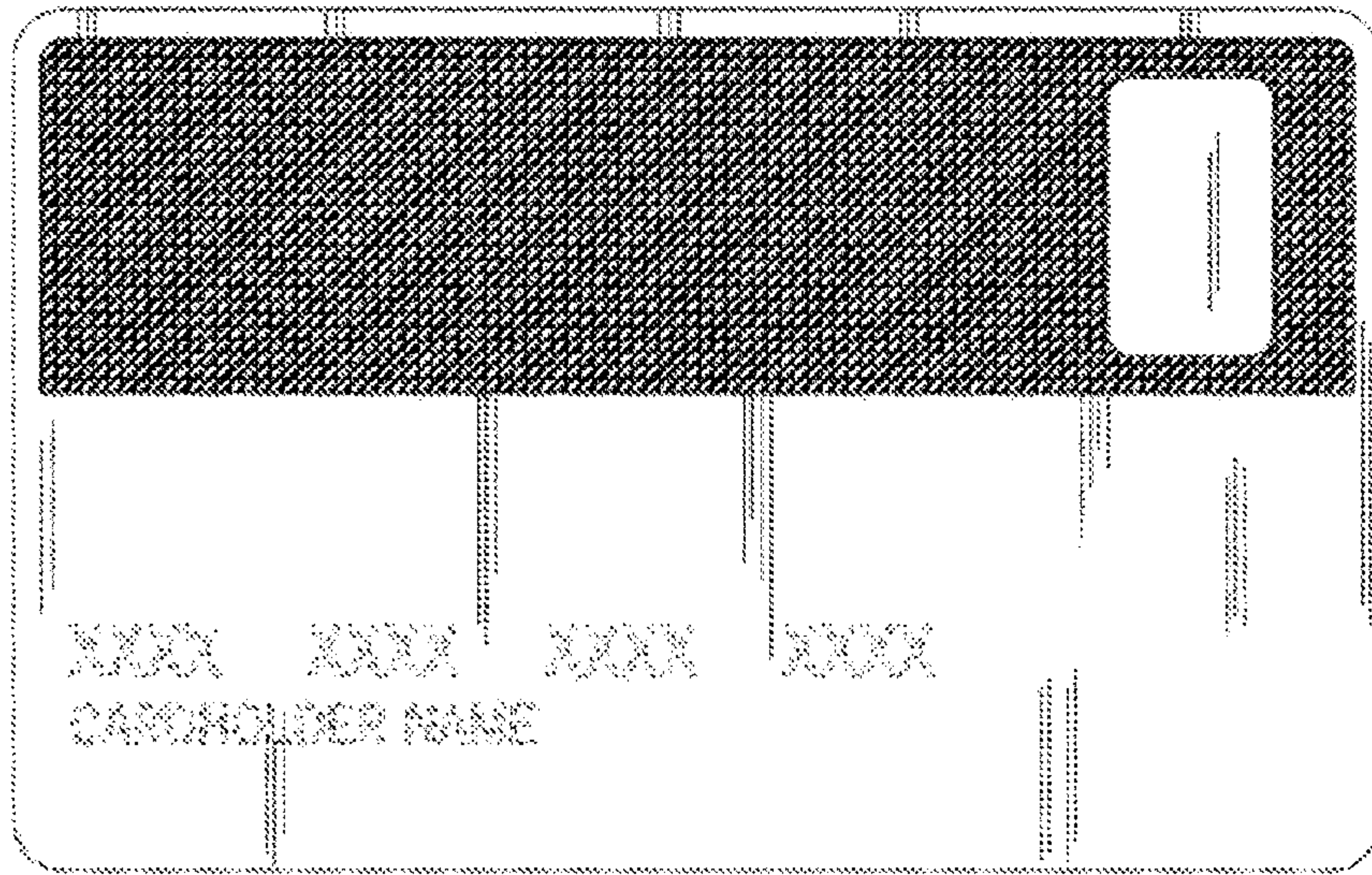

FIG. 55

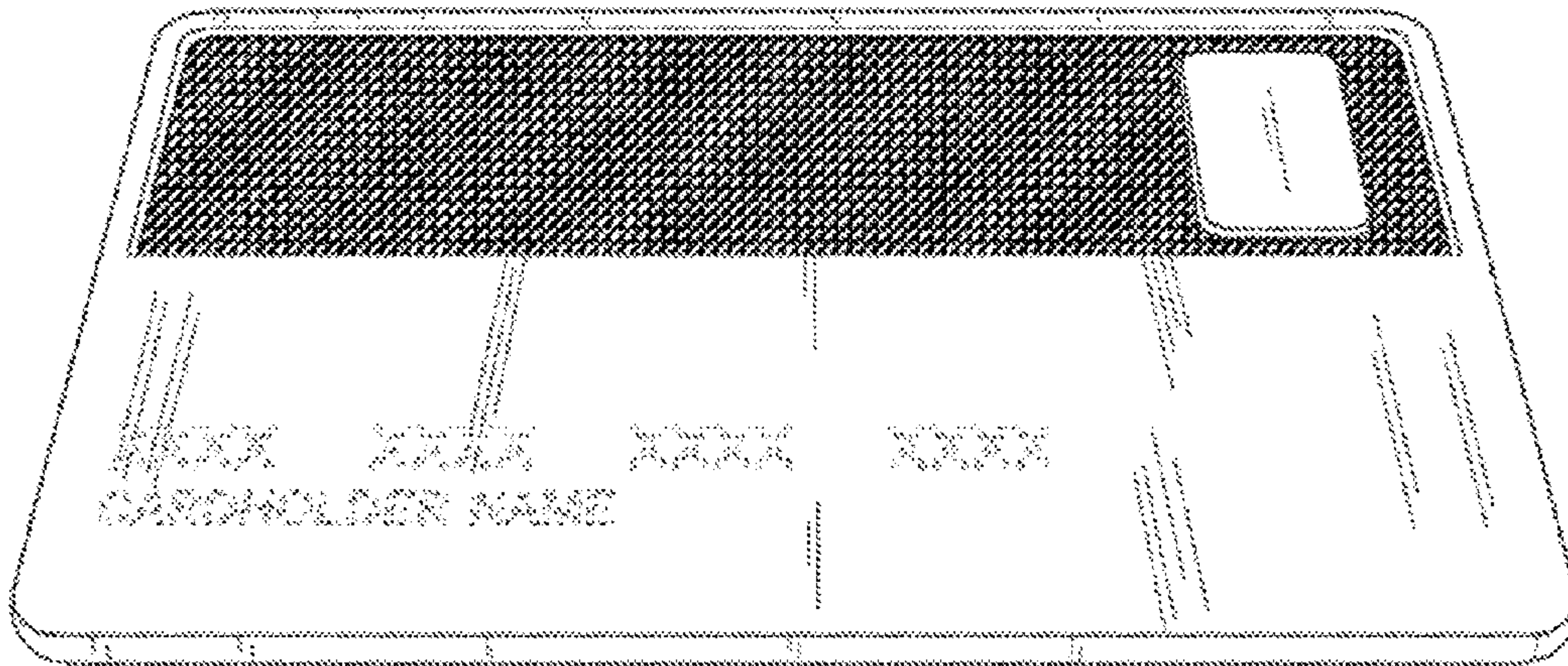

FIG. 56

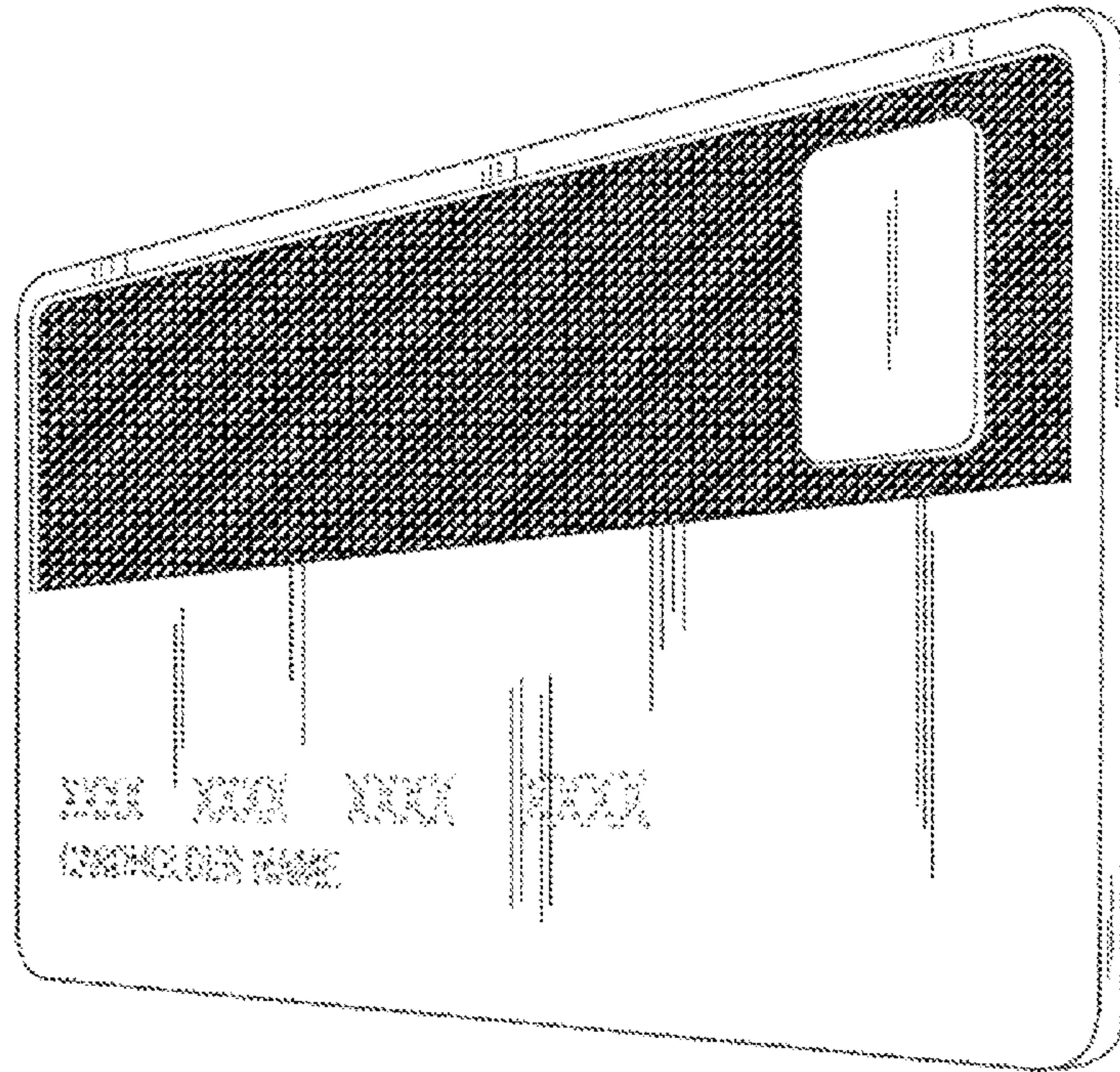

FIG. 57

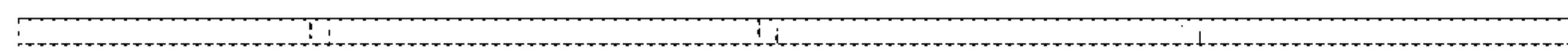

FIG. 59

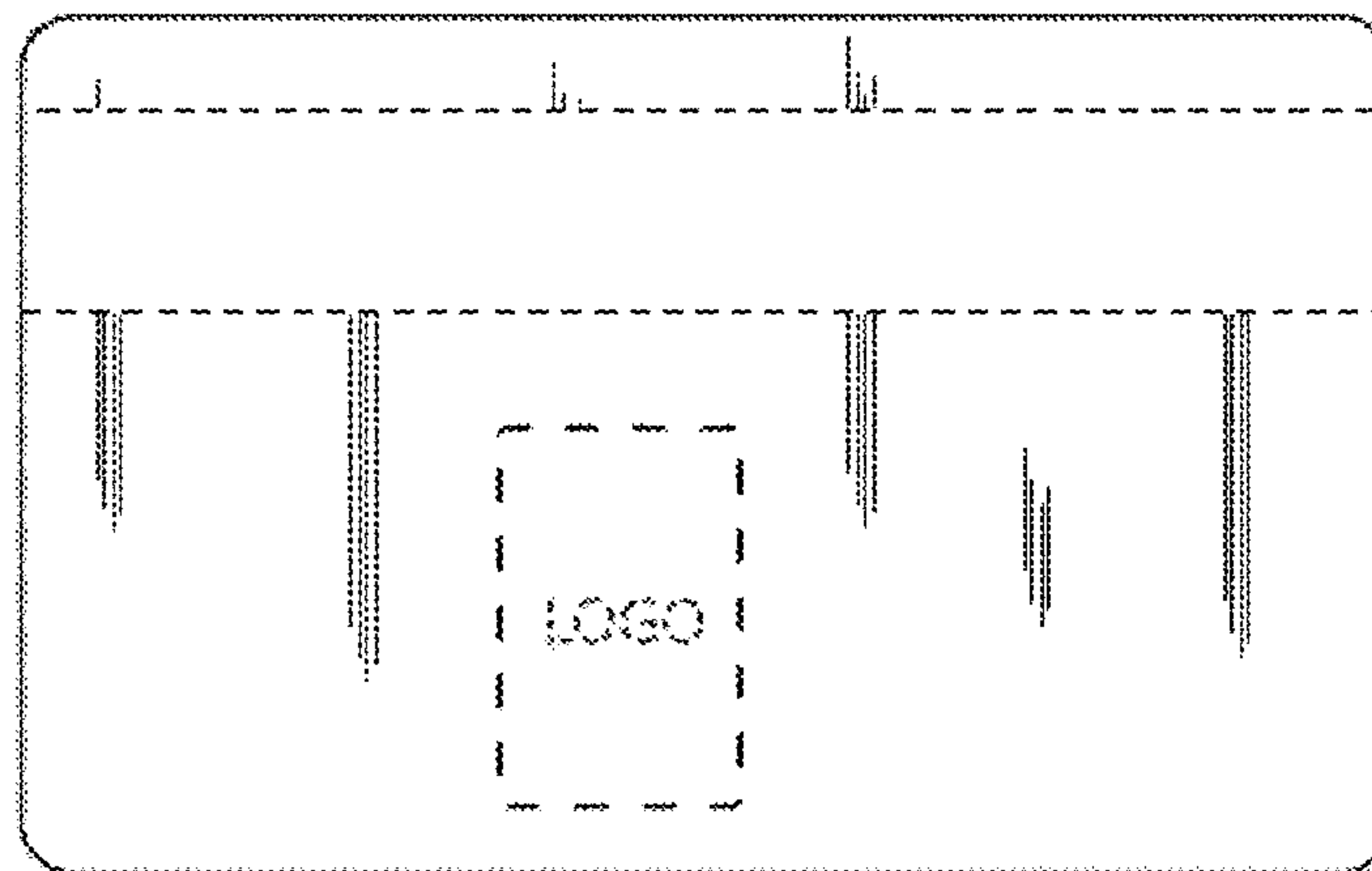

FIG. 58

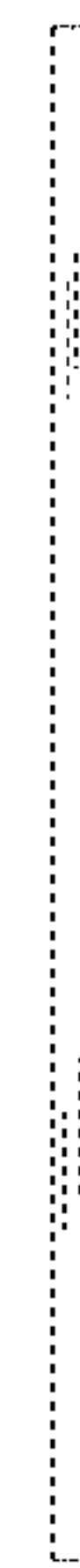

FIG. 60

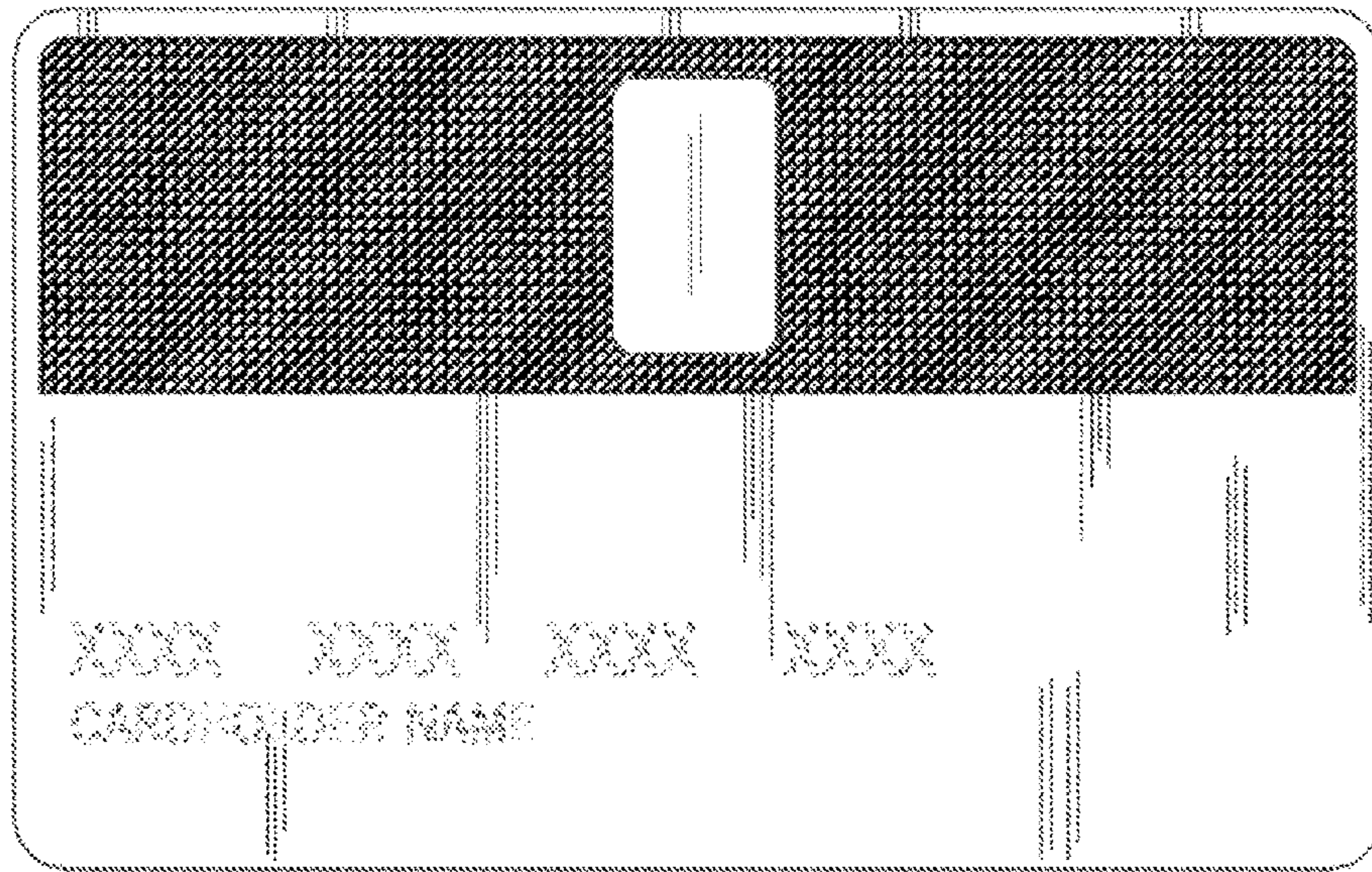

FIG. 61

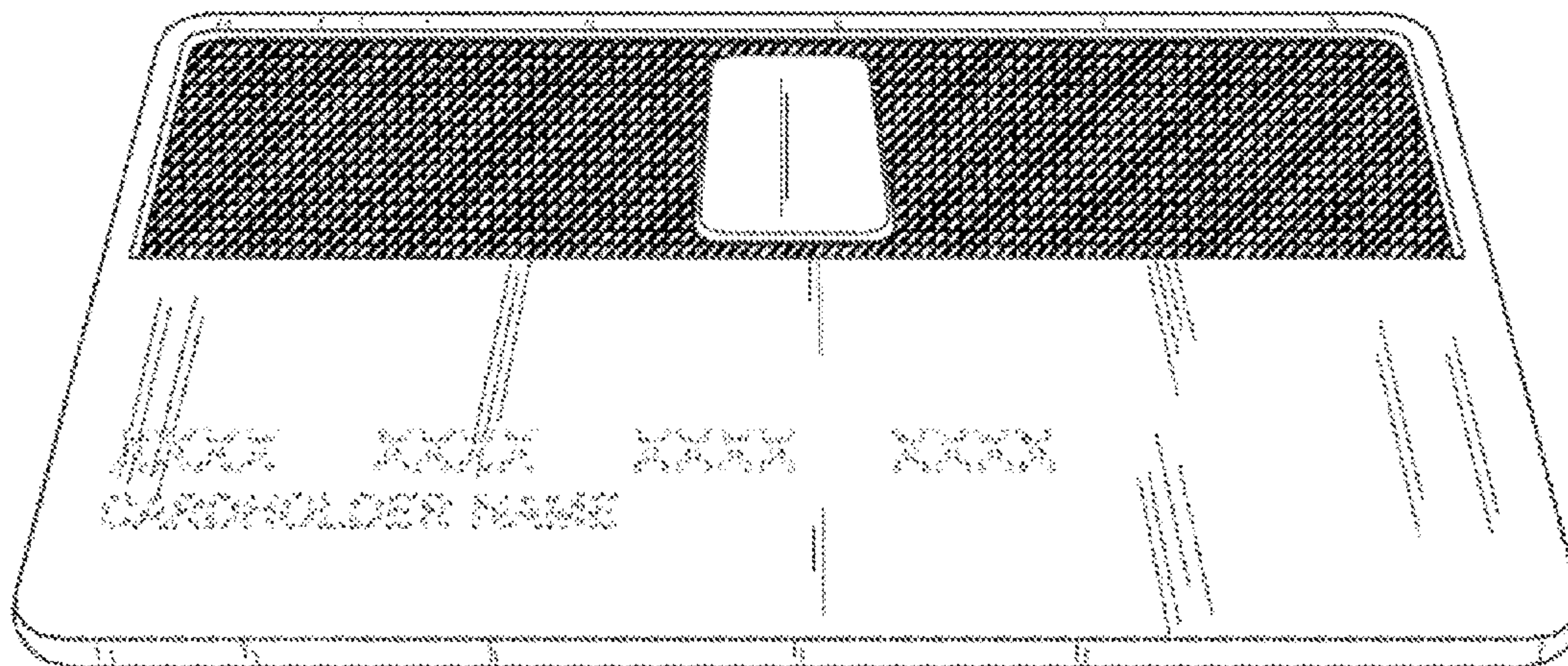

FIG. 62

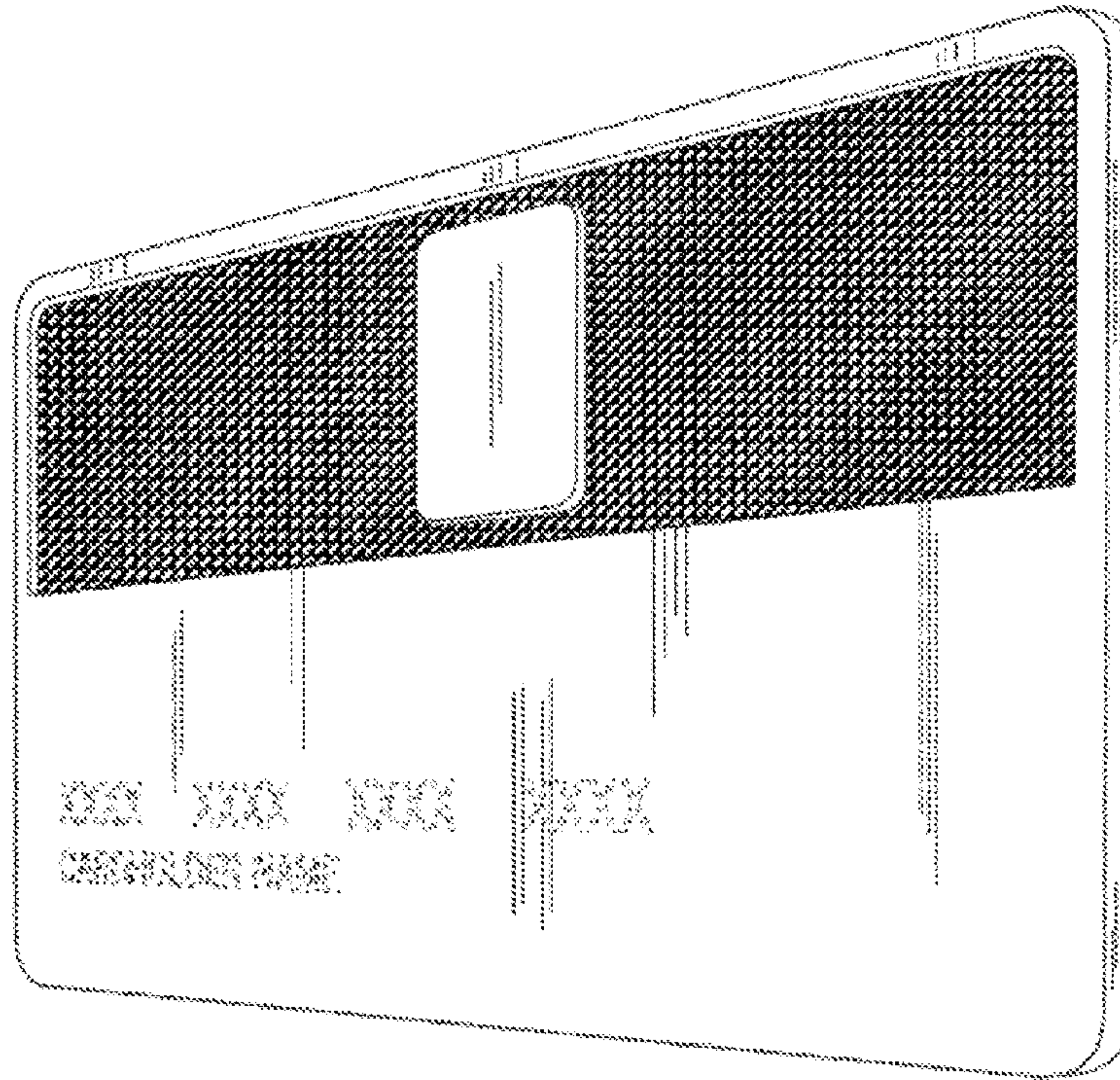

FIG. 63

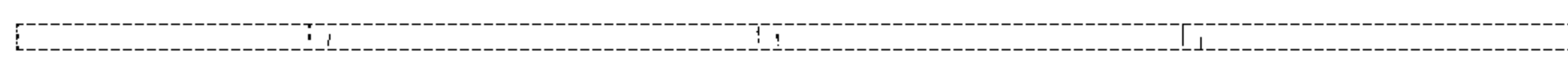

FIG. 65

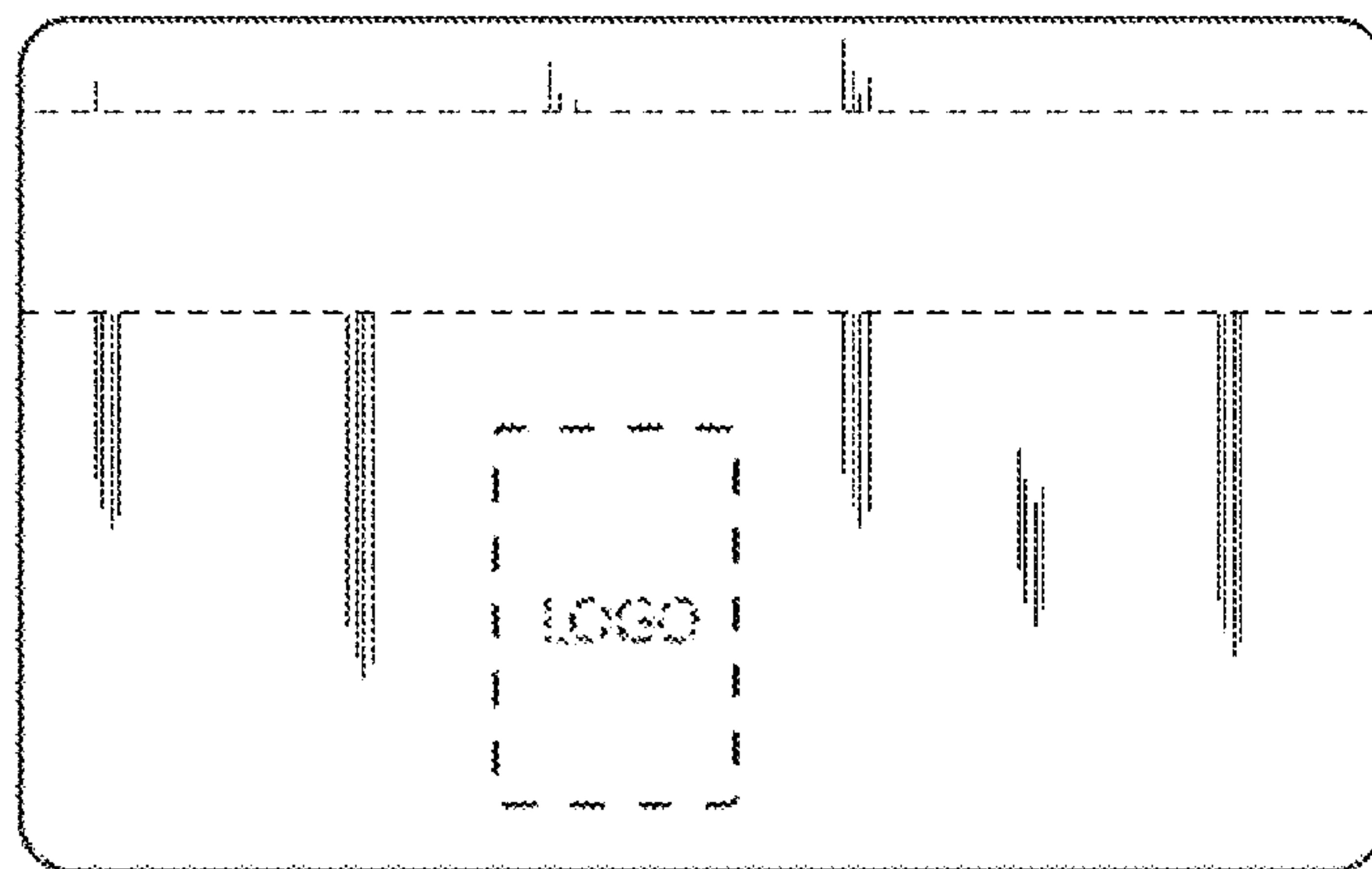

FIG. 64

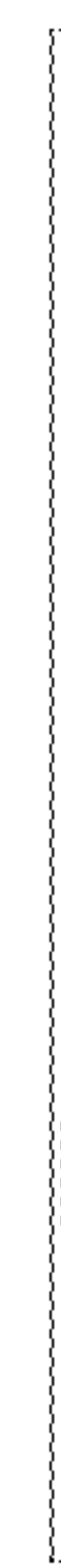

FIG. 66

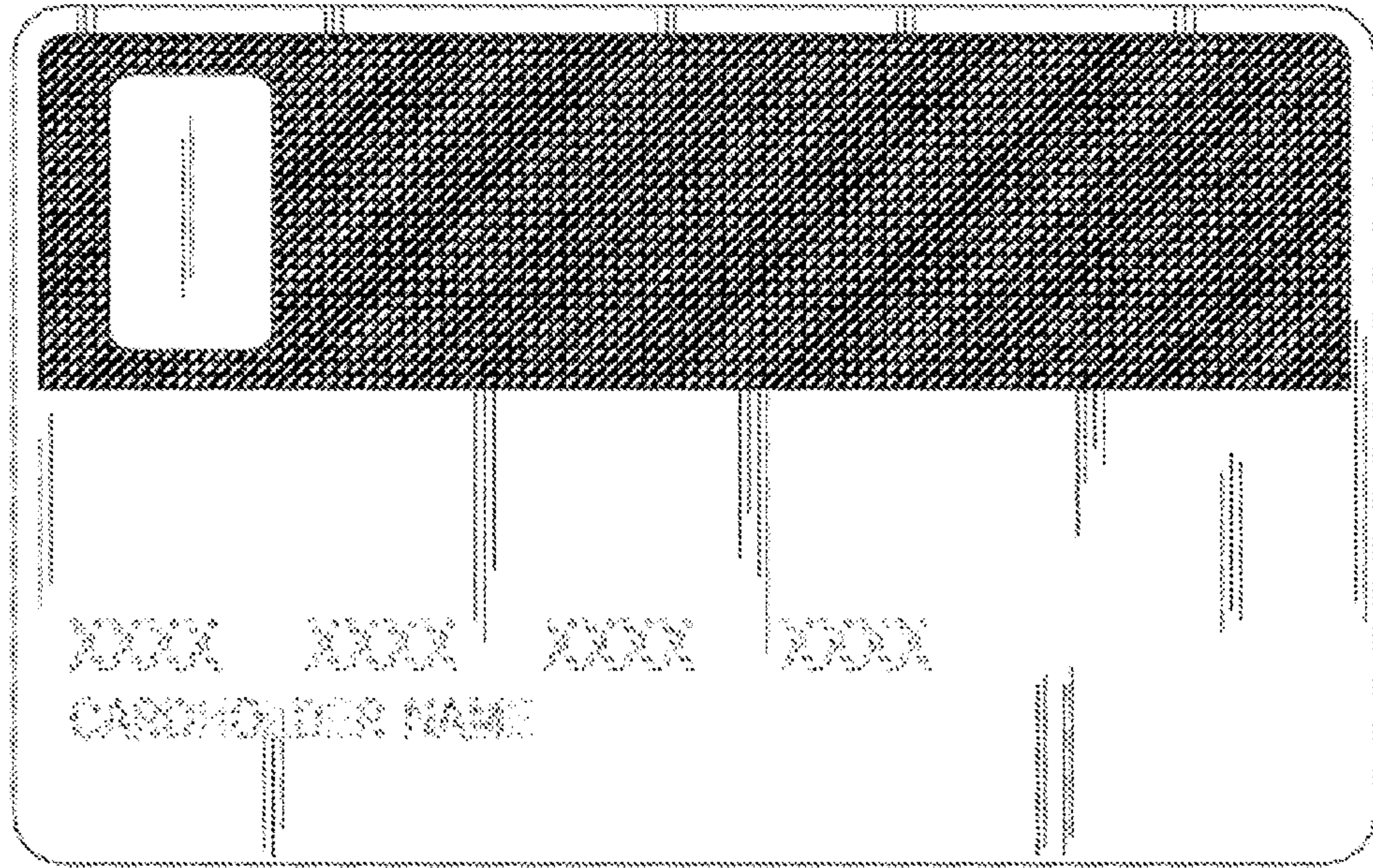

FIG. 67

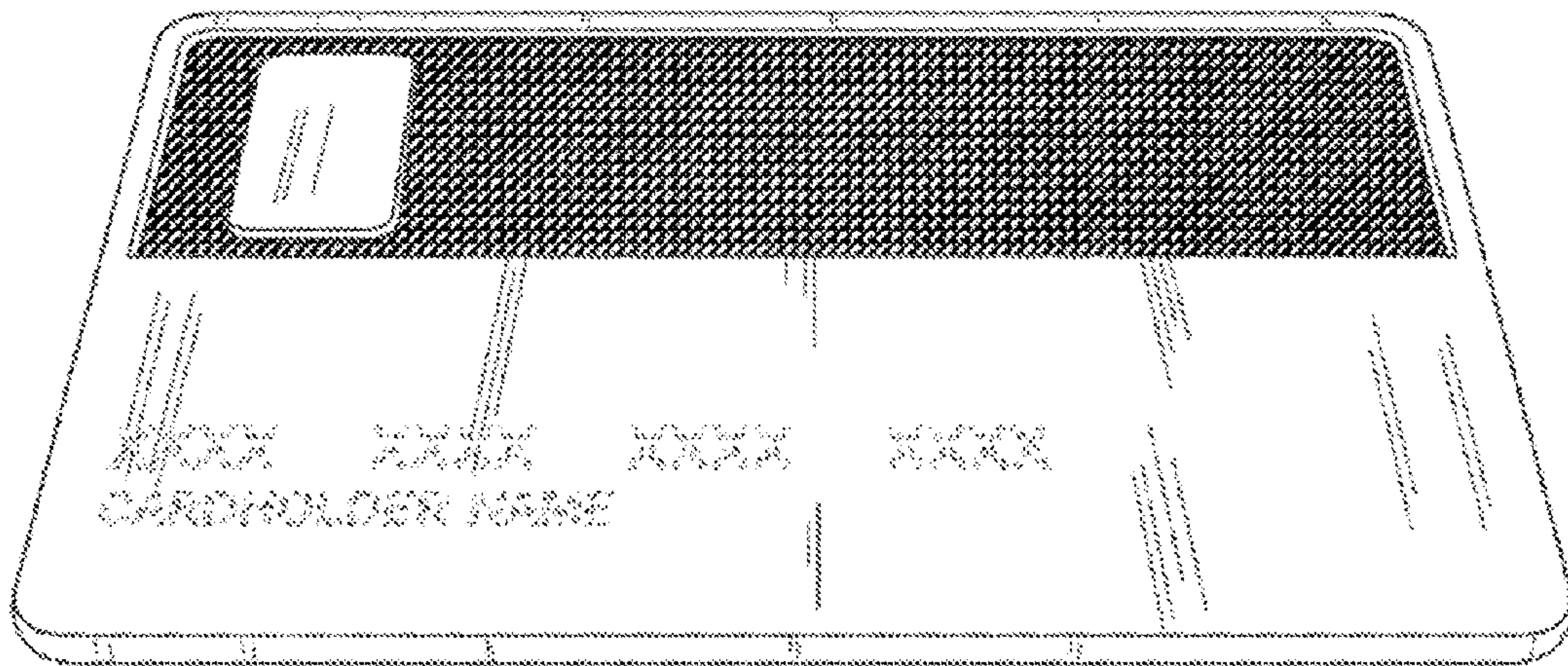

FIG. 68

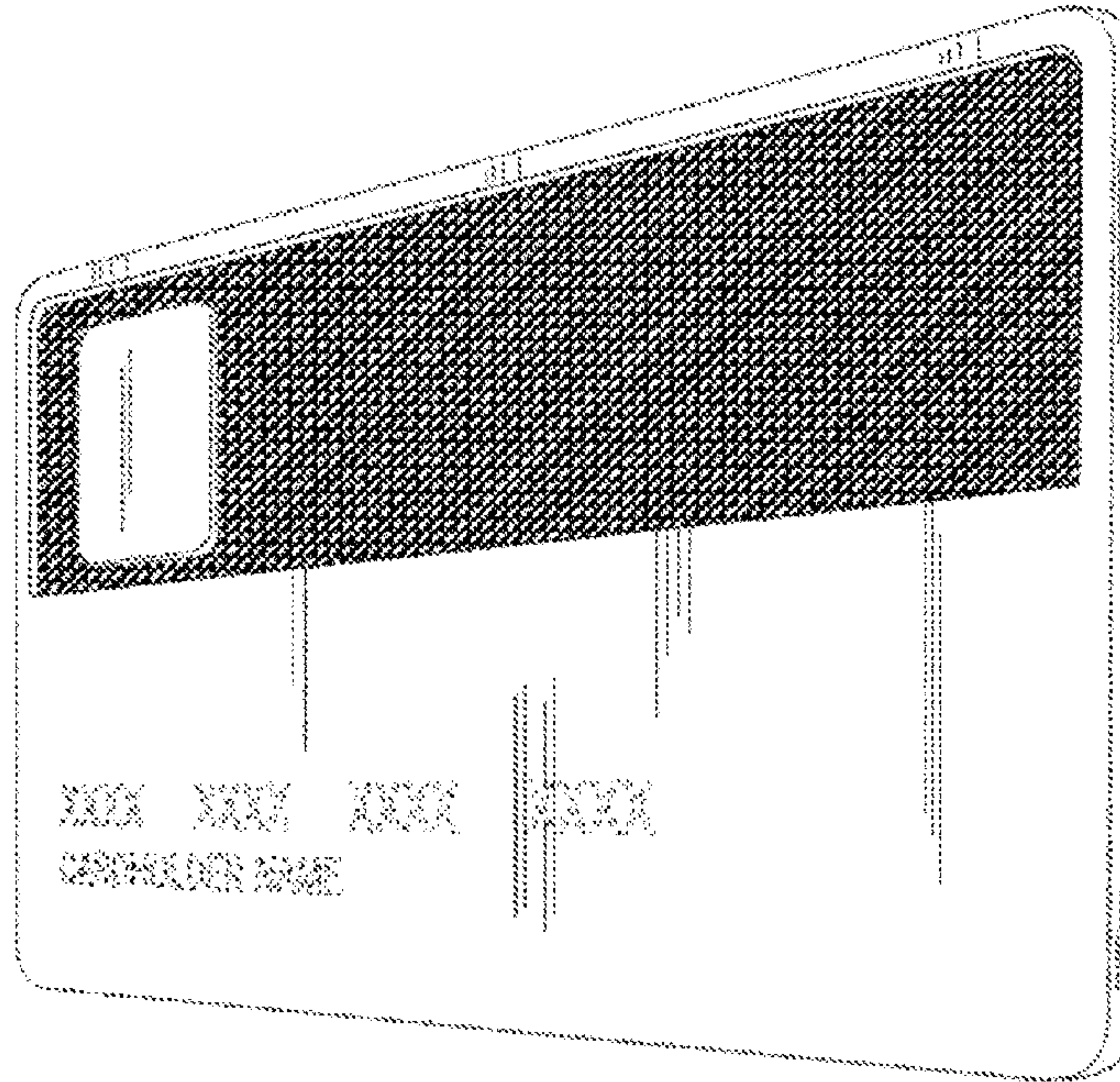

FIG. 69

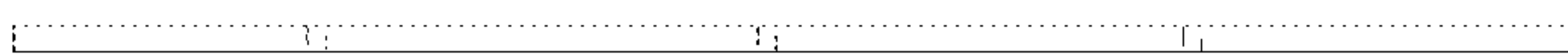

FIG. 71

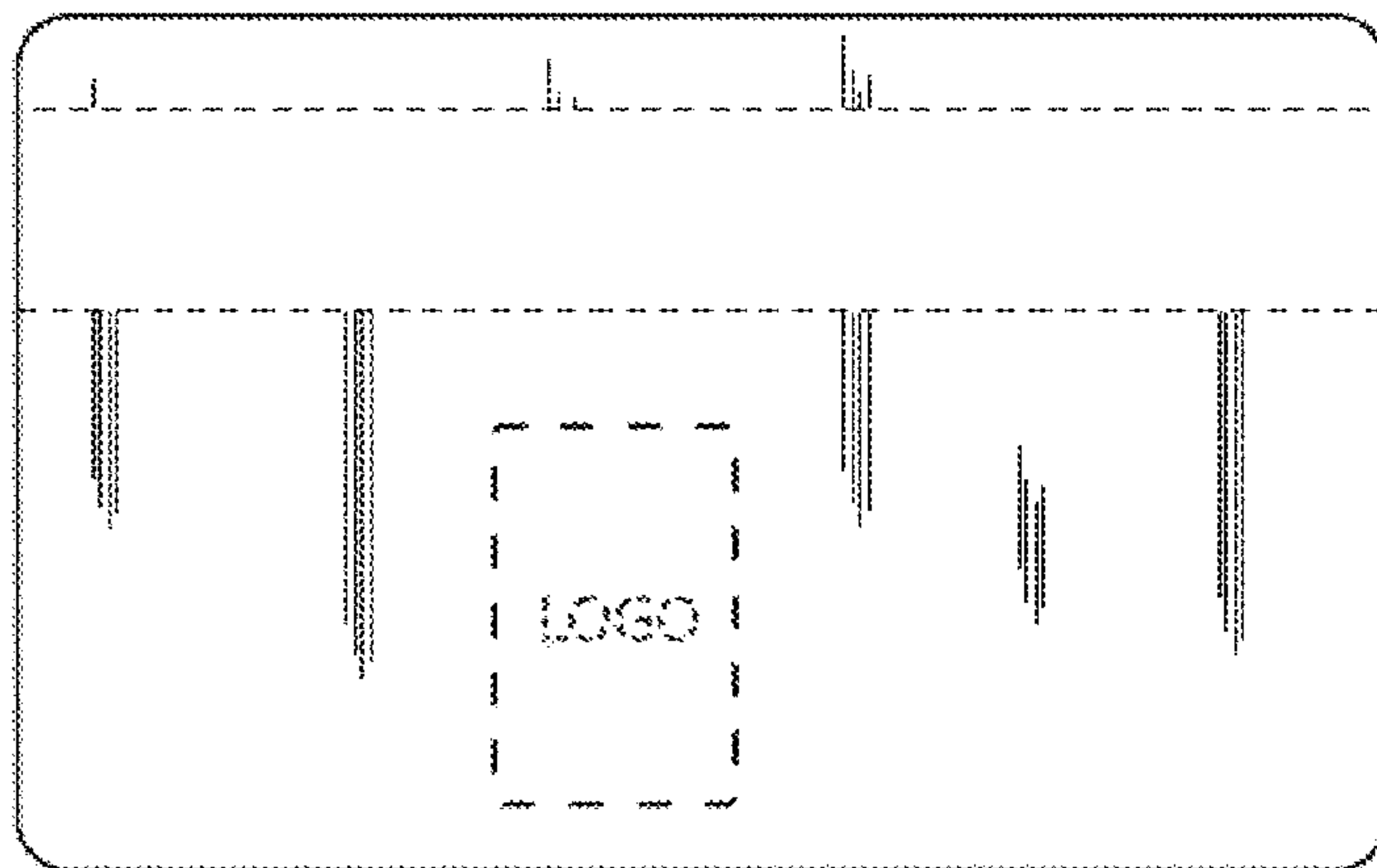

FIG. 70



FIG. 72

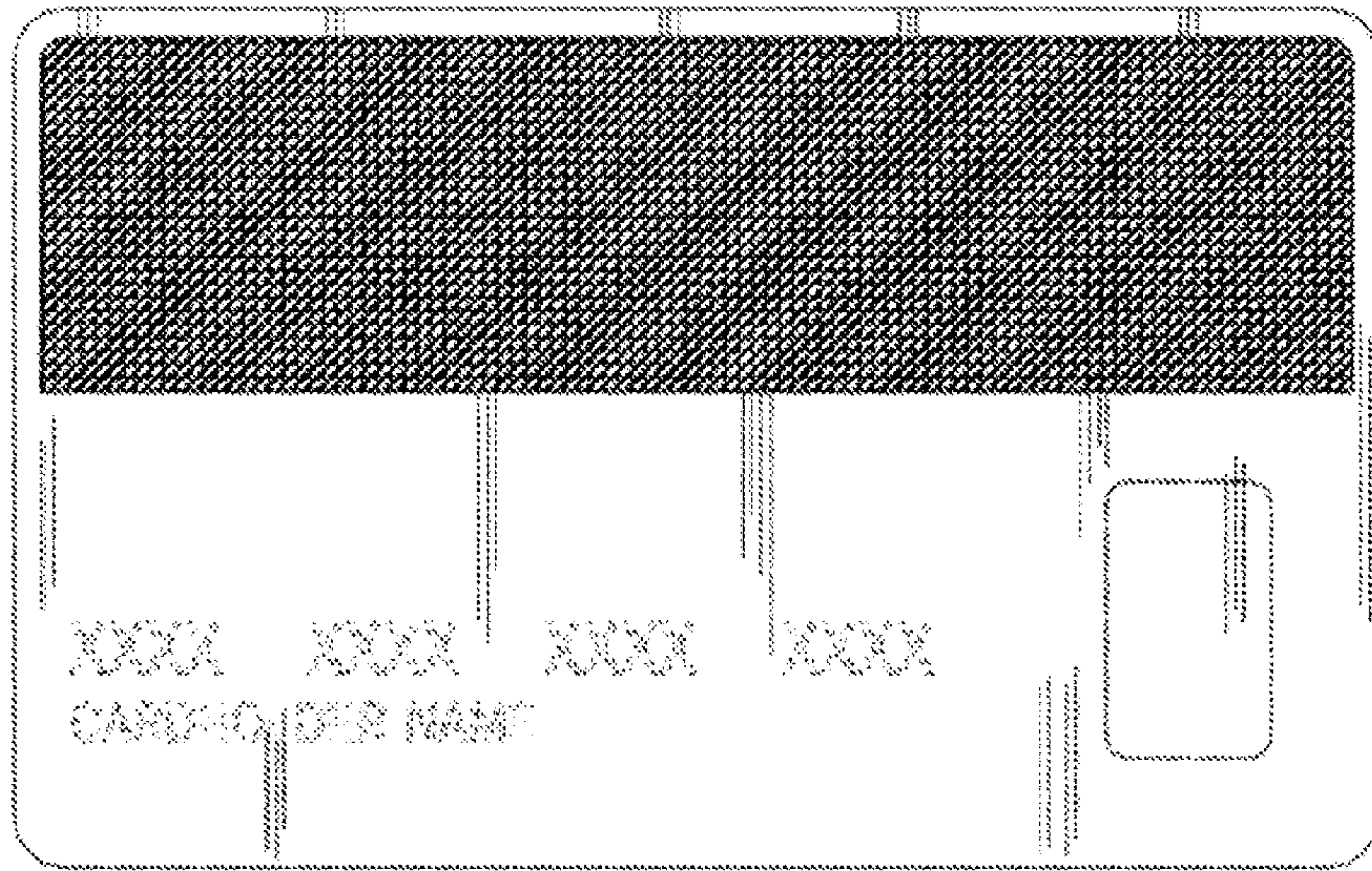

FIG. 73

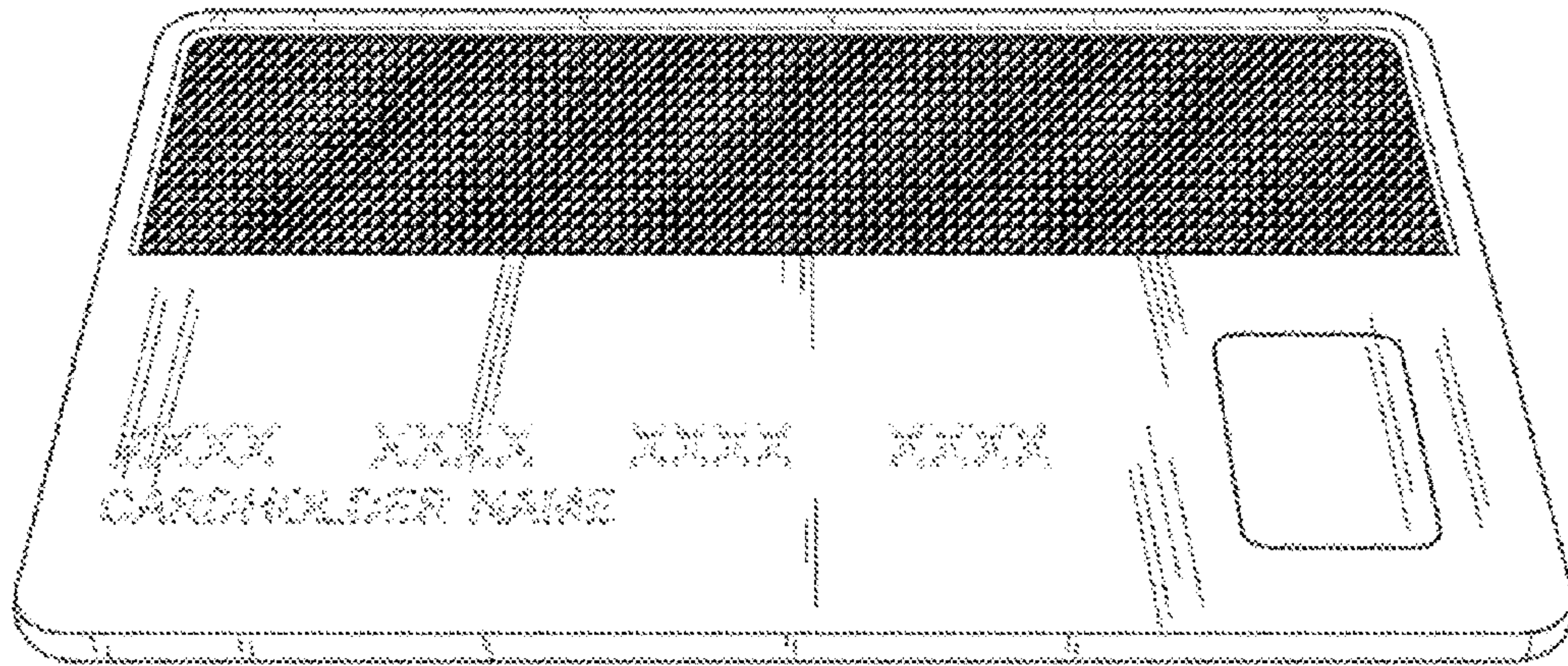

FIG. 74

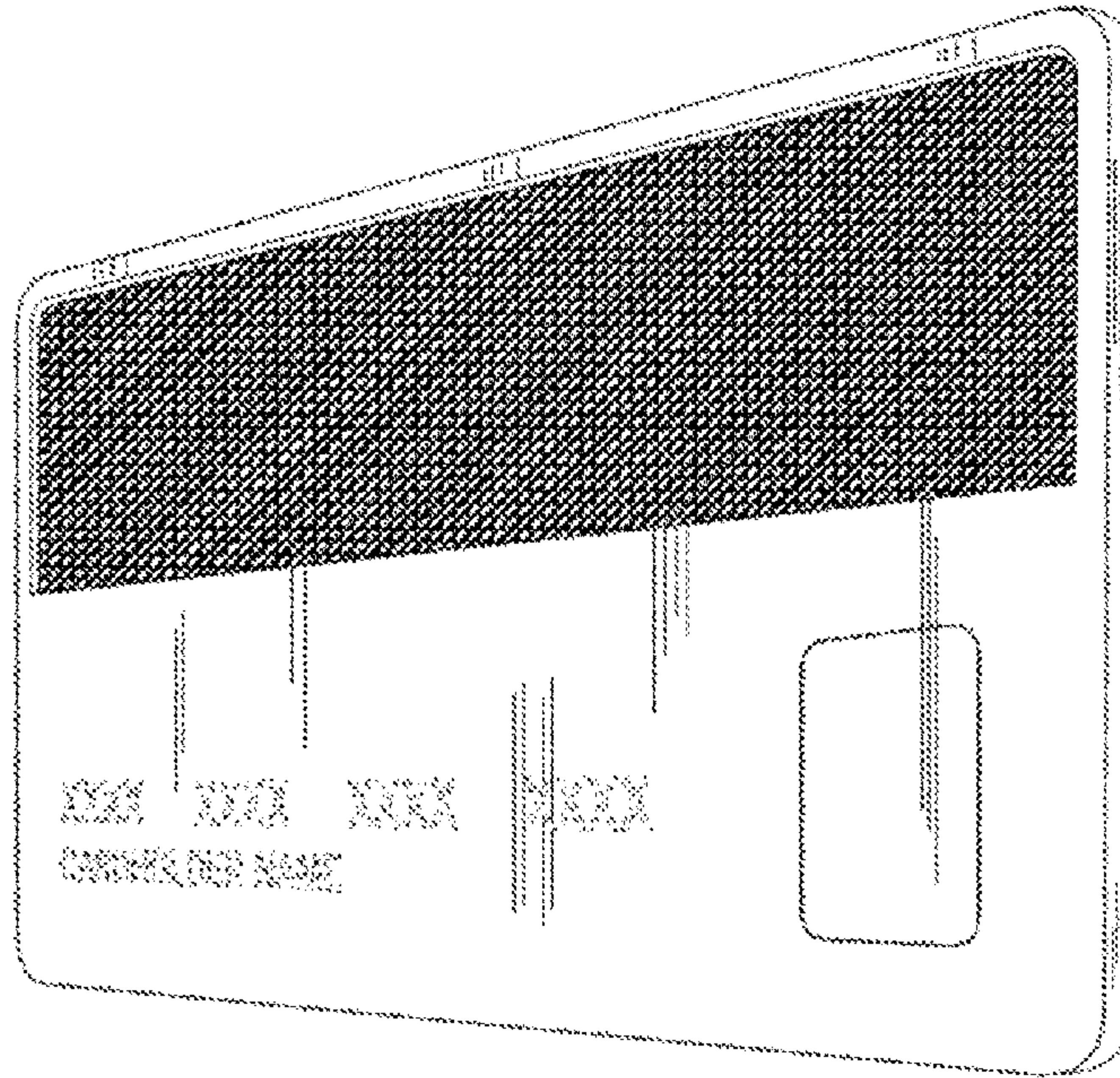

FIG. 75

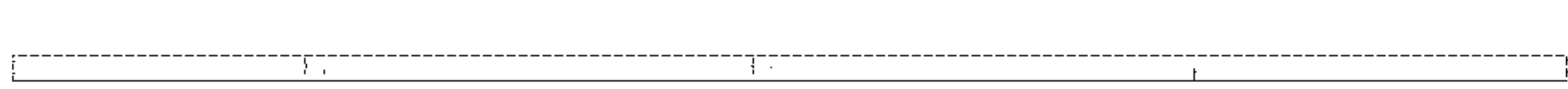

FIG. 77

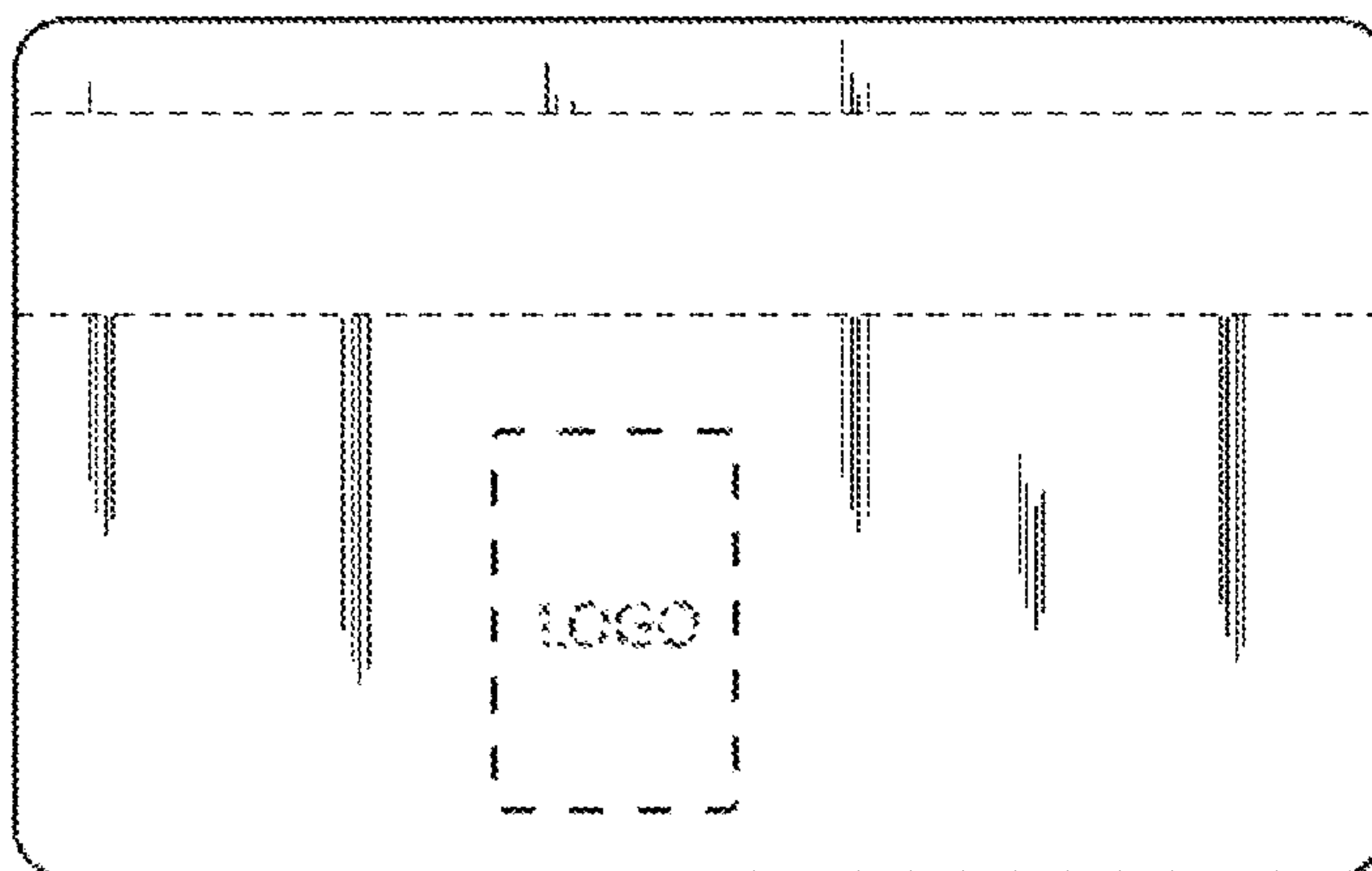

FIG. 76



FIG. 78

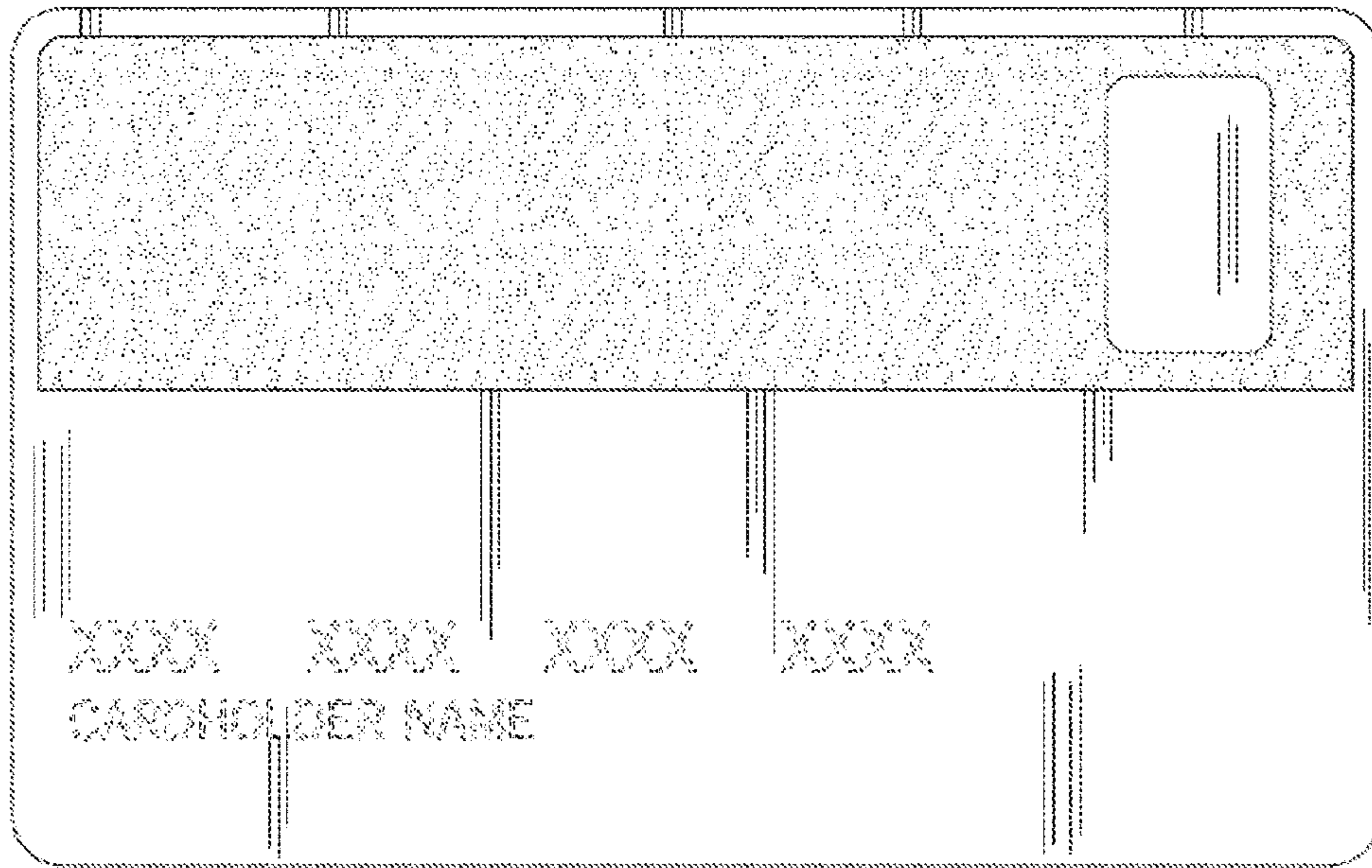

FIG. 79

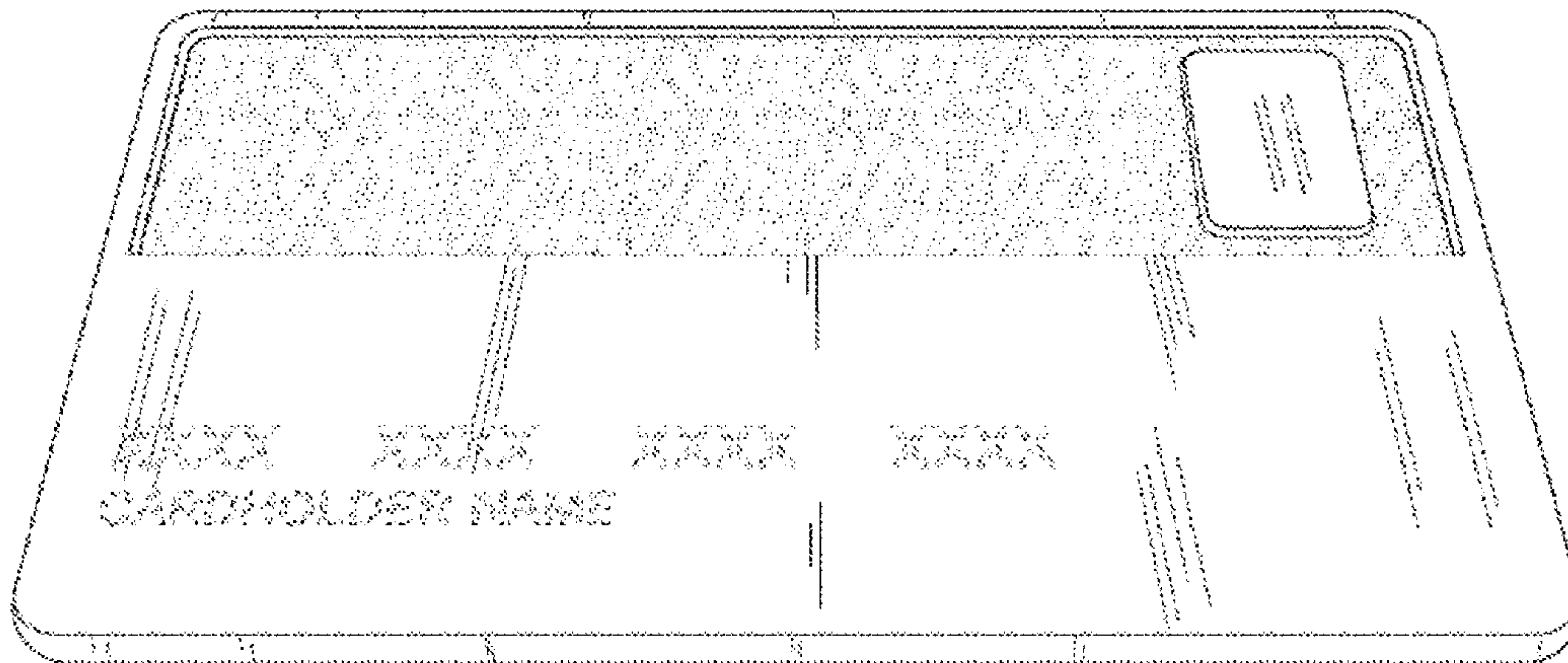

FIG. 80

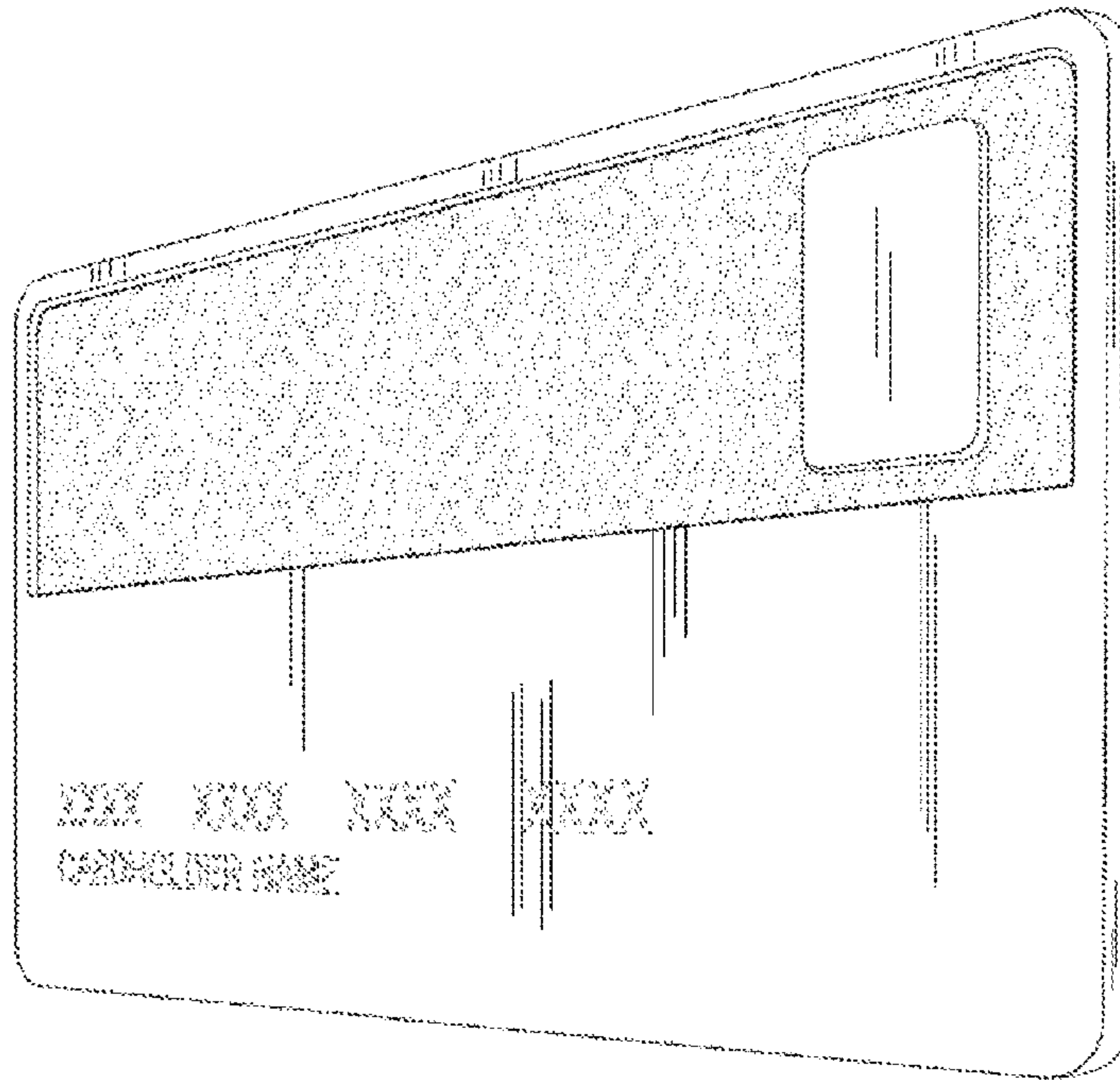

FIG. 81

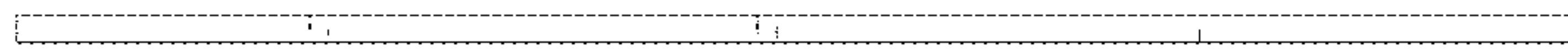

FIG. 83

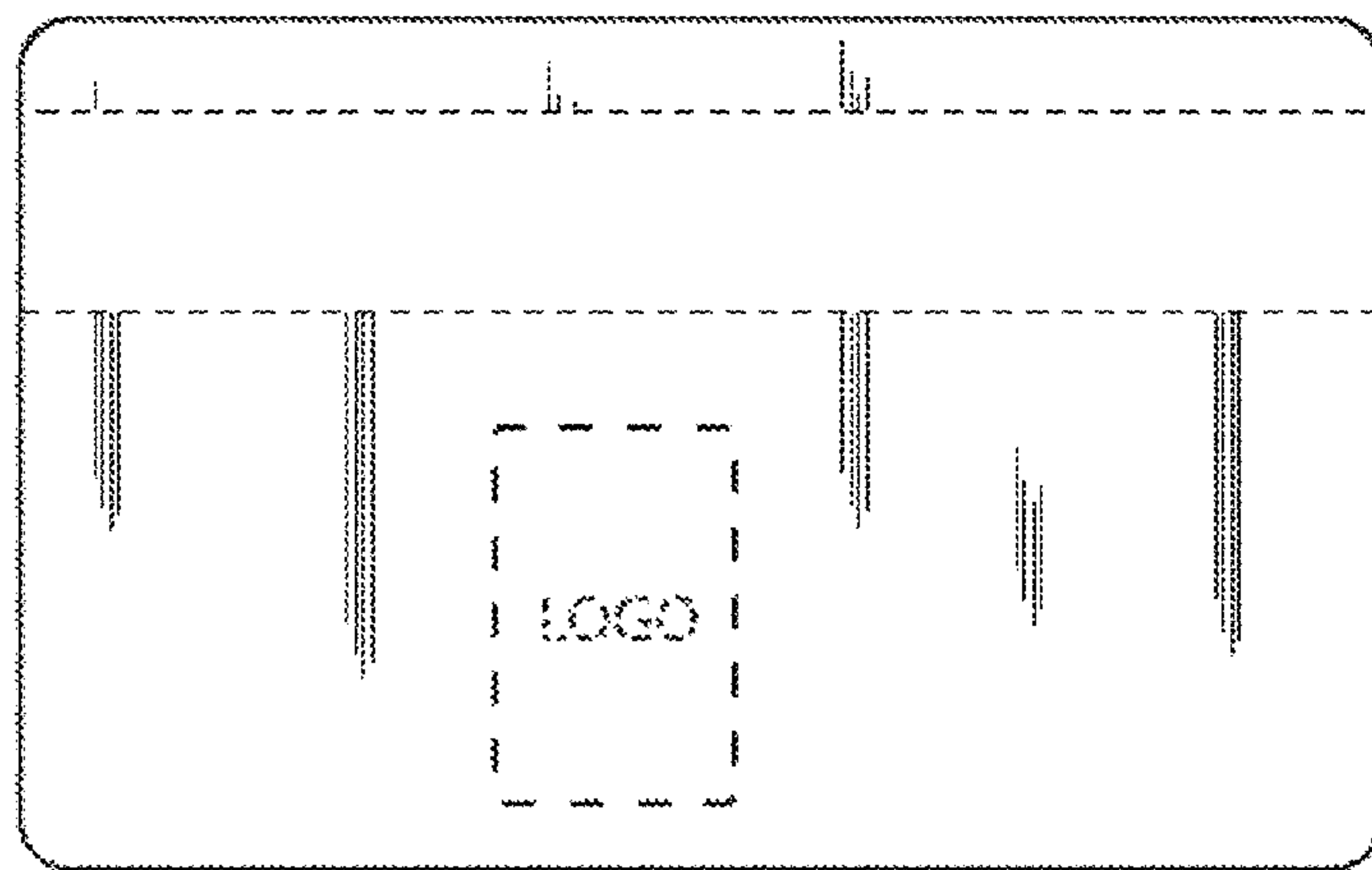

FIG. 82



FIG. 84

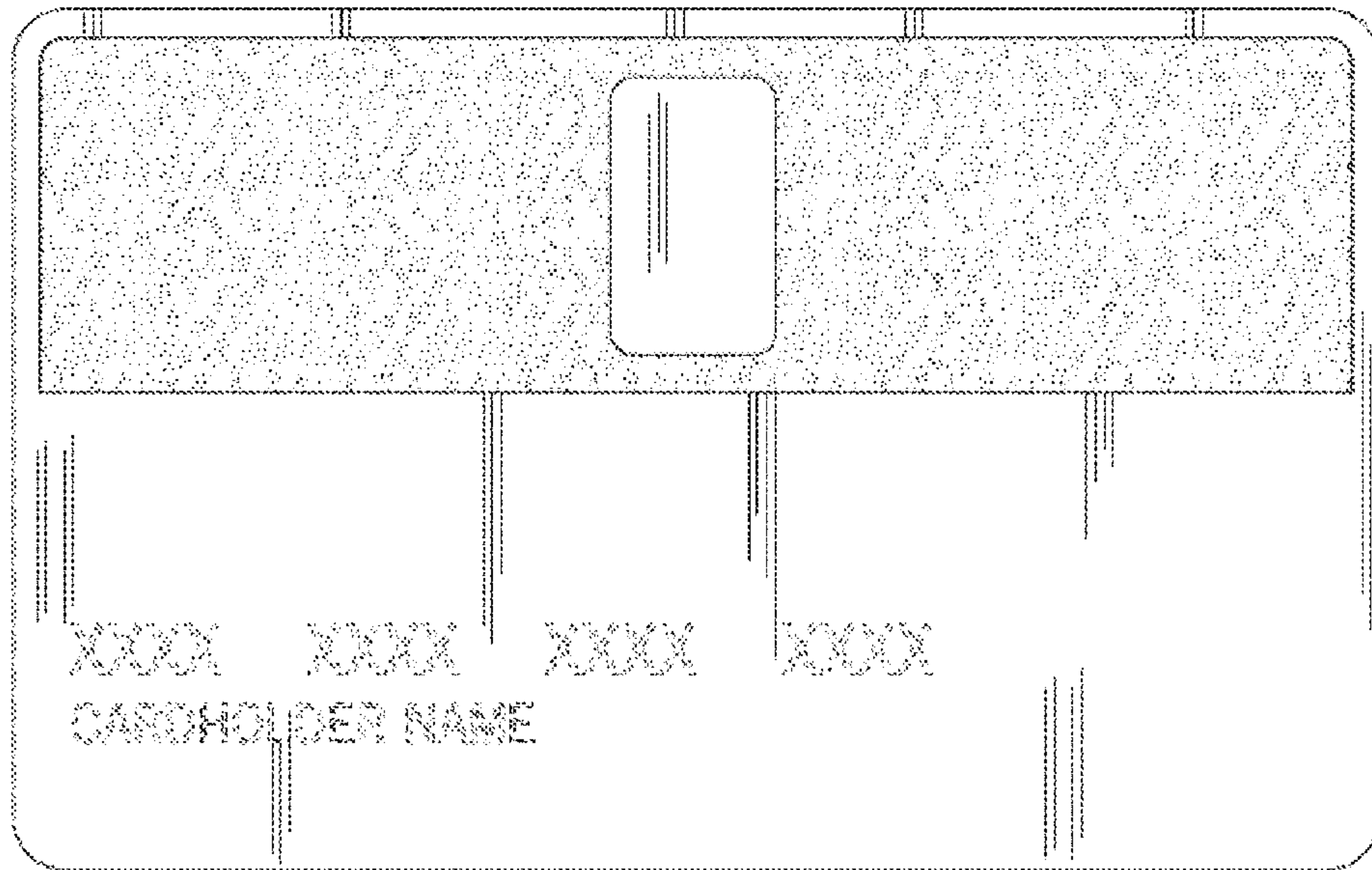

FIG. 85

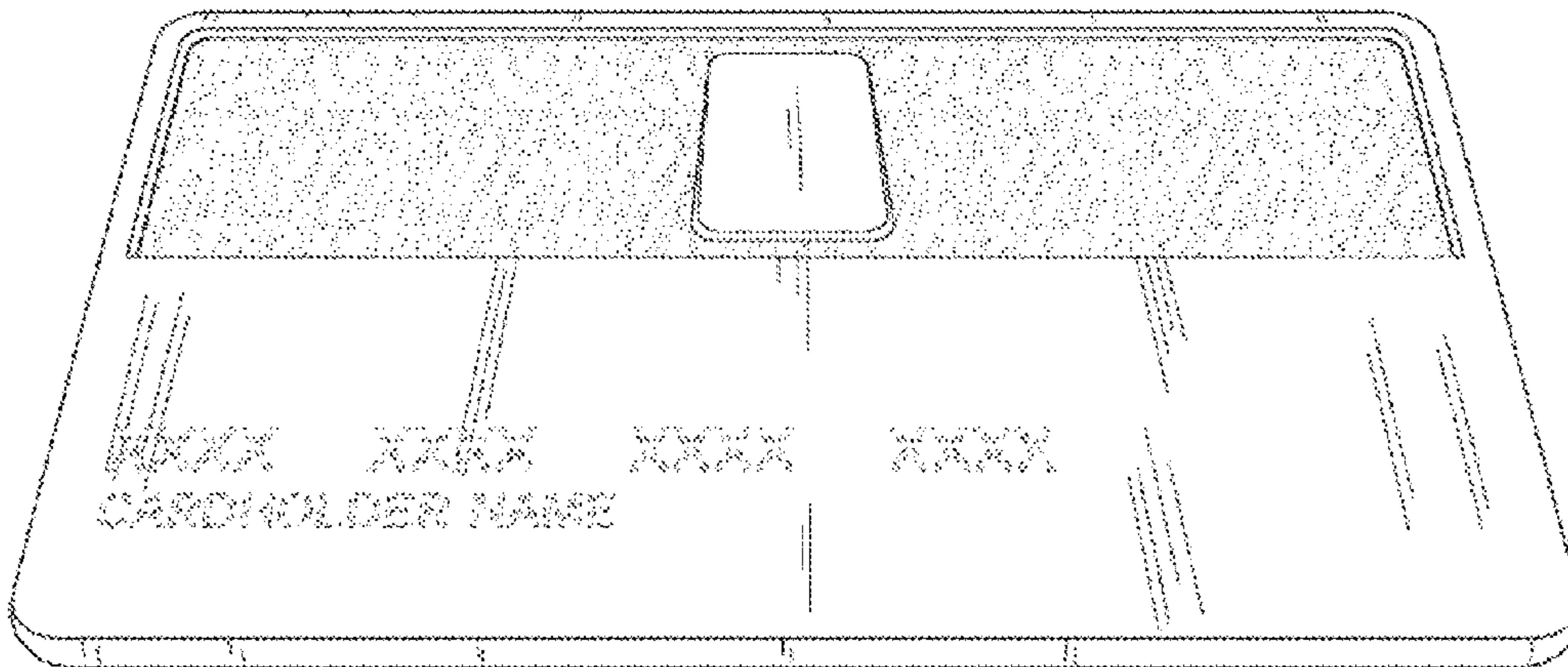

FIG. 86

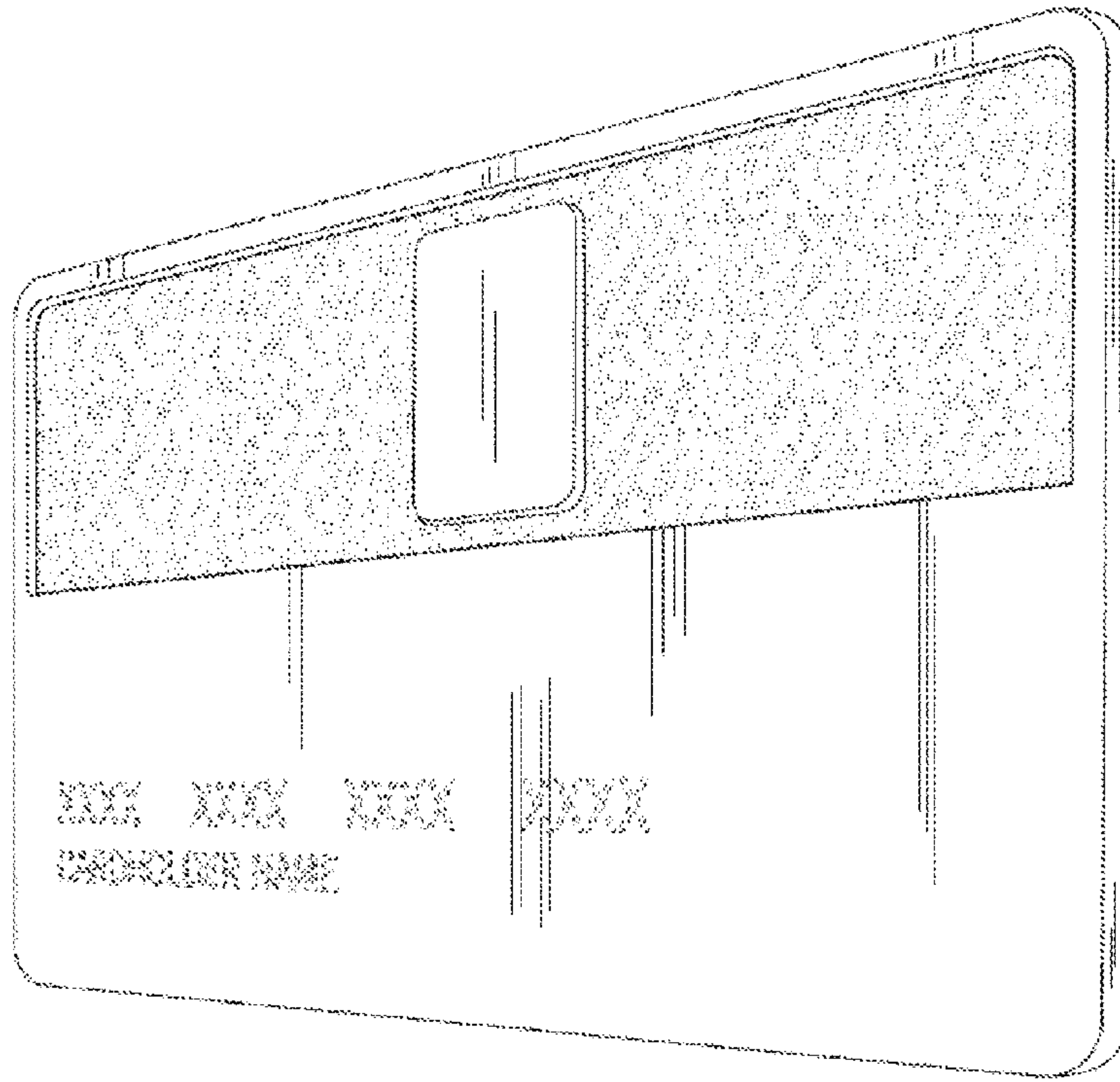

FIG. 87

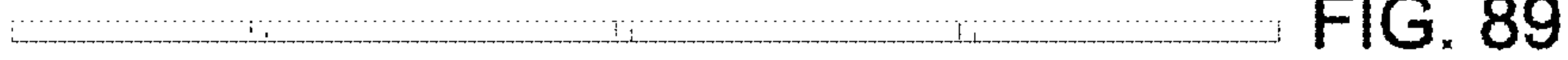

FIG. 89

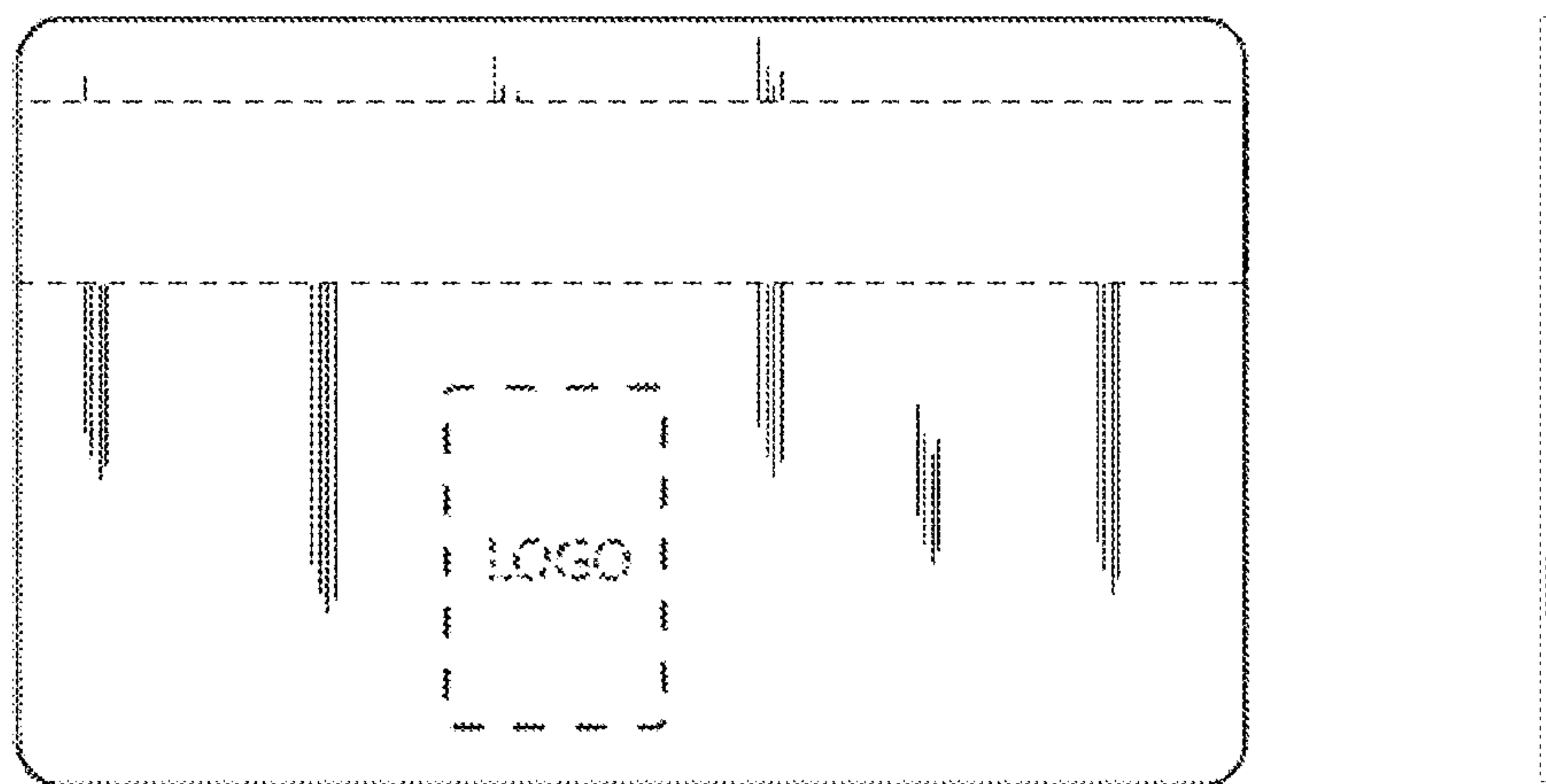

FIG. 88

FIG. 90

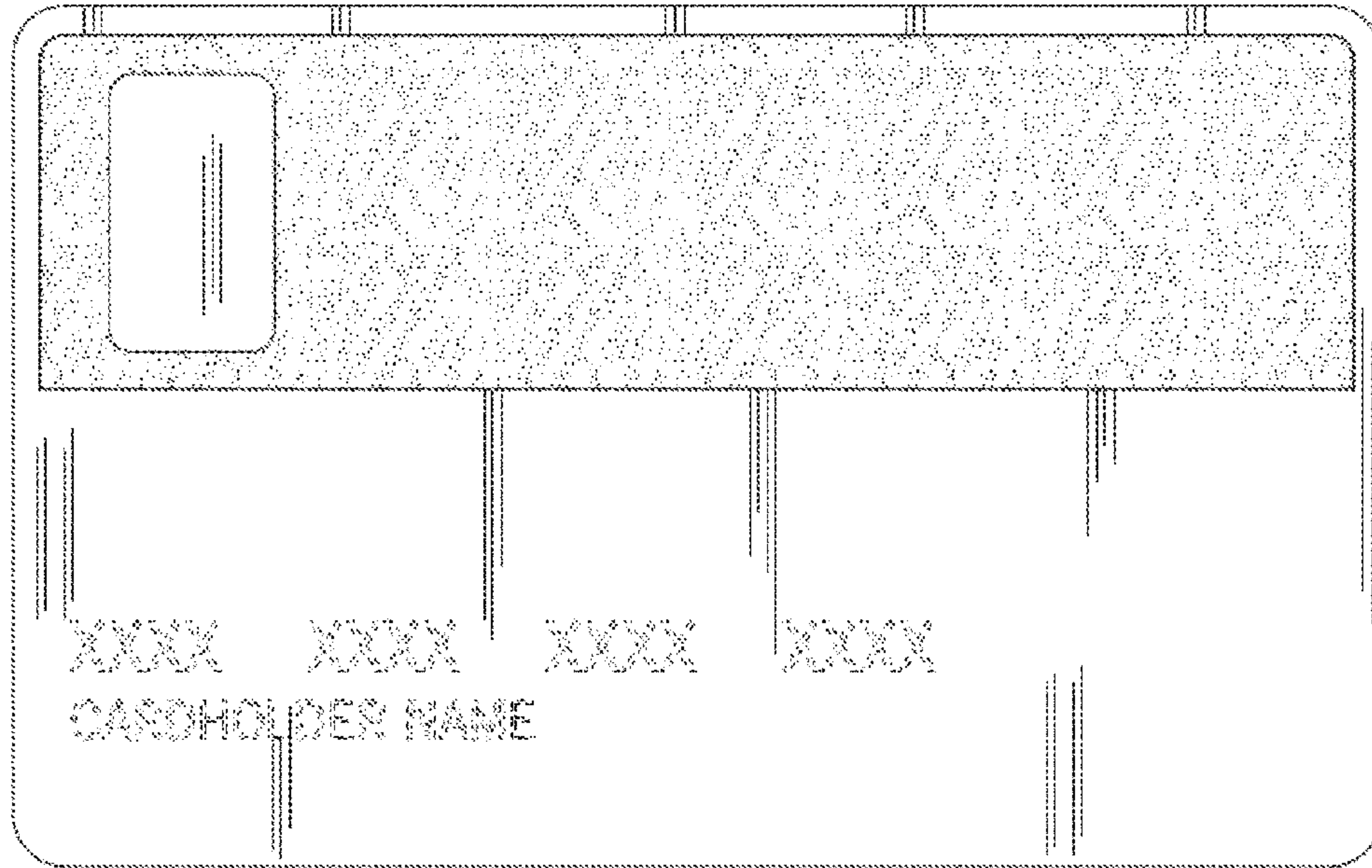

FIG. 91

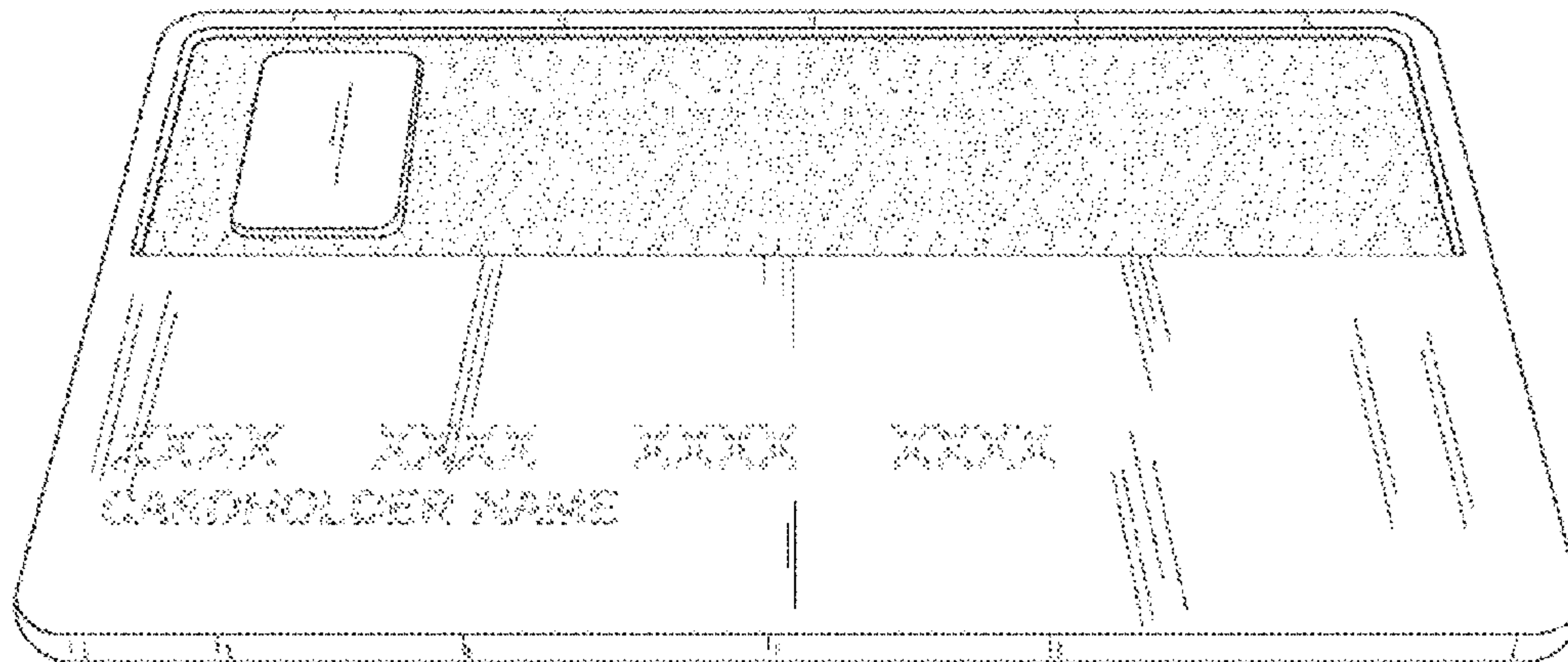

FIG. 92

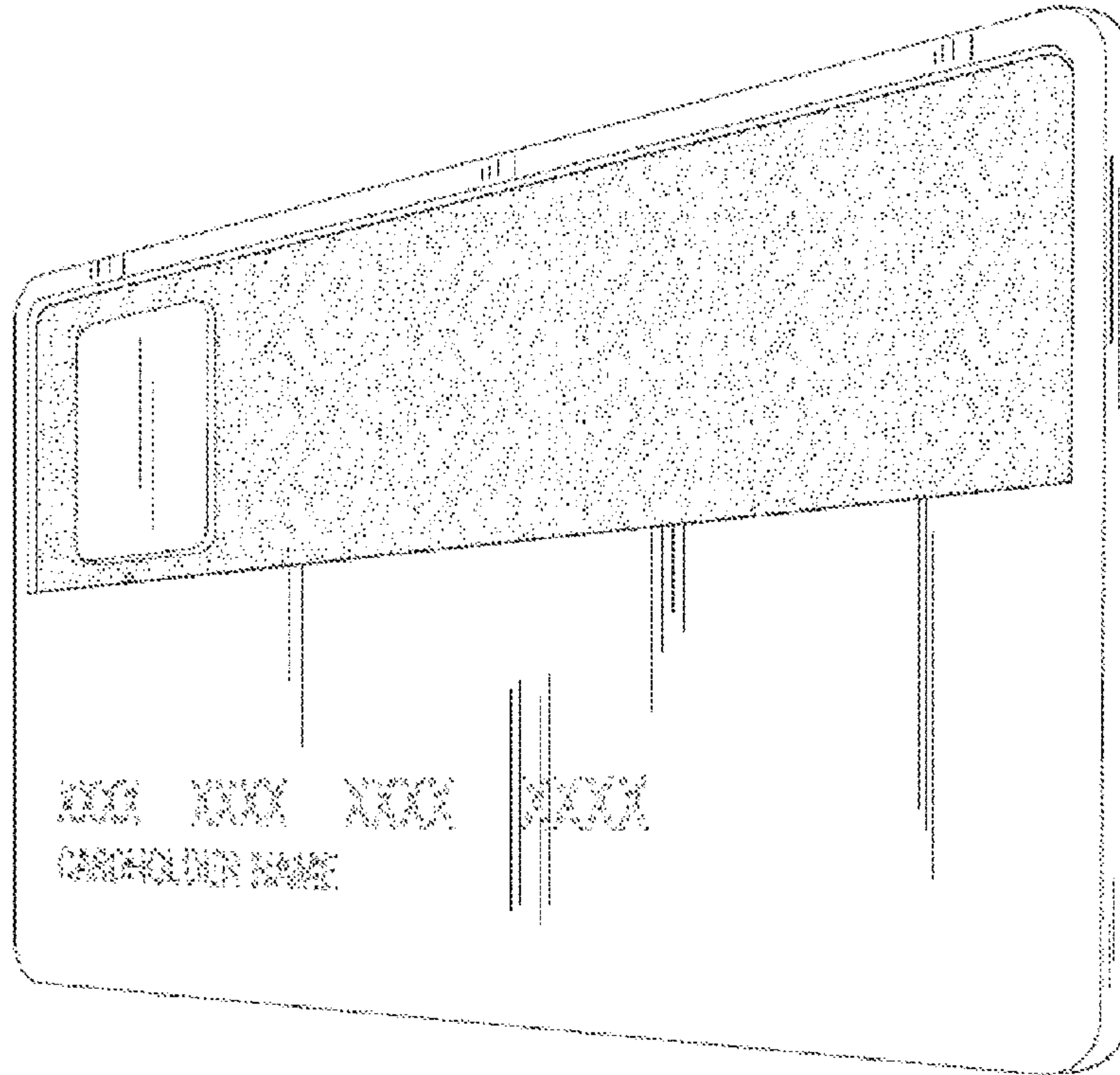

FIG. 93

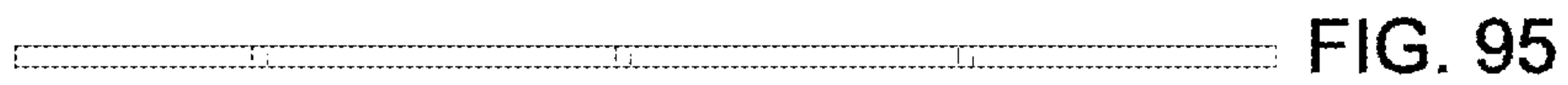

FIG. 95

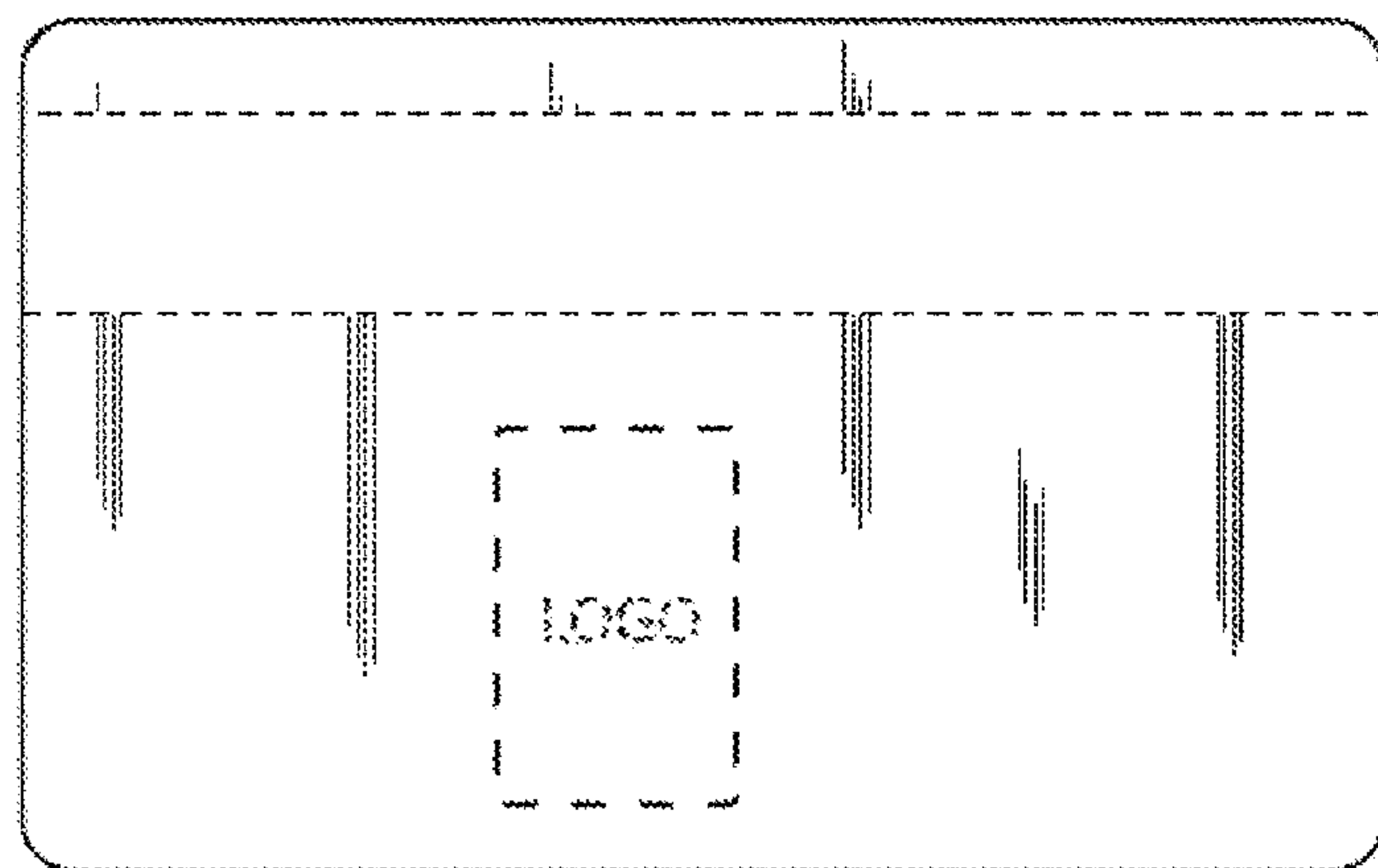

FIG. 94



FIG. 96