



US00D687827S

(12) **United States Design Patent**  
**Song et al.**

(10) **Patent No.:** **US D687,827 S**

(45) **Date of Patent:** **\*\* Aug. 13, 2013**

(54) **TABLET COMPUTER**

(75) Inventors: **Jae-Seung Song**, Seoul (KR);  
**Sang-Won Yoon**, Seoul (KR);  
**Dong-Seok Lee**, Seoul (KR)

(73) Assignee: **Samsung Electronics Co., Ltd.**,  
Suwon-Si (KR)

(\*\*) Term: **14 Years**

(21) Appl. No.: **29/408,017**

(22) Filed: **Dec. 6, 2011**

(30) **Foreign Application Priority Data**

Sep. 21, 2011 (KR) ..... 30-2011-0039083

(51) **LOC (9) Cl.** ..... **14-02**

(52) **U.S. Cl.**  
USPC ..... **D14/341**

(58) **Field of Classification Search**  
USPC ..... D14/341-347, 137, 138, 138.1, 138 AA,  
D14/138 R, 138 AB, 138 AD, 138 G, 138 A,  
D14/496, 426, 429, 129, 130, 420, 439-441,  
D14/448, 125, 147, 156, 218, 250, 389, 336,  
D14/203.1, 203.3, 203.4, 203.7, 315; D21/324,  
D21/329, 330; D10/65, 104; D18/6-7;  
345/169, 901, 905, 156, 157, 168, 173;  
361/814, 680, 686, 679.27, 679.3; 341/22;  
348/168; 379/433.04, 433.07, 433.11, 916,  
379/433.01, 433.06

See application file for complete search history.

(56) **References Cited**

**U.S. PATENT DOCUMENTS**

D284,084 S 6/1986 Ferrara, Jr.  
D306,583 S 3/1990 Krolopp et al.  
D333,574 S 3/1993 Ackeret  
D337,569 S 7/1993 Kando  
D500,991 S 1/2005 Niitsu

D504,889 S \* 5/2005 Andre et al. .... D14/341  
D532,791 S 11/2006 Kim  
D563,804 S 3/2008 Kimura et al.  
D579,930 S \* 11/2008 Maskatia ..... D14/341  
D584,738 S 1/2009 Kim et al.  
D590,374 S 4/2009 Madonna et al.  
D592,214 S 5/2009 Bradford  
D602,014 S 10/2009 Andre et al.  
D602,487 S \* 10/2009 Maskatia ..... D14/341  
D605,626 S 12/2009 Park

(Continued)

**FOREIGN PATENT DOCUMENTS**

KR 3005985190000 5/2011  
KR 3005994750000 5/2011

(Continued)

**OTHER PUBLICATIONS**

U.S. Appl. No. 29/390,463, Applicant: Kim, et al., filed Apr. 25, 2011  
entitled Tablet Computer.

(Continued)

*Primary Examiner* — Barbara Fox  
(74) *Attorney, Agent, or Firm* — Wood, Herron & Evans,  
LLP

(57) **CLAIM**  
The ornamental design for tablet computer, as shown and  
described.

**DESCRIPTION**

FIG. 1 is a top front perspective view of tablet computer  
showing our new design;  
FIG. 2 is a front elevational view thereof;  
FIG. 3 is a rear elevational view thereof;  
FIG. 4 is a left side elevational view thereof;  
FIG. 5 is a right side elevational view thereof;  
FIG. 6 is a top plan view thereof; and,  
FIG. 7 is a bottom plan view thereof.

**1 Claim, 3 Drawing Sheets**

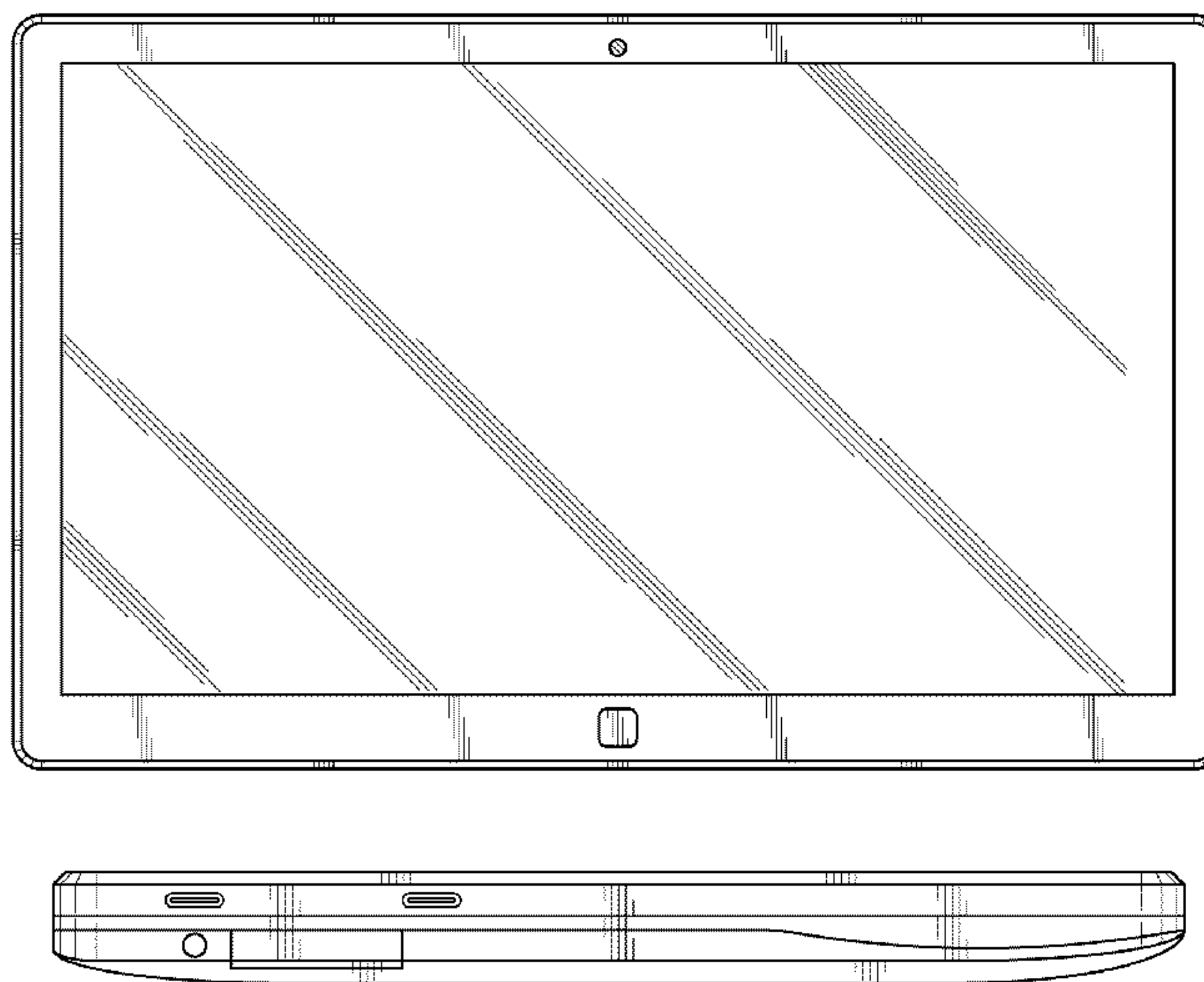

(56)

References Cited

U.S. PATENT DOCUMENTS

D610,582 S 2/2010 Sugitani et al.  
 D611,364 S 3/2010 Lenz et al.  
 D613,510 S 4/2010 Tzeng et al.  
 D613,951 S 4/2010 Tang et al.  
 D617,793 S 6/2010 Chiang et al.  
 D622,270 S 8/2010 Andre et al.  
 D624,914 S \* 10/2010 Wang ..... D14/371  
 D627,667 S 11/2010 Lenz et al.  
 D628,913 S 12/2010 Cheng  
 D629,799 S 12/2010 Andre et al.  
 D634,318 S \* 3/2011 Buckle et al. .... D14/341  
 D636,391 S \* 4/2011 Shen et al. .... D14/341  
 D636,769 S \* 4/2011 Wood et al. .... D14/341  
 D636,770 S \* 4/2011 Li ..... D14/341  
 D639,266 S \* 6/2011 DeLorenzo et al. .... D14/142  
 D640,255 S 6/2011 Lee et al.  
 D641,018 S \* 7/2011 Lee et al. .... D14/341  
 D646,902 S \* 10/2011 Woo et al. .... D6/308  
 D663,298 S \* 7/2012 Song et al. .... D14/341  
 D664,954 S \* 8/2012 Kim et al. .... D14/341  
 D666,198 S \* 8/2012 Van Den Nieuwenhuizen  
 et al. .... D14/341  
 D667,396 S \* 9/2012 Koh ..... D14/341  
 D667,397 S \* 9/2012 Koh ..... D14/341  
 D667,398 S \* 9/2012 Koh ..... D14/341  
 D667,399 S \* 9/2012 Koh ..... D14/341  
 D667,825 S \* 9/2012 Jung ..... D14/341  
 D668,650 S \* 10/2012 Han ..... D14/341  
 D668,651 S \* 10/2012 Kim et al. .... D14/341  
 D669,468 S \* 10/2012 Akana et al. .... D14/341  
 D669,469 S \* 10/2012 Kang ..... D14/341  
 D670,286 S \* 11/2012 Akana et al. .... D14/341  
 D670,692 S \* 11/2012 Akana et al. .... D14/341  
 D671,514 S \* 11/2012 Kim et al. .... D14/138 G  
 D672,344 S \* 12/2012 Li ..... D14/341  
 D672,345 S \* 12/2012 Li ..... D14/341

D672,768 S \* 12/2012 Huang et al. .... D14/341  
 D673,561 S \* 1/2013 Hyun et al. .... D14/341  
 D673,950 S \* 1/2013 Li et al. .... D14/341  
 D675,203 S \* 1/2013 Yang ..... D14/341  
 D677,181 S \* 3/2013 Lenz et al. .... D10/65  
 D677,255 S \* 3/2013 McManigal et al. .... D14/341  
 D677,660 S \* 3/2013 Groene et al. .... D14/341  
 D678,271 S \* 3/2013 Chiu ..... D14/341  
 2009/0231292 A1 9/2009 Hsieh et al.

FOREIGN PATENT DOCUMENTS

KR 3006004150000 6/2011  
 KR 3006004300000 6/2011  
 KR 3006046440000 7/2011

OTHER PUBLICATIONS

U.S. Appl. No. 29/390,464, Applicant: Kim, et al., filed Apr. 25, 2011, entitled Tablet Computer.  
 U.S. Appl. No. 29/390,462, Applicant Kim et al, filed Apr. 25, 2011, entitled Tablet Computer.  
 U.S. Appl. No. 29/405,537, Applicant Kim et al, filed Nov. 3, 2011, entitled Tablet Computer.  
 U.S. Appl. No. 29/407,981, Applicant Chun et al, filed Dec. 6, 2011, entitled Cradle for Tablet Computer.  
 U.S. Appl. No. 29/407,975, Applicant Chun et al, filed Dec. 6, 2011, entitled Tablet Computer.  
 U.S. Appl. No. 29/407,989, Applicant Lee et al, filed Dec. 6, 2011, entitled Cradle for Tablet Computer.  
 U.S. Appl. No. 29/408,009, Applicant Song et al, filed Dec. 6, 2011, entitled Tablet Computer.  
 U.S. Appl. No. 29/408,996, Applicant Jeon et al., filed Dec. 6, 2011, entitled Charger for Tablet Computer.  
 U.S. Appl. No. 29/407,982, Applicant Lee et al, filed Dec. 6, 2011, entitled Tablet Computer.  
 U.S. Appl. No. 29/407,984, Applicant Jeon et al, filed Dec. 6, 2011, entitled Tablet Computer.

\* cited by examiner

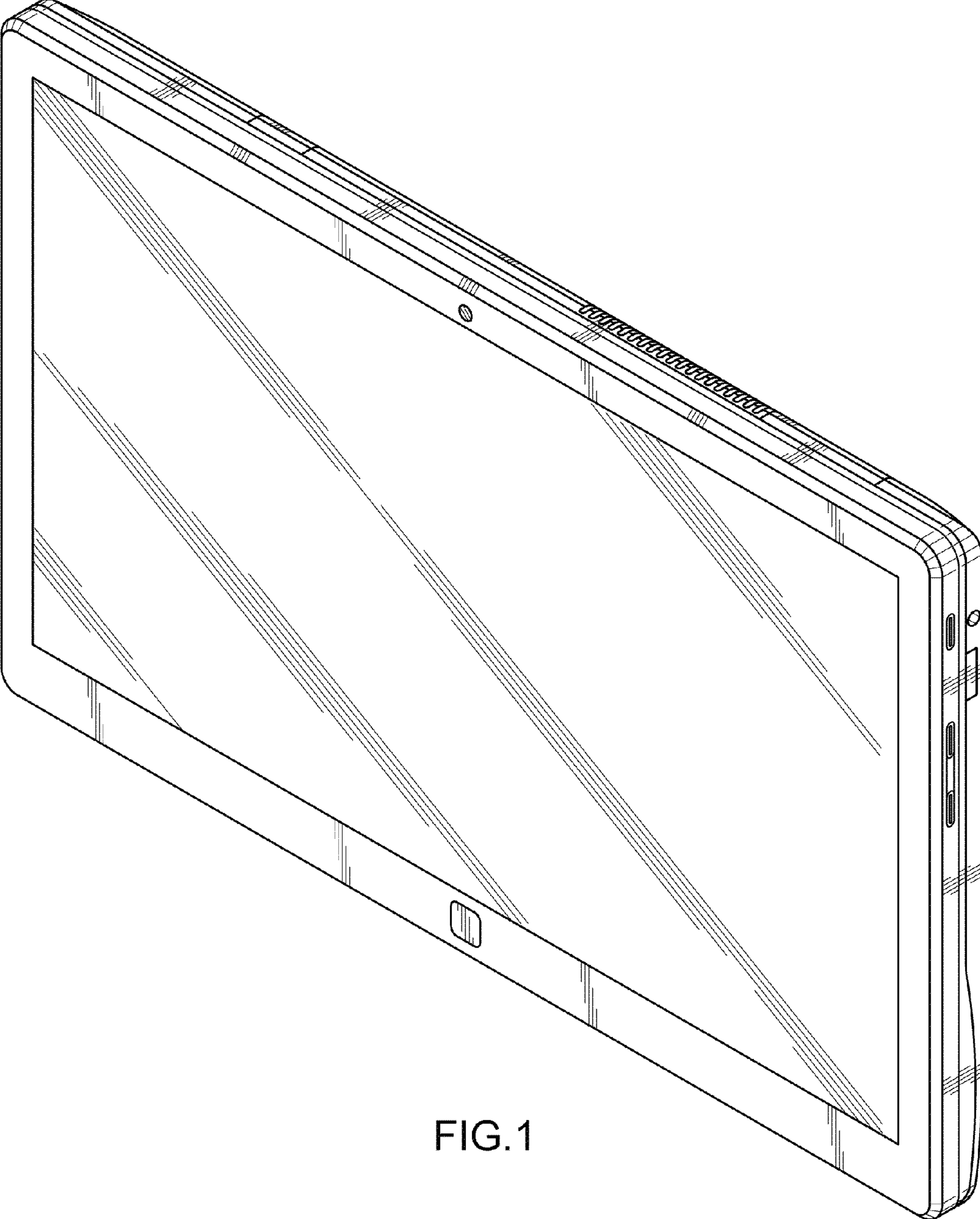

FIG. 1



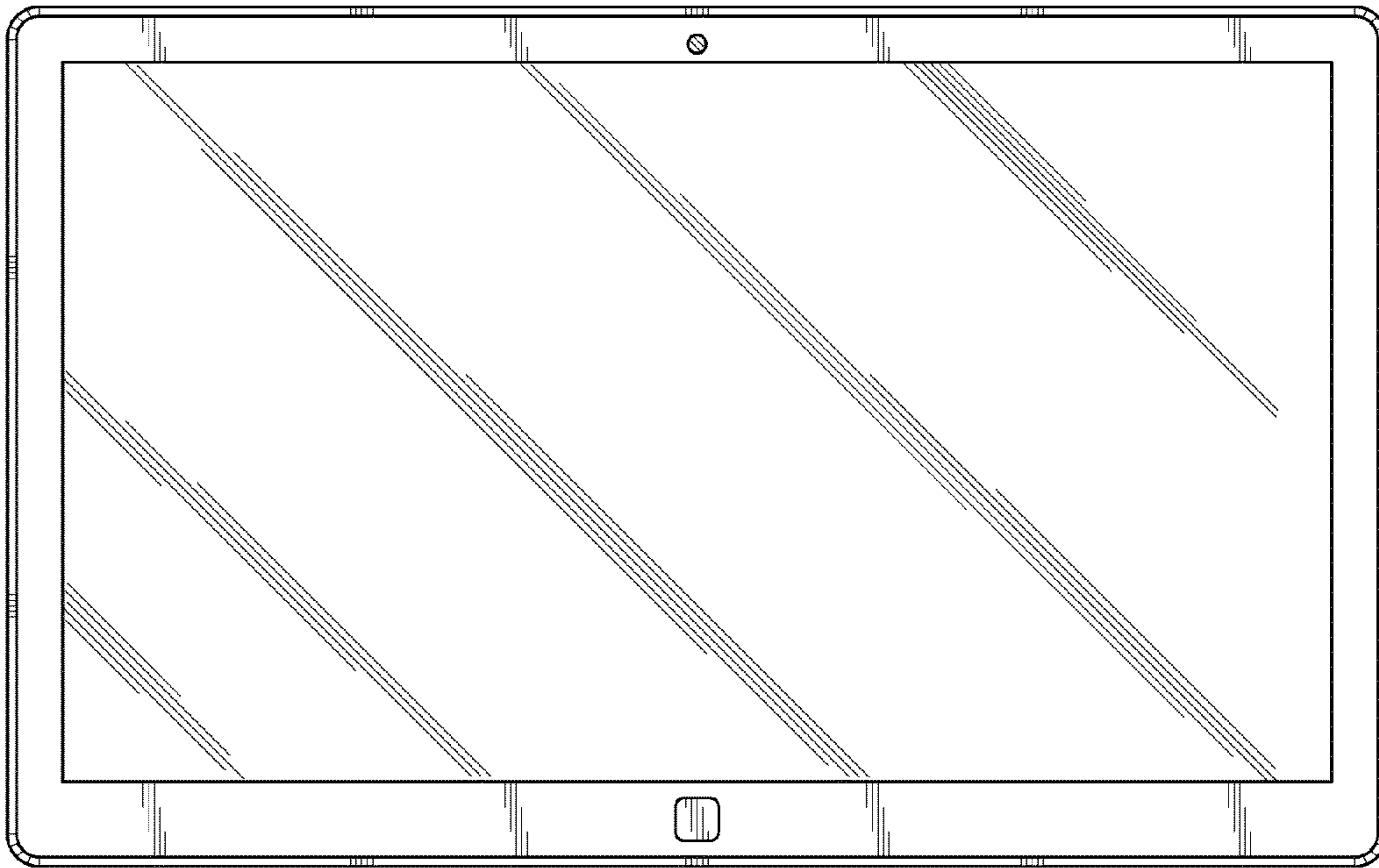

FIG. 2

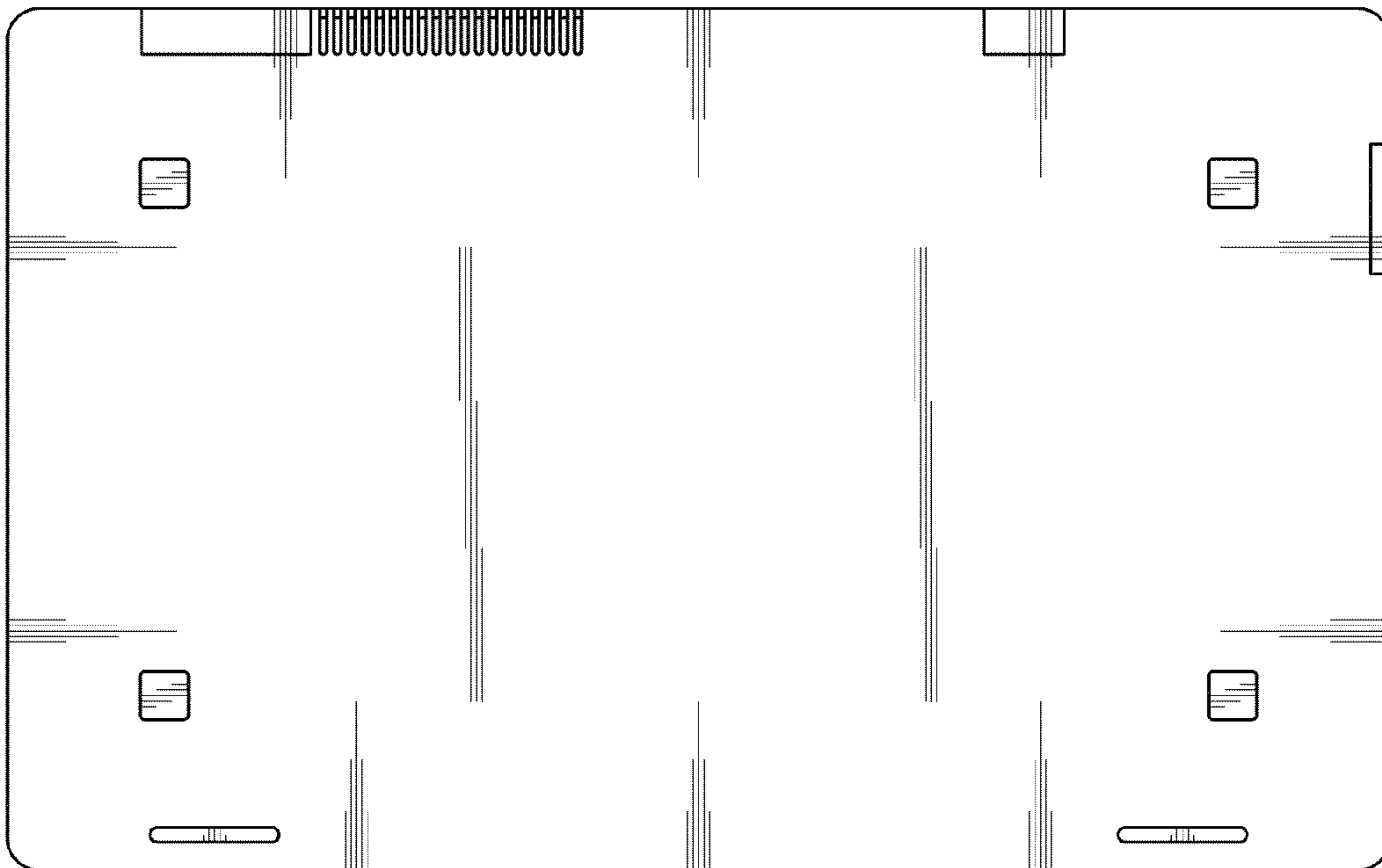

FIG. 3

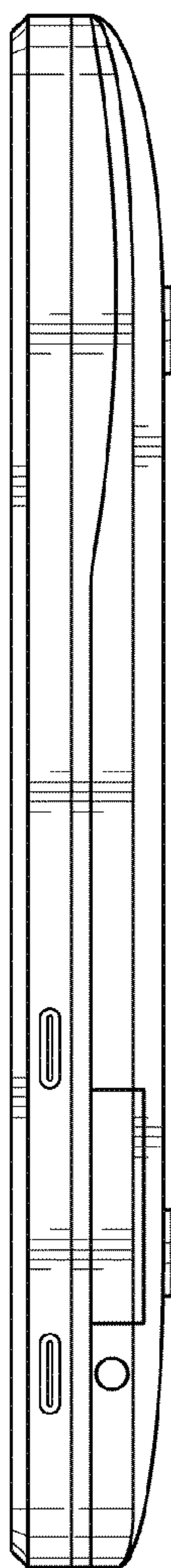

FIG. 4

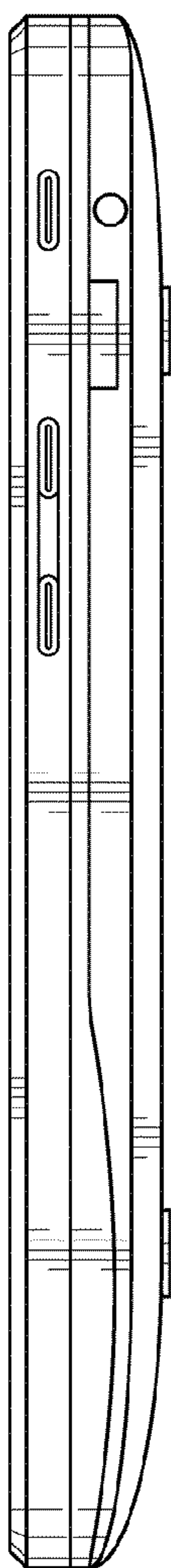

FIG. 5

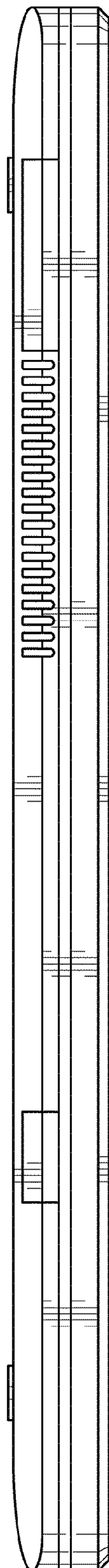

FIG. 6

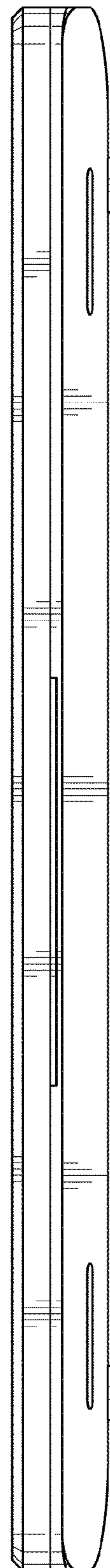

FIG. 7