



US00D687825S

(12) **United States Design Patent**
Lee et al.

(10) **Patent No.:** **US D687,825 S**
(45) **Date of Patent:** **** Aug. 13, 2013**

(54) **TABLET COMPUTER**

(75) Inventors: **EunuaeShally Lee**, Seoul (KR);
Tai-Hyung Ju, Seoul (KR); **Sang-Sung Woo**, Seoul (KR); **So-Yoon Jeon**, Seoul (KR); **Bum-Ho Chun**, Seoul (KR); **Ji-Hee Kwak**, Seoul (KR); **Kil-Hyun Baek**, Seoul (KR)

(73) Assignee: **Samsung Electronics Co., Ltd.**, Suwon-Si (KR)

(**) Term: **14 Years**

(21) Appl. No.: **29/407,982**

(22) Filed: **Dec. 6, 2011**

(30) **Foreign Application Priority Data**

Sep. 27, 2011 (KR) 30-2011-0040004

(51) **LOC (9) Cl.** **14-02**

(52) **U.S. Cl.**
USPC **D14/341**

(58) **Field of Classification Search**
USPC D14/341-347, 137, 138, 138.1, 138 AA, D14/138 R, 138 AB, 138 AD, 138 G, 138 A, D14/496, 426, 429, 129, 130, 420, 439-441, D14/448, 125, 147, 156, 218, 250, 389, 336, D14/203.1, 203.3, 203.4, 203.7, 315; D21/324, D21/329, 330; D10/65, 104; D18/6-7; 345/169, 345/901, 905, 156, 157, 168, 173; 361/814, 361/680, 686, 679.27, 679.3; 341/22; 348/168; 379/433.04, 433.07, 433.11, 916, 433.01, 379/433.06

See application file for complete search history.

(56) **References Cited**

U.S. PATENT DOCUMENTS

D284,084 S 6/1986 Ferrara, Jr.
D306,583 S 3/1990 Krolopp et al.

D333,574 S 3/1993 Ackeret
D337,569 S 7/1993 Kando
D460,759 S * 7/2002 West et al. D14/374
D500,991 S 1/2005 Niitsu
D504,889 S * 5/2005 Andre et al. D14/341
D532,791 S 11/2006 Kim
D563,804 S 3/2008 Kimura et al.
D579,930 S * 11/2008 Maskatia D14/341
D584,738 S 1/2009 Kim et al.
D590,374 S 4/2009 Madonna et al.

(Continued)

FOREIGN PATENT DOCUMENTS

KR 3005985190000 5/2011
KR 3005994750000 5/2011

(Continued)

OTHER PUBLICATIONS

U.S. Appl. No. 29/390,462, Applicant Kim et al, filed Apr. 25, 2011, entitled Tablet Computer.

(Continued)

Primary Examiner — Barbara Fox
(74) *Attorney, Agent, or Firm* — Wood, Herron & Evans, LLP

(57) **CLAIM**
The ornamental design for tablet computer, as shown and described.

DESCRIPTION

FIG. 1 is a top front perspective view of tablet computer showing our new design;
FIG. 2 is a front elevational view thereof;
FIG. 3 is a rear elevational view thereof;
FIG. 4 is a left side elevational view thereof;
FIG. 5 is a right side elevational view thereof;
FIG. 6 is a top plan view thereof; and,
FIG. 7 is a bottom plan view thereof.

1 Claim, 3 Drawing Sheets

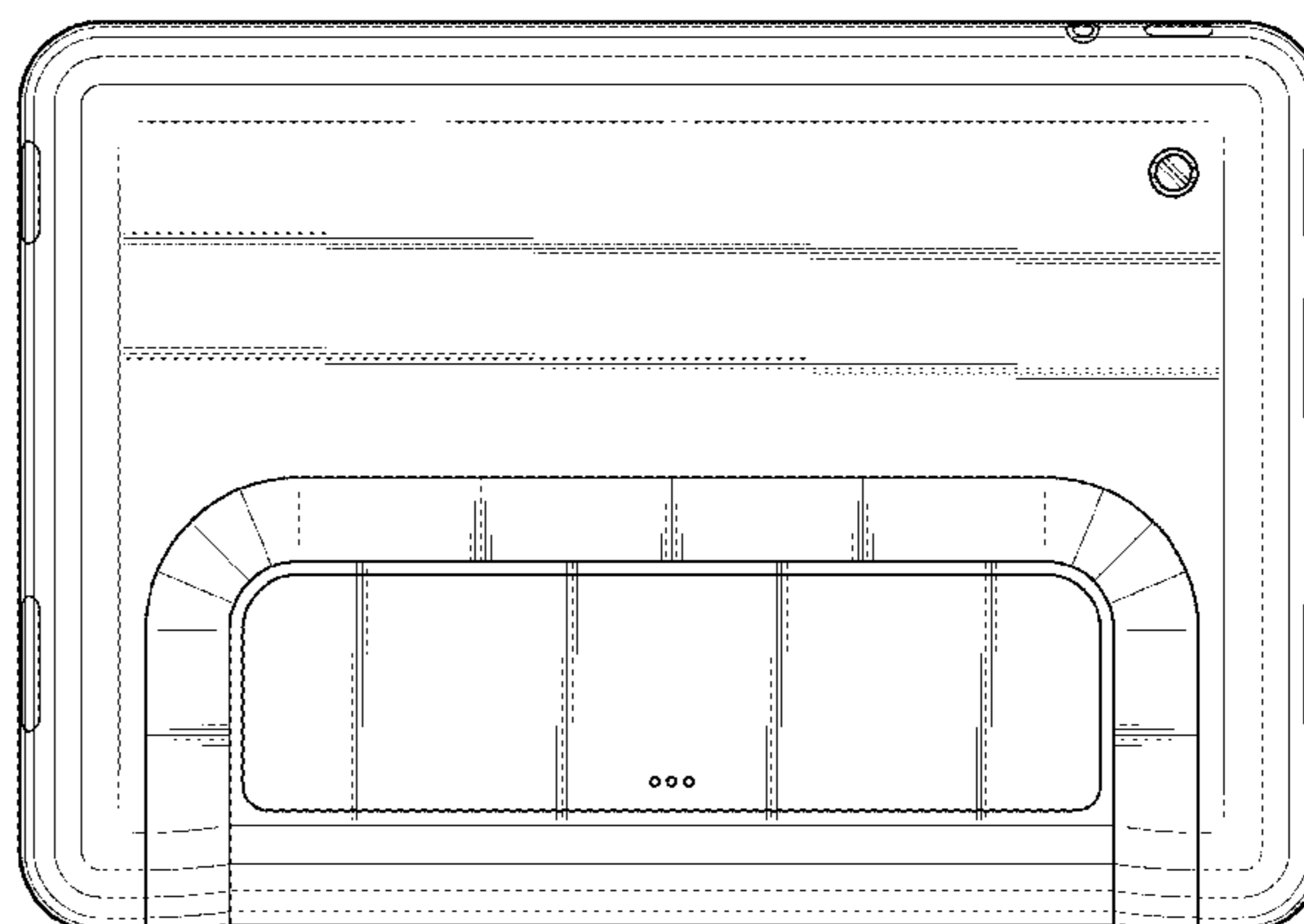
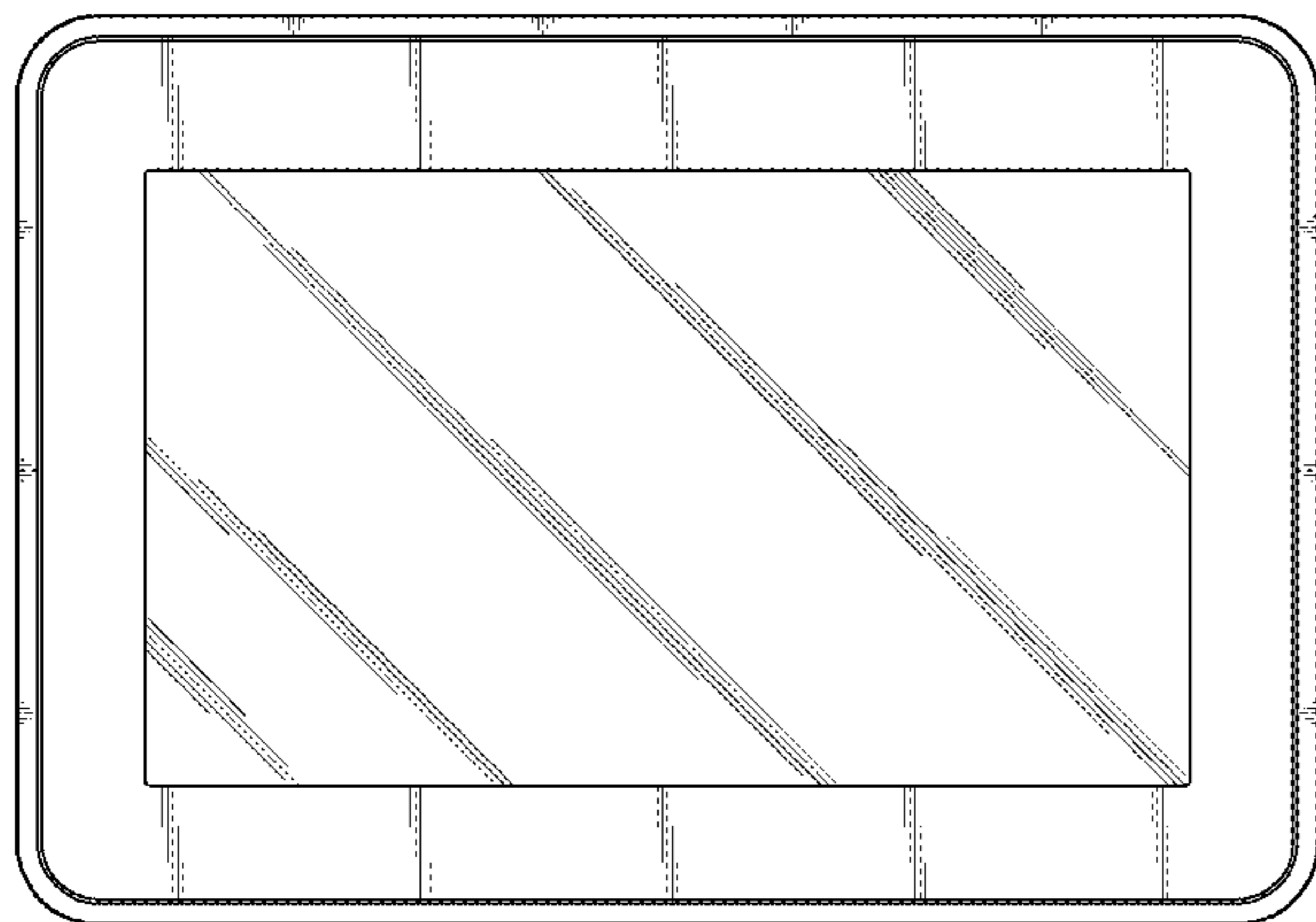

(56)

References Cited

U.S. PATENT DOCUMENTS

D592,214 S 5/2009 Bradford
 D602,014 S 10/2009 Andre et al.
 D602,487 S * 10/2009 Maskatia D14/341
 D605,626 S 12/2009 Park
 D610,582 S 2/2010 Sugitani et al.
 D611,364 S 3/2010 Lenz et al.
 D613,510 S 4/2010 Tzeng et al.
 D613,951 S * 4/2010 Tang et al. D6/308
 D617,793 S * 6/2010 Chiang et al. D14/341
 D622,270 S 8/2010 Andre et al.
 D624,914 S * 10/2010 Wang D14/371
 D627,667 S 11/2010 Lenz et al.
 D628,913 S 12/2010 Cheng
 D629,771 S * 12/2010 Haspil et al. D14/138 G
 D629,799 S 12/2010 Andre et al.
 D631,469 S * 1/2011 Demskie et al. D14/218
 D634,318 S * 3/2011 Buckle et al. D14/341
 D636,391 S * 4/2011 Shen et al. D14/341
 D636,769 S * 4/2011 Wood et al. D14/341
 D636,770 S * 4/2011 Li D14/341
 D639,266 S * 6/2011 DeLorenzo et al. D14/142
 D639,804 S * 6/2011 Hwang et al. D14/341
 D640,255 S 6/2011 Lee et al.
 D641,018 S * 7/2011 Lee et al. D14/341
 D646,902 S * 10/2011 Woo et al. D6/308
 D654,498 S * 2/2012 Hwang et al. D14/341
 D659,692 S * 5/2012 Jung et al. D14/341
 D663,281 S * 7/2012 Hwang D14/138 G
 D663,298 S * 7/2012 Song et al. D14/341
 D664,954 S * 8/2012 Kim et al. D14/341
 D666,198 S * 8/2012 Van Den
 Nieuwenhuizen et al. .. D14/341
 D667,396 S * 9/2012 Koh D14/341
 D667,397 S * 9/2012 Koh D14/341
 D667,398 S * 9/2012 Koh D14/341
 D667,399 S * 9/2012 Koh D14/341
 D667,825 S * 9/2012 Jung D14/341
 D668,650 S * 10/2012 Han D14/341
 D668,651 S * 10/2012 Kim et al. D14/341
 D669,070 S * 10/2012 Hsu et al. D14/341
 D669,468 S * 10/2012 Akana et al. D14/341
 D669,469 S * 10/2012 Kang D14/341
 D670,286 S * 11/2012 Akana et al. D14/341
 D670,692 S * 11/2012 Akana et al. D14/341

D671,514 S * 11/2012 Kim et al. D14/138 G
 D671,938 S * 12/2012 Hsu et al. D14/341
 D672,344 S * 12/2012 Li D14/341
 D672,345 S * 12/2012 Li D14/341
 D672,768 S * 12/2012 Huang et al. D14/341
 D673,561 S * 1/2013 Hyun et al. D14/341
 D673,950 S * 1/2013 Li et al. D14/341
 D674,384 S * 1/2013 Zhang D14/341
 D675,203 S * 1/2013 Yang D14/341
 D677,181 S * 3/2013 Lenz et al. D10/65
 D677,255 S * 3/2013 McManigal et al. D14/341
 D677,660 S * 3/2013 Groene et al. D14/341
 D678,271 S * 3/2013 Chiu D14/341
 2009/0231292 A1 9/2009 Hsieh et al.

FOREIGN PATENT DOCUMENTS

KR 3006004150000 6/2011
 KR 3006004300000 6/2011
 KR 3006046440000 7/2011

OTHER PUBLICATIONS

U.S. Appl. No. 29/390,463, Applicant: Kim, et al., filed Apr. 25, 2011
 entitled Tablet Computer.
 U.S. Appl. No. 29/390,464, Applicant: Kim, et al., filed Apr. 25, 2011
 entitled Tablet Computer.
 U.S. Appl. No. 29/405,537, Applicant Kim et al, filed Nov. 3, 2011,
 entitled Tablet Computer.
 U.S. Appl. No. 29/407,981, Applicant Chun et al, filed Dec. 6, 2011,
 entitled Cradle for Tablet Computer.
 U.S. Appl. No. 29/407,989, Applicant Lee et al, filed Dec. 6, 2011,
 entitled Cradle for Tablet Computer.
 U.S. Appl. No. 29/407,996, Applicant Jeon et al, filed Dec. 6, 2011,
 entitled Charger for Tablet Computer.
 U.S. Appl. No. 29/408,009, Applicant Song et al, filed Dec. 6, 2011,
 entitled Tablet Computer.
 U.S. Appl. No. 29/408,017, Applicant Song et al, filed Dec. 6, 2011,
 entitled Tablet Computer.
 U.S. Appl. No. 29/407,975, Applicant Chun et al, filed Dec. 6, 2011,
 entitled Tablet Computer.
 U.S. Appl. No. 29/407,984, Applicant Jeon et al, filed Dec. 6, 2011,
 entitled Tablet Computer.

* cited by examiner

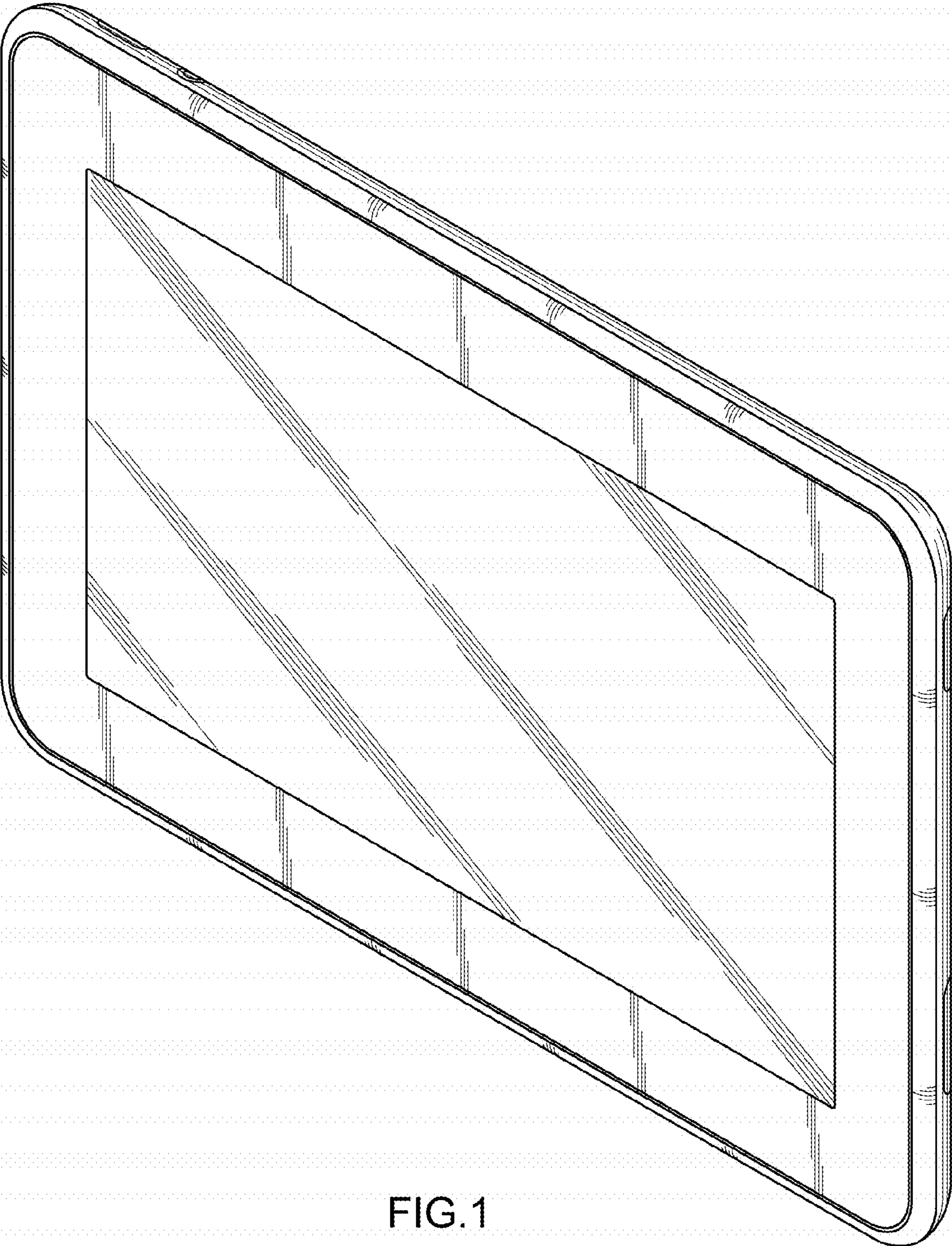

FIG. 1

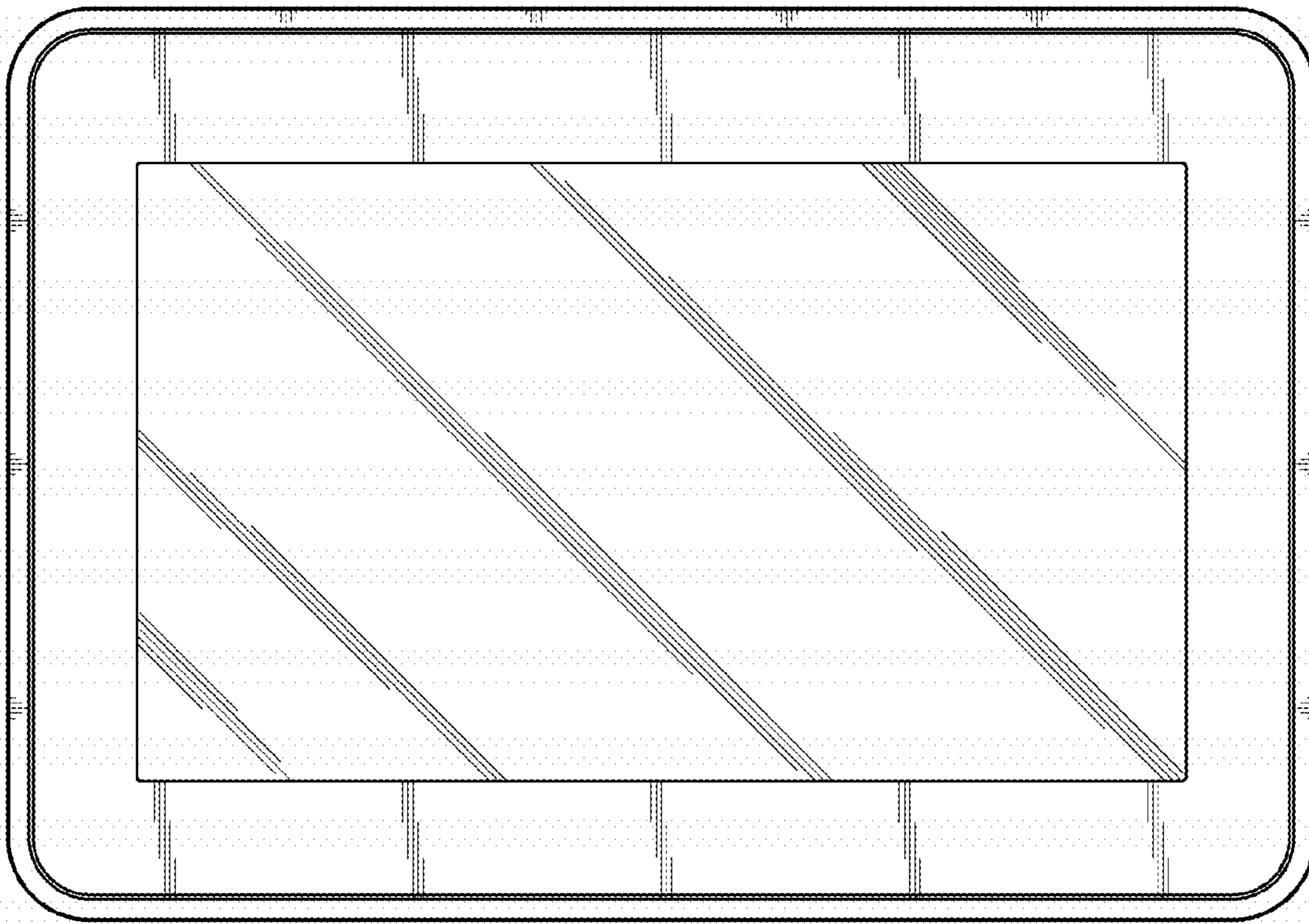

FIG. 2

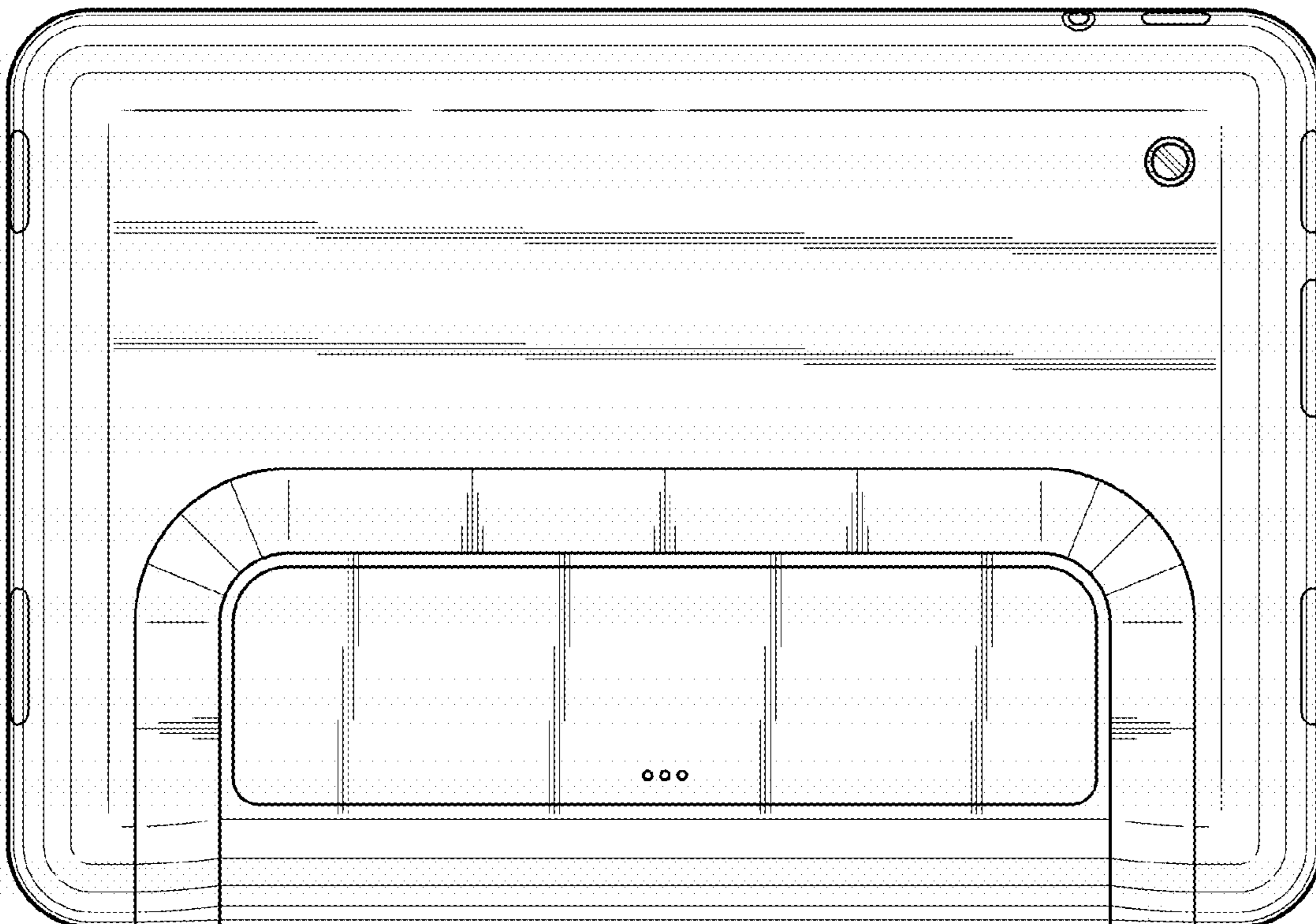

FIG. 3

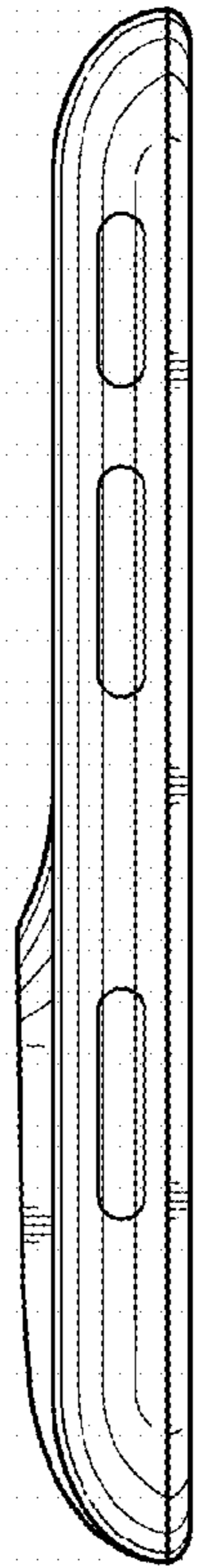

FIG. 4

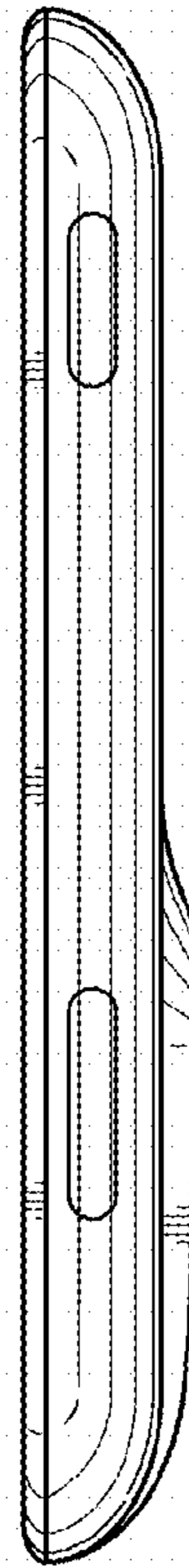

FIG. 5



FIG. 6

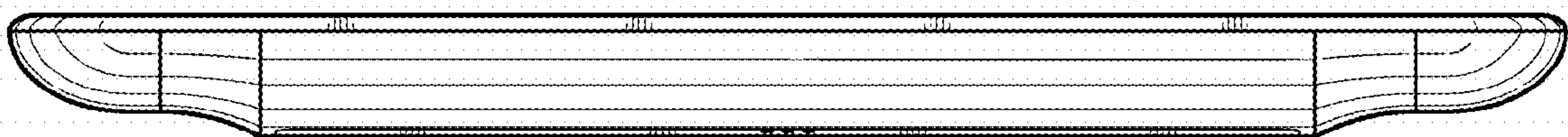

FIG. 7