



US00D687804S

(12) **United States Design Patent**  
**Park**

(10) **Patent No.:** **US D687,804 S**

(45) **Date of Patent:** **\*\* Aug. 13, 2013**

(54) **MOBILE PHONE**

(75) Inventor: **Dae-Yoeb Park**, Gimpo-si (KR)

(73) Assignee: **Samsung Electronics Co., Ltd.**,  
Suwon-Si (KR)

(\*\*) Term: **14 Years**

(21) Appl. No.: **29/431,760**

(22) Filed: **Sep. 11, 2012**

(30) **Foreign Application Priority Data**

May 23, 2012 (KR) ..... 30-2012-0025412

(51) **LOC (9) Cl.** ..... **14-03**

(52) **U.S. Cl.**  
USPC ..... **D14/138 G**

(58) **Field of Classification Search**

USPC ..... D14/138 G, 138 AD, 341, 346, 138 R,  
D14/138 AC, 496, 203.1, 203.4, 203.7, 248,  
D14/218; 455/575.1, 556.2, 575.3, 575.4;  
D21/517; 379/433.01, 433.04; D10/65, 78,  
D10/104; D13/168

See application file for complete search history.

(56) **References Cited**

U.S. PATENT DOCUMENTS

- D589,924 S \* 4/2009 Jung et al. .... D14/138 AD
- D601,535 S \* 10/2009 Huang ..... D14/138 AD
- D611,924 S \* 3/2010 Ou et al. .... D14/138 AD
- D615,519 S \* 5/2010 Kim et al. .... D14/138 G
- D618,200 S \* 6/2010 Kim et al. .... D14/138 AD
- D621,378 S \* 8/2010 Kim et al. .... D14/138 AD
- D629,776 S \* 12/2010 Lee et al. .... D14/138 AD
- D631,464 S \* 1/2011 Kim ..... D14/138 G
- D631,864 S \* 2/2011 Jung ..... D14/138 AB
- D632,273 S \* 2/2011 Lim et al. .... D14/138 AD
- D633,066 S \* 2/2011 Park et al. .... D14/138 AD

(Continued)

OTHER PUBLICATIONS

Samsung M930 Transform Ultra telephone, announced Sep. 2011, [online], [site visited Mar. 19, 2013]. Available from Internet, <URL: [http://www.gsmarena.com/samsung\\_m930\\_transform\\_ultra-4270.php](http://www.gsmarena.com/samsung_m930_transform_ultra-4270.php)>.\*

(Continued)

*Primary Examiner* — Jeffrey D Asch

(74) *Attorney, Agent, or Firm* — Staas & Halsey LLP

(57) **CLAIM**

The ornamental design for a mobile phone, as shown and described.

**DESCRIPTION**

FIG. 1 is a front perspective view of a mobile phone; FIG. 2 is a front view of the mobile phone of FIG. 1; FIG. 3 is a rear view of the mobile phone of FIG. 1; FIG. 4 is a left-side view of the mobile phone of FIG. 1; FIG. 5 is a right-side view of the mobile phone of FIG. 1; FIG. 6 is a top plan view of the mobile phone of FIG. 1; FIG. 7 is a bottom plan view of the mobile phone of FIG. 1; and, FIG. 8 is an open front perspective view of the mobile phone of FIG. 1.

The broken lines shown in the figures that are immediately adjacent to the shaded areas and define regions that are consistently unshaded, represent the bounds of the claim, while all other broken lines, including those beneath the transparent panel on the front, are directed to environment and are for illustrative purposes only; the broken lines, as well as the entire keypad area defined by a solid line in FIG. 8, form no part of the claimed design.

**1 Claim, 8 Drawing Sheets**

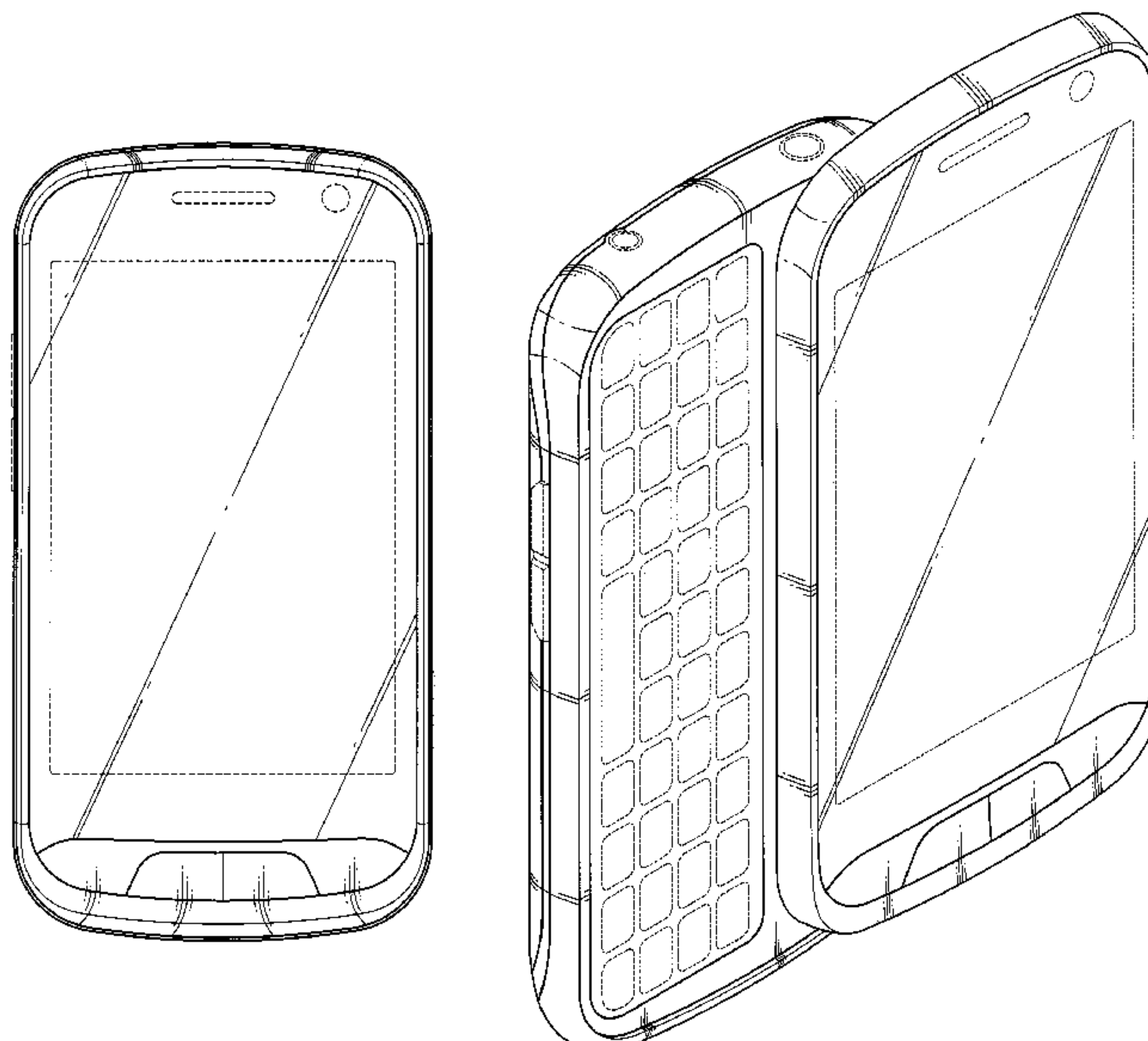

U.S. PATENT DOCUMENTS

D636,368	S	*	4/2011	Kim	.....	D14/138	AD
D639,767	S	*	6/2011	Finney et al.	.....	D14/138	G
D642,152	S	*	7/2011	Cho	.....	D14/138	AD
D646,252	S	*	10/2011	Kim et al.	.....	D14/138	AD
D651,188	S	*	12/2011	Sugiyama	.....	D14/138	AD
D654,894	S	*	2/2012	Kim	.....	D14/138	G
D657,763	S	*	4/2012	Kim	.....	D14/138	AD
D658,148	S	*	4/2012	Park	.....	D14/138	AD
D659,667	S	*	5/2012	Jung et al.	.....	D14/138	AD
D665,764	S	*	8/2012	Shi et al.	.....	D14/138	G
8,249,677	B2	*	8/2012	Shih et al.	.....	455/575.4	
D669,052	S	*	10/2012	Kim et al.	.....	D14/138	G
D673,537	S	*	1/2013	Kim et al.	.....	D14/247	
2011/0059774	A1	*	3/2011	Clift et al.	.....	455/566	

OTHER PUBLICATIONS

LG Enlighten VS700 telephone, announced Sep. 2011, [online], [site visited Mar. 19, 2013]. Available from Internet, <URL: [http://www.gsmarena.com/lg\\_enlighten\\_vs700-4352.php](http://www.gsmarena.com/lg_enlighten_vs700-4352.php)>.\*

HTC Touch Pro2 telephone, announced Feb. 2009, [online], [site visited Mar. 19, 2013]. Available from Internet, <URL: [http://www.gsmarena.com/htc\\_touch\\_pro2-2690.php](http://www.gsmarena.com/htc_touch_pro2-2690.php)>.\*

LG Optimus Net Dual telephone, announced Q3 2011, [online], [site visited Mar. 19, 2013]. Available from Internet, <URL: [http://www.gsmarena.com/lg\\_optimus\\_net\\_dual-4309.php](http://www.gsmarena.com/lg_optimus_net_dual-4309.php)>.\*

Pantech Breakout telephone, announced Jul. 2011, [online], [site visited Mar. 19, 2013]. Available from Internet, <URL: [http://www.gsmarena.com/pantech\\_breakout-4294.php](http://www.gsmarena.com/pantech_breakout-4294.php)>.\*

Celkon A88 telephone, announced 2012, [online], [site visited Mar. 19, 2013]. Available from Internet, <URL: [http://www.gsmarena.com/celkon\\_a88-4704.php](http://www.gsmarena.com/celkon_a88-4704.php)>.\*

LG Wink Style T310 telephone, announced Aug. 2010, [online], [site visited Mar. 19, 2013]. Available from Internet, <URL: [http://www.gsmarena.com/lg\\_wink\\_style\\_t310-3411.php](http://www.gsmarena.com/lg_wink_style_t310-3411.php)>.\*

\* cited by examiner

FIG. 1

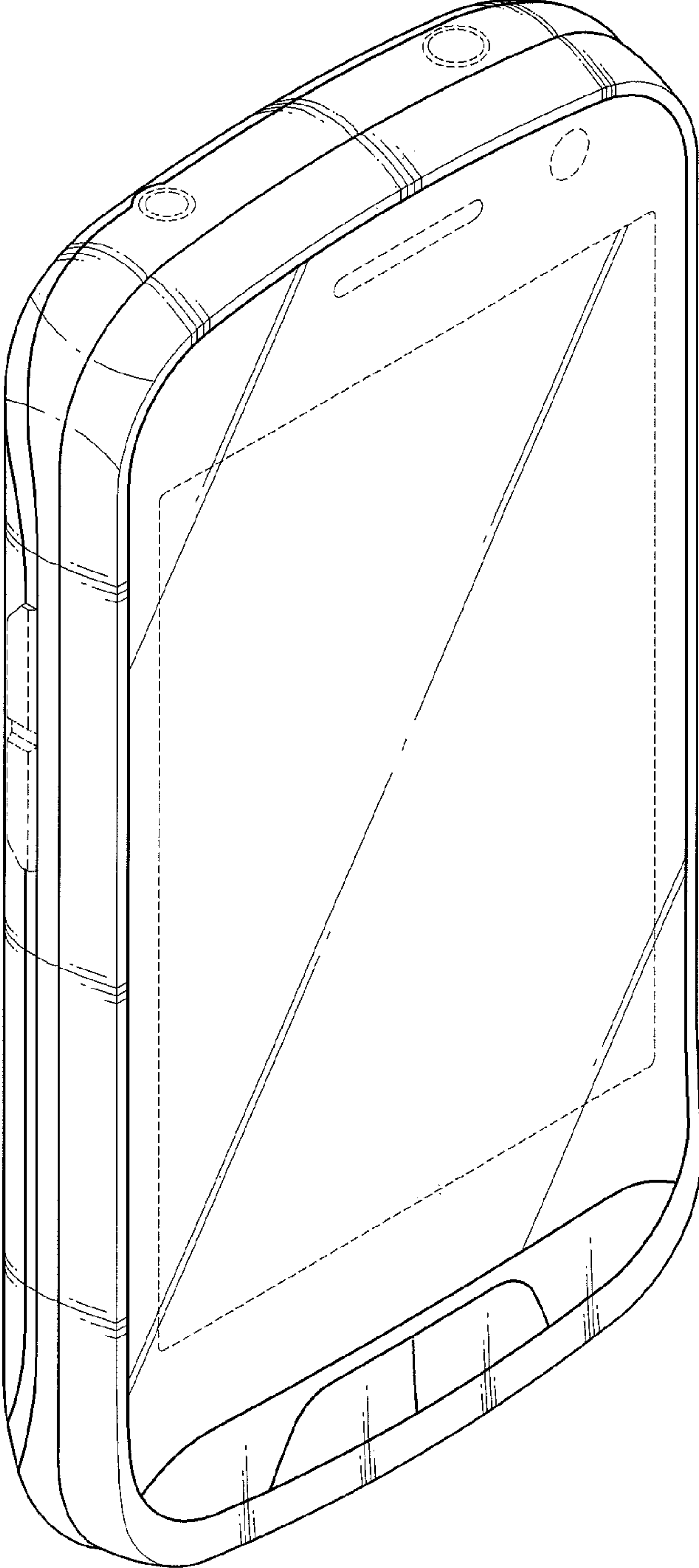

FIG. 2

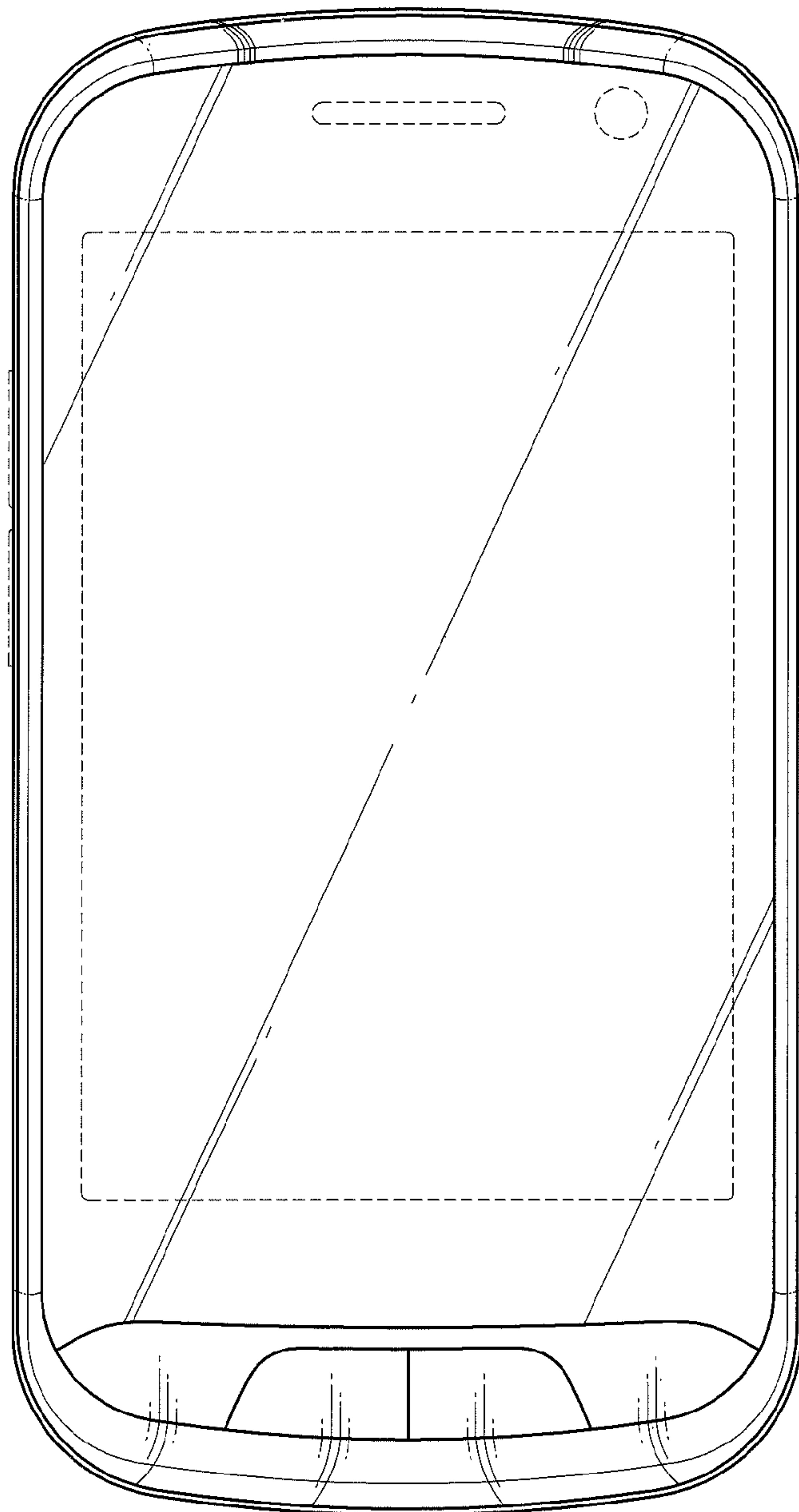

FIG. 3

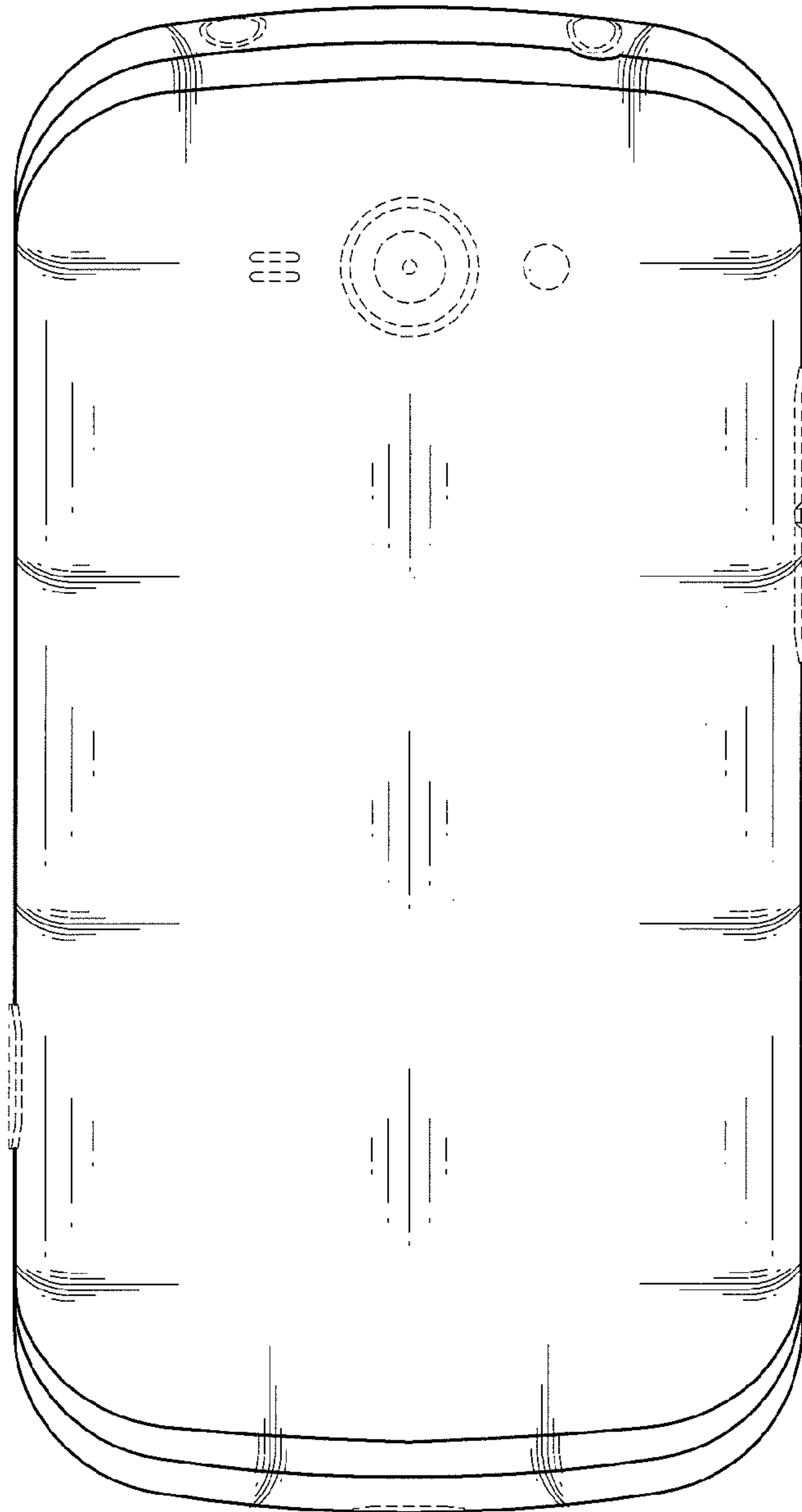



FIG. 4

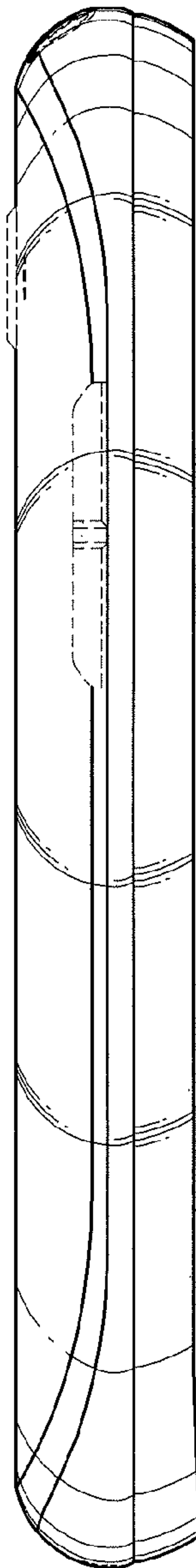

FIG. 5

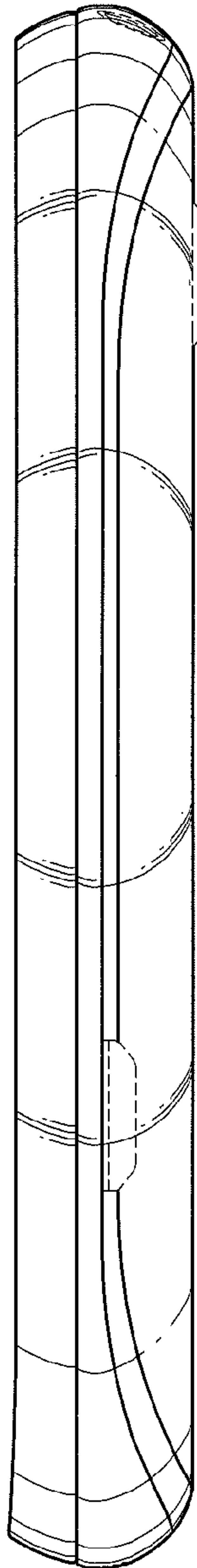

FIG. 6

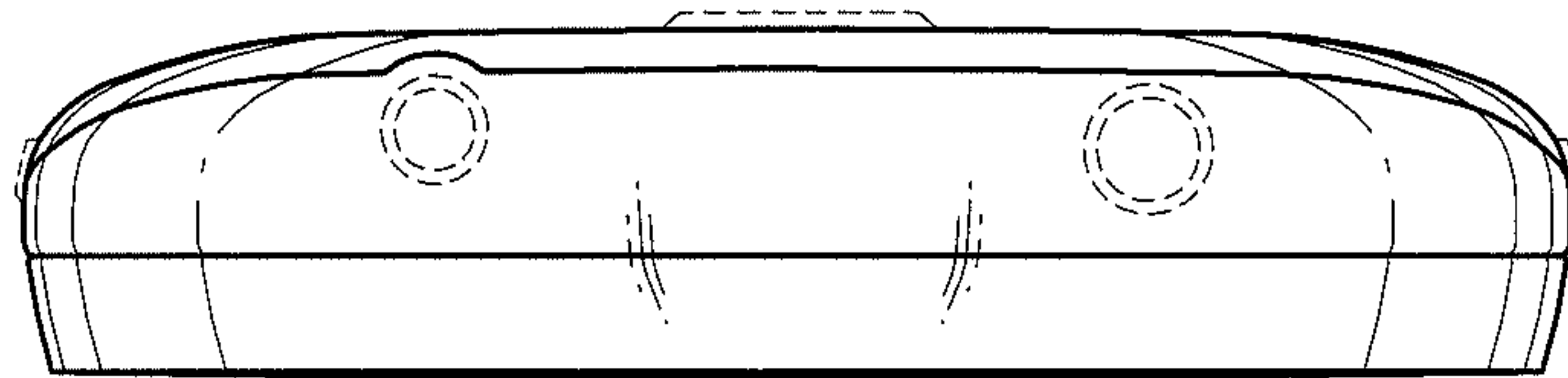



FIG. 7

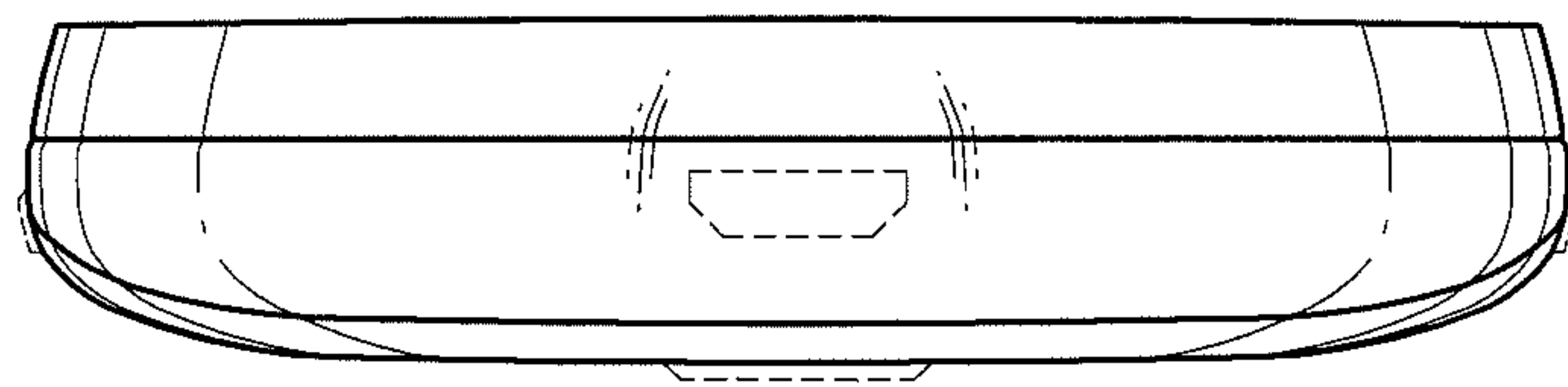

FIG. 8

