



US00D687600S

(12) **United States Design Patent**
Cheng

(10) **Patent No.:** **US D687,600 S**

(45) **Date of Patent:** **** Aug. 6, 2013**

(54) **ULTRAVIOLET NAIL CURING DEVICE**

D545,973 S * 7/2007 Powell et al. D24/209

(75) Inventor: **Kuo-Chang Cheng**, New Taipei (TW)

* cited by examiner

(73) Assignee: **Cosmex Co., Ltd.**, New Taipei (TW)

Primary Examiner — Jennifer Rivard

(**) Term: **14 Years**

(57) **CLAIM**

I claim the ornamental design for an ultraviolet nail curing device, as shown and described.

(21) Appl. No.: **29/431,061**

DESCRIPTION

(22) Filed: **Sep. 1, 2012**

(51) **LOC (9) Cl.** **28-03**

(52) **U.S. Cl.**

USPC **D28/58**; D28/54.1

(58) **Field of Classification Search**

USPC . D28/54.1, 56–58; 250/492.1, 504 R–504 H;
D24/210; 34/275, 202, 90; 132/73–76.5

See application file for complete search history.

FIG. 1 is a perspective view of an ultraviolet nail curing device showing my new design;

FIG. 2 is a front elevational view thereof;

FIG. 3 is a rear elevational view thereof;

FIG. 4 is a left elevational view thereof;

FIG. 5 is a right elevational view thereof;

FIG. 6 is a top view thereof;

FIG. 7 is a bottom view thereof; and,

FIG. 8 is a perspective view of the ultraviolet nail curing device showing a state of use thereof.

The broken lines shown in the drawings illustrate portions of the article and form no part of the claimed design.

(56) **References Cited**

U.S. PATENT DOCUMENTS

D442,286 S * 5/2001 Dumas D24/210

D453,858 S * 2/2002 Tsai D28/58

1 Claim, 8 Drawing Sheets

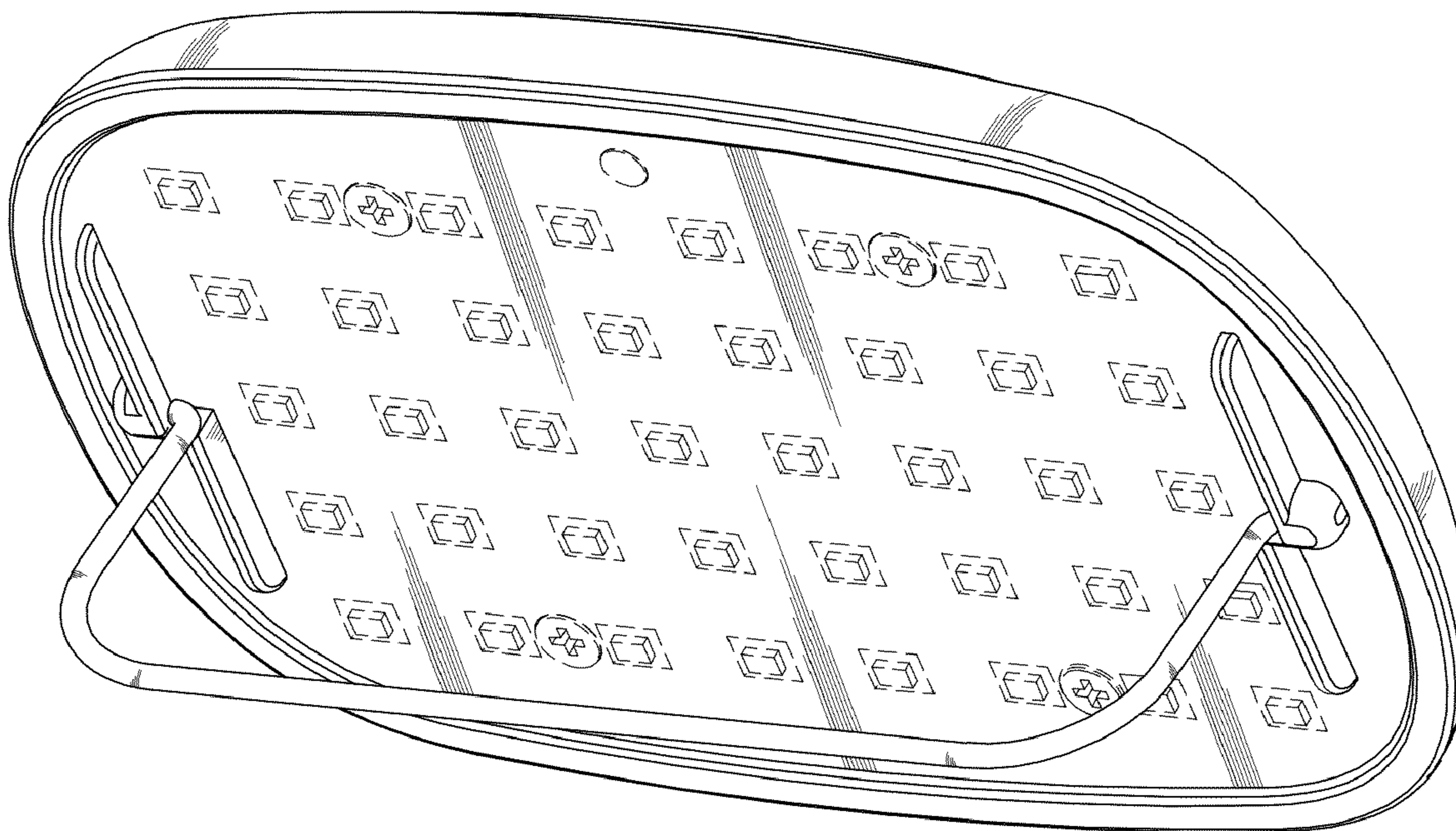

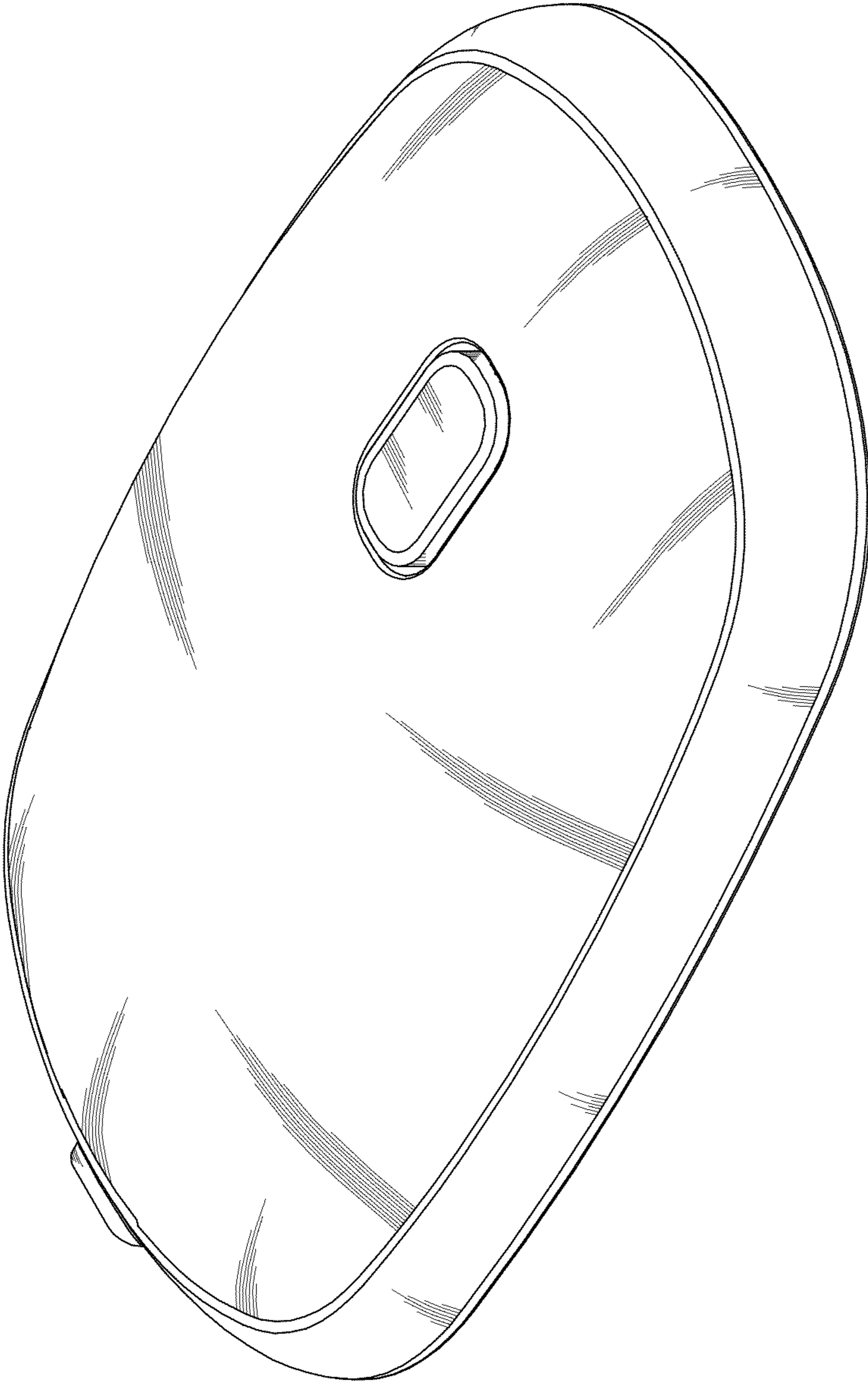

FIG. 1

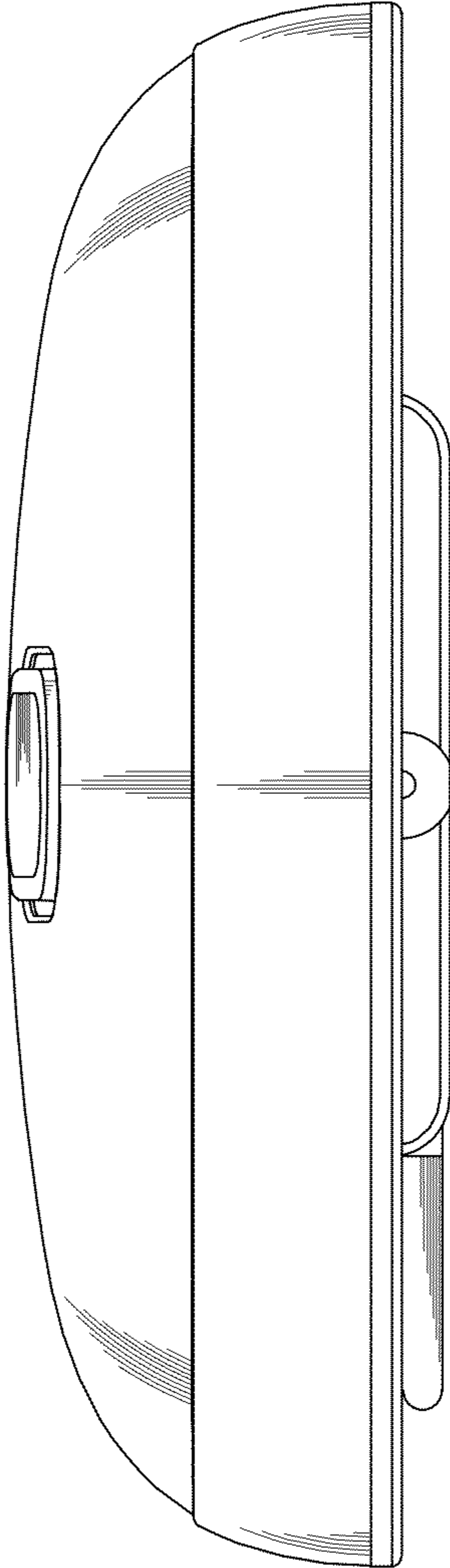

FIG. 2

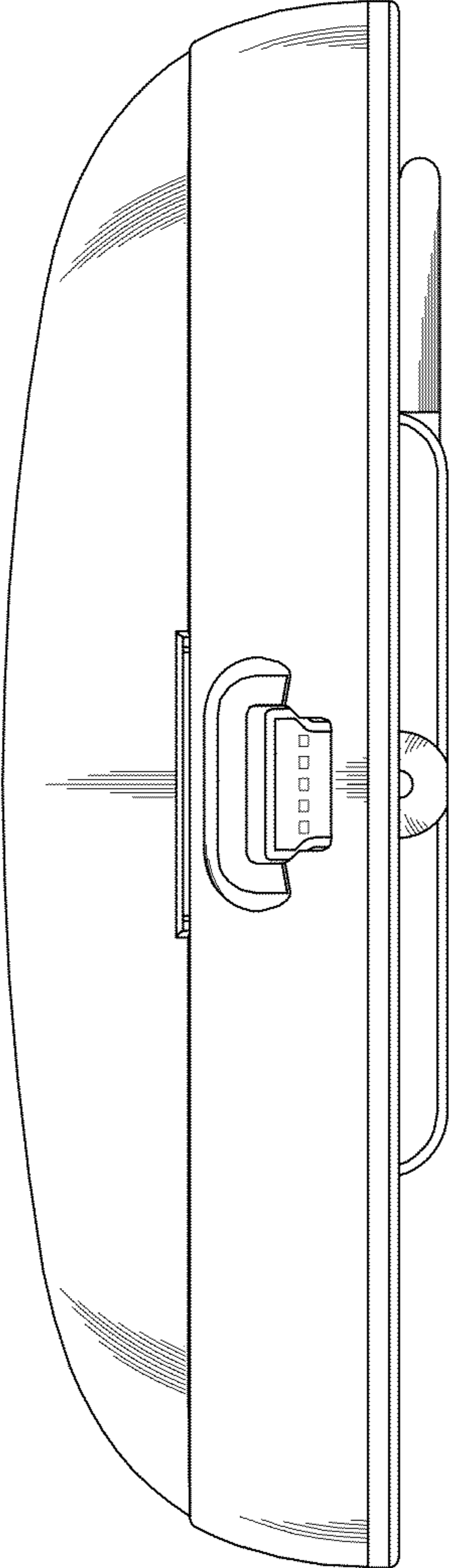

FIG. 3

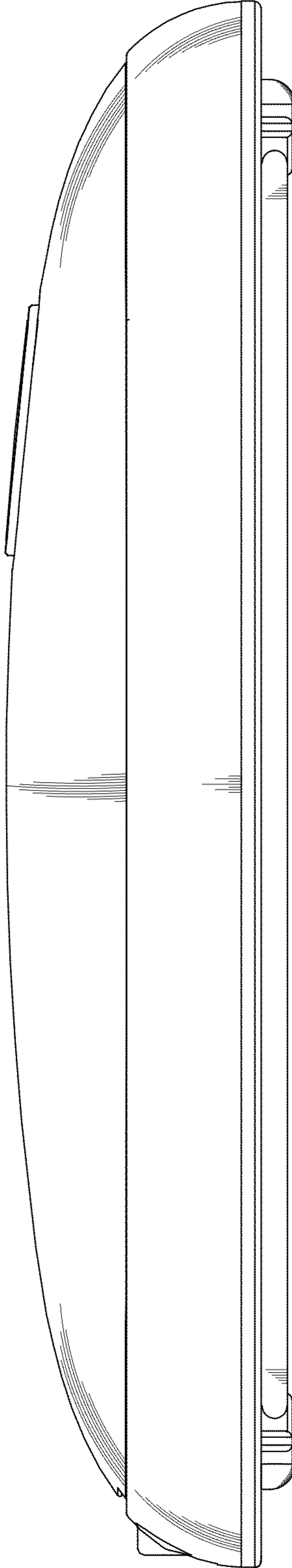

FIG. 4

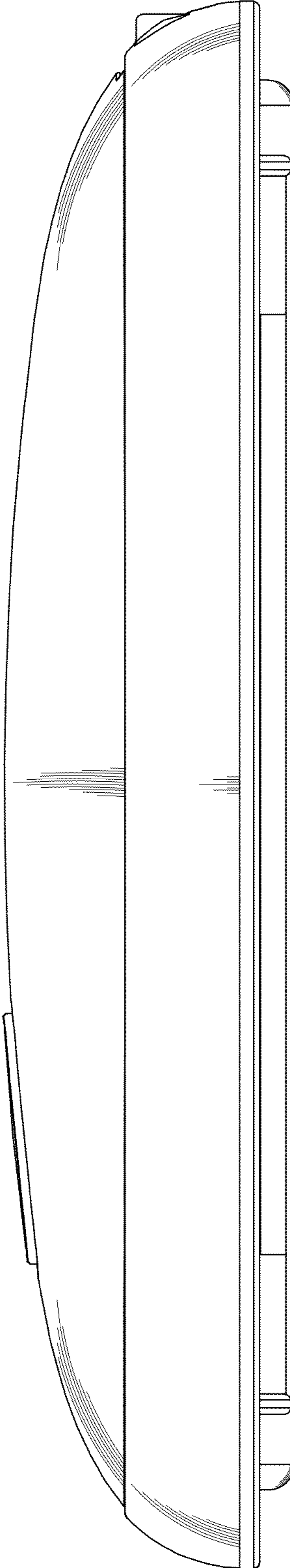

FIG. 5

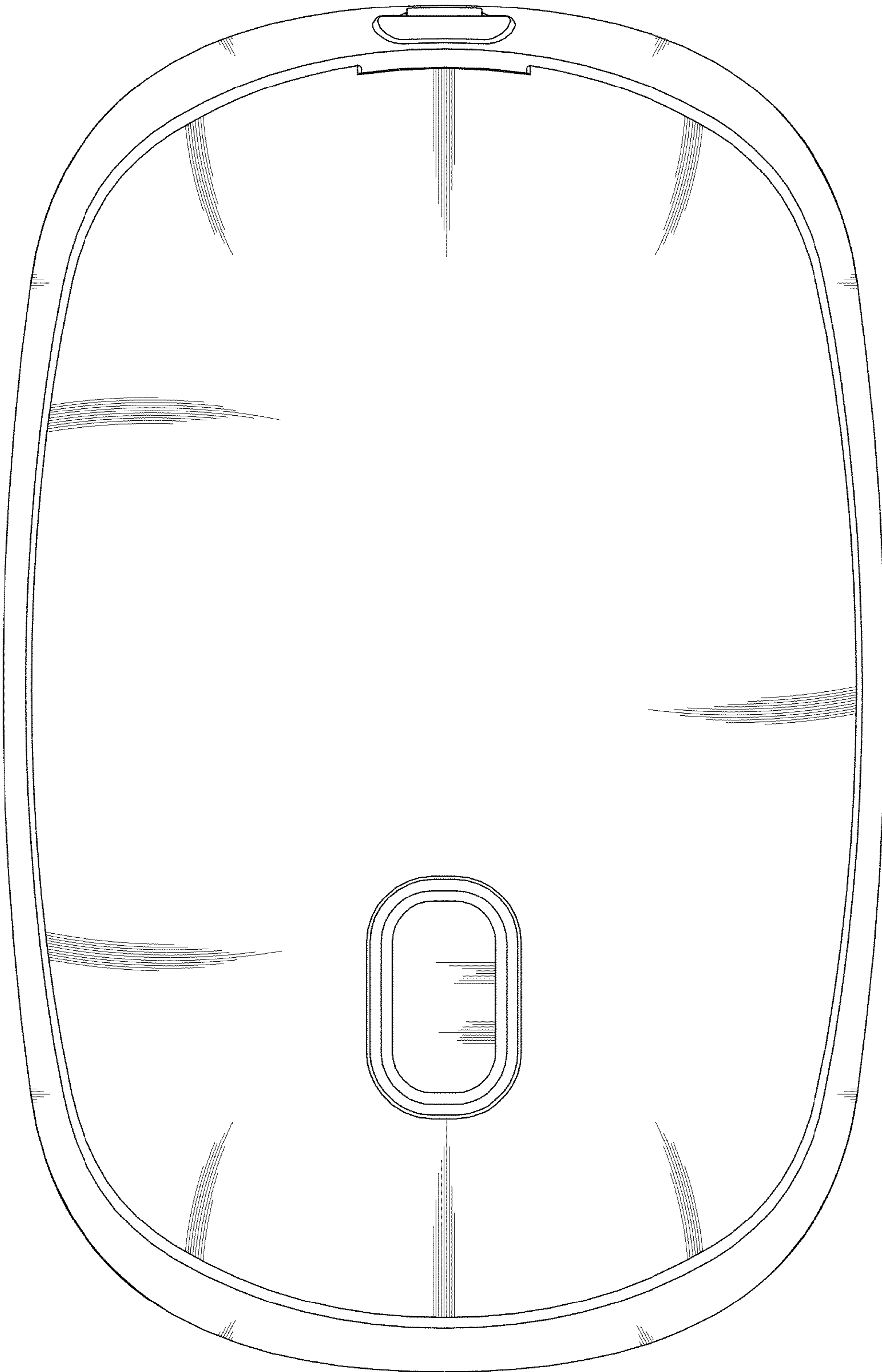

FIG. 6

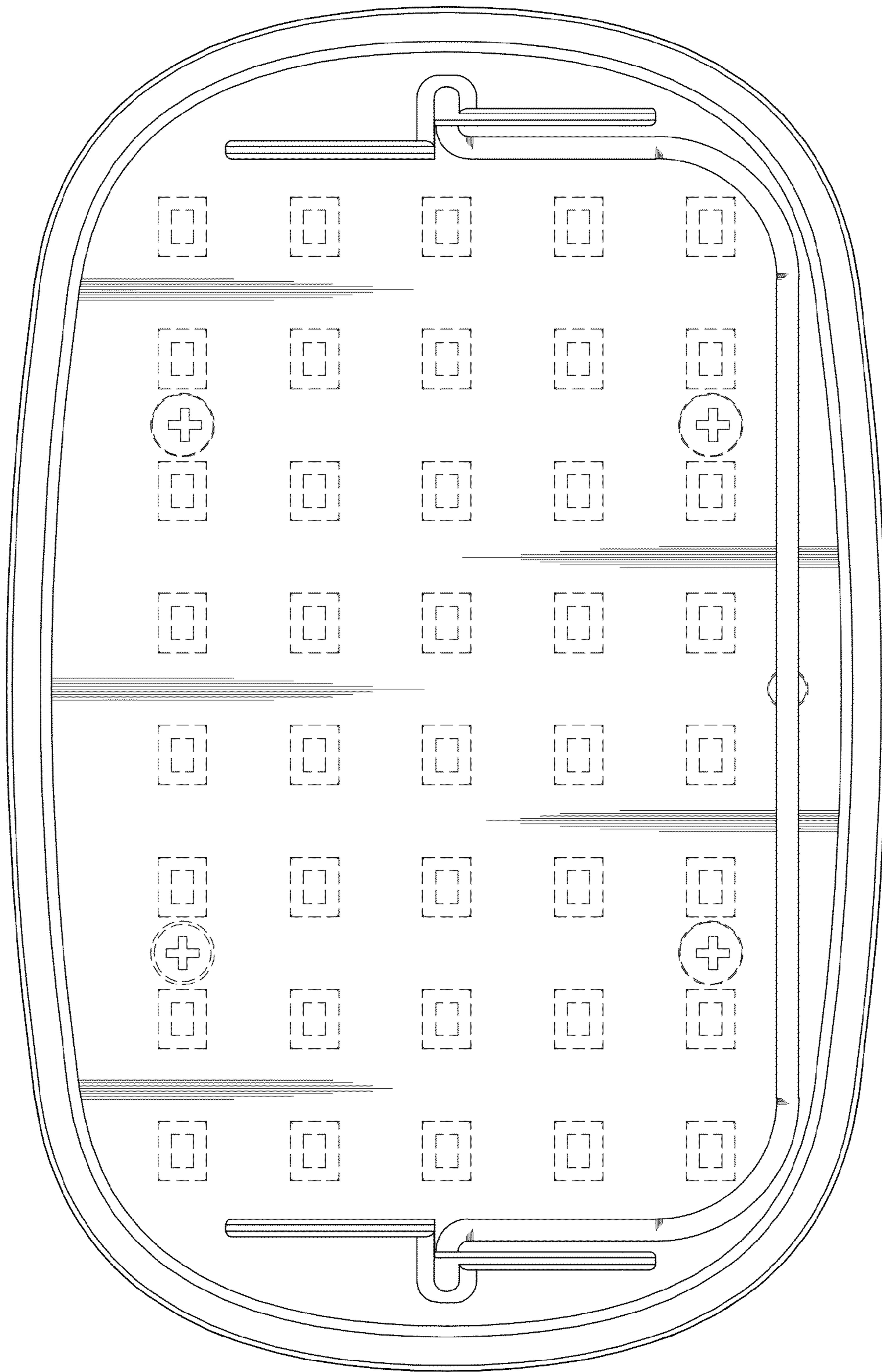

FIG. 7

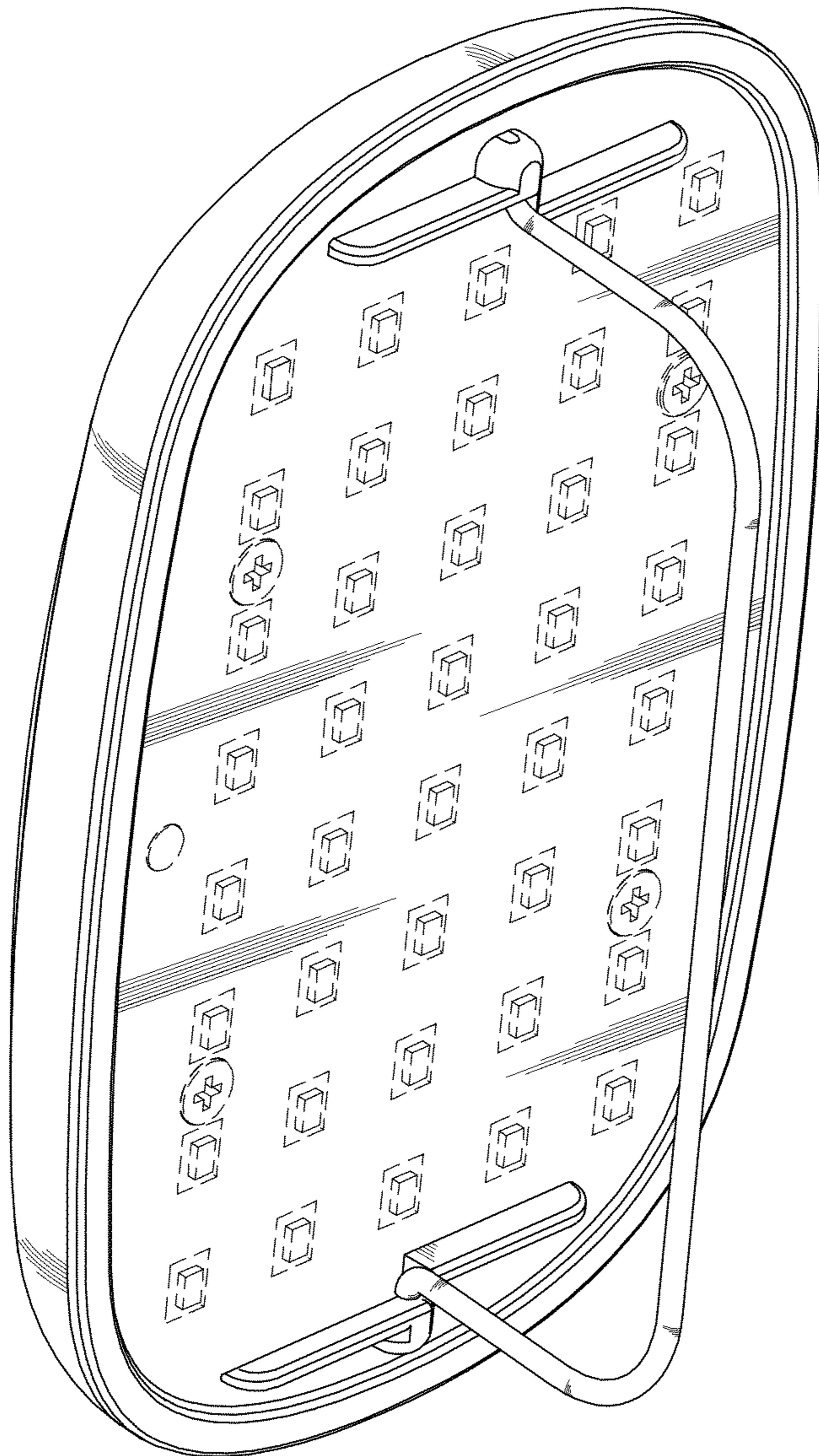

FIG. 8