



US00D687593S

(12) **United States Design Patent**  
**Giesbrecht**

(10) **Patent No.:** **US D687,593 S**  
(45) **Date of Patent:** **\*\* Aug. 6, 2013**

- (54) **LIGHT BEZEL FOR A BUS**
- (75) Inventor: **Timothy Giesbrecht**, Winnipeg (CA)
- (73) Assignee: **New Flyer Industries Canada ULC**,  
Winnipeg, Manitoba
- (\*\*) Term: **14 Years**
- (21) Appl. No.: **29/387,364**
- (22) Filed: **Mar. 11, 2011**

**Related U.S. Application Data**

- (63) Continuation-in-part of application No. 29/332,861, filed on Feb. 26, 2009, now Pat. No. Des. 639,712, and a continuation-in-part of application No. 29/331,953, filed on Feb. 5, 2009, now Pat. No. Des. 637,520.
- (51) **LOC (9) Cl.** ..... **26-99**
- (52) **U.S. Cl.**  
USPC ..... **D26/139**
- (58) **Field of Classification Search**  
USPC ..... D26/28-36, 139; 362/61, 80-83,  
362/459-468, 475-478, 485-487  
See application file for complete search history.

(56) **References Cited**

**U.S. PATENT DOCUMENTS**

D421,817 S *	3/2000	Tucker et al.	.....	D26/139
D527,123 S *	8/2006	Beigel et al.	.....	D26/28
D529,223 S *	9/2006	Beigel et al.	.....	D26/139
D661,012 S *	5/2012	Parkes et al.	.....	D26/139

\* cited by examiner

*Primary Examiner* — Marcus Jackson

(74) *Attorney, Agent, or Firm* — Norton Rose Fulbright Canada LLP

(57) **CLAIM**

We claim the ornamental design for light bezel for a bus, as shown and described.

**DESCRIPTION**

FIG. 1 is a top, rear and left perspective view of a light bezel for a bus showing our new design;

FIG. 2 is a top view of one of the embodiments of FIG. 1;  
 FIG. 3 is a rear elevation view of the embodiment of FIG. 2;  
 FIG. 4 is a left elevation view of the embodiment of FIG. 2;  
 FIG. 5 is a top, rear, and left side isometric view of the embodiment of FIG. 2;  
 FIG. 6 is a top, front, and right side isometric view of the embodiment of FIG. 2;  
 FIG. 7 is a top view of the other embodiment of FIG. 1;  
 FIG. 8 is a rear elevation view of the embodiment of FIG. 7;  
 FIG. 9 is a right elevation view of the embodiment of FIG. 7;  
 FIG. 10 is a top, rear, and right side isometric view of the embodiment of FIG. 7;  
 FIG. 11 is a top, front, and left side isometric view of the embodiment of FIG. 7;  
 FIG. 12 is a top, rear and left perspective view of a second embodiment thereof;  
 FIG. 13 is a top view of one of the embodiments of FIG. 12;  
 FIG. 14 is a rear elevation view of the embodiment of FIG. 13;  
 FIG. 15 is a left elevation view of the embodiment of FIG. 13;  
 FIG. 16 is a top, rear, and left side isometric view of the embodiment of FIG. 13;  
 FIG. 17 is a top, front, and right side isometric view of the embodiment of FIG. 13;  
 FIG. 18 is a top view of the other embodiment of FIG. 12;  
 FIG. 19 is a rear elevation view of the embodiment of FIG. 18;  
 FIG. 20 is a right elevation view of the embodiment of FIG. 18;  
 FIG. 21 is a top, rear, and right side isometric view of the embodiment of FIG. 18;  
 FIG. 22 is a top, front, and left side isometric view of the embodiment of FIG. 18;  
 FIG. 23 is a top, rear and left perspective view of a third embodiment thereof;  
 FIG. 24 is a top view of one of the embodiments of FIG. 23;  
 FIG. 25 is a rear elevation view of the embodiment of FIG. 24;  
 FIG. 26 is a left elevation view of the embodiment of FIG. 24;  
 FIG. 27 is a top, rear, and left side isometric view of the embodiment of FIG. 24;  
 FIG. 28 is a top, front, and right side isometric view of the embodiment of FIG. 24;  
 FIG. 29 is a top view of the other embodiment of FIG. 23;  
 FIG. 30 is a rear elevation view of the embodiment of FIG. 29;  
 FIG. 31 is a right elevation view of the embodiment of FIG. 29;

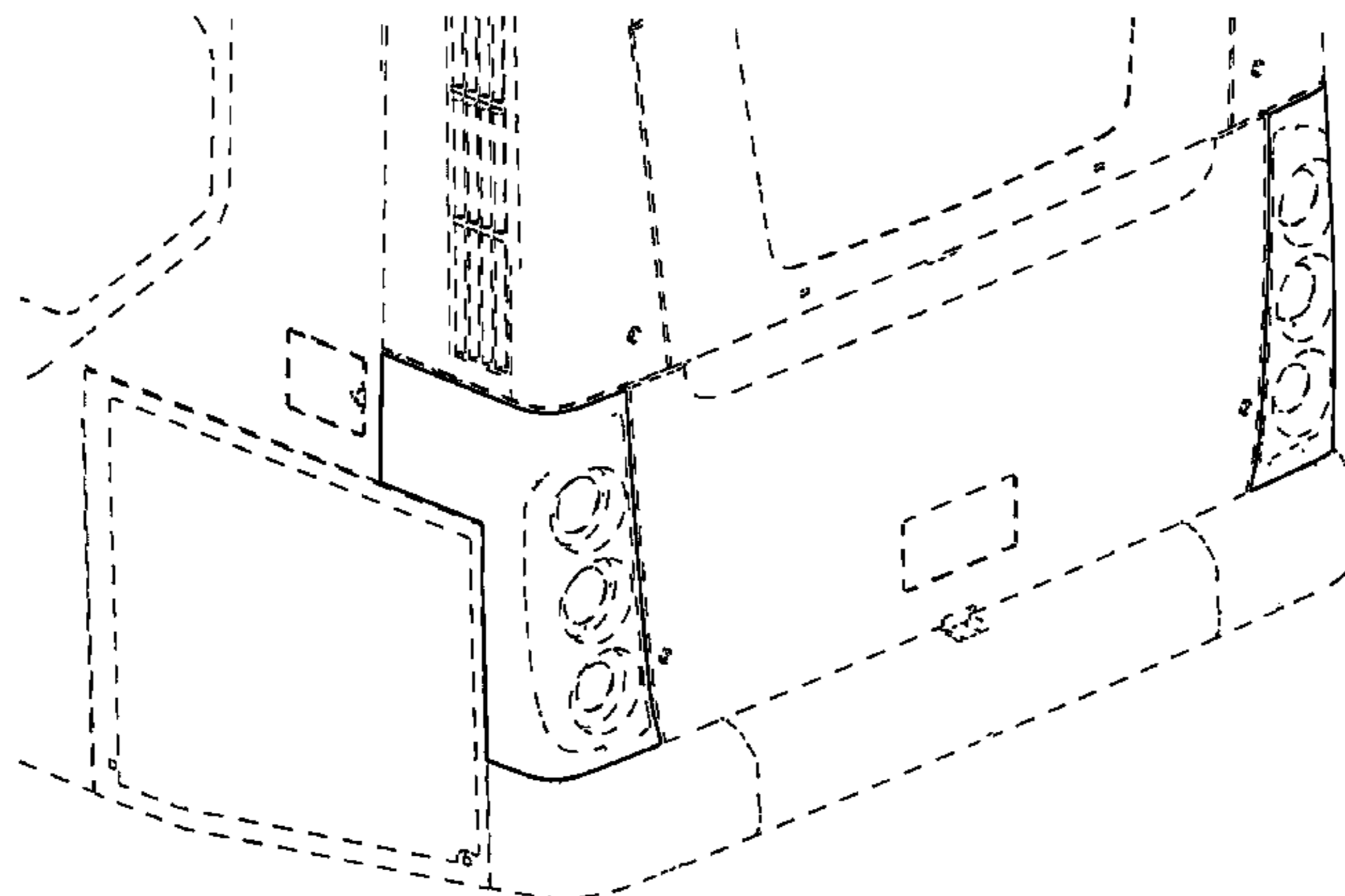

FIG. 32 is a top, rear, and right side isometric view of the embodiment of FIG. 29; and,  
FIG. 33 is a top, front, and left side isometric view of the embodiment of FIG. 29.

The environmental structures shown in broken lines throughout the drawings are for illustrative purposes only and form no part of the claimed design.

**1 Claim, 9 Drawing Sheets**

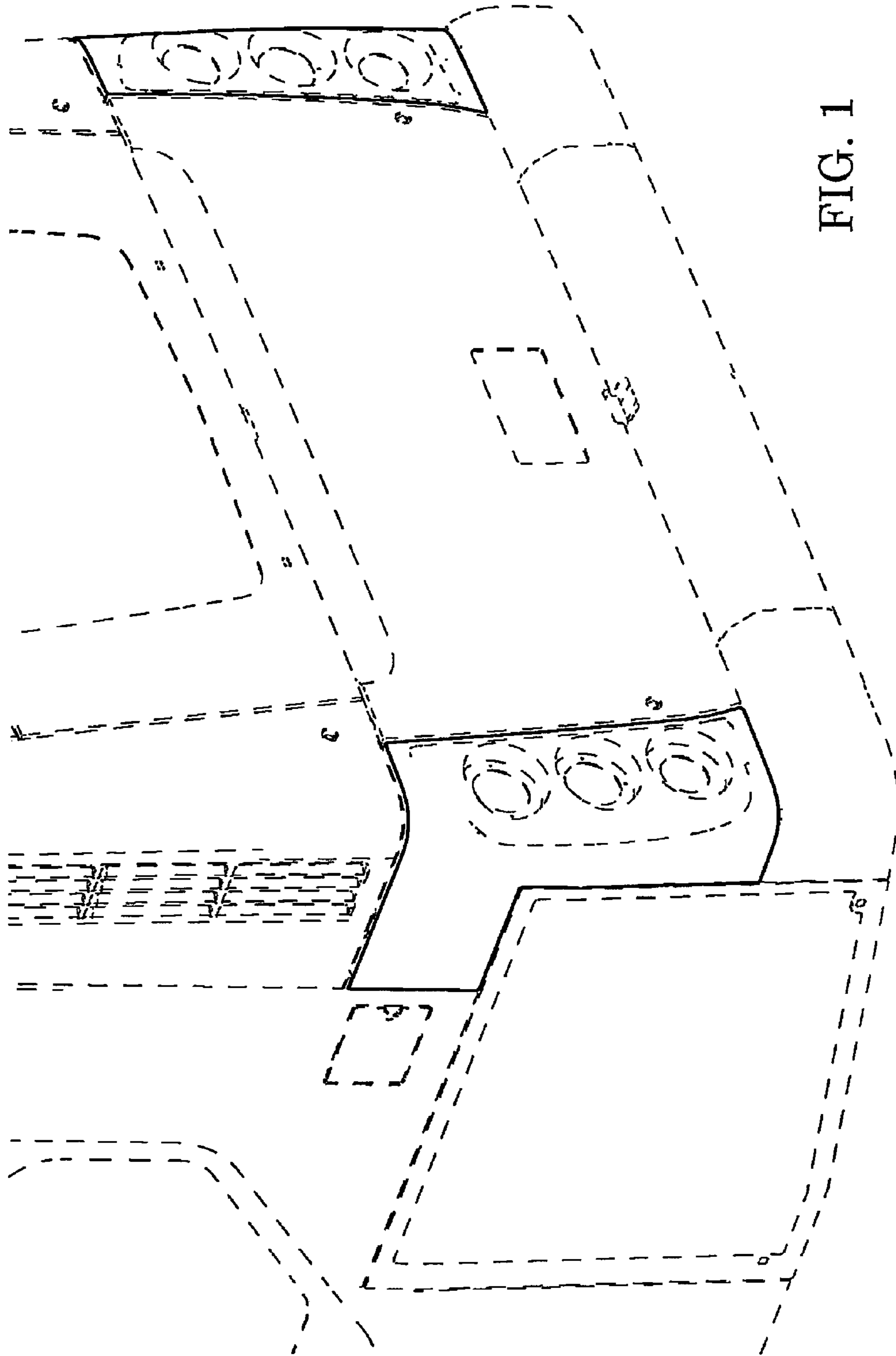

FIG. 1

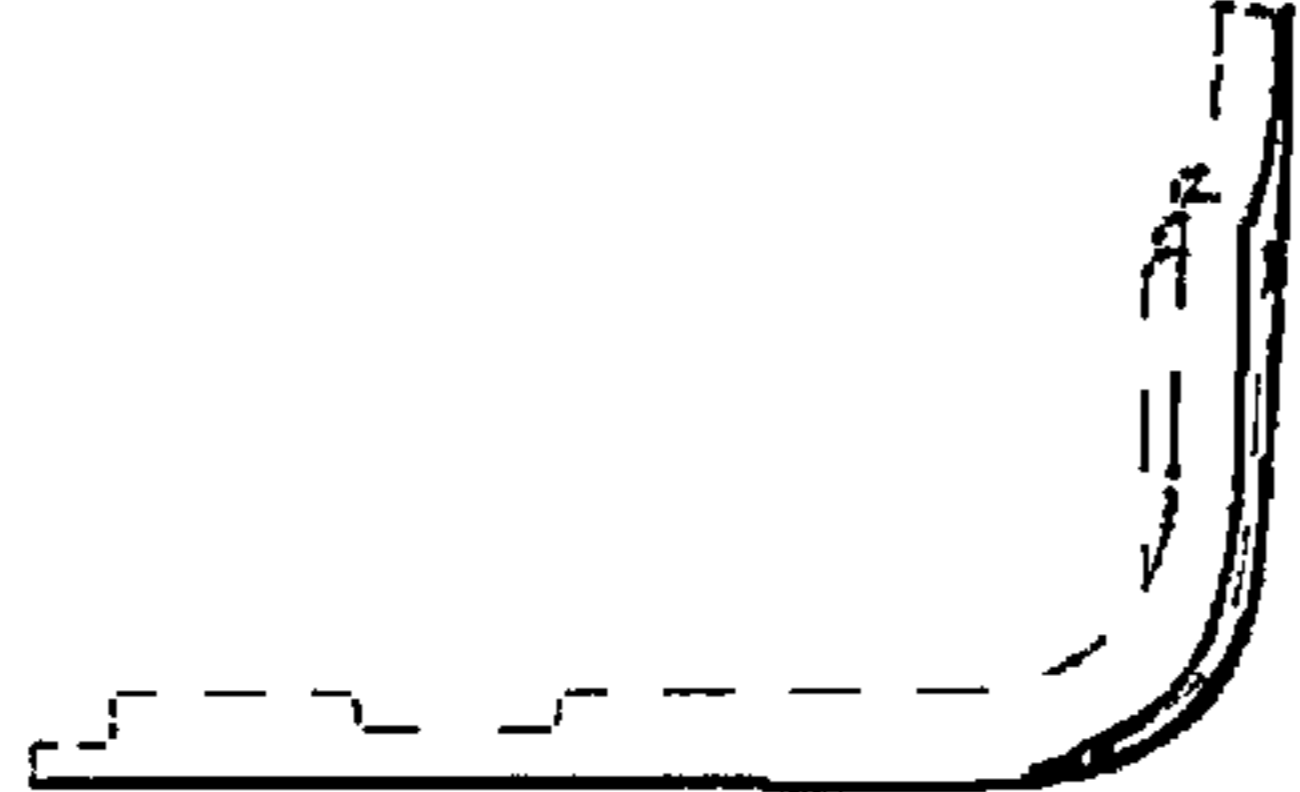

FIG. 2

FIG. 3

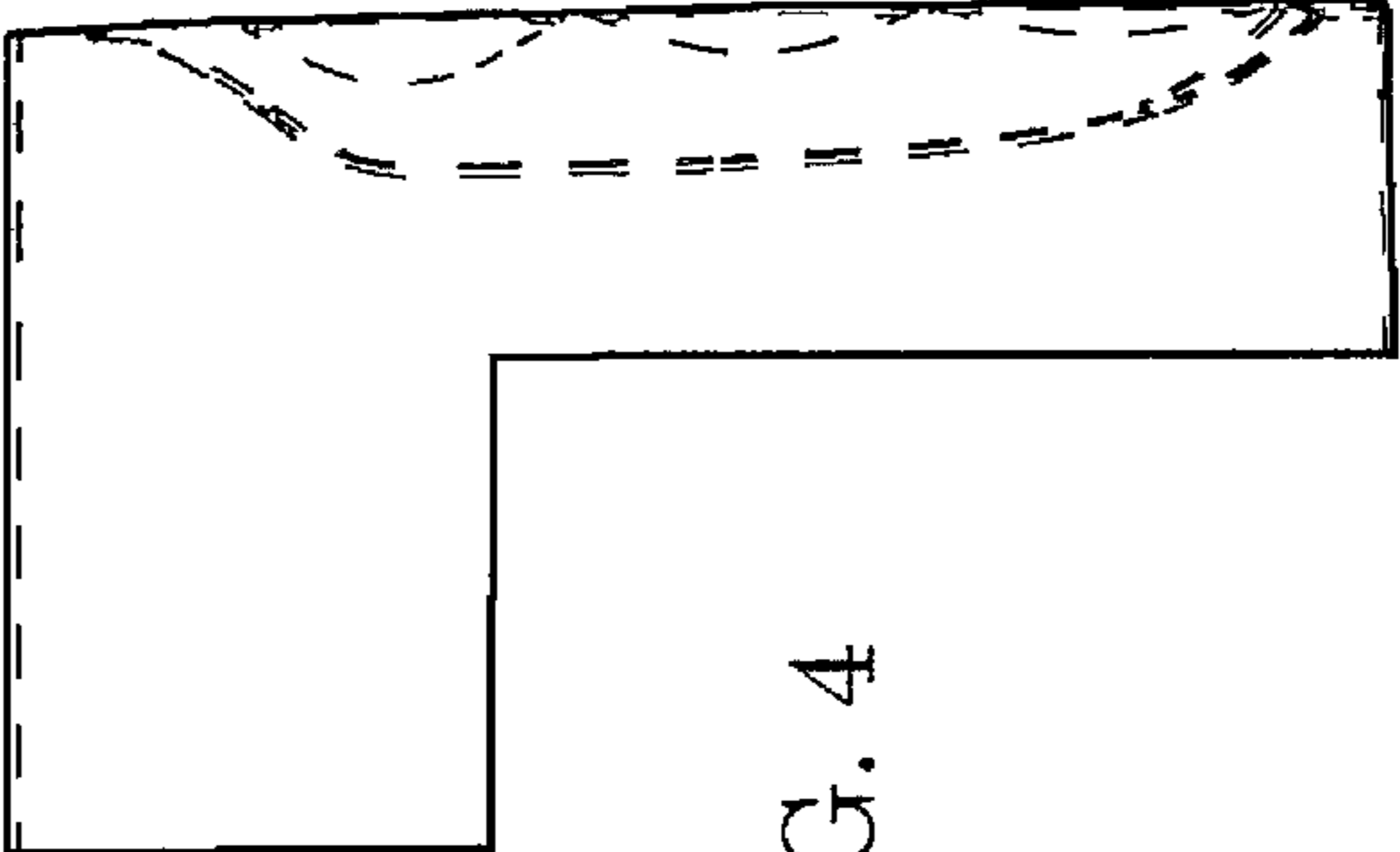
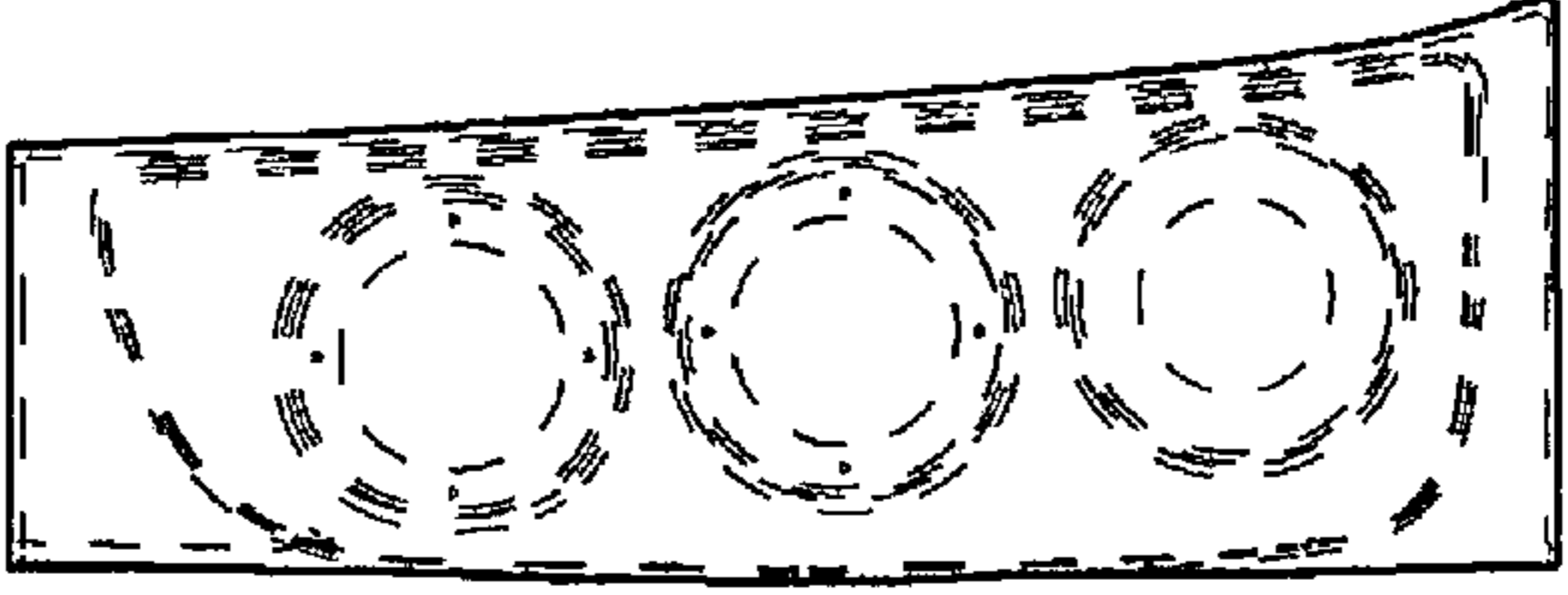

FIG. 4

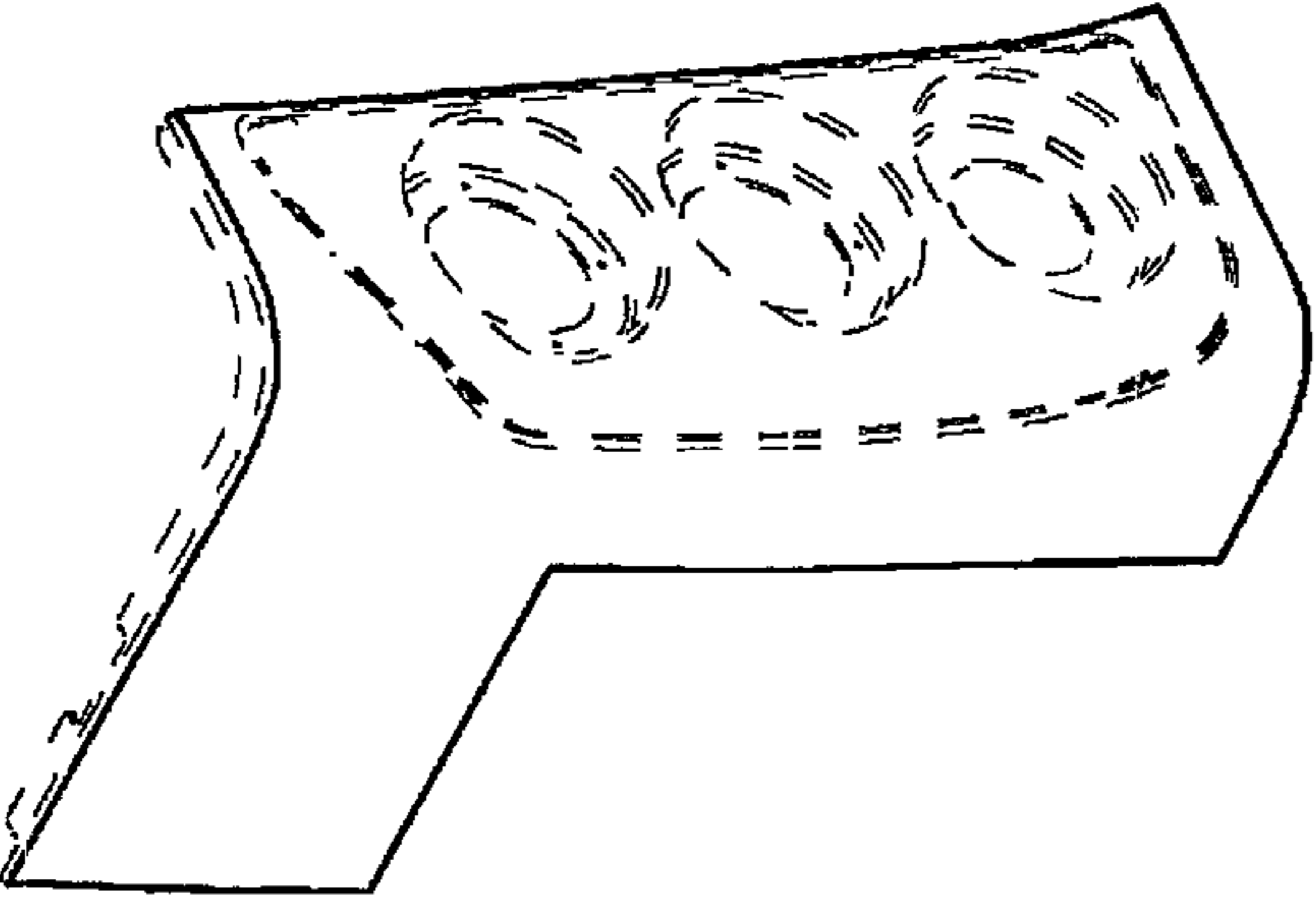
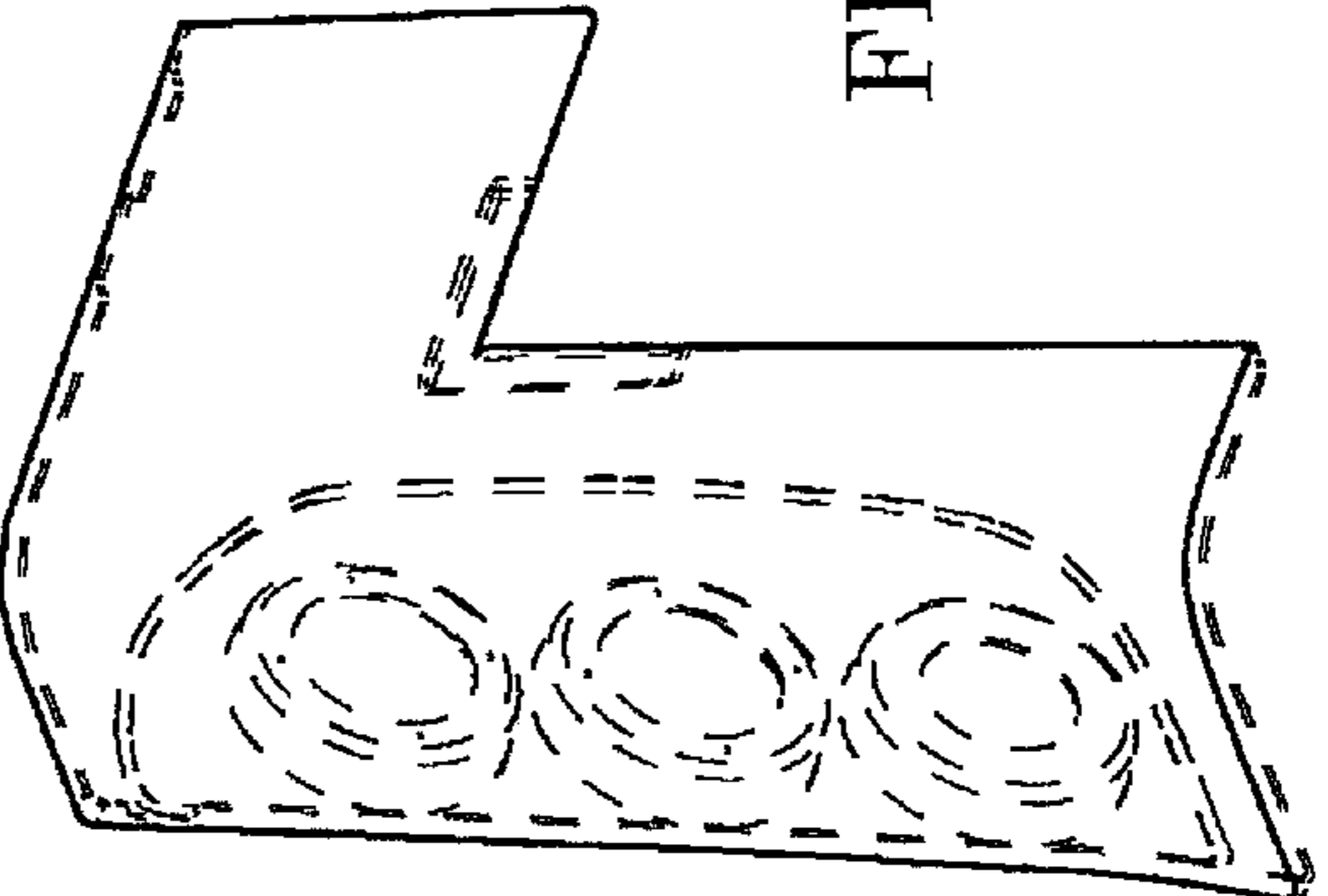

FIG. 5

FIG. 6



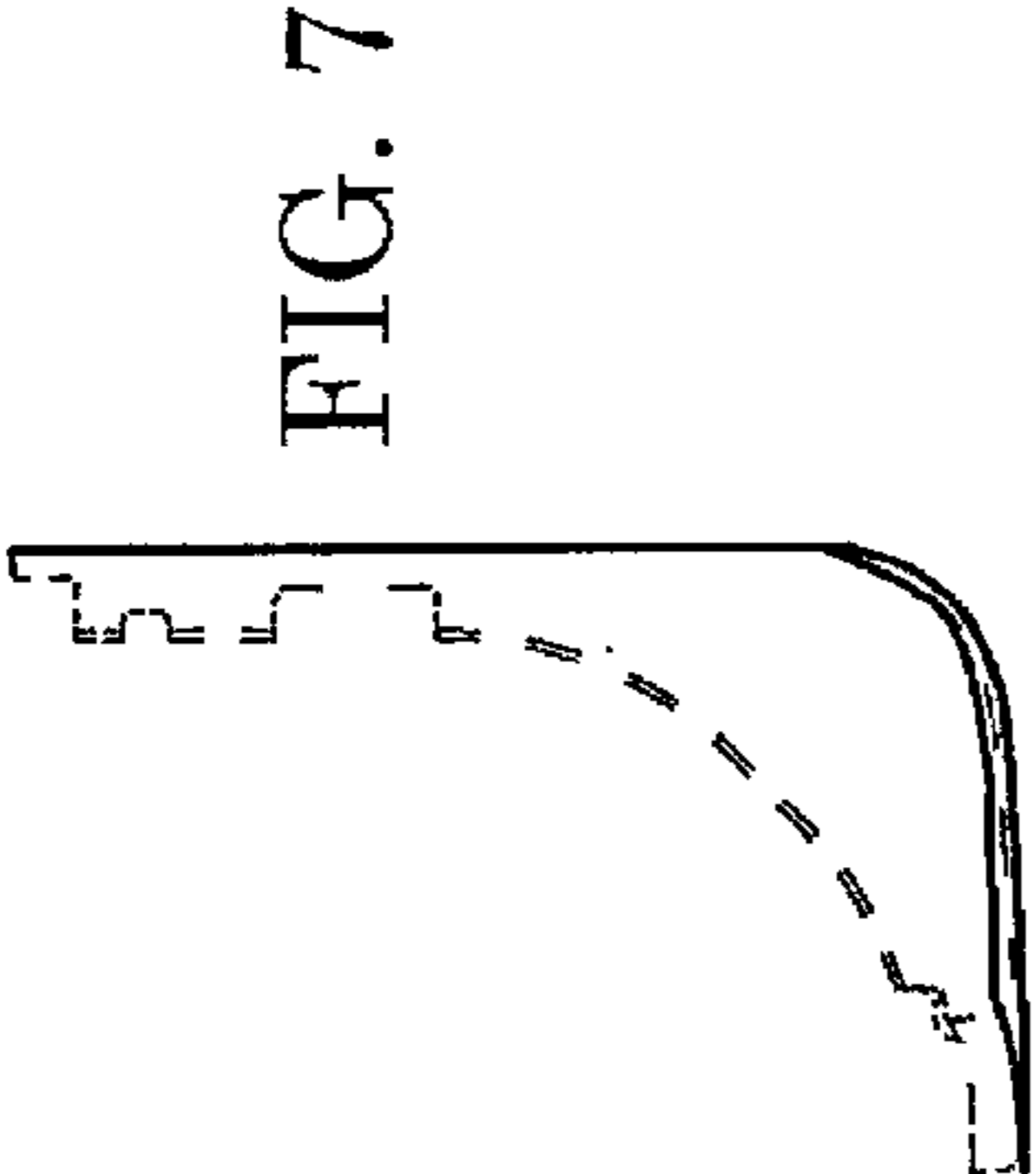

FIG. 8

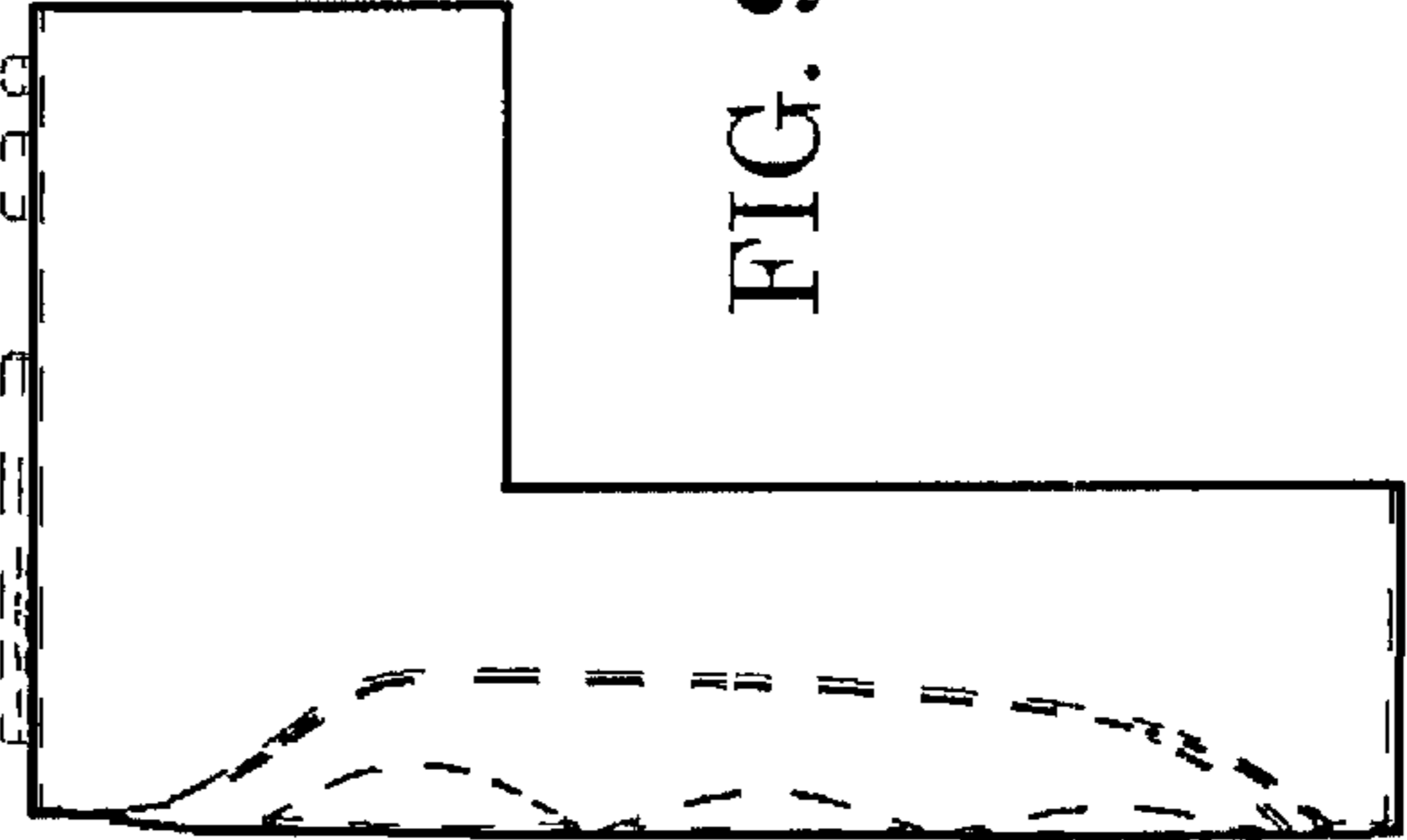
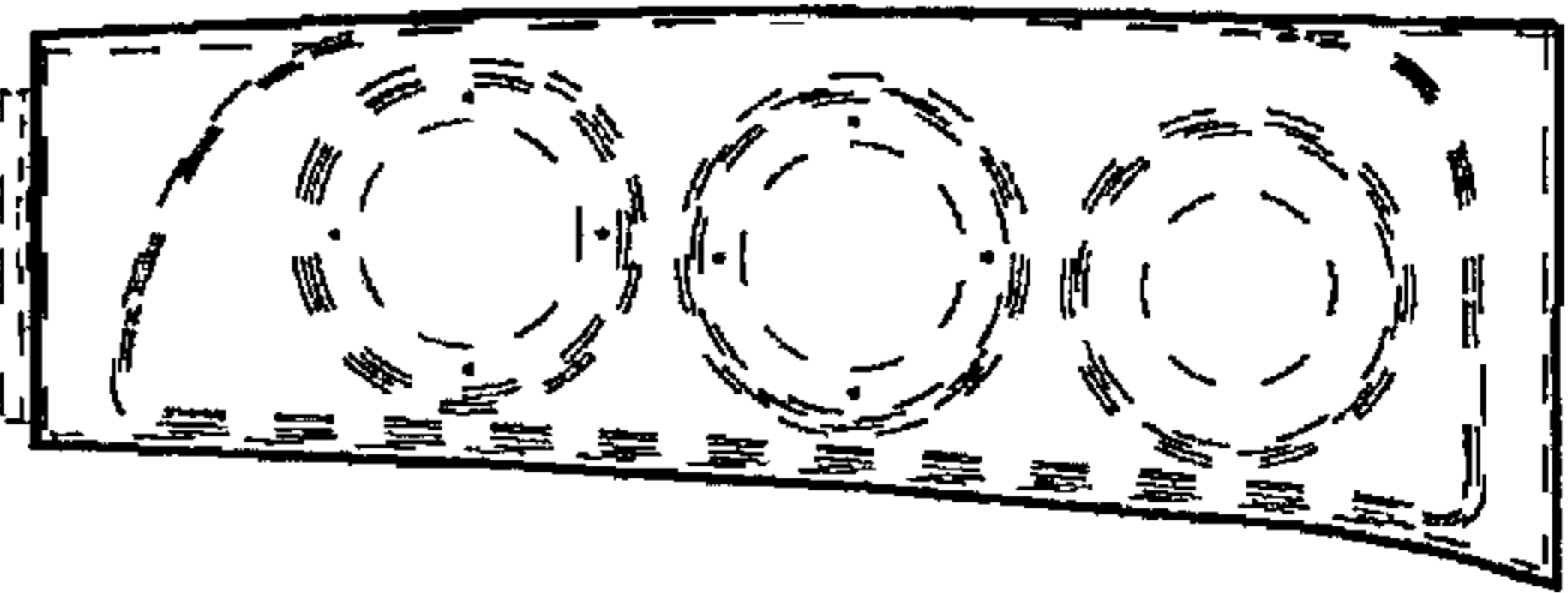

FIG. 9

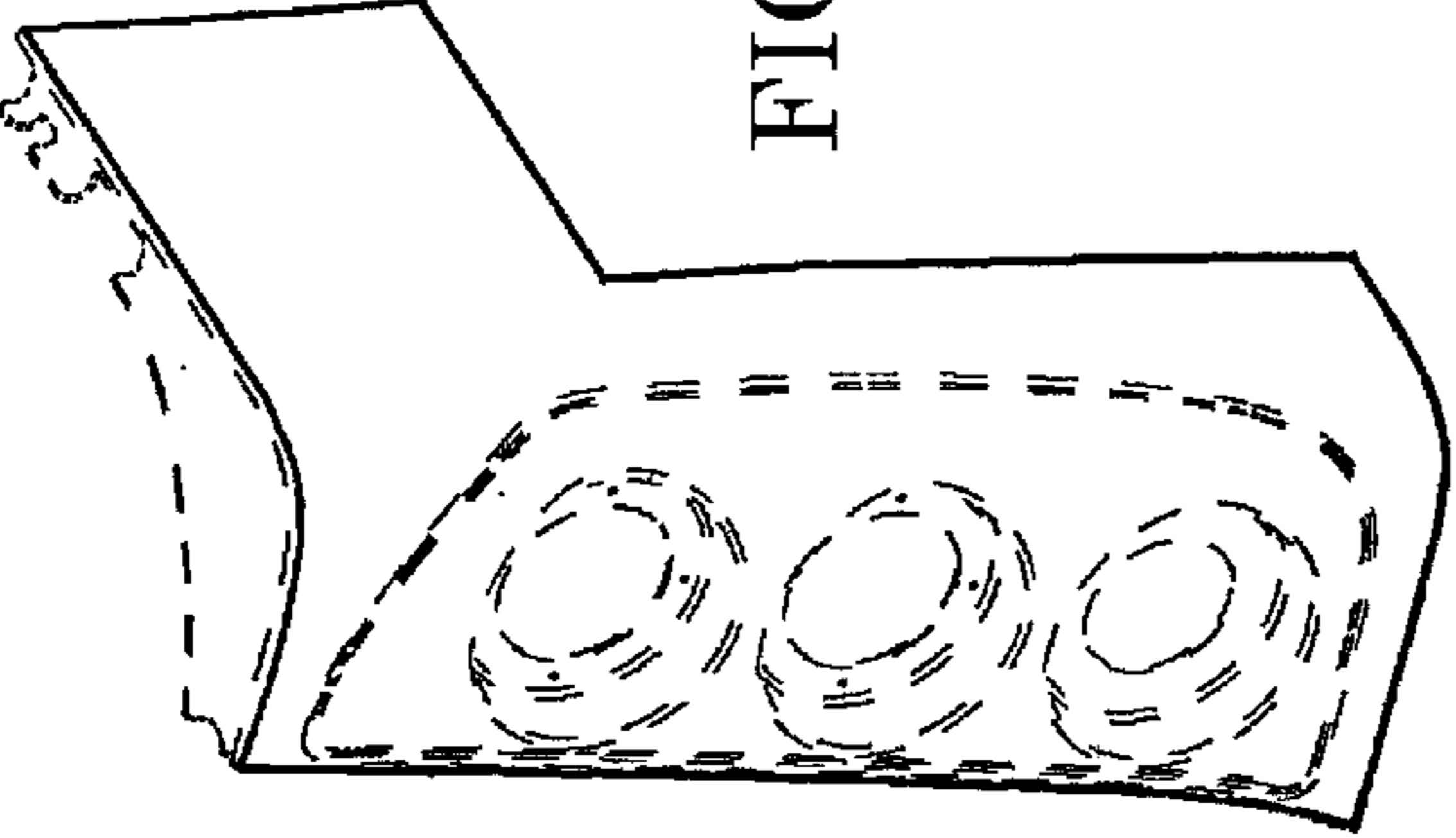

FIG. 10

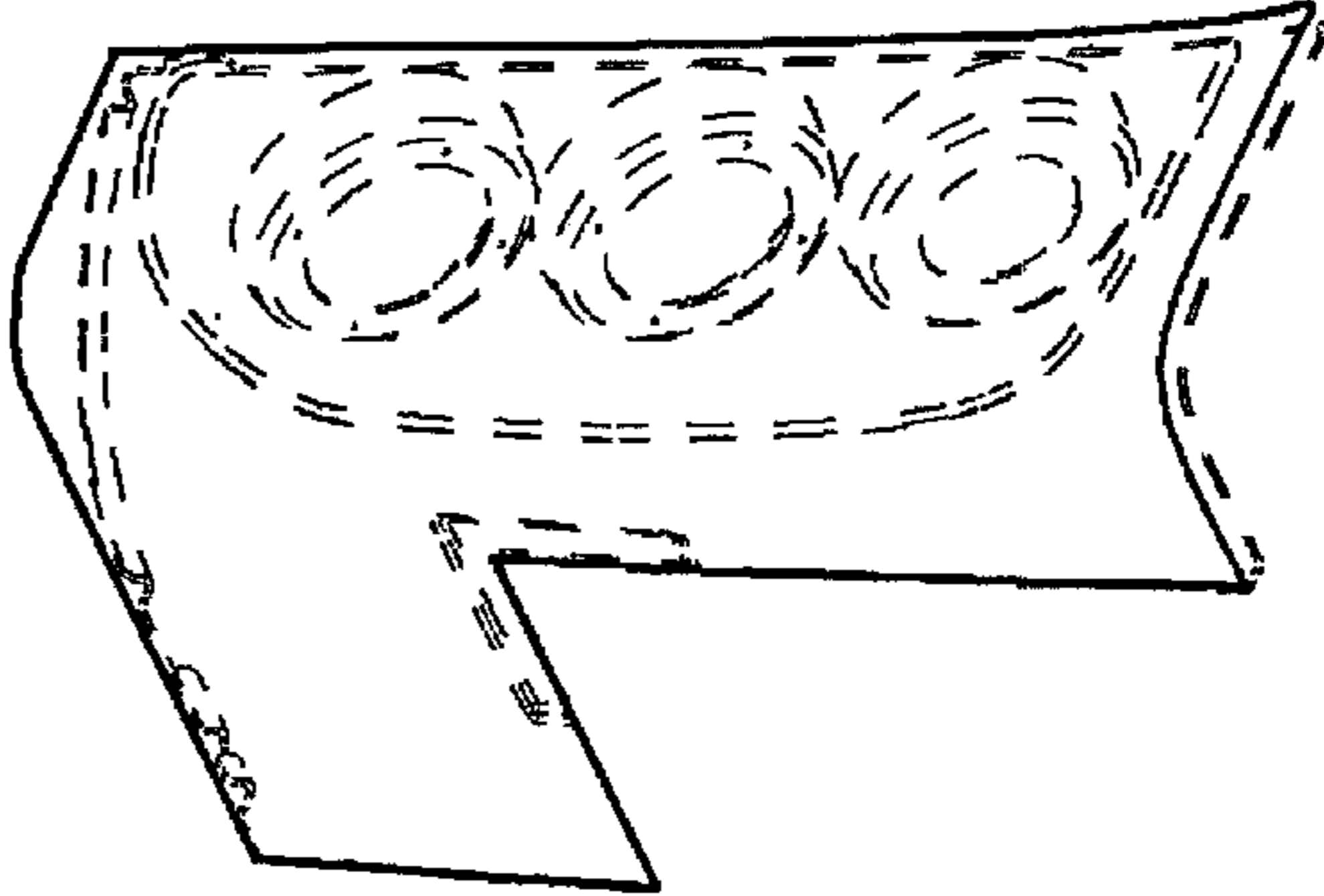

FIG. 11



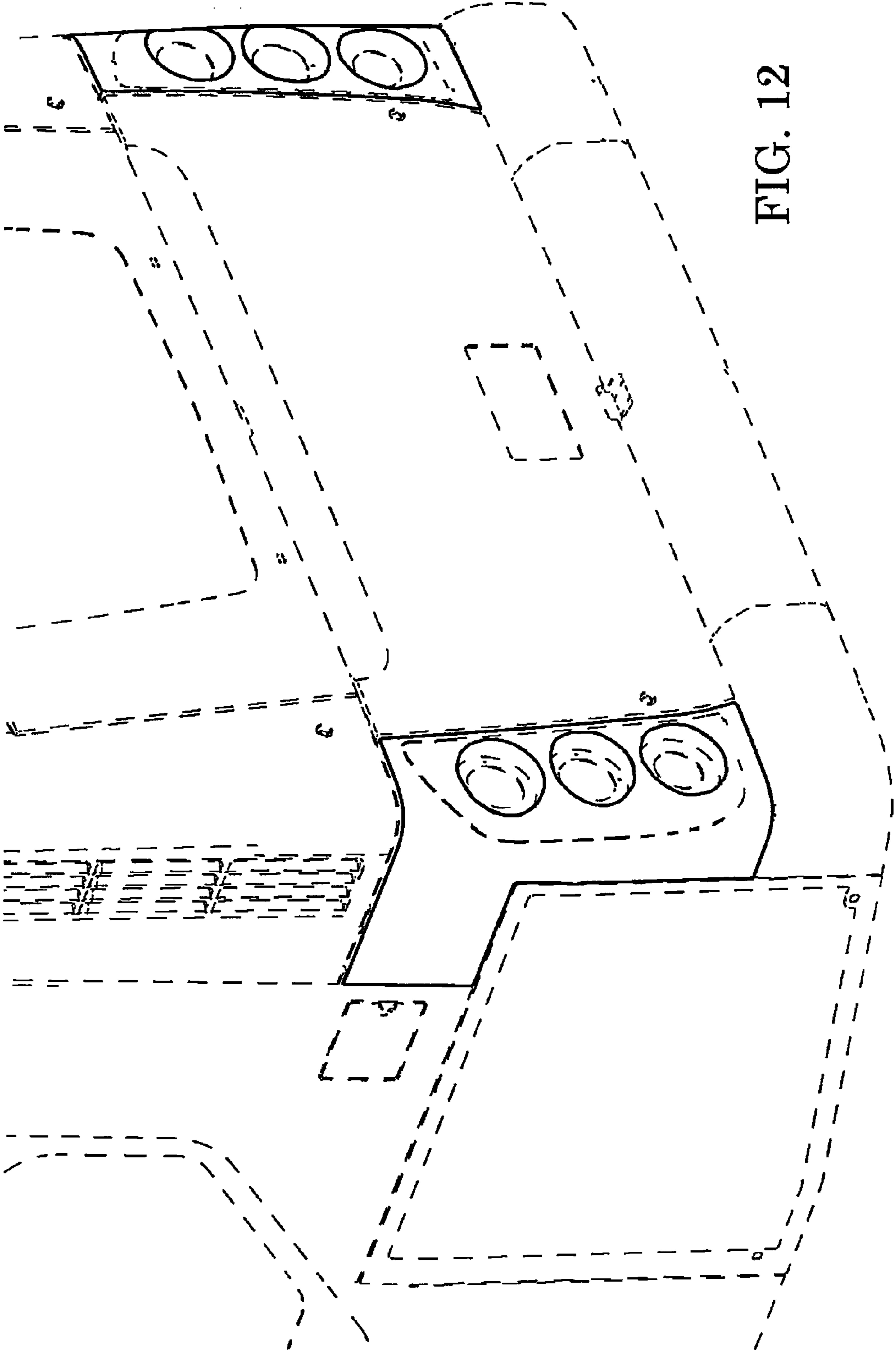

FIG. 12

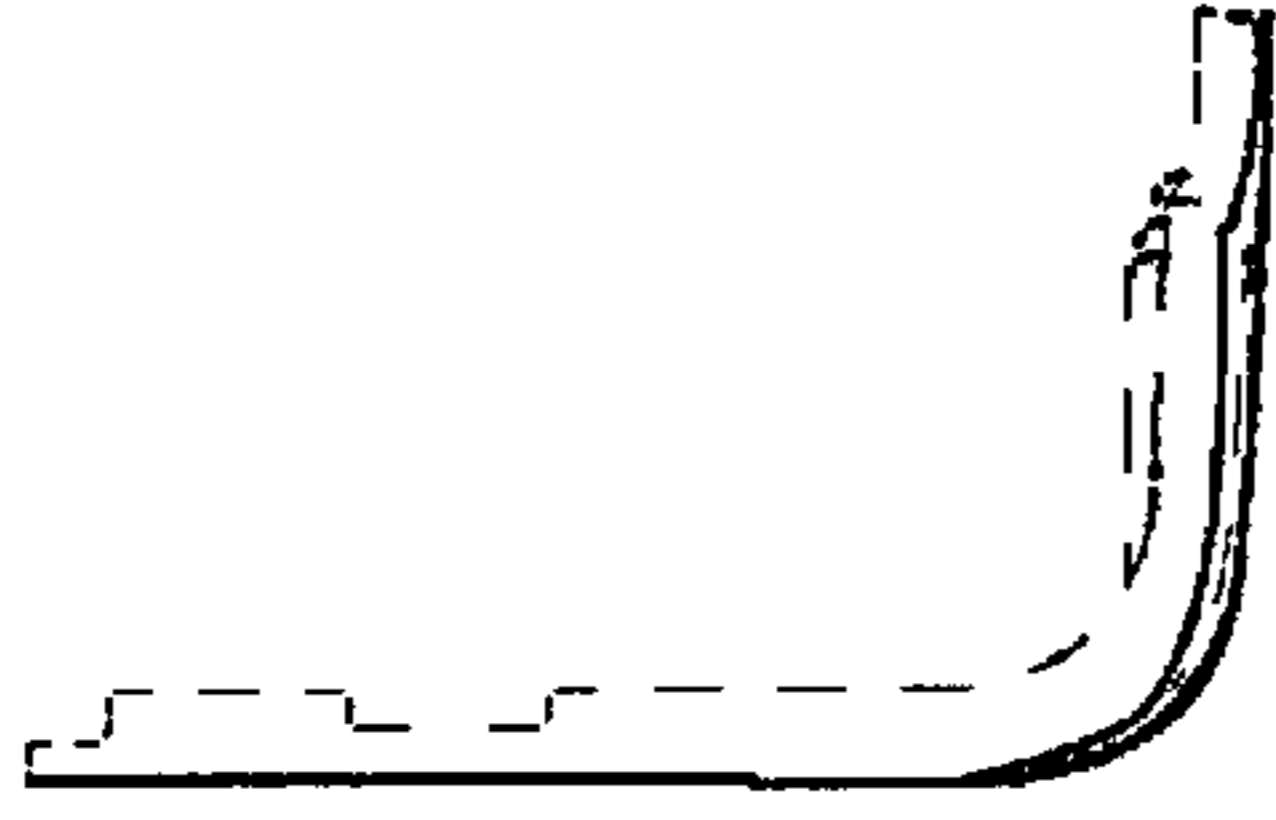

FIG. 13

FIG. 14

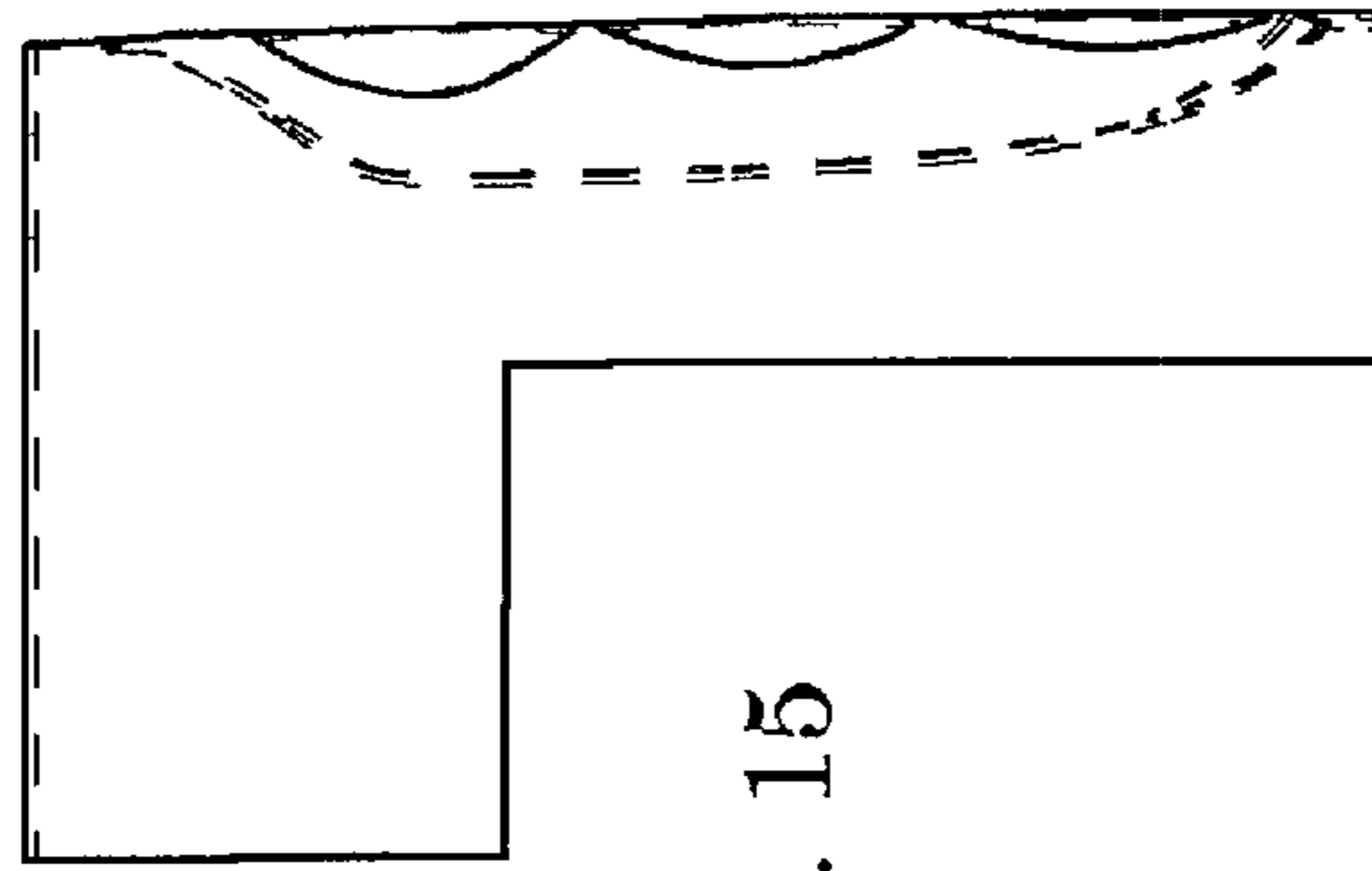
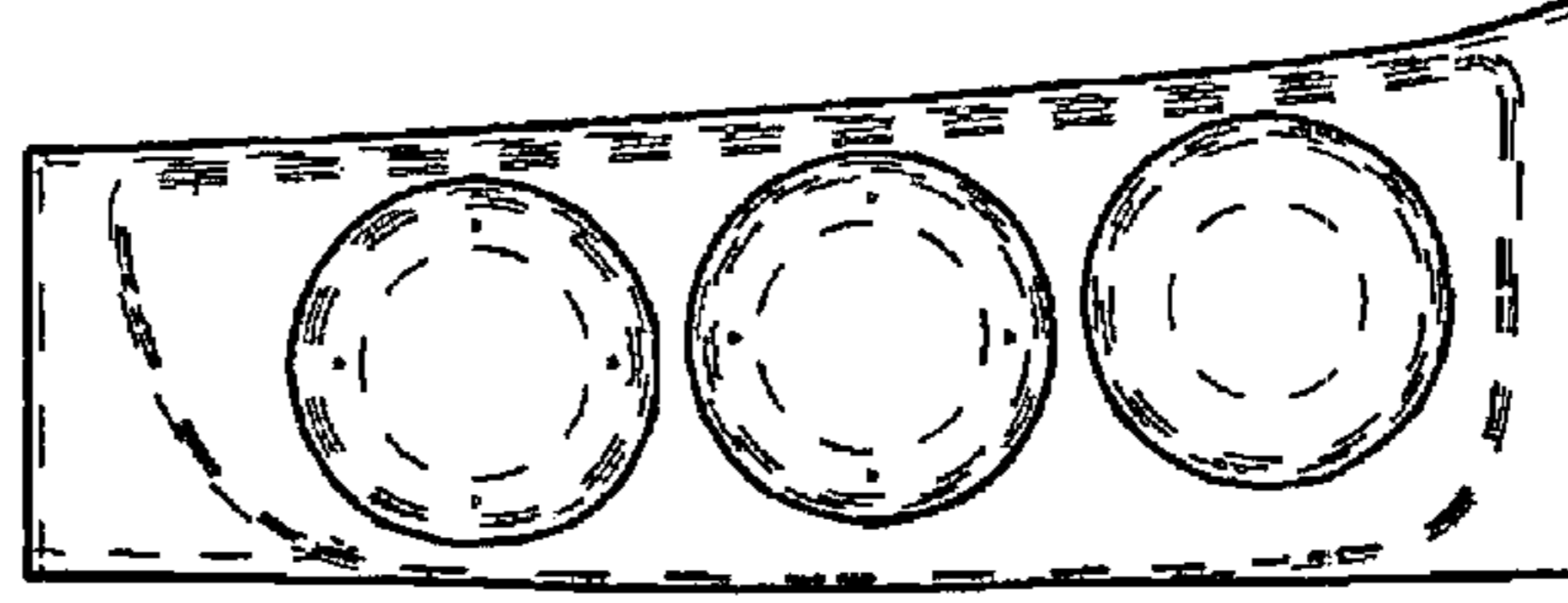

FIG. 15

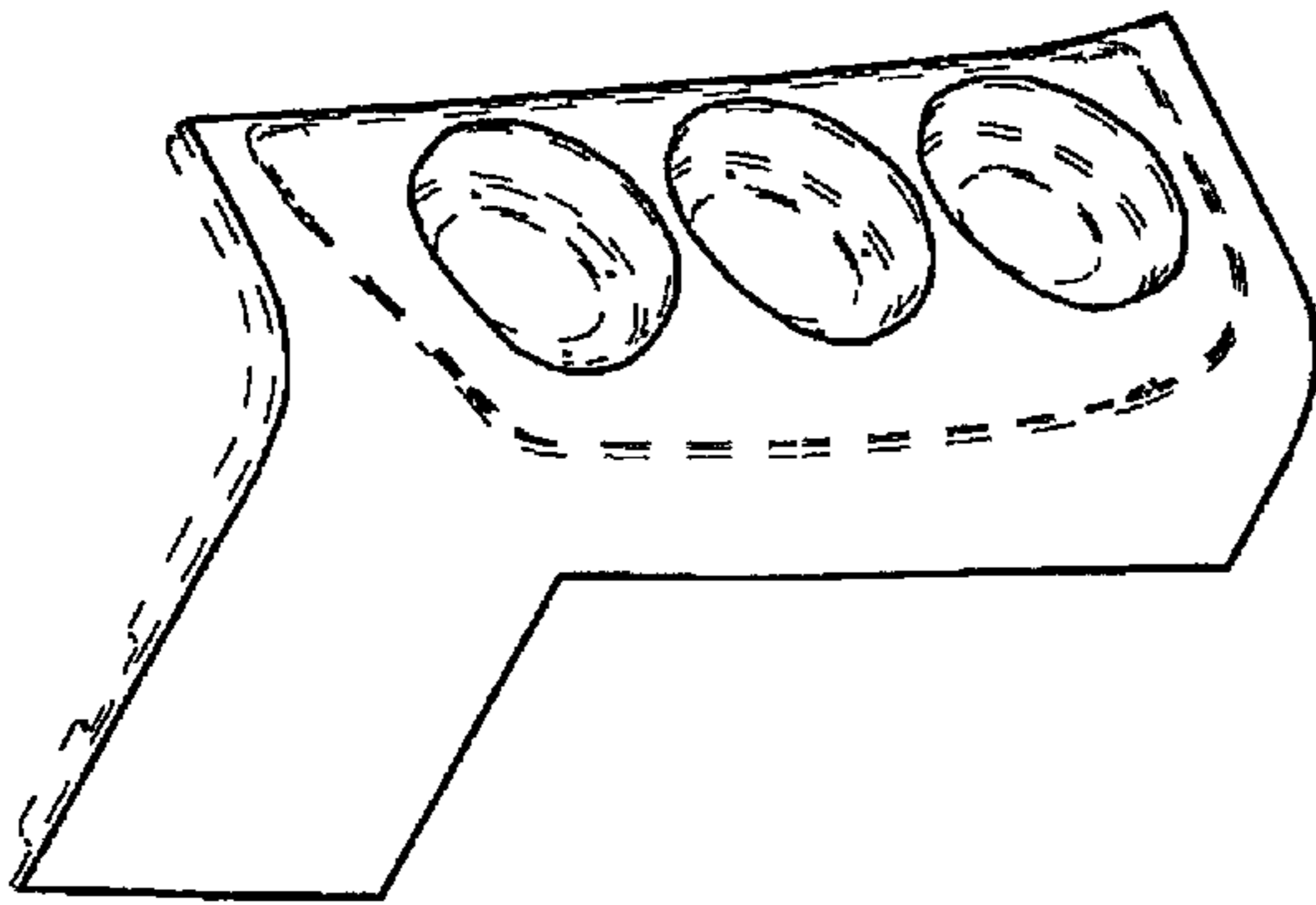
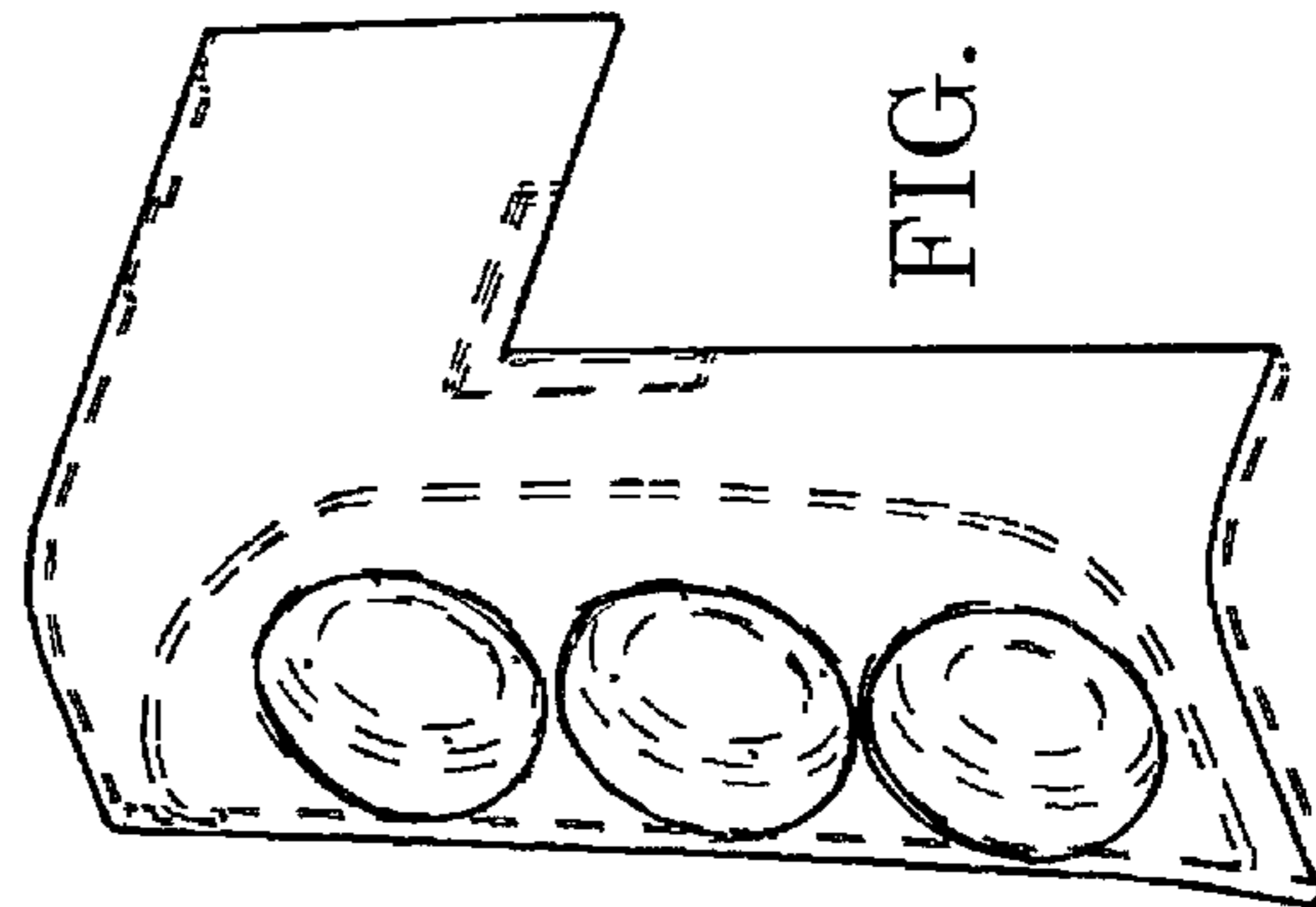

FIG. 16

FIG. 17



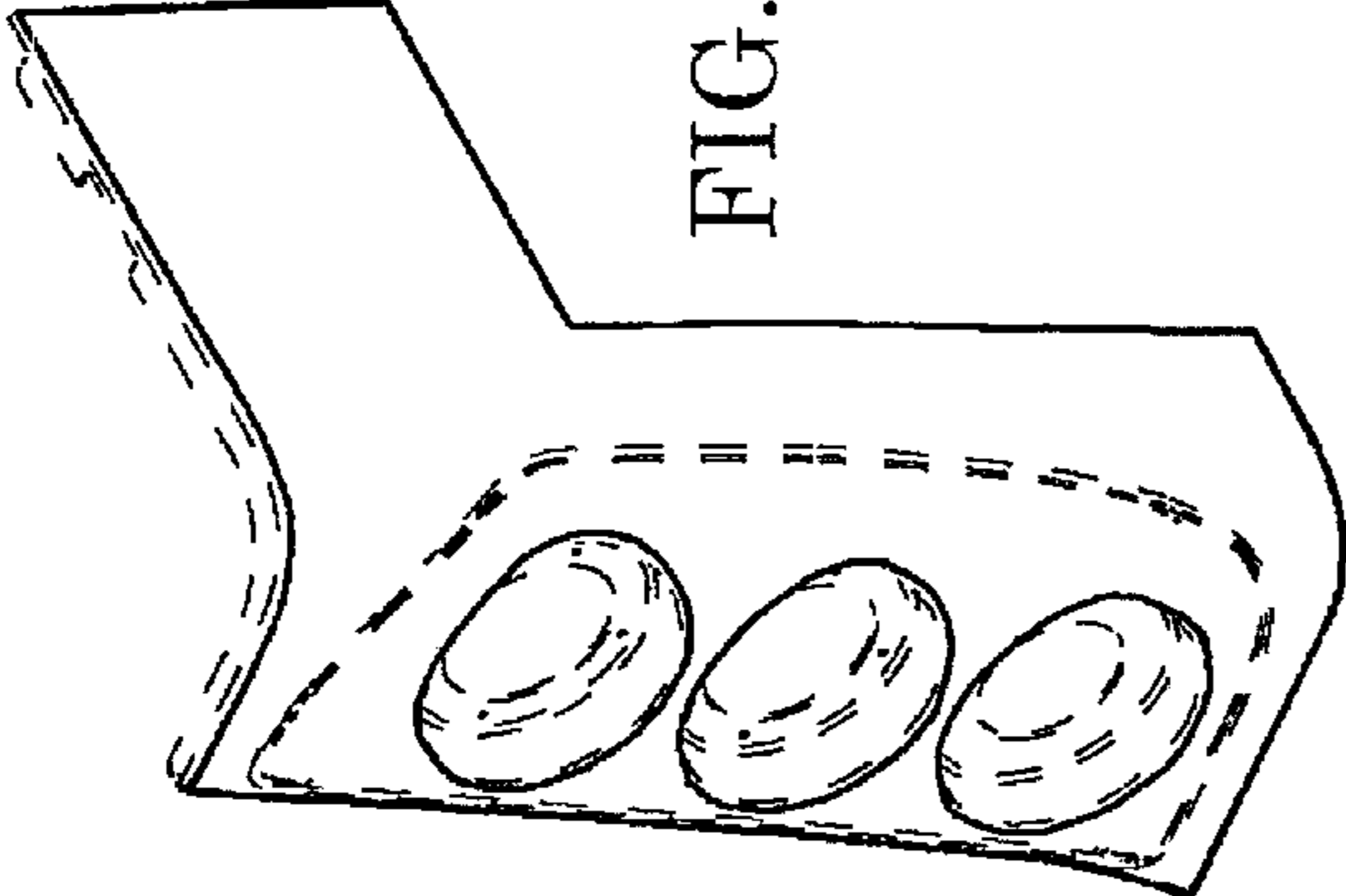

FIG. 21

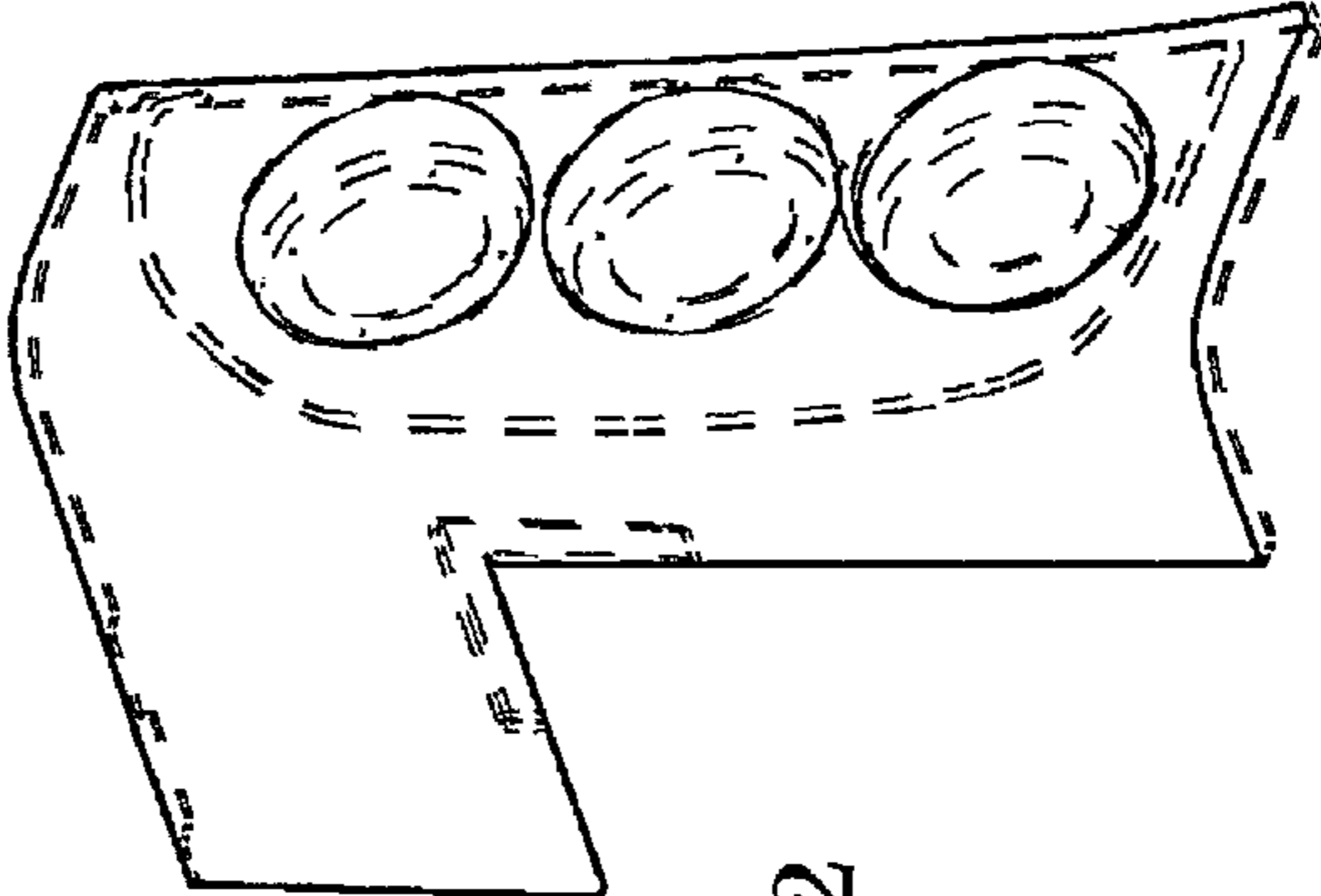

FIG. 22

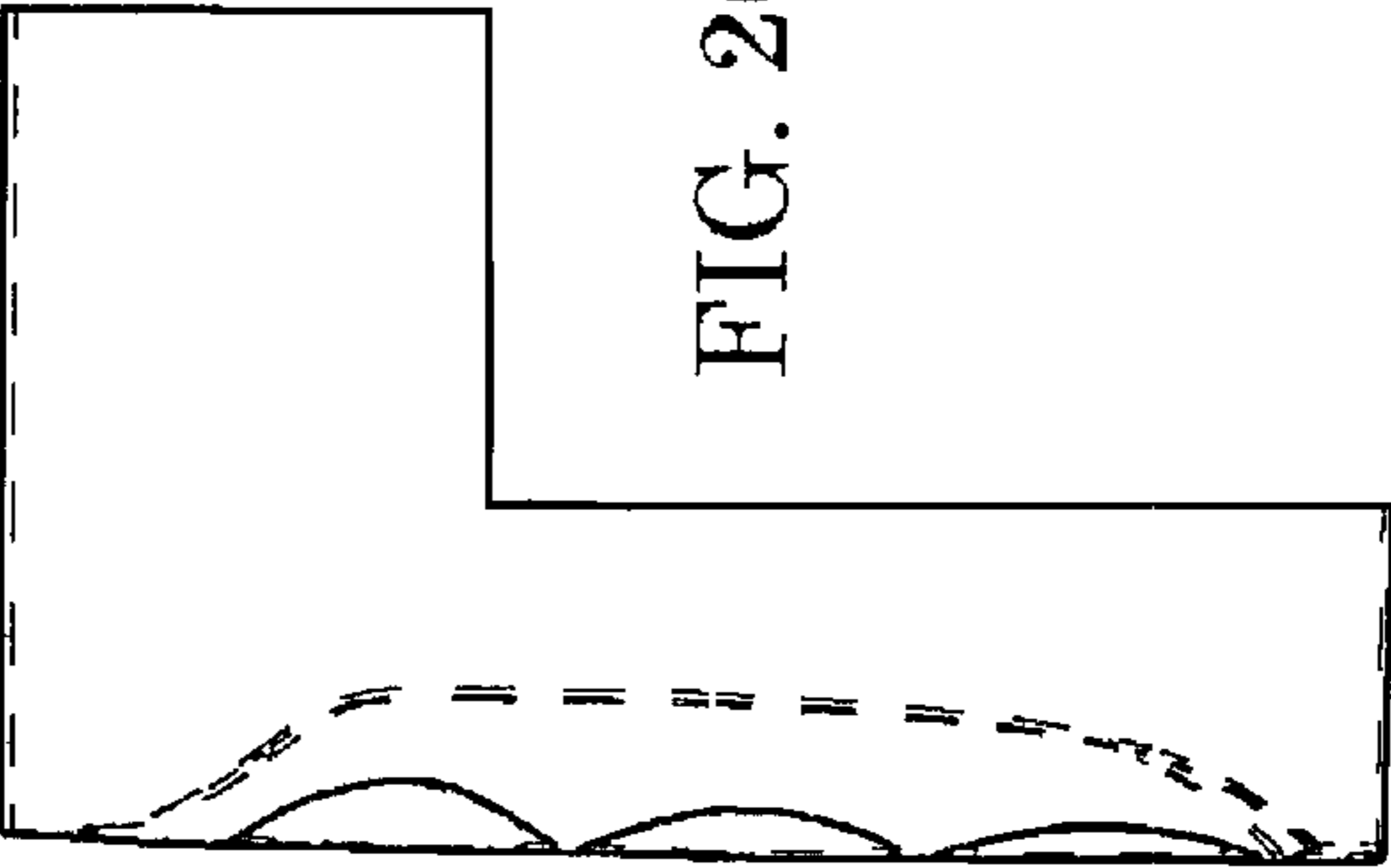

FIG. 20

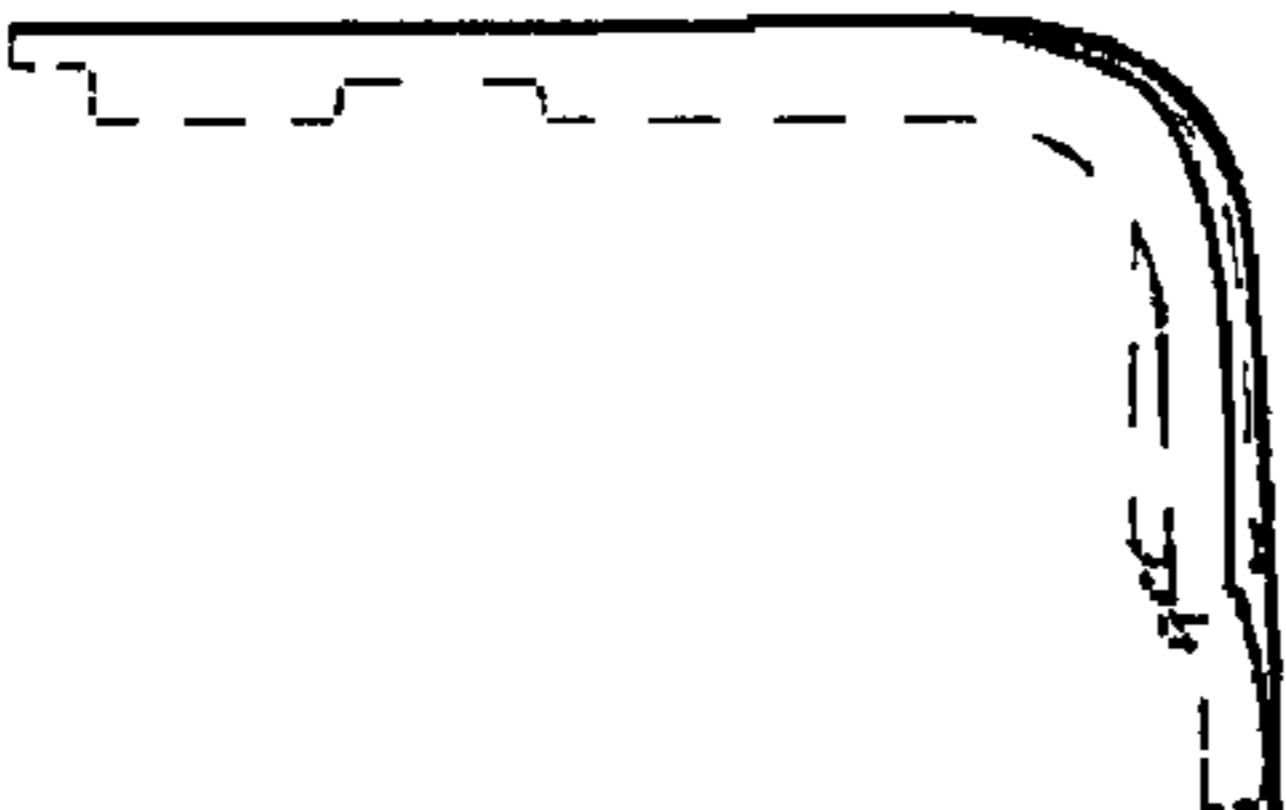
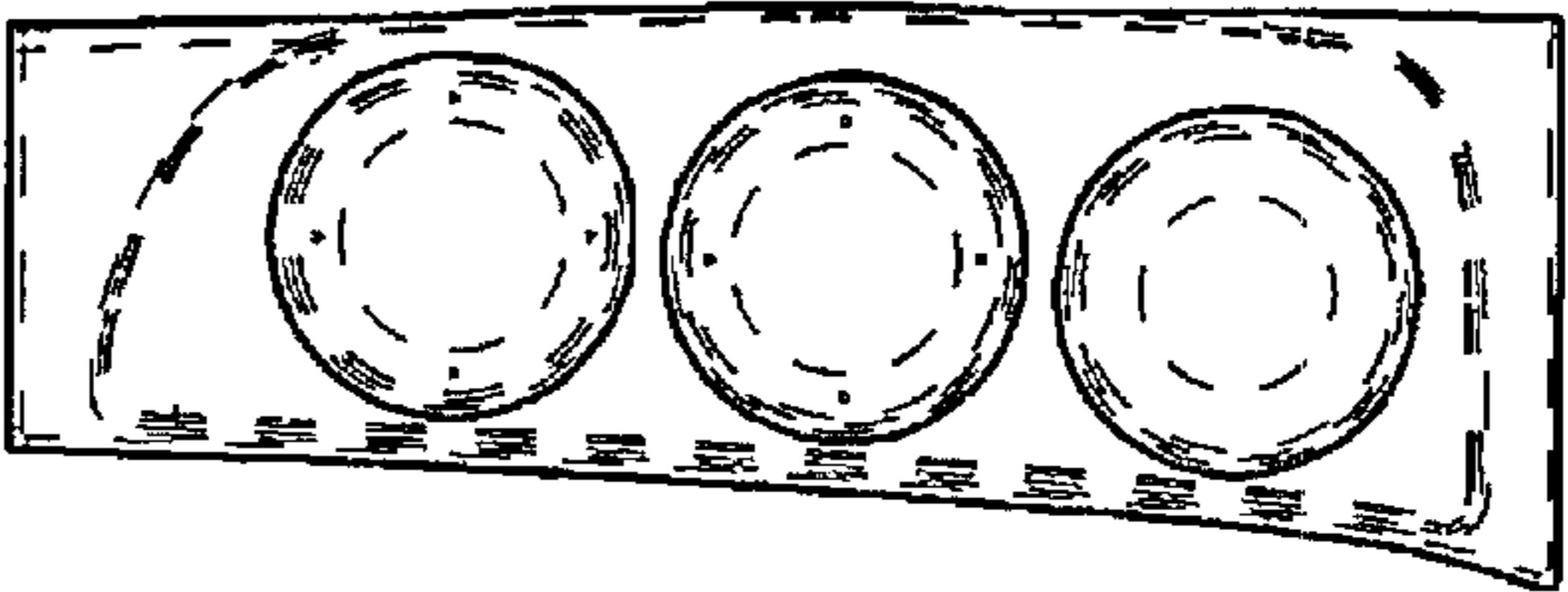

FIG. 18

FIG. 19





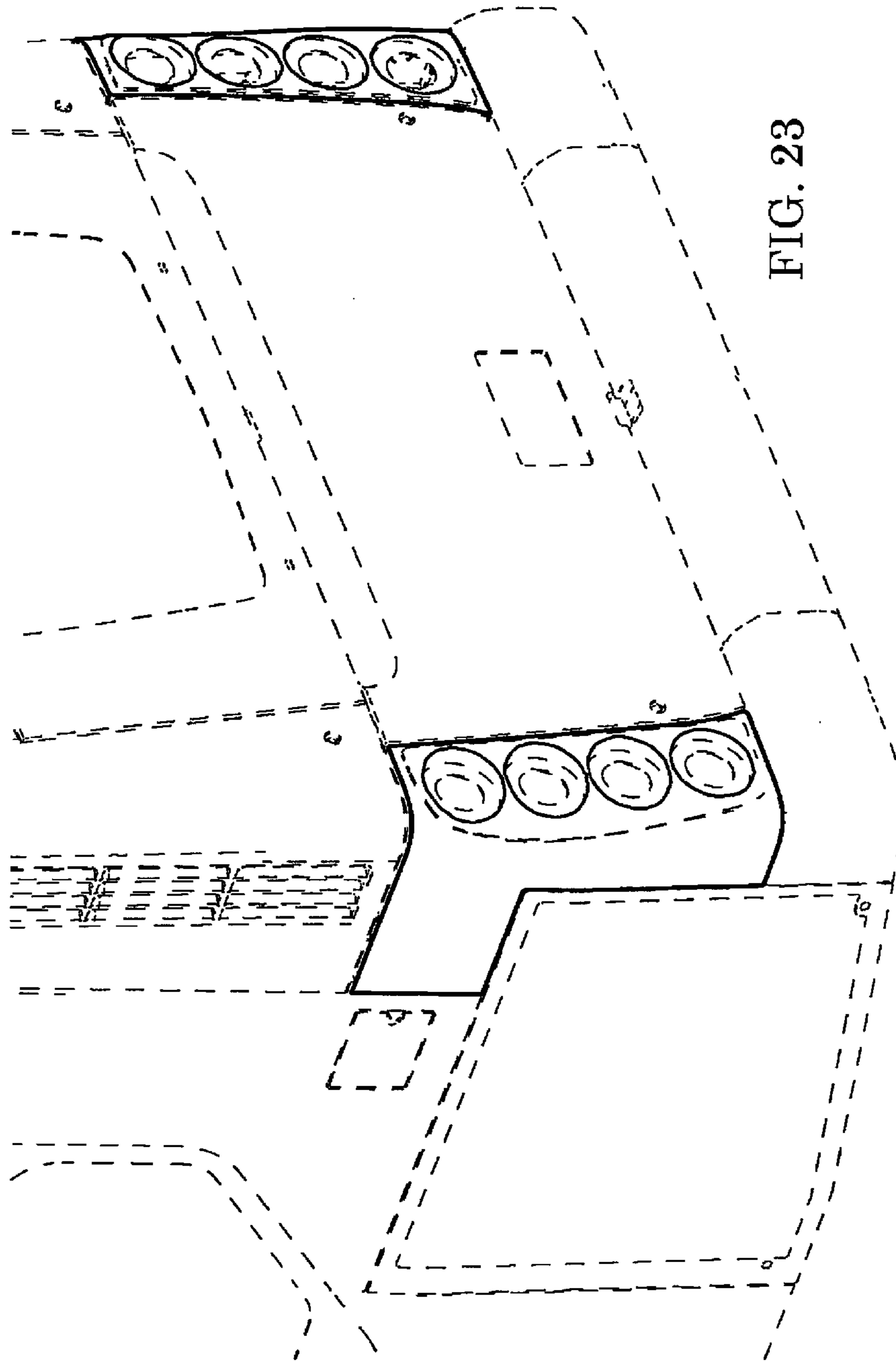

FIG. 23

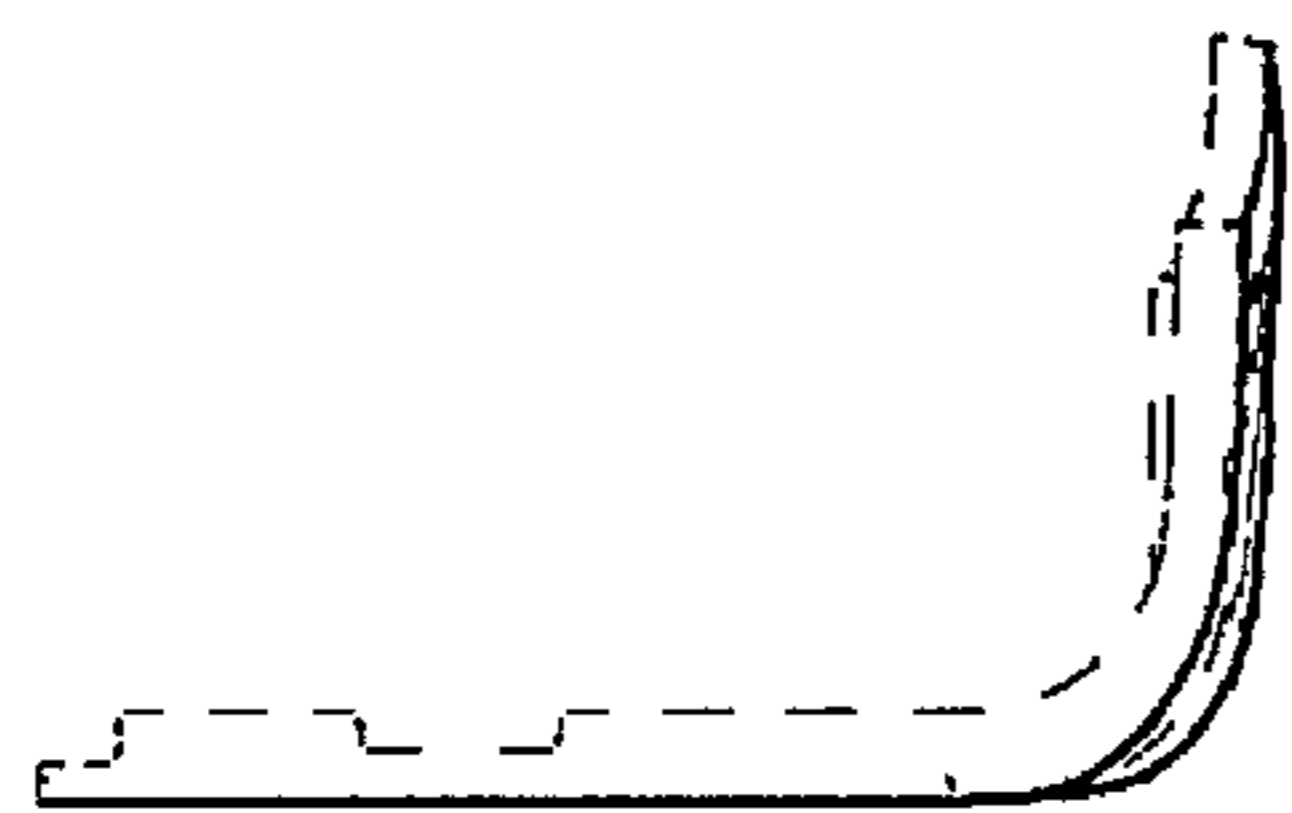

FIG. 24

FIG. 25

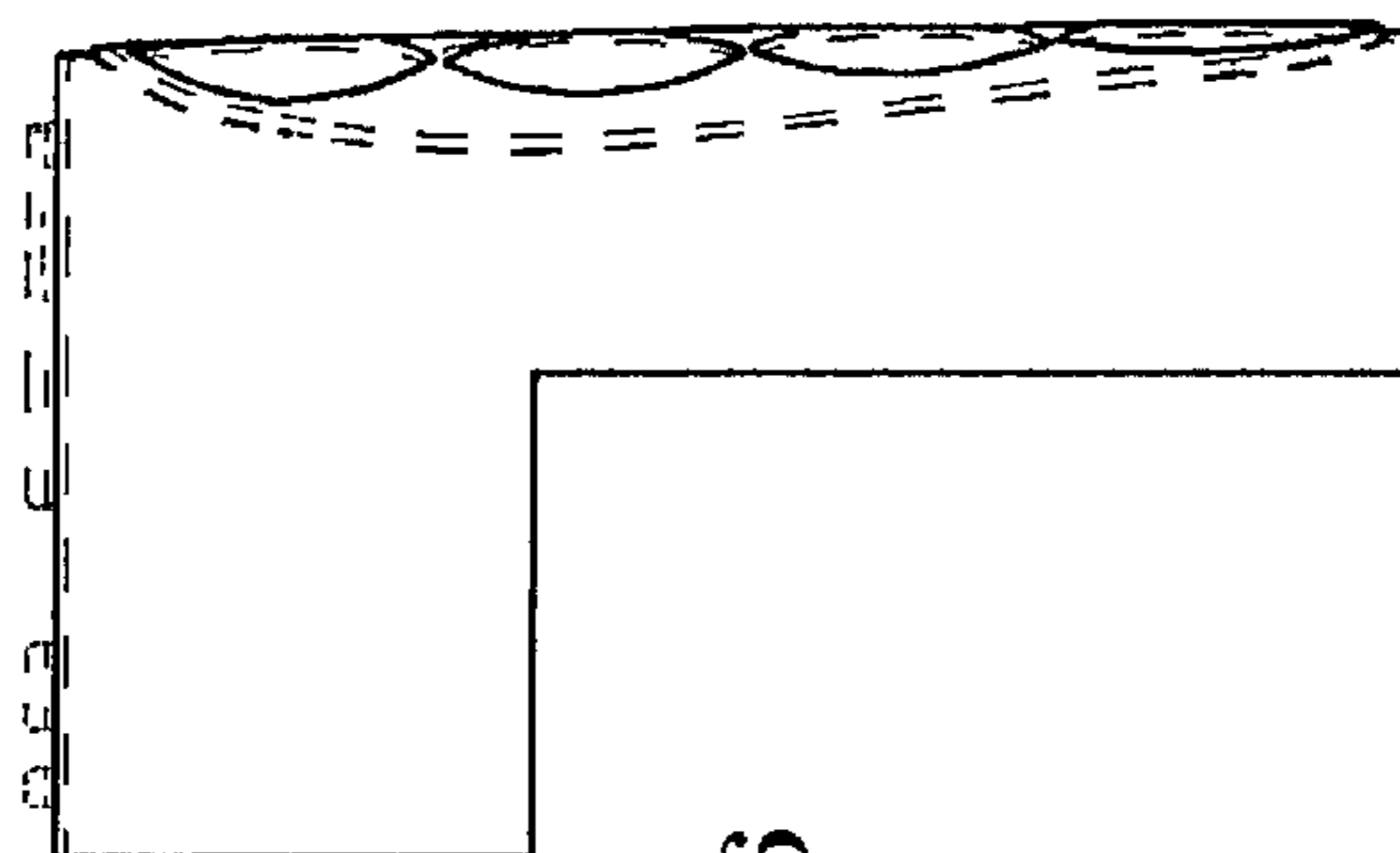
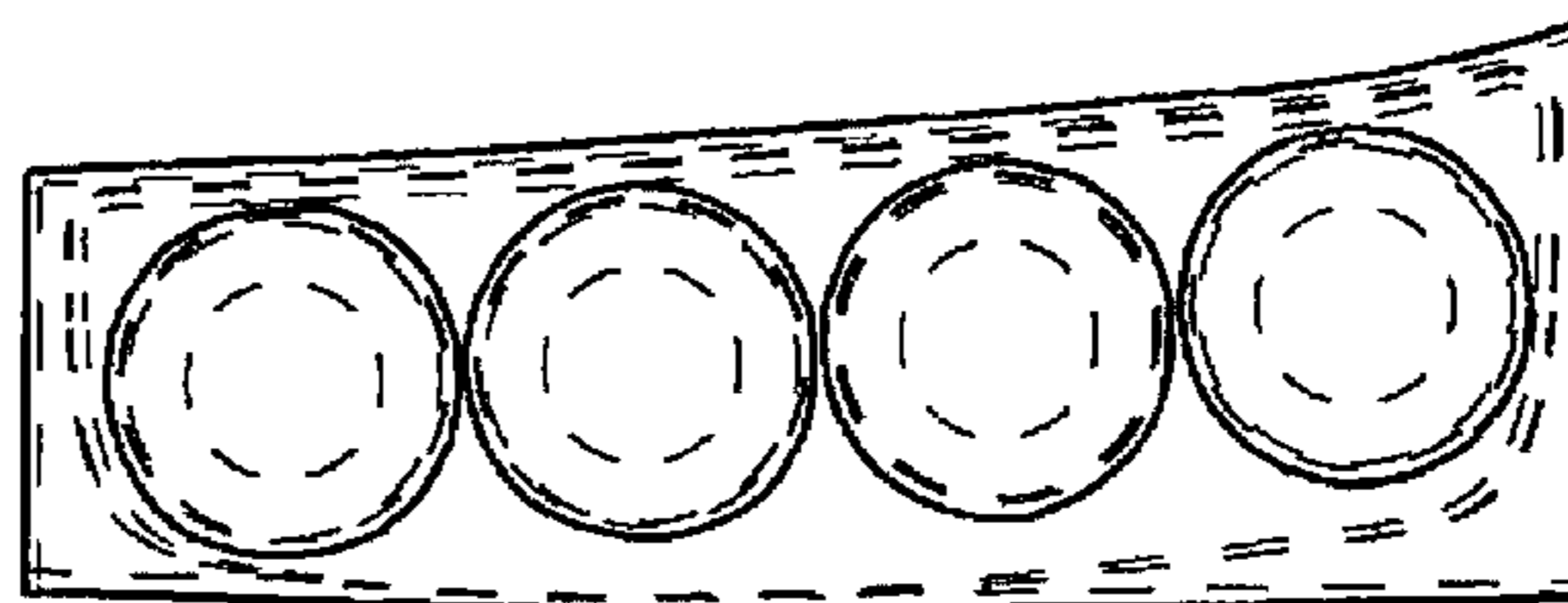

FIG. 26

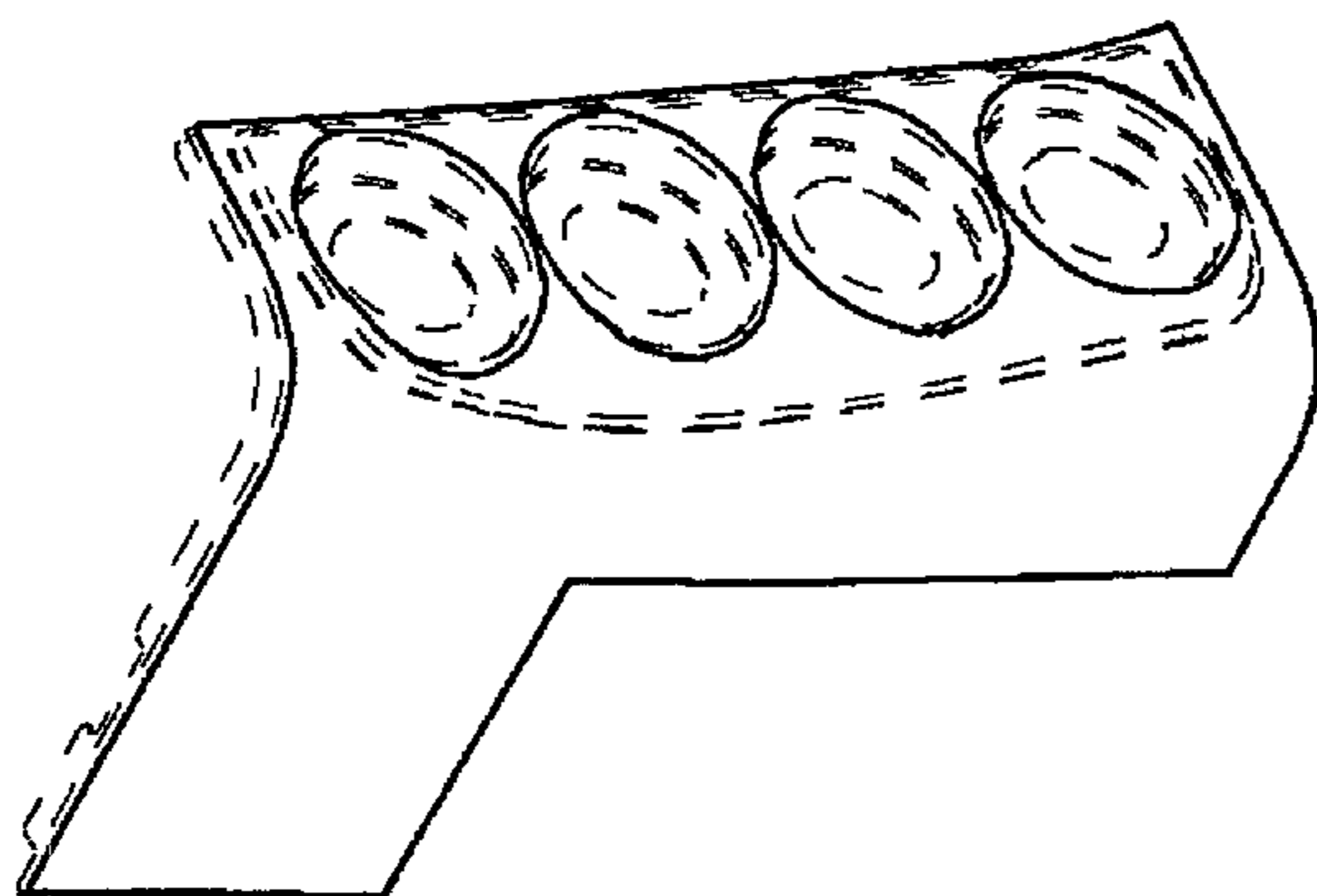
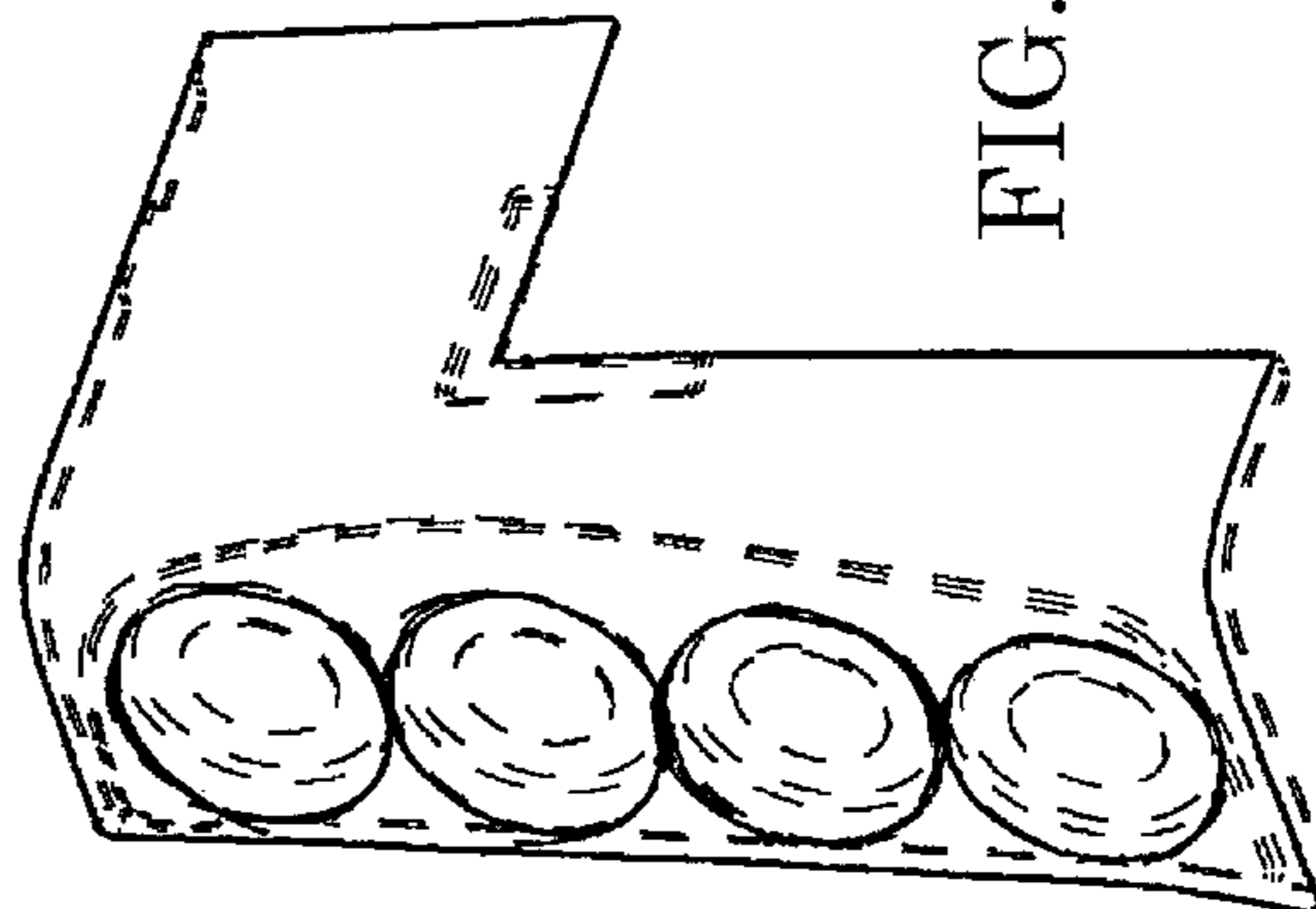

FIG. 27

FIG. 28



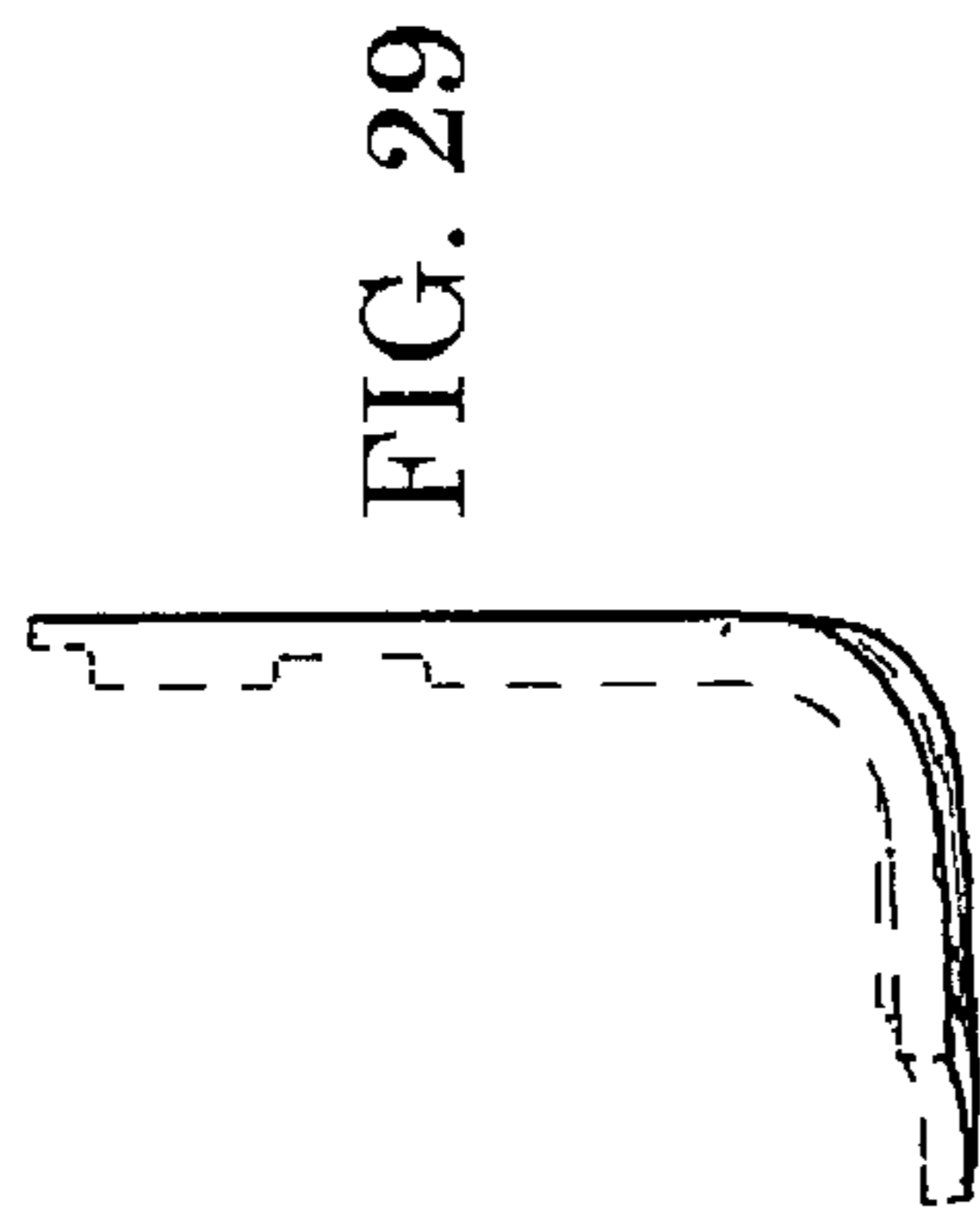

FIG. 30

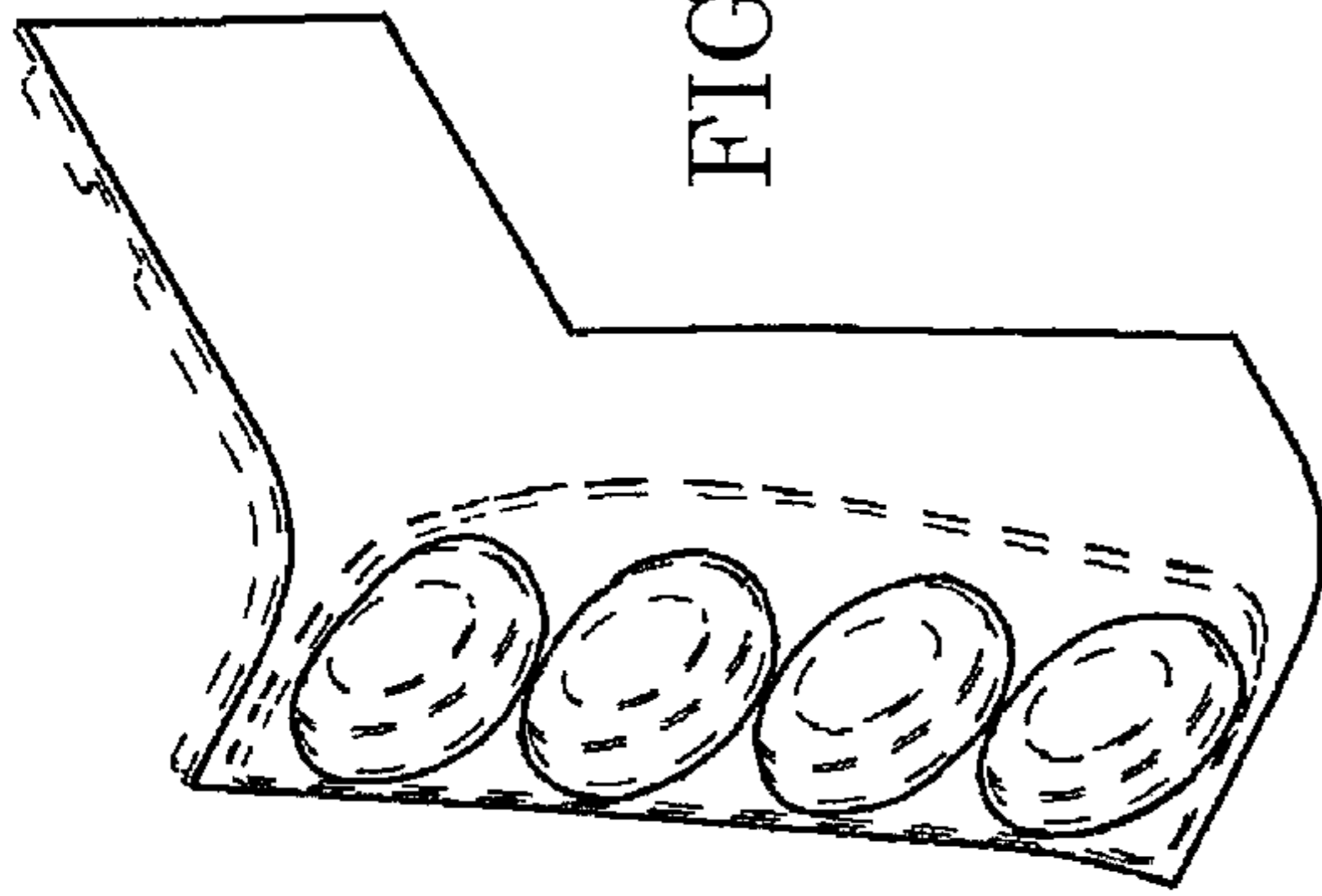
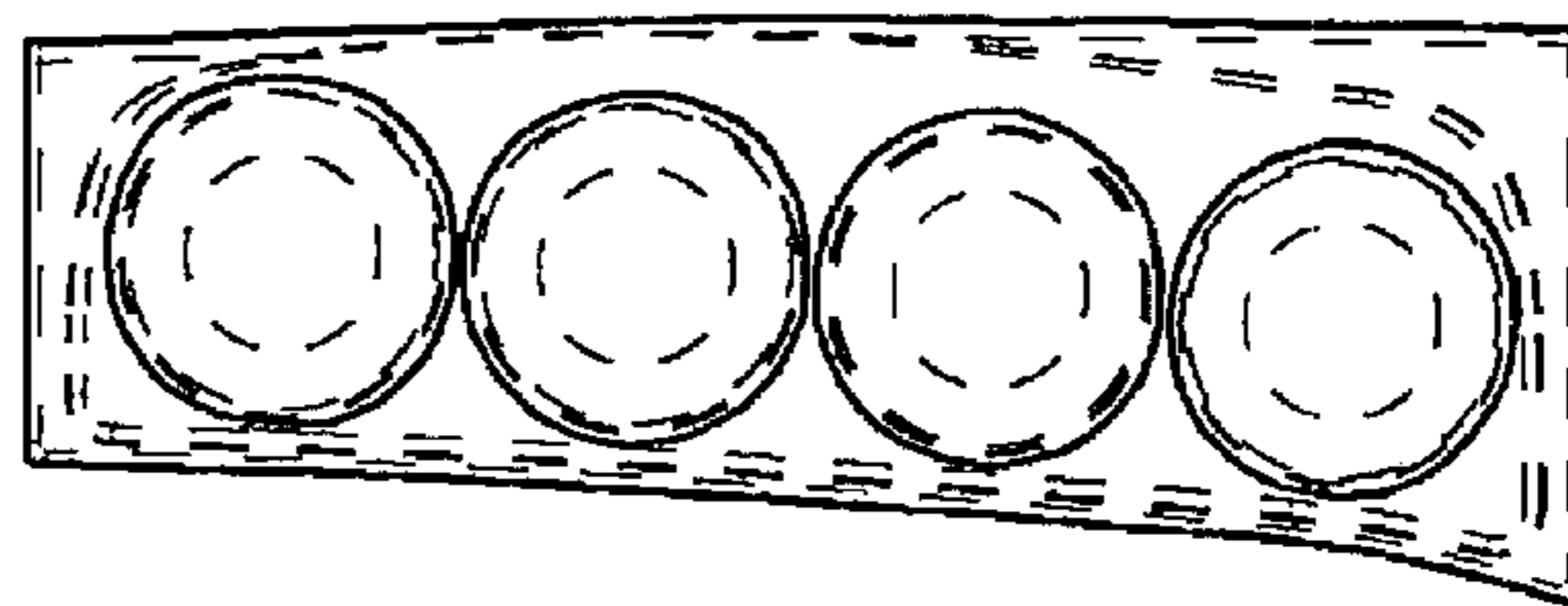

FIG. 33

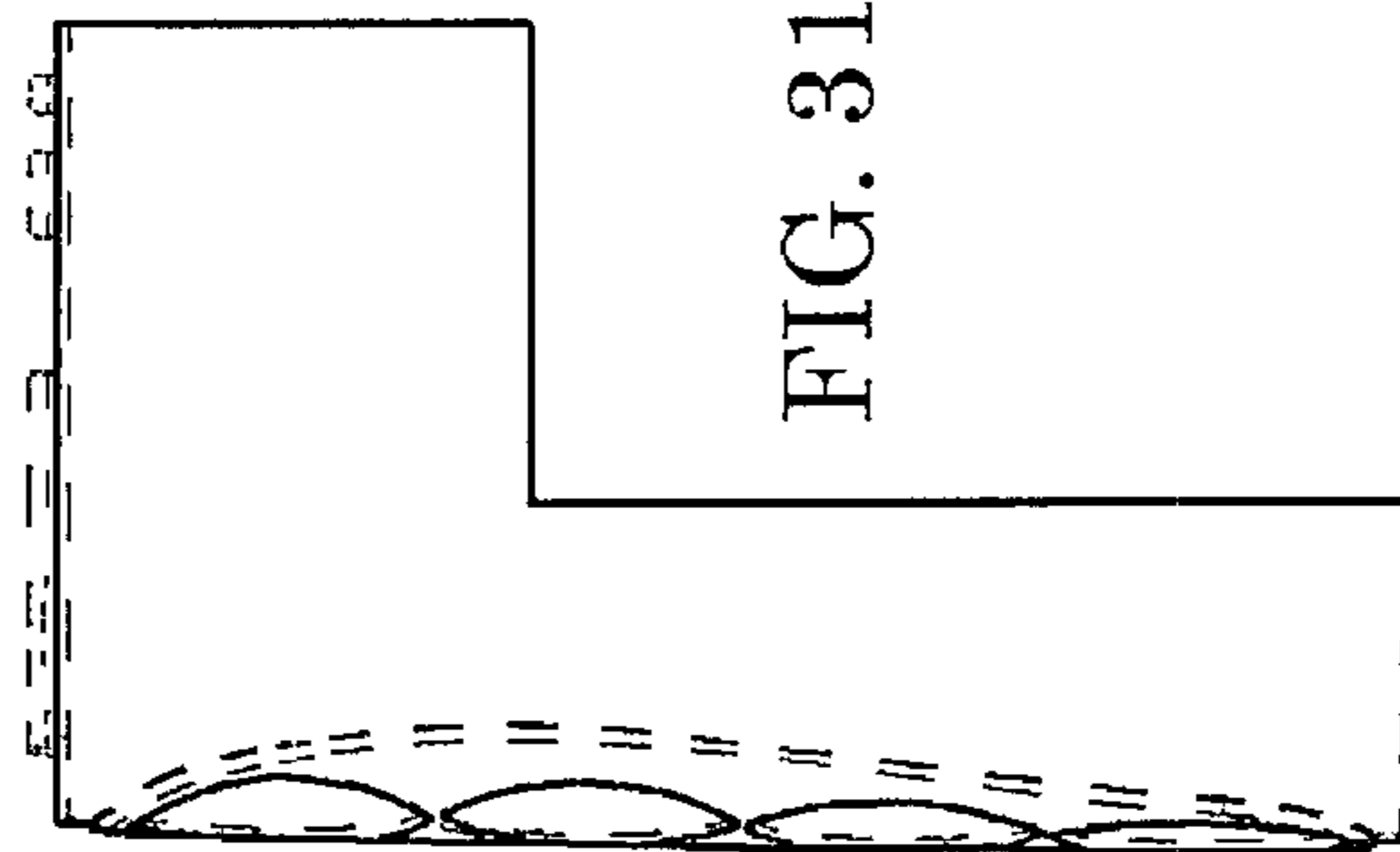
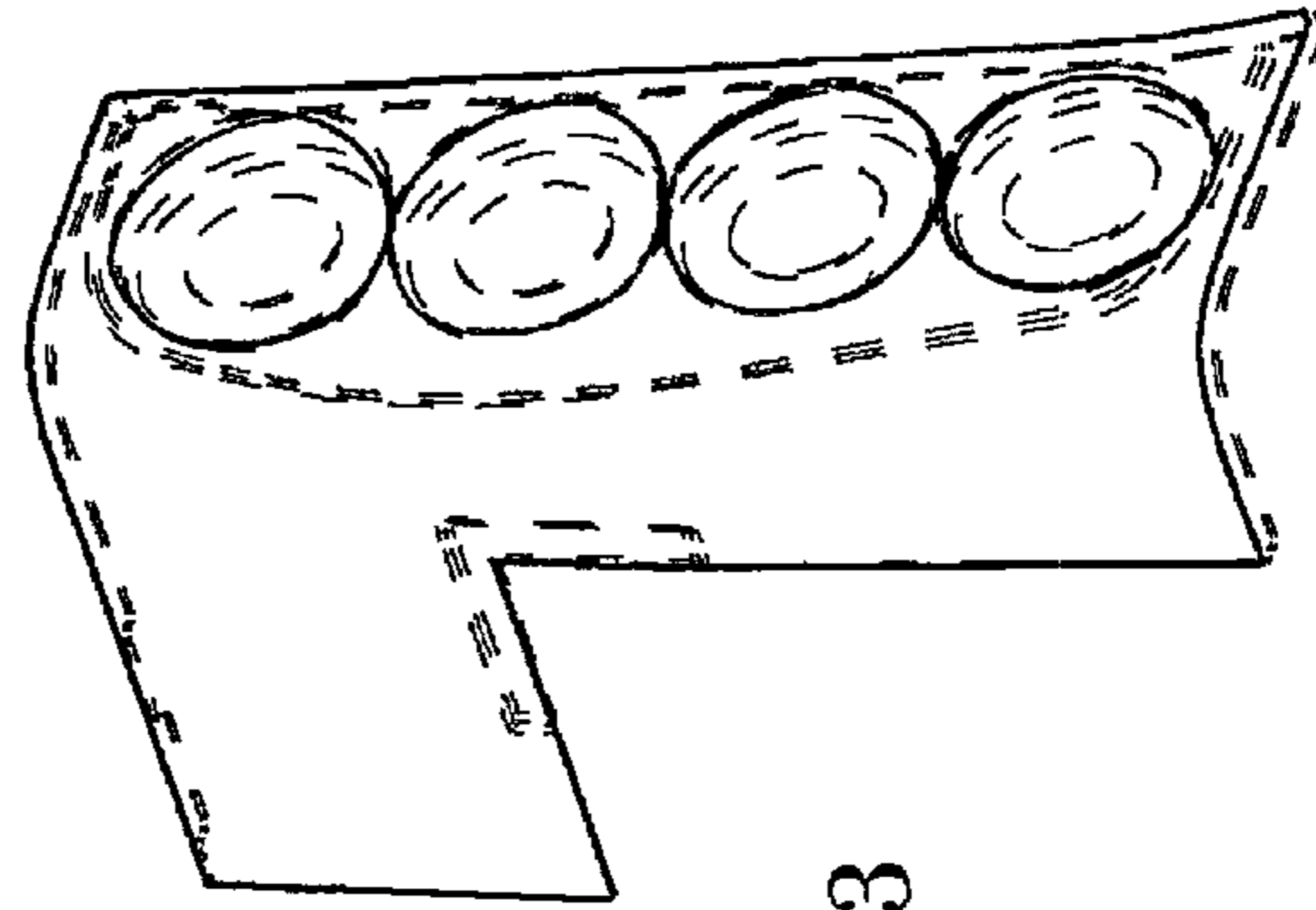

FIG. 31

FIG. 33