



US00D687513S

(12) **United States Design Patent**
Williams et al.

(10) **Patent No.:** **US D687,513 S**

(45) **Date of Patent:** **** Aug. 6, 2013**

(54) **SHOWER HOSE FILTER ASSEMBLY**

(75) Inventors: **Brian R. Williams**, Fort Collins, CO
(US); **Harold A. Luetngen**, Windsor, CO
(US)

(73) Assignee: **Water Pik, Inc.**, Fort Collins, CO (US)

(**) Term: **14 Years**

(21) Appl. No.: **29/417,964**

(22) Filed: **Apr. 11, 2012**

(51) **LOC (9) Cl.** **23-01**

(52) **U.S. Cl.**
USPC **D23/209**; D23/266

(58) **Field of Classification Search**
USPC D23/207, 209, 266, 228; 210/282,
210/460, 449; 239/553
See application file for complete search history.

(56) **References Cited**

U.S. PATENT DOCUMENTS

2,988,288	A *	6/1961	Nielsen	239/428.5
7,866,576	B1 *	1/2011	Farley	239/553
8,268,168	B2 *	9/2012	Mang	210/137

* cited by examiner

Primary Examiner — Robin V Webster

(74) *Attorney, Agent, or Firm* — Dorsey & Whitney LLP

(57) **CLAIM**

We claim the ornamental design for a shower hose filter assembly, substantially as shown and described.

DESCRIPTION

FIG. 1 is a front isometric view of a shower hose filter assembly.

FIG. 2 is a front elevation view of the shower hose filter assembly of FIG. 1.

FIG. 3 is a rear elevation view of the shower hose filter assembly of FIG. 1.

FIG. 4 is a right side elevation view of the shower hose filter assembly of FIG. 1.

FIG. 5 is a left side elevation view of the shower hose filter assembly of FIG. 1.

FIG. 6 is a top plan view of the shower hose filter assembly of FIG. 1.

FIG. 7 is a bottom plan view of the shower hose filter assembly of FIG. 1.

FIG. 8 is an exploded front isometric view of the shower hose filter assembly of FIG. 1.

FIG. 9 is an exploded front elevation view of the shower hose filter assembly of FIG. 1.

FIG. 10 is an exploded rear elevation view of the shower hose filter assembly of FIG. 1.

FIG. 11 is an exploded right side elevation view of the shower hose filter assembly of FIG. 1; and,

FIG. 12 is an exploded left side elevation view of the shower hose filter assembly of FIG. 1.

The broken lines, which define the bounds of the claimed design, form no part of the claimed design.

1 Claim, 8 Drawing Sheets

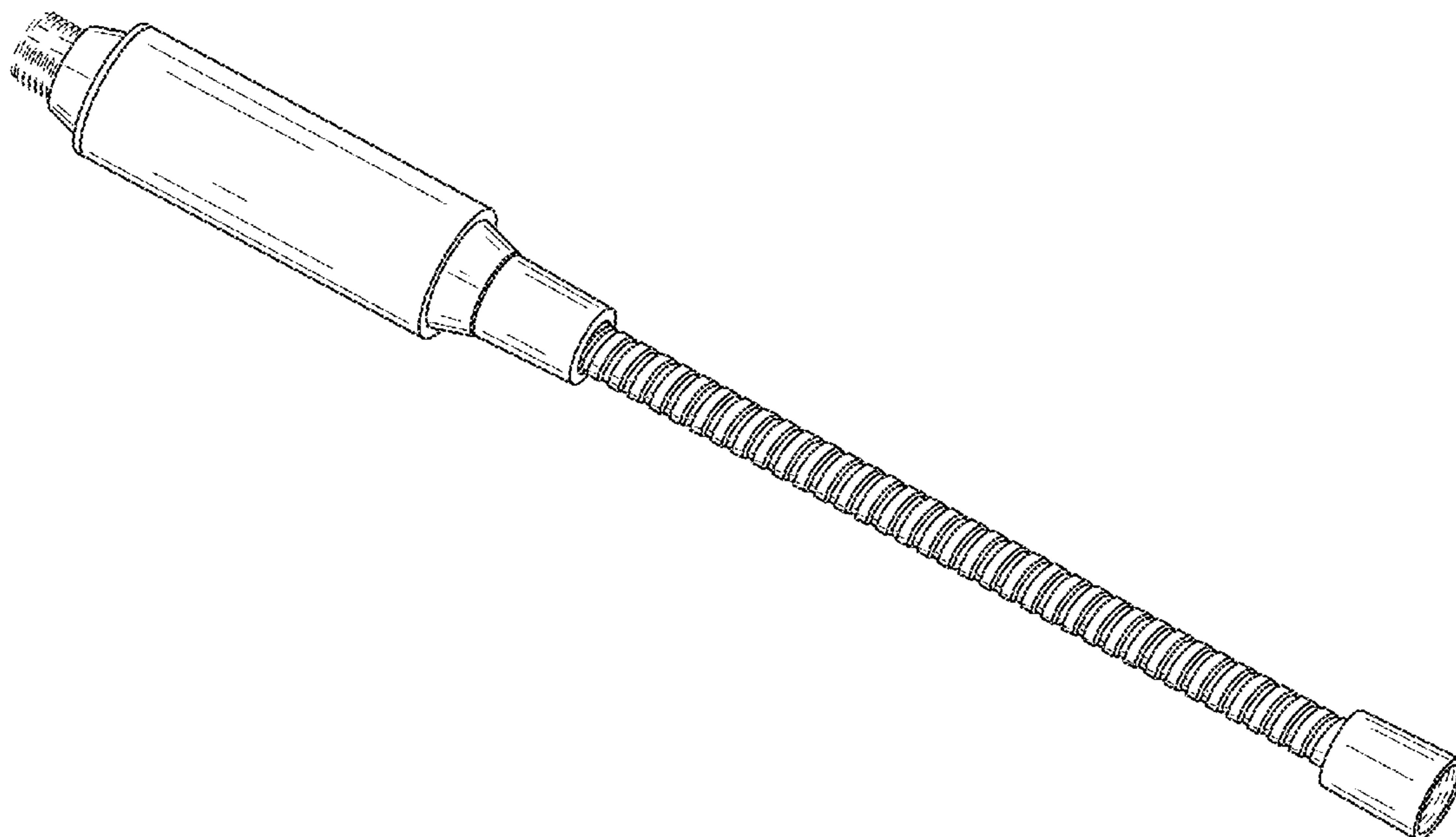

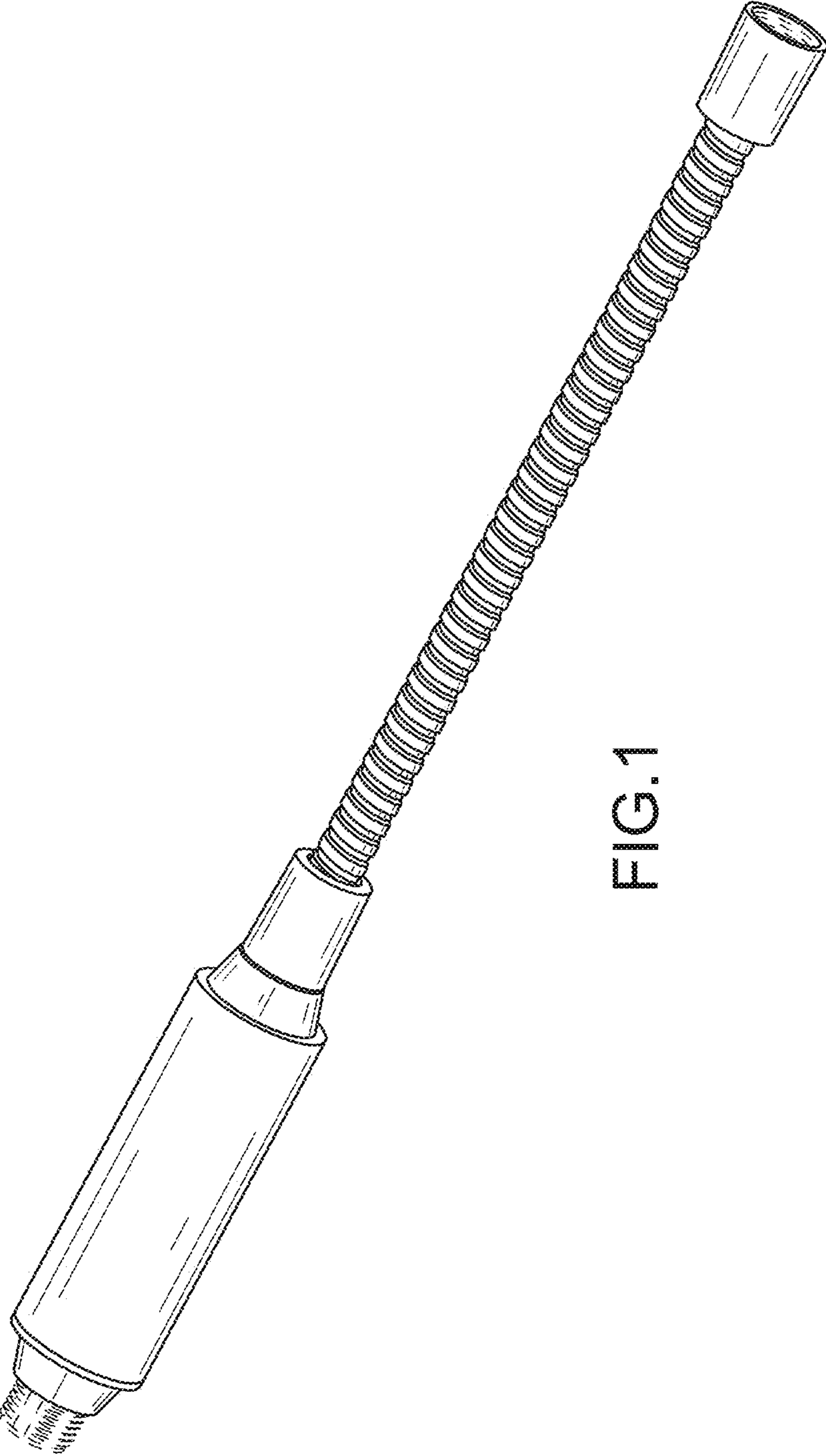

FIG.1

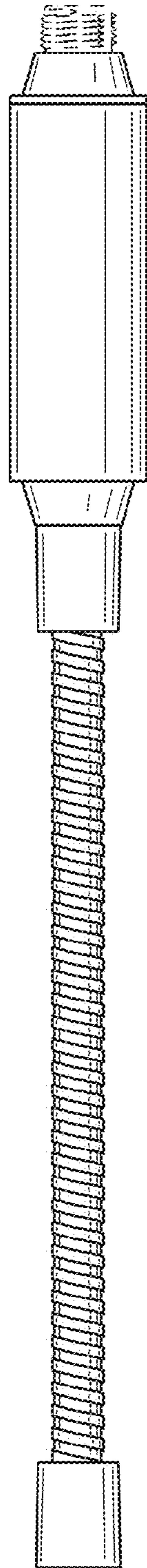

FIG. 2

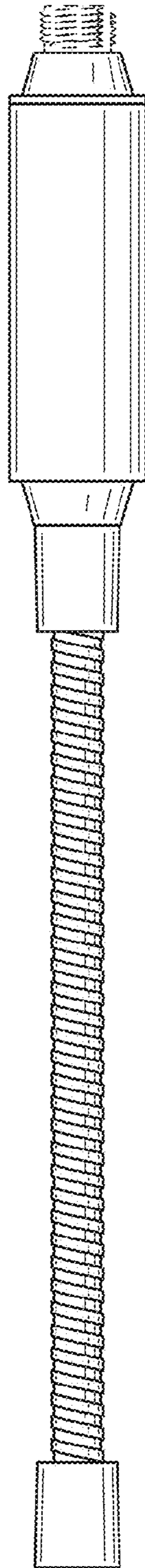

FIG. 3

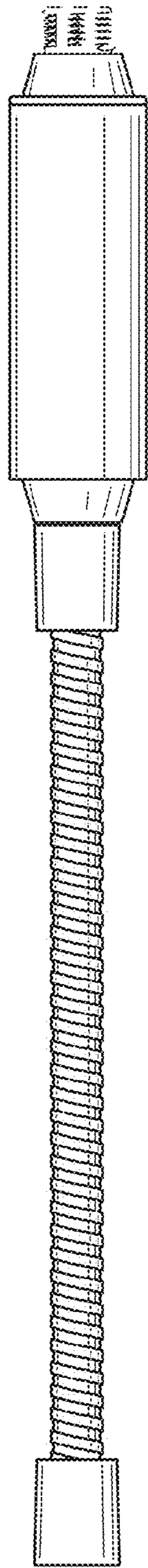

FIG. 4

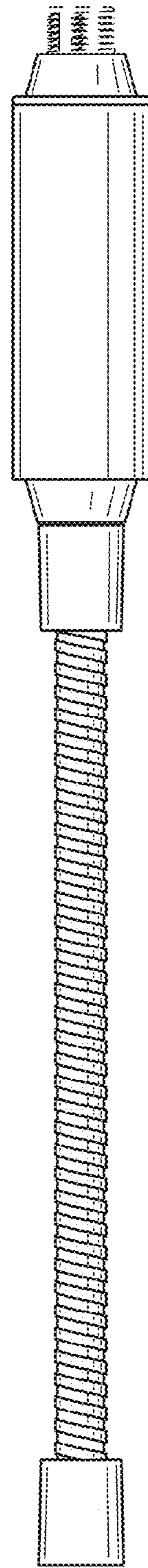

FIG. 5

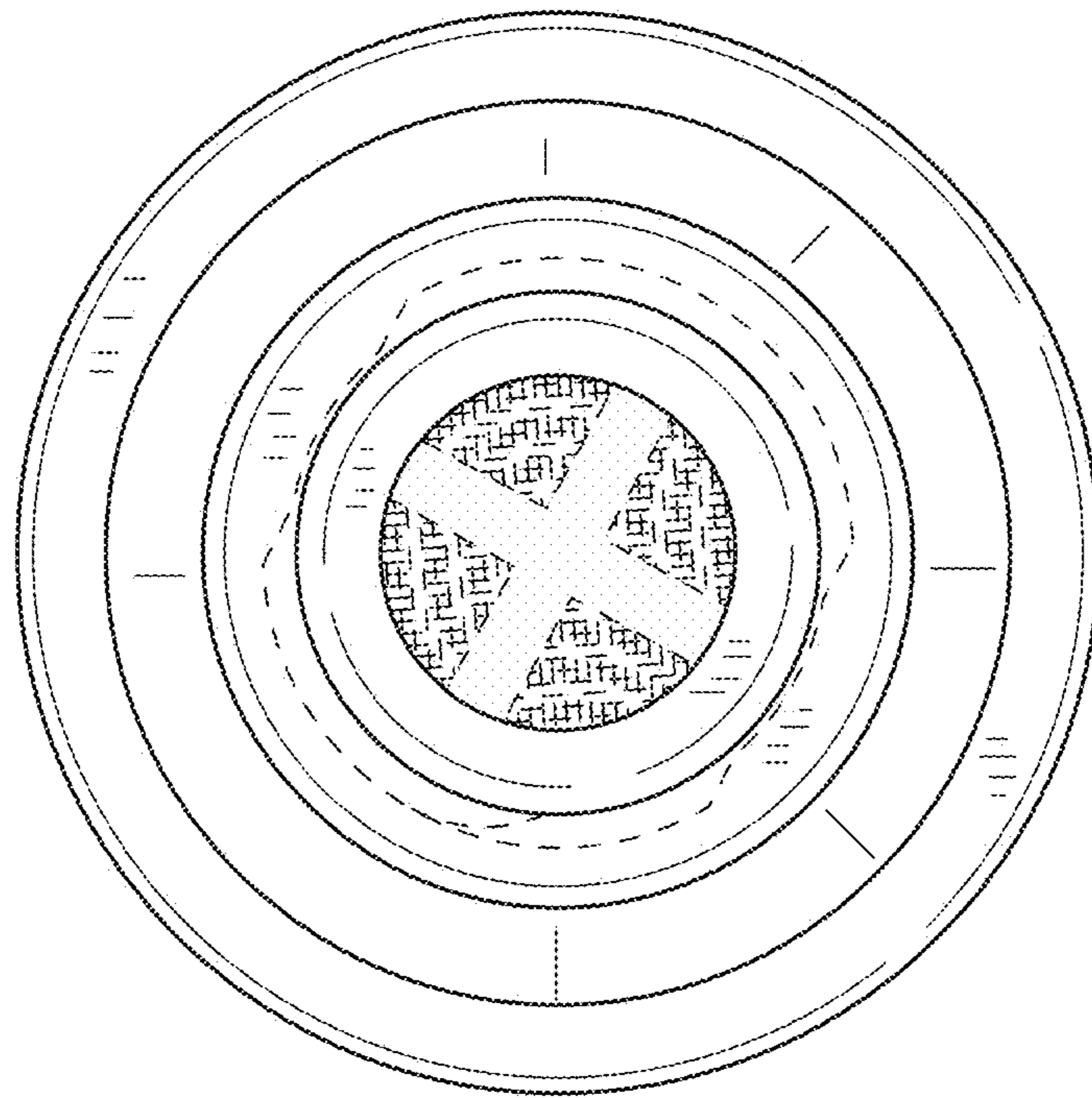

FIG.6

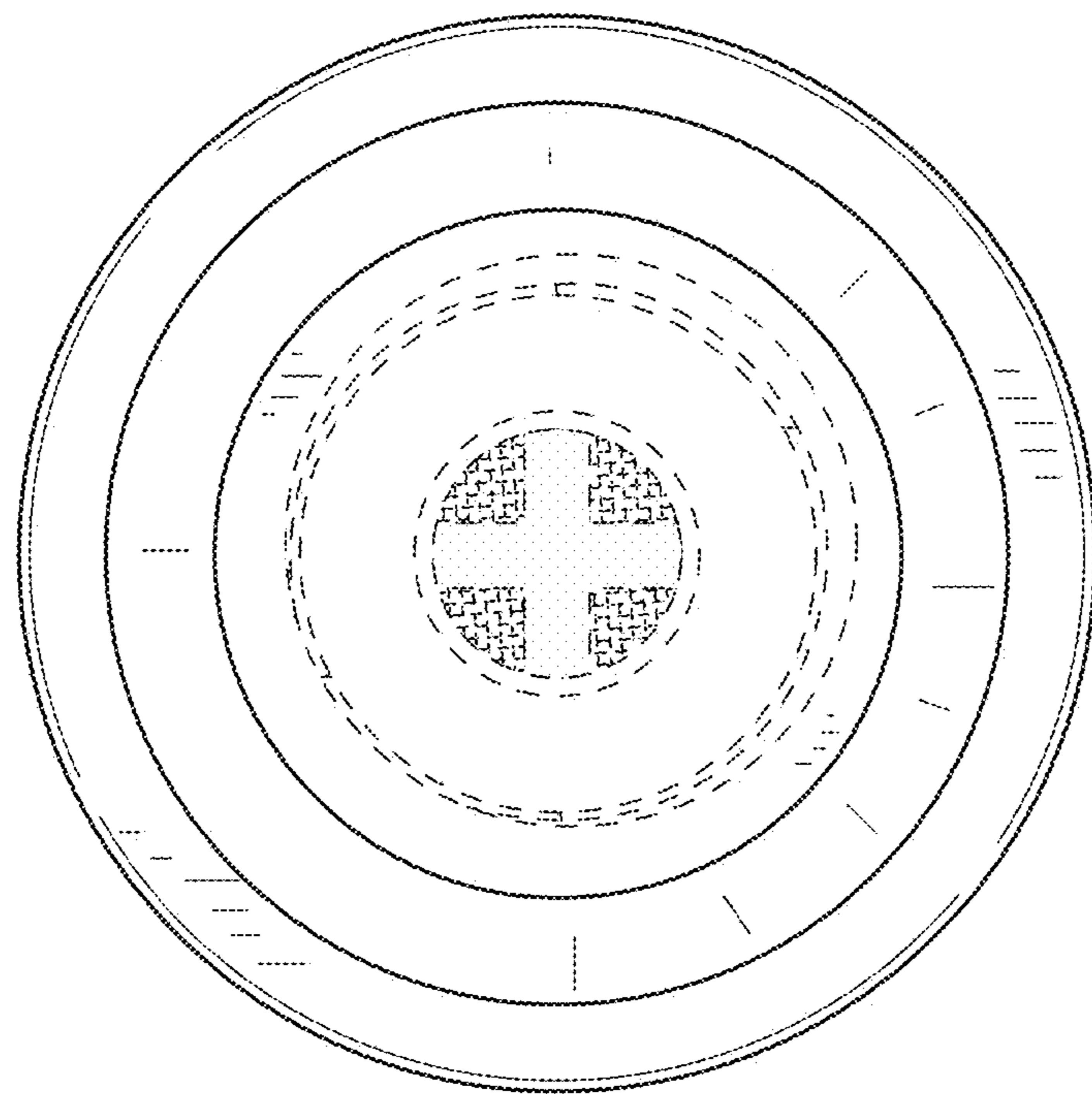

FIG. 7

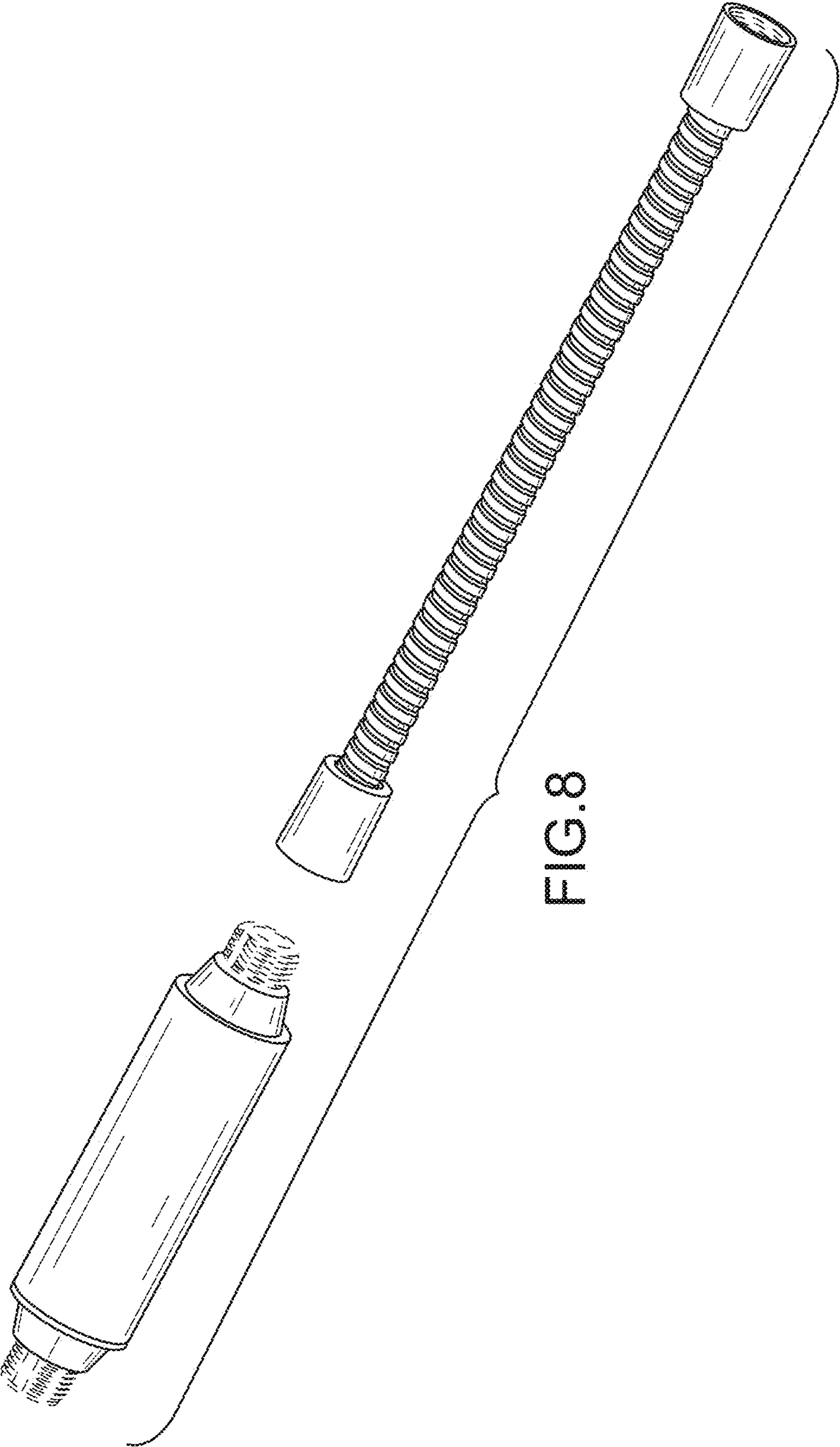

FIG. 8

FIG.9

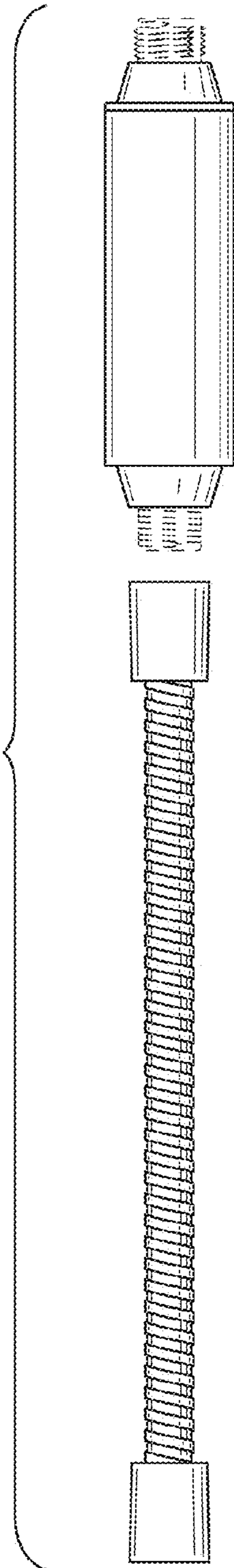

FIG.10

