



US00D687503S

(12) **United States Design Patent**  
**Solheim et al.**

(10) **Patent No.:** **US D687,503 S**

(45) **Date of Patent:** **\*\* Aug. 6, 2013**

(54) **GOLF CLUB HEAD**

*Primary Examiner* — Mitchell Siegel

(71) Applicant: **Karsten Manufacturing Corporation,**  
Phoenix, AZ (US)

(72) Inventors: **John A. Solheim,** Phoenix, AZ (US);  
**Ryan M. Stokke,** Phoenix, AZ (US);  
**Xiaojian Chen,** Phoenix, AZ (US)

(73) Assignee: **Karsten Manufacturing Corporation,**  
Phoenix, AZ (US)

(\*\*) Term: **14 Years**

(21) Appl. No.: **29/447,491**

(22) Filed: **Mar. 4, 2013**

(51) **LOC (9) Cl.** ..... **21-02**

(52) **U.S. Cl.**  
USPC ..... **D21/759**

(58) **Field of Classification Search**  
USPC ..... D21/733, 752, 759; 473/324–331,  
473/343–346

See application file for complete search history.

(56) **References Cited**

**U.S. PATENT DOCUMENTS**

1,993,928	A	3/1935	Glover	
2,041,676	A *	5/1936	Gallagher	473/327
2,756,055	A	7/1956	Bittner	
D248,179	S	6/1978	Riley	
4,139,196	A	2/1979	Riley	

(Continued)

**OTHER PUBLICATIONS**

Xiaojian Chen, et al, "Golf Club Head," U.S. Appl. No. 29/437,030,  
filed Nov. 12, 2012.

(Continued)

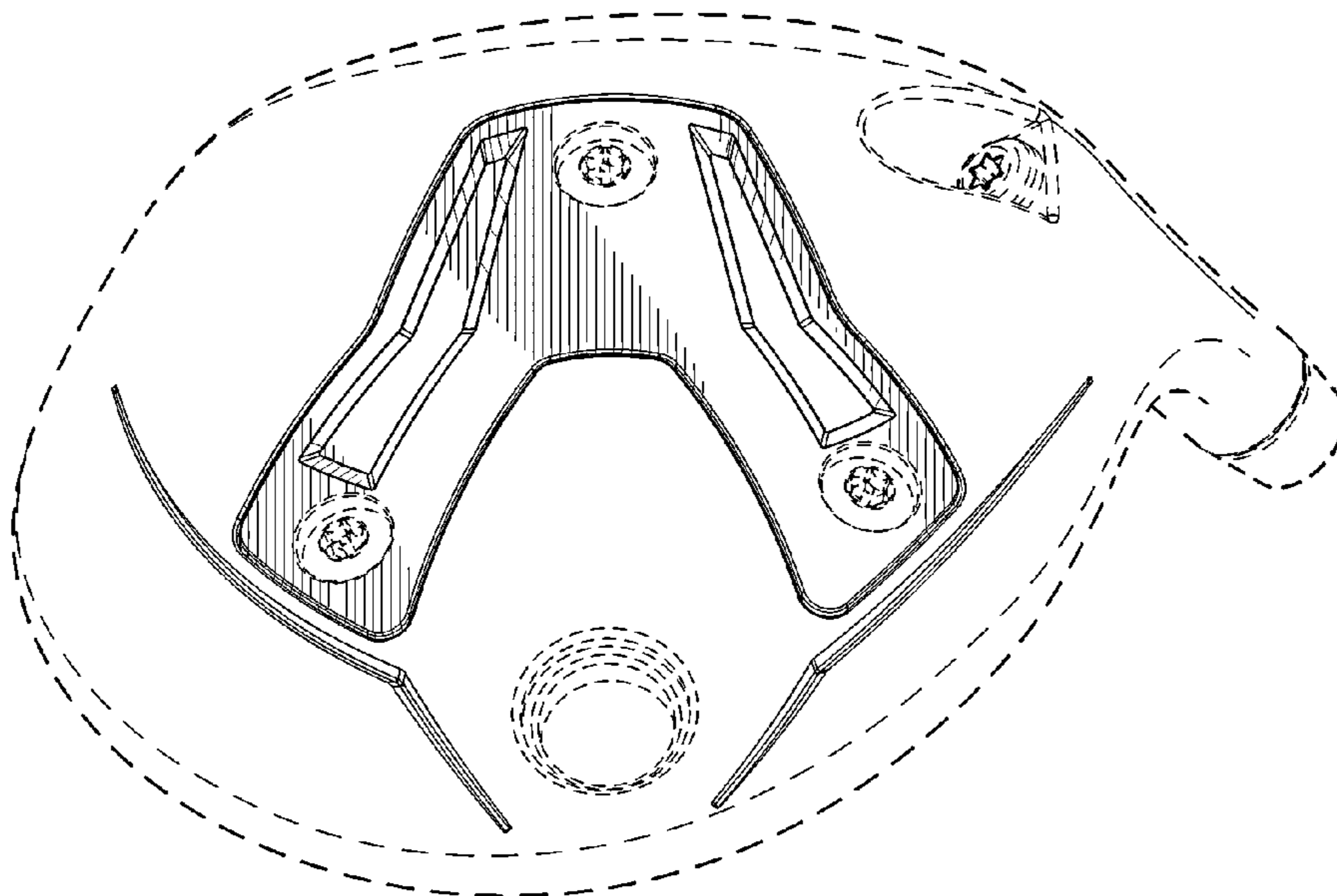
(57) **CLAIM**

The ornamental design for a golf club head, as shown and described.

**DESCRIPTION**

FIG. 1 is a top perspective view of a golf club head;  
 FIG. 2 is a bottom perspective view of the golf club head of FIG. 1;  
 FIG. 3 is a front elevational view of the golf club head of FIG. 1;  
 FIG. 4 is a rear elevational view of the golf club head of FIG. 1;  
 FIG. 5 is a top view of the golf club head of FIG. 1;  
 FIG. 6 is a bottom view of the golf club head of FIG. 1;  
 FIG. 7 is a left side view of the golf club head of FIG. 1; and  
 FIG. 8 is a right side view of the golf club head of FIG. 1.  
 FIG. 9 is a top perspective view of a golf club head;  
 FIG. 10 is a bottom perspective view of the golf club head of FIG. 9;  
 FIG. 11 is a front elevational view of the golf club head of FIG. 9;  
 FIG. 12 is a rear elevational view of the golf club head of FIG. 9;  
 FIG. 13 is a top view of the golf club head of FIG. 9;  
 FIG. 14 is a bottom view of the golf club head of FIG. 9;  
 FIG. 15 is a left side view of the golf club head of FIG. 9; and,  
 FIG. 16 is a right side view of the golf club head of FIG. 9.  
 The broken lines shown in one or more of the figures are for illustrative purposes only and form no part of the claimed design.

**1 Claim, 8 Drawing Sheets**



(56)

References Cited

U.S. PATENT DOCUMENTS

D307,783 S 5/1990 Iinuma  
 5,221,086 A 6/1993 Antonious  
 5,310,186 A 5/1994 Karsten  
 5,335,914 A 8/1994 Long  
 D352,755 S 11/1994 Cornish, III  
 D357,290 S 4/1995 Viollaz  
 5,547,188 A 8/1996 Dumontier  
 D379,391 S 5/1997 Moore  
 5,658,206 A 8/1997 Antonious  
 D383,511 S 9/1997 Lo  
 5,795,245 A 8/1998 Chang  
 D398,682 S 9/1998 Moore  
 D402,340 S 12/1998 Sheets  
 D404,098 S 1/1999 Ishikawa  
 5,980,394 A 11/1999 Domas  
 D418,888 S 1/2000 Williams  
 D425,589 S 5/2000 Ishikawa  
 D426,604 S 6/2000 Besnard  
 6,074,310 A 6/2000 Ota  
 6,080,069 A 6/2000 Long  
 D433,073 S \* 10/2000 Sodano ..... D21/752  
 D441,818 S 5/2001 Sato  
 D442,245 S 5/2001 Roach  
 D445,470 S 7/2001 Teramoto  
 D446,268 S 8/2001 Satoh  
 D446,563 S 8/2001 Besnard  
 D461,865 S 8/2002 Nagai  
 D463,838 S 10/2002 Besnard  
 D465,251 S 11/2002 Wood  
 6,475,102 B2 11/2002 Helmstetter  
 D469,141 S 1/2003 Poynor  
 D472,950 S 4/2003 Burnett  
 D482,421 S 11/2003 Kessler  
 D490,489 S 5/2004 Madore  
 D492,745 S 7/2004 Tang  
 D501,036 S \* 1/2005 Burrows ..... D21/752  
 D502,976 S 3/2005 Nishitani  
 D508,544 S 8/2005 Madore  
 D509,272 S 9/2005 Smith  
 6,939,247 B1 9/2005 Schweigert  
 D513,424 S 1/2006 Erickson  
 D514,179 S 1/2006 Chen  
 6,988,960 B2 1/2006 Mahaffey  
 D518,129 S 3/2006 Poynor  
 D518,543 S 4/2006 Aguinaldo  
 D521,093 S 5/2006 Jorgensen  
 D522,077 S 5/2006 Schweigert  
 D522,601 S 6/2006 Schweigert  
 D523,103 S 6/2006 Hocknell  
 D523,498 S 6/2006 Chen  
 D523,502 S 6/2006 Jorgensen  
 D526,694 S 8/2006 Schweigert  
 D529,111 S 9/2006 Cleveland  
 D530,761 S 10/2006 Evans  
 D532,473 S 11/2006 Chen  
 D532,474 S 11/2006 Bennett  
 D532,854 S 11/2006 Oldknow  
 D535,343 S 1/2007 Chen  
 D536,049 S 1/2007 Evans  
 D537,139 S 2/2007 Breier  
 D537,495 S 2/2007 Schweigert  
 D537,496 S 2/2007 Serrano  
 D537,895 S 3/2007 Breier  
 D538,363 S 3/2007 Schweigert  
 D538,371 S 3/2007 Kawami  
 D538,866 S 3/2007 Kim  
 D538,867 S 3/2007 Cleveland  
 D539,371 S 3/2007 Serrano  
 D541,364 S 4/2007 Barez  
 D545,389 S \* 6/2007 Glod ..... D21/759  
 D547,815 S 7/2007 Tang  
 D550,318 S 9/2007 Oldknow  
 D550,799 S 9/2007 Lin  
 D552,198 S 10/2007 Schweigert  
 D553,206 S 10/2007 Morales

D555,745 S 11/2007 Rollinson  
 D557,362 S 12/2007 Serrano  
 D557,363 S 12/2007 Jertson  
 D558,287 S 12/2007 Jertson  
 D558,288 S 12/2007 Jertson  
 D561,286 S 2/2008 Morales  
 D562,421 S 2/2008 Jertson  
 7,326,472 B2 2/2008 Shimazaki  
 D563,498 S 3/2008 Jertson  
 D564,054 S 3/2008 Jertson  
 D564,055 S 3/2008 Jertson  
 D564,056 S 3/2008 Chen  
 D566,214 S 4/2008 Evans  
 D567,317 S 4/2008 Jertson  
 D567,891 S 4/2008 Serrano  
 D569,933 S 5/2008 Jertson  
 D569,934 S 5/2008 Jertson  
 D569,935 S 5/2008 Schweigert  
 D569,936 S 5/2008 Schweigert  
 D569,937 S 5/2008 Sanchez  
 D569,938 S 5/2008 Sanchez  
 D570,937 S 6/2008 Schweigert  
 D570,938 S 6/2008 Jertson  
 D570,939 S 6/2008 Chen  
 D570,940 S 6/2008 Chen  
 D570,941 S 6/2008 Chen  
 D571,882 S 6/2008 Soracco  
 D572,324 S 7/2008 Chen  
 D572,782 S 7/2008 Sanchez  
 D572,783 S 7/2008 Sanchez  
 D572,784 S 7/2008 Sanchez  
 D572,785 S 7/2008 Chen  
 D572,787 S 7/2008 Sanchez  
 D572,791 S 7/2008 Jertson  
 D573,213 S 7/2008 Sanchez  
 D573,214 S 7/2008 Sanchez  
 D573,215 S 7/2008 Sanchez  
 D573,216 S 7/2008 Sanchez  
 D573,217 S 7/2008 Sanchez  
 D573,218 S 7/2008 Sanchez  
 D573,674 S 7/2008 Sanchez  
 D573,675 S 7/2008 Sanchez  
 D573,676 S 7/2008 Chen  
 D573,678 S 7/2008 Kawami  
 D574,046 S 7/2008 Chen  
 D574,048 S 7/2008 Kadoya  
 D574,049 S 7/2008 Kadoya  
 D574,050 S 7/2008 Jones  
 7,396,296 B2 7/2008 Evans  
 D574,456 S 8/2008 Chen  
 D578,587 S 10/2008 Hoffman  
 D579,066 S 10/2008 Dipert  
 D579,067 S 10/2008 Hoffman  
 D580,504 S 11/2008 Bosilkovski  
 D583,432 S 12/2008 Serrano  
 D587,772 S 3/2009 Ferguson  
 D588,217 S 3/2009 Jertson  
 D588,220 S 3/2009 Ferguson  
 D588,659 S 3/2009 Jertson  
 D589,576 S 3/2009 Kadoya  
 7,503,854 B2 3/2009 Galloway  
 D591,810 S 5/2009 Murphy  
 D591,817 S 5/2009 Murphy  
 D591,818 S 5/2009 Roberts  
 D594,518 S 6/2009 Schweigert  
 D594,521 S 6/2009 Jertson  
 D594,919 S 6/2009 Schweigert  
 D595,381 S 6/2009 Waggoner  
 D596,252 S 7/2009 Jertson  
 D598,062 S 8/2009 Dipert  
 D600,297 S 9/2009 Jertson  
 D603,472 S 11/2009 Schweigert  
 D603,919 S 11/2009 Gray  
 D604,376 S 11/2009 Darley  
 D609,293 S 2/2010 Williams  
 D609,294 S 2/2010 Oldknow  
 D611,555 S 3/2010 Oldknow  
 D612,005 S 3/2010 Oldknow  
 D613,805 S 4/2010 Sutovsky

# US D687,503 S

Page 3

---

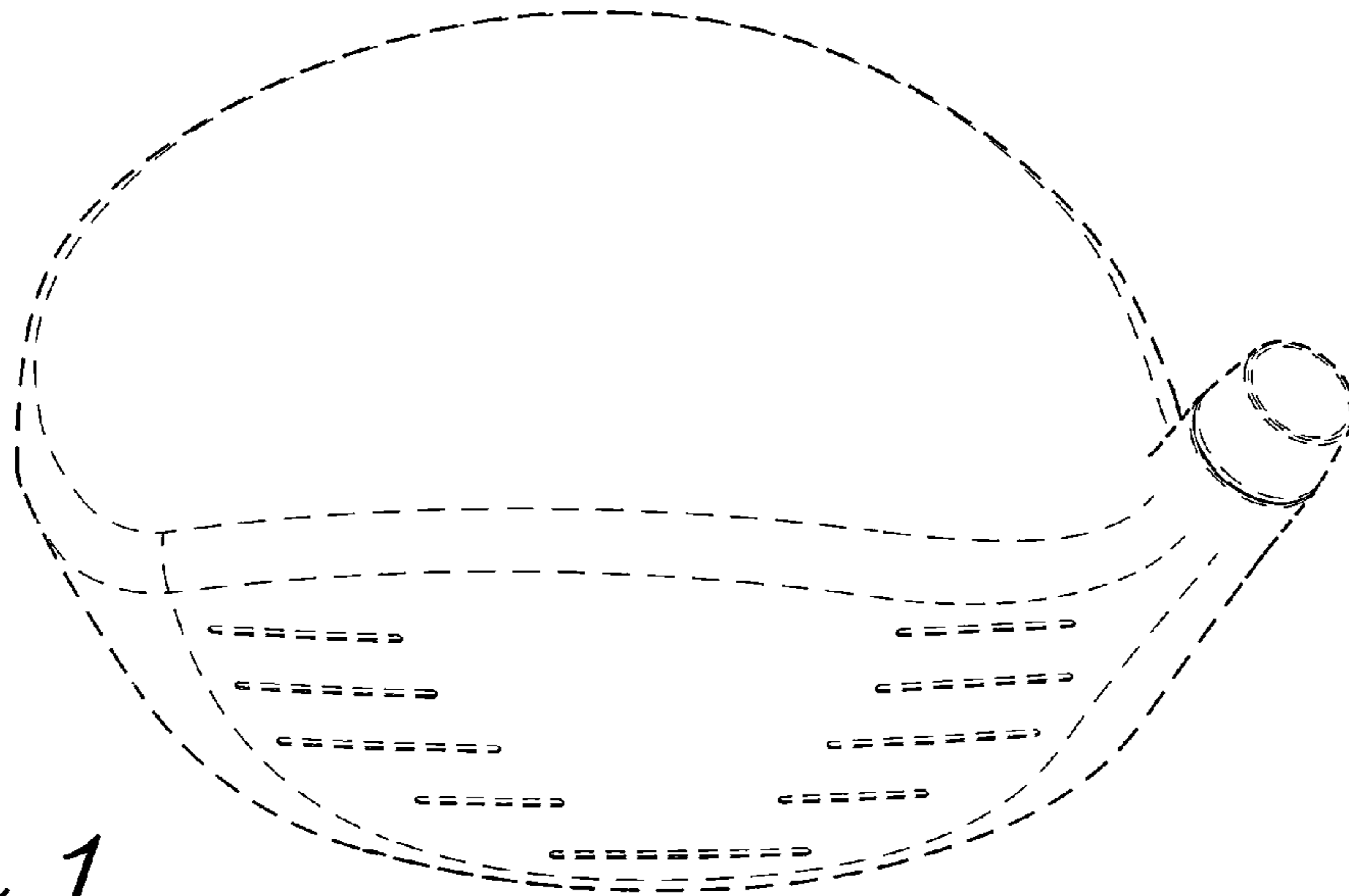
D618,747 S 6/2010 Schweigert  
D618,753 S 6/2010 Jertson  
D618,754 S 6/2010 Schweigert  
D621,892 S \* 8/2010 Kohno ..... D21/752  
7,892,111 B2 2/2011 Morales  
D635,626 S 4/2011 Nicolette  
D638,896 S 5/2011 Schweigert  
8,012,034 B1 9/2011 Cackett  
D654,130 S \* 2/2012 Glod ..... D21/759  
D661,751 S \* 6/2012 Nicolette et al. .... D21/752  
D661,752 S 6/2012 Stokke  
D661,756 S \* 6/2012 Nicolette et al. .... D21/759  
D661,757 S 6/2012 Stokke  
8,337,326 B2 12/2012 Lukasiewicz, Jr.

D673,630 S 1/2013 Schweigert  
2005/0043117 A1 2/2005 Gilbert  
2008/0039228 A1 2/2008 Breier  
2008/0171612 A1 7/2008 Serrano  
2008/0188322 A1 8/2008 Anderson  
2009/0275419 A1 11/2009 Cackett  
2011/0143858 A1 6/2011 Peralta

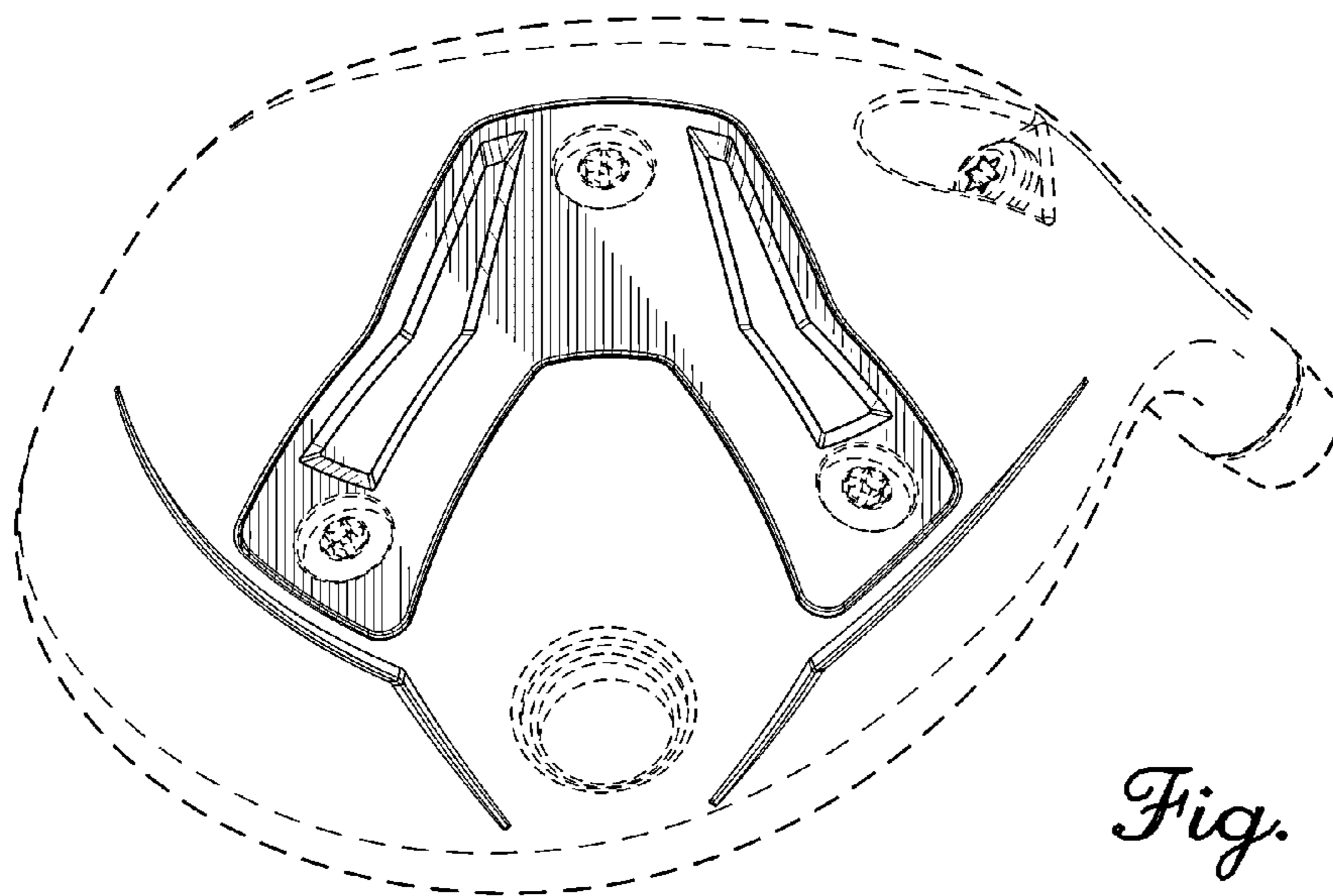
## OTHER PUBLICATIONS

John A. Solheim, et al., "Golf Club Head," U.S. Appl. No. 29/439,058, filed Dec. 6, 2012.

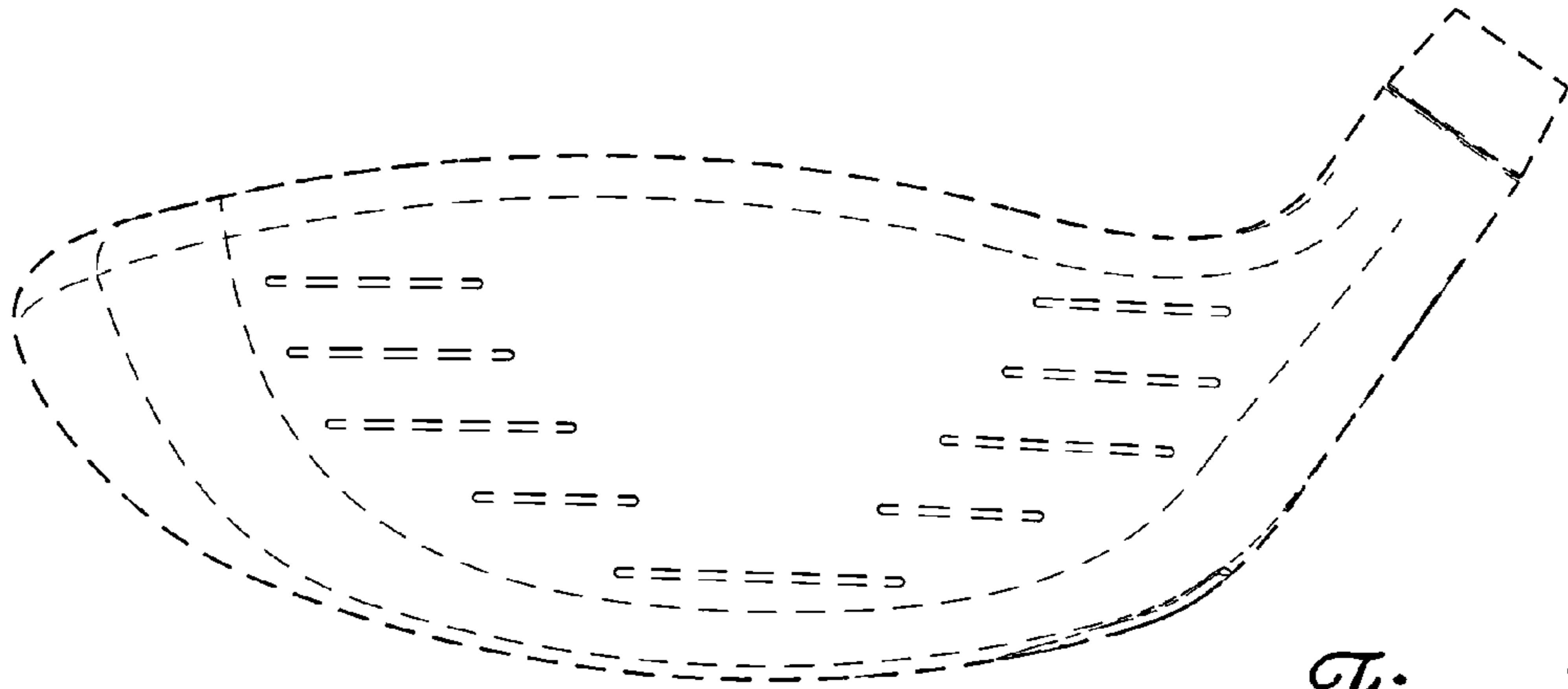
\* cited by examiner



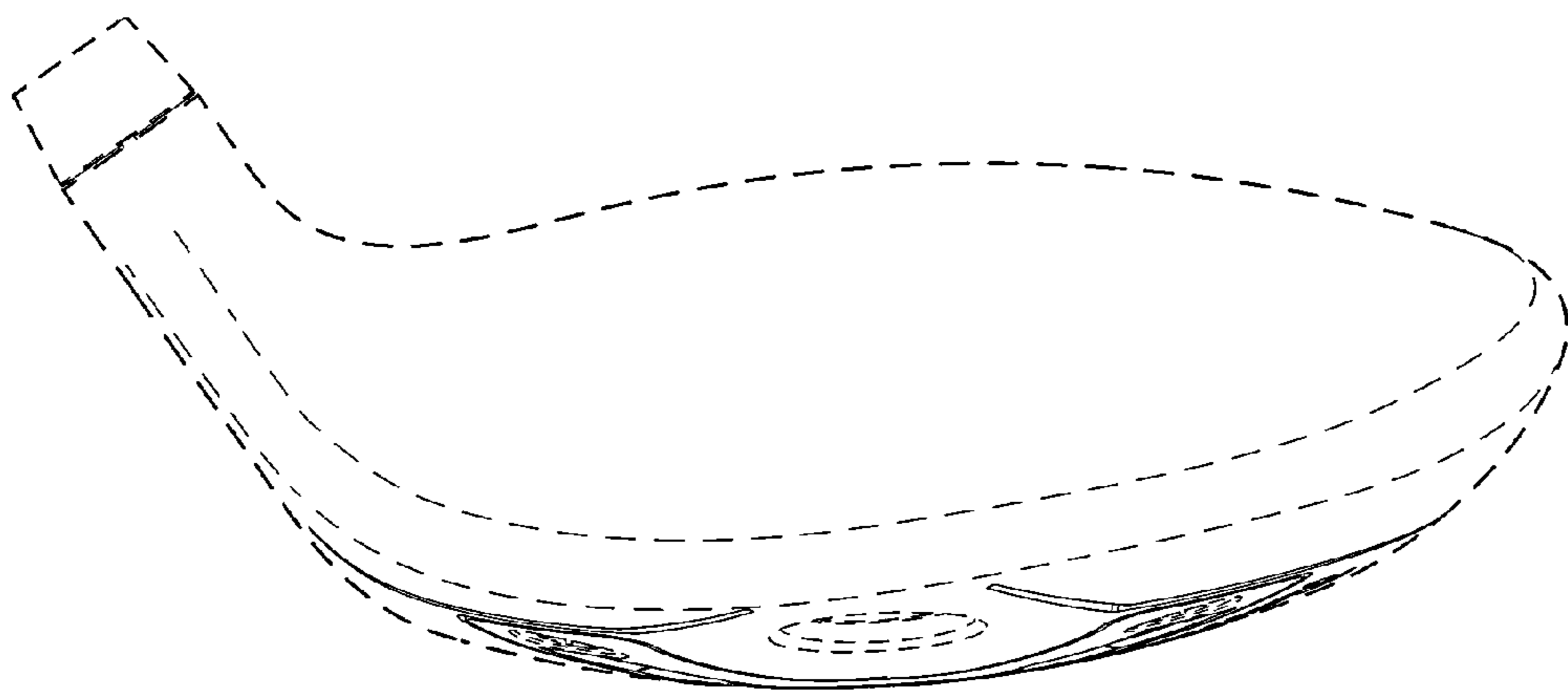
*Fig. 1*



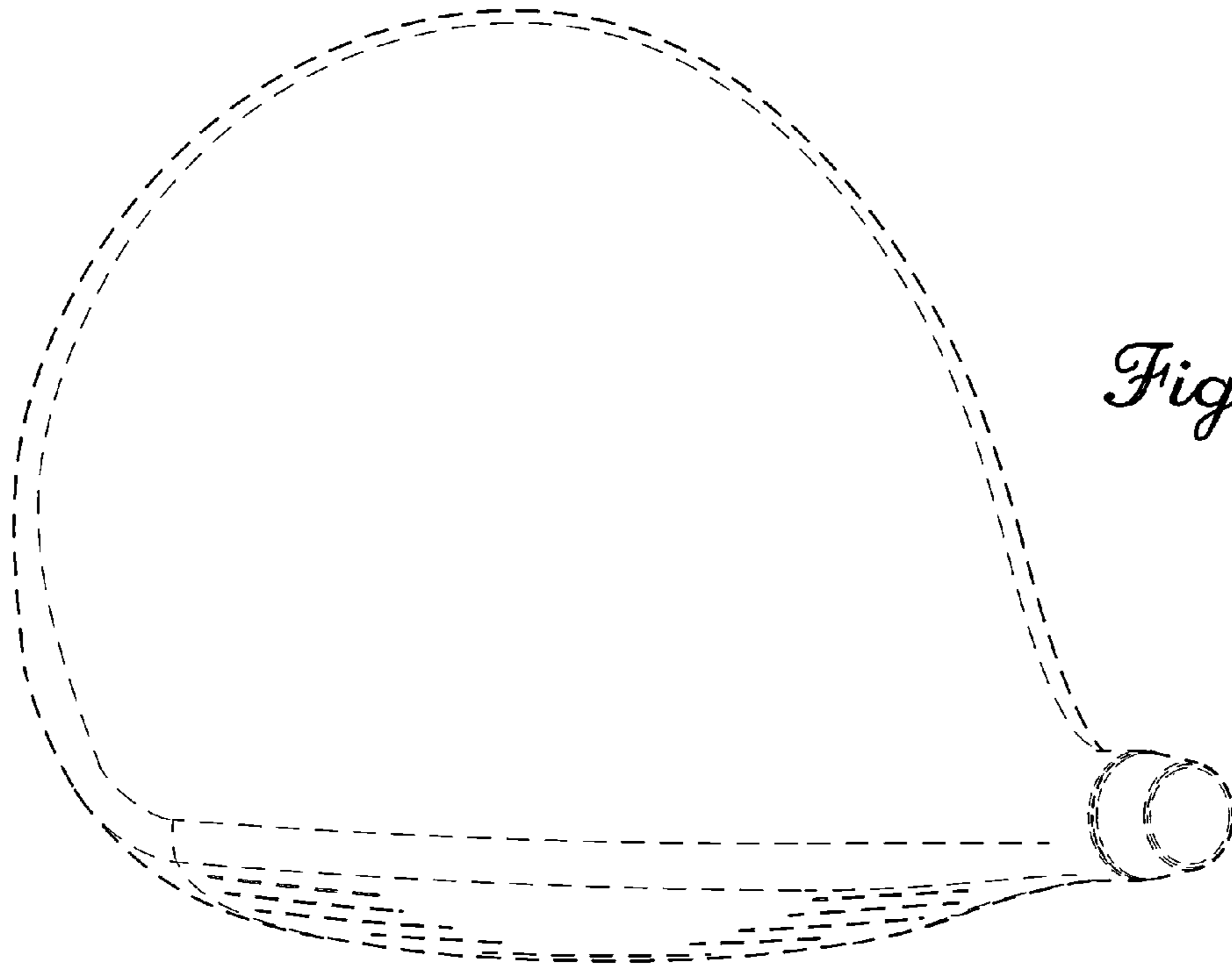
*Fig. 2*



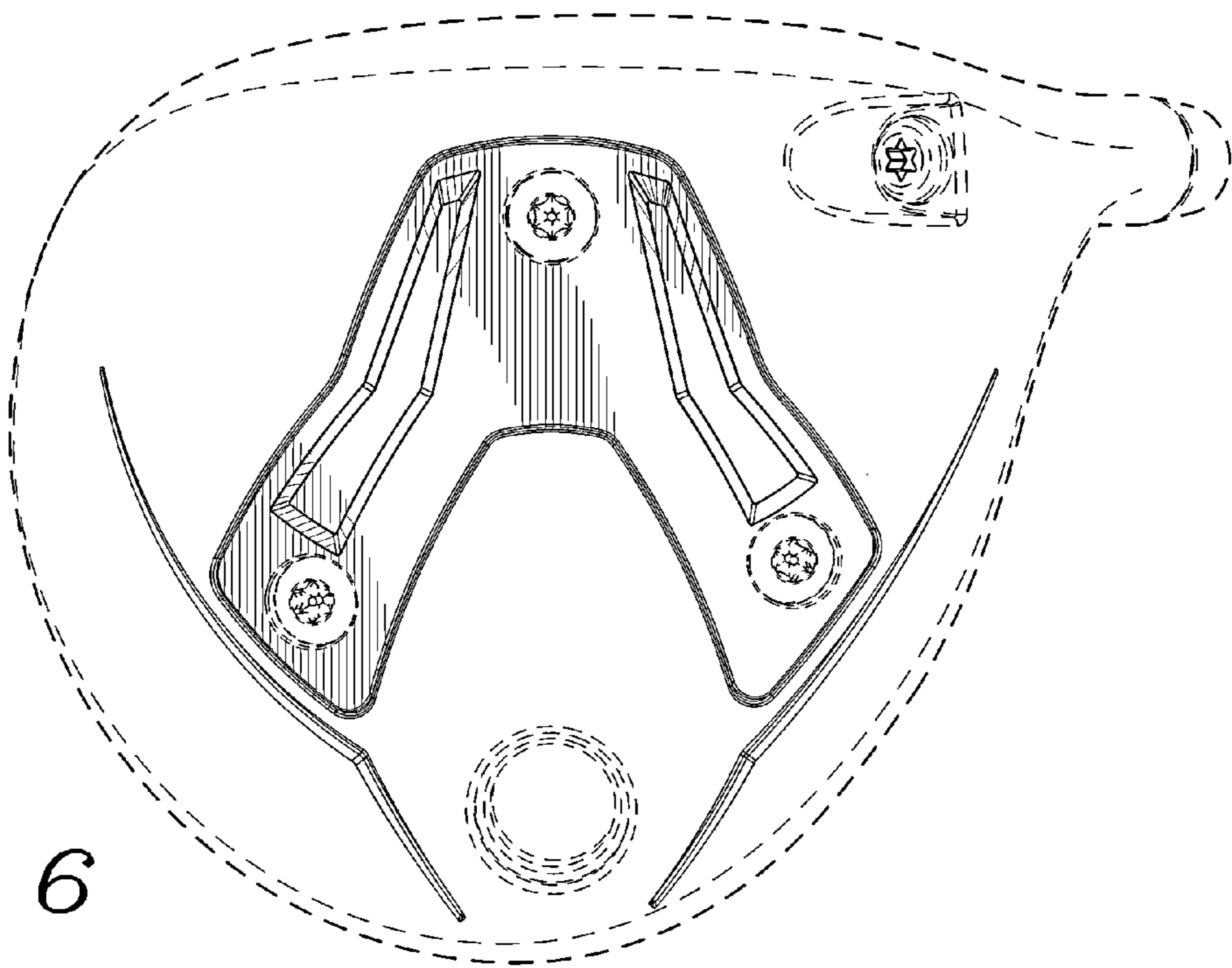
*Fig. 3*



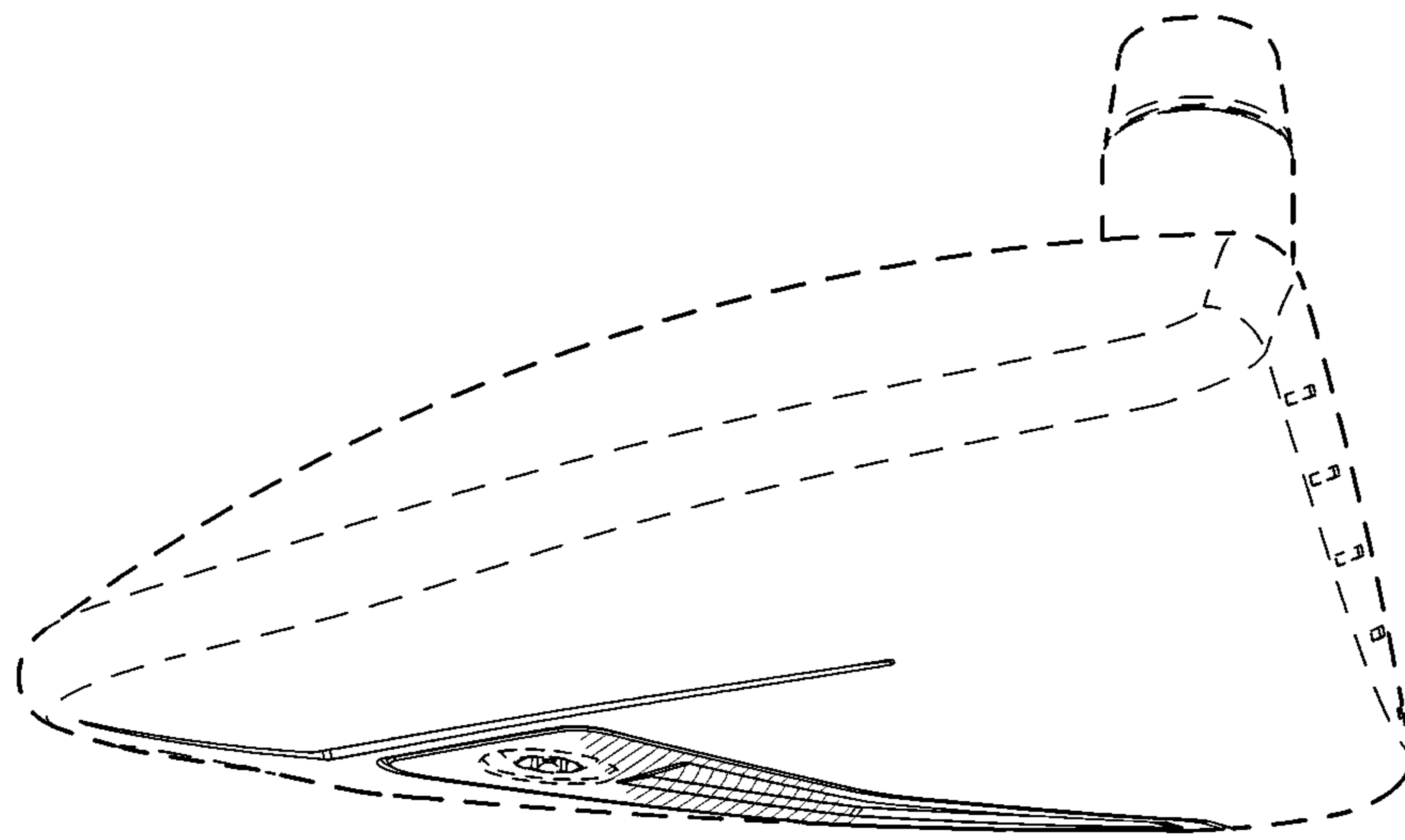
*Fig. 4*



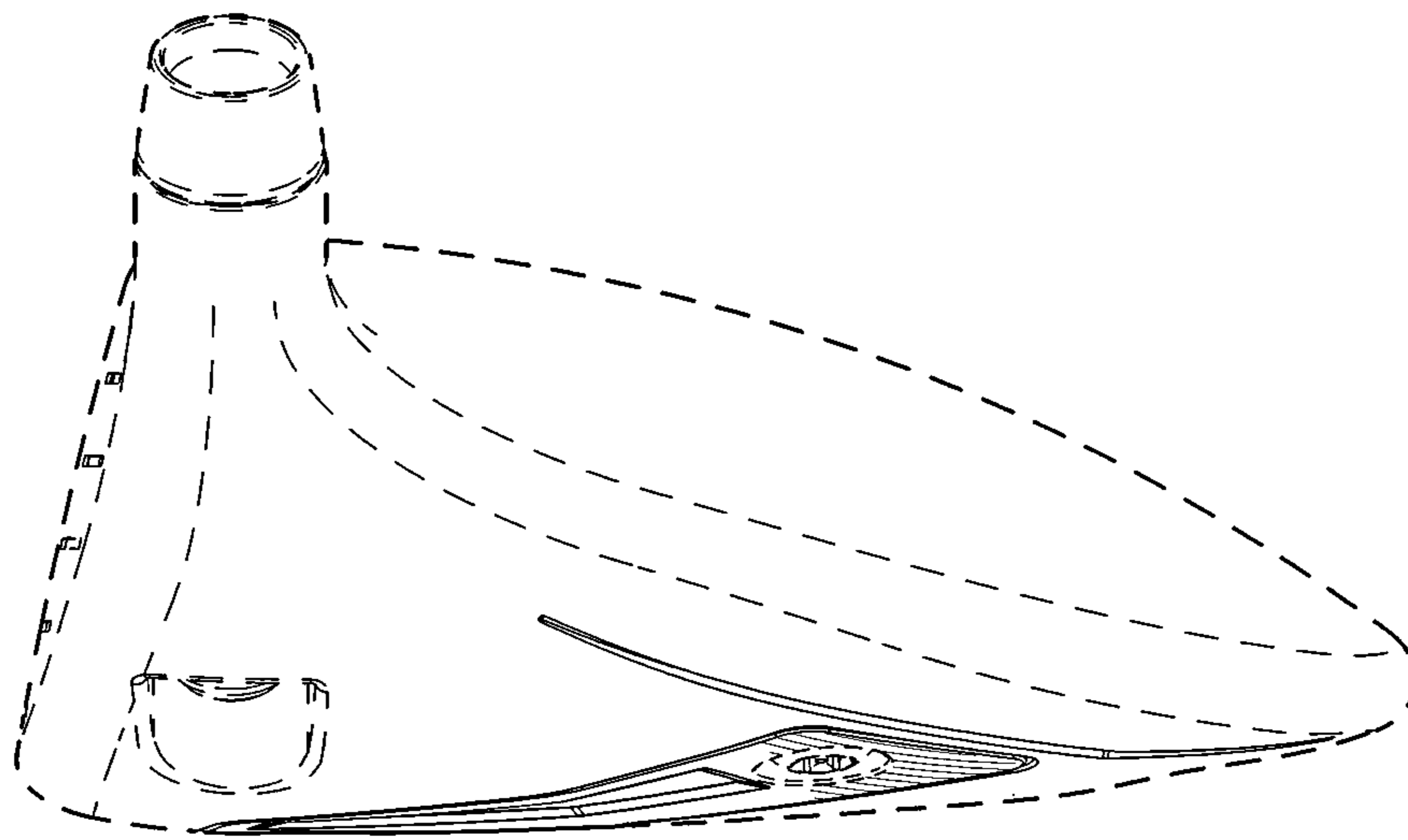
*Fig. 5*



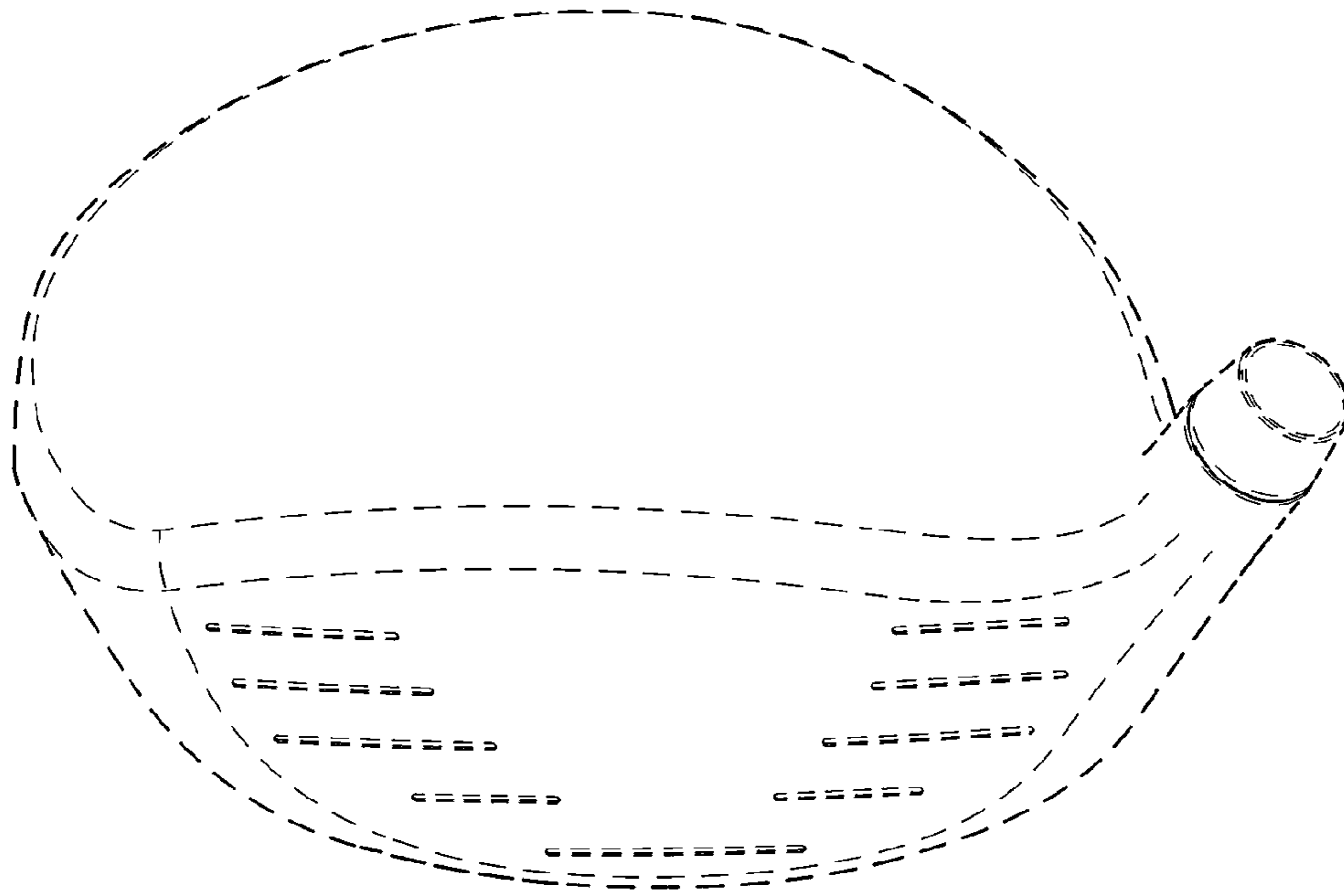
*Fig. 6*



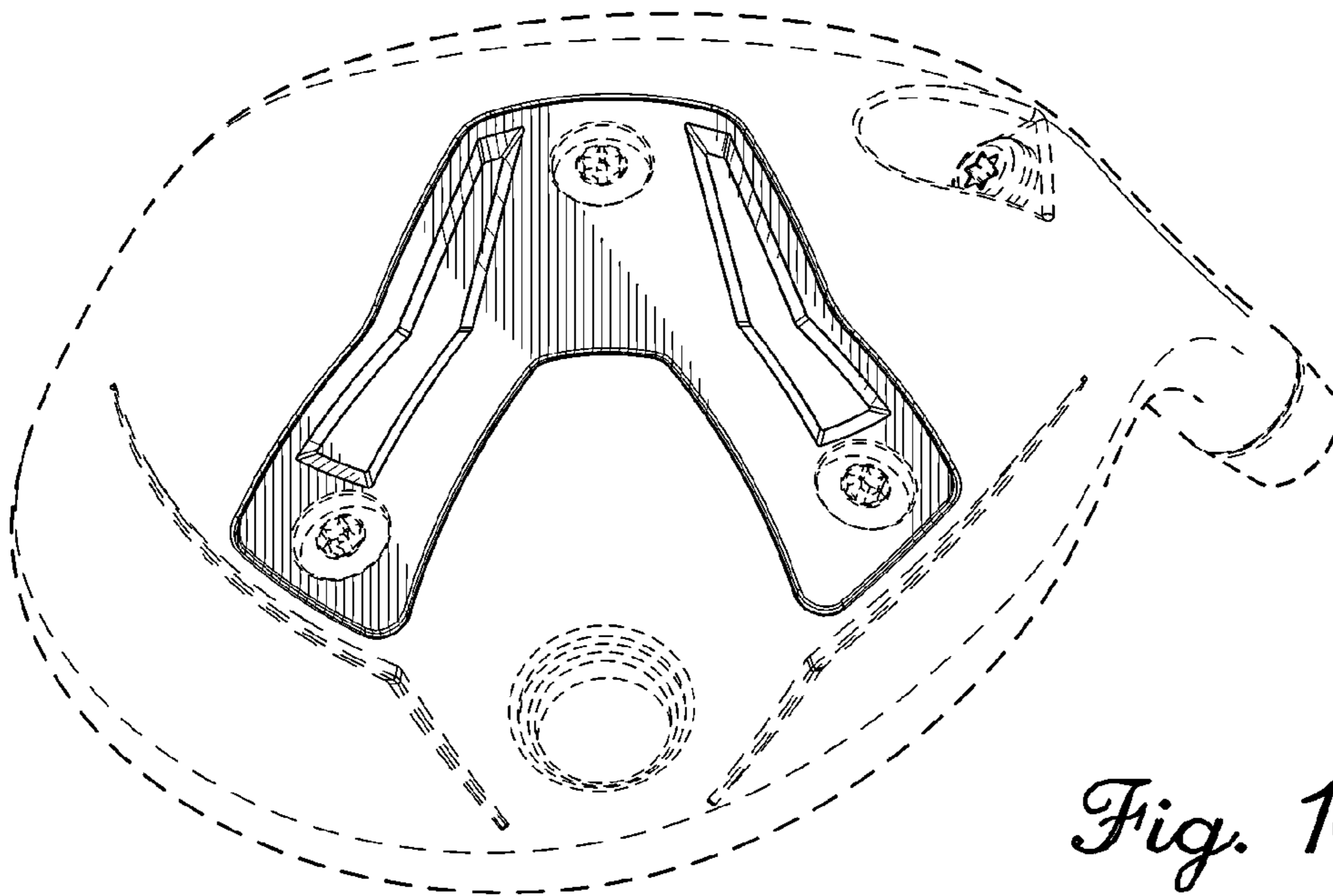
*Fig. 7*



*Fig. 8*

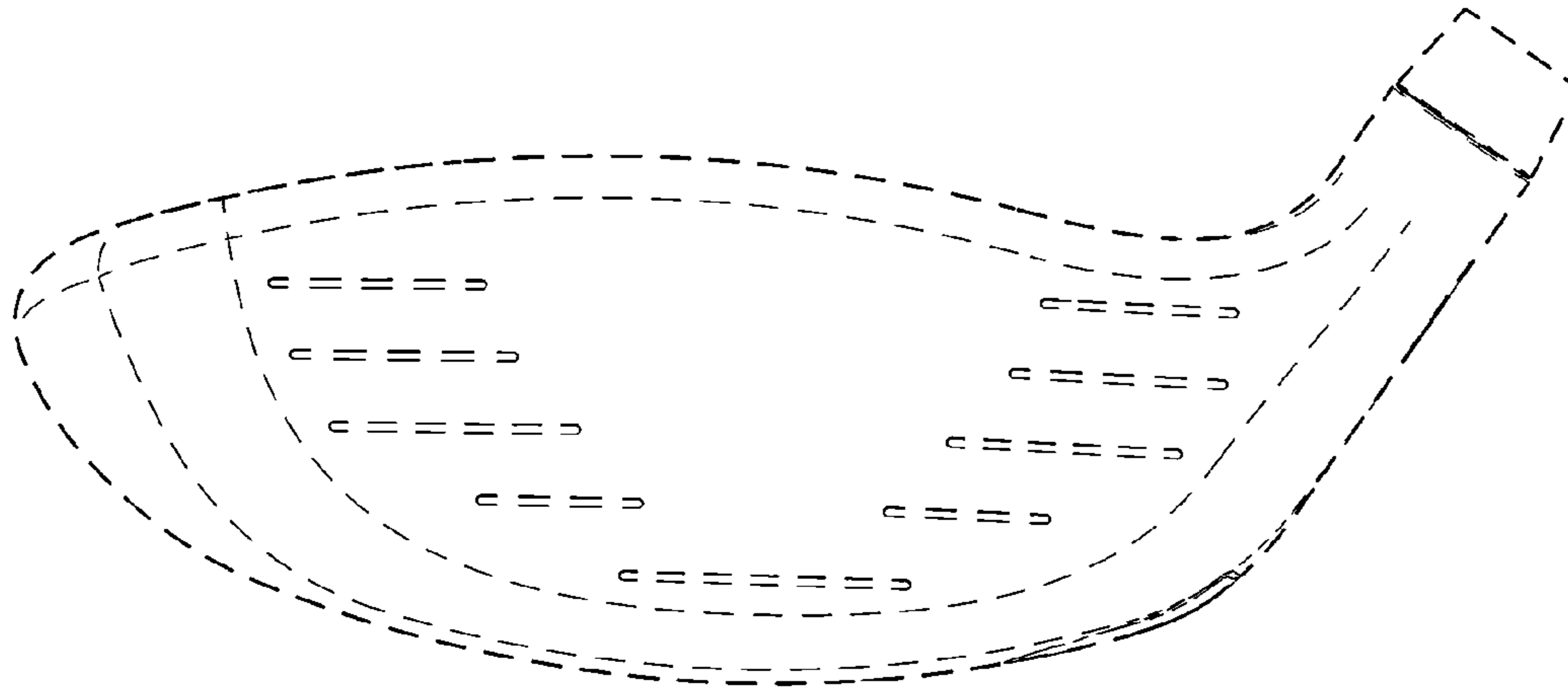


*Fig. 9*

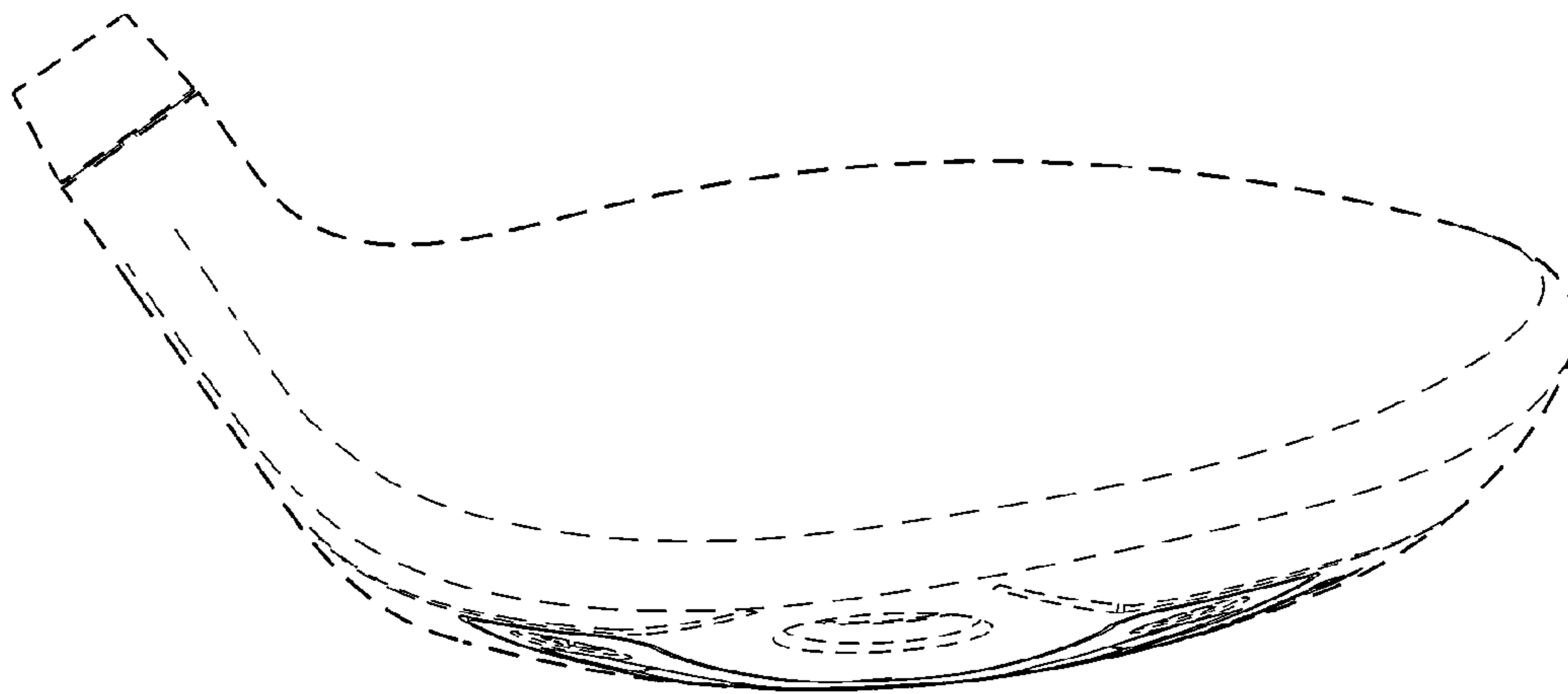


*Fig. 10*

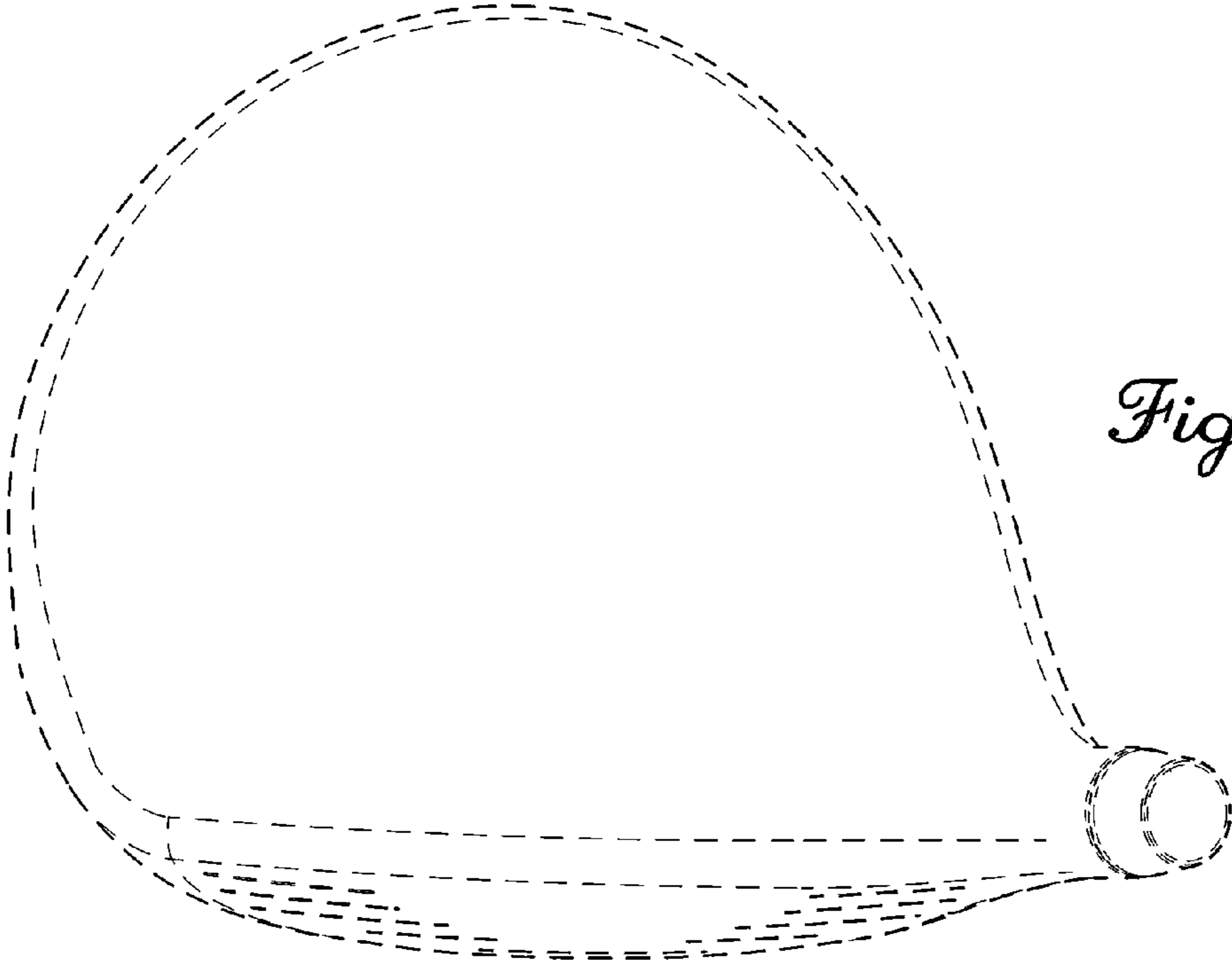




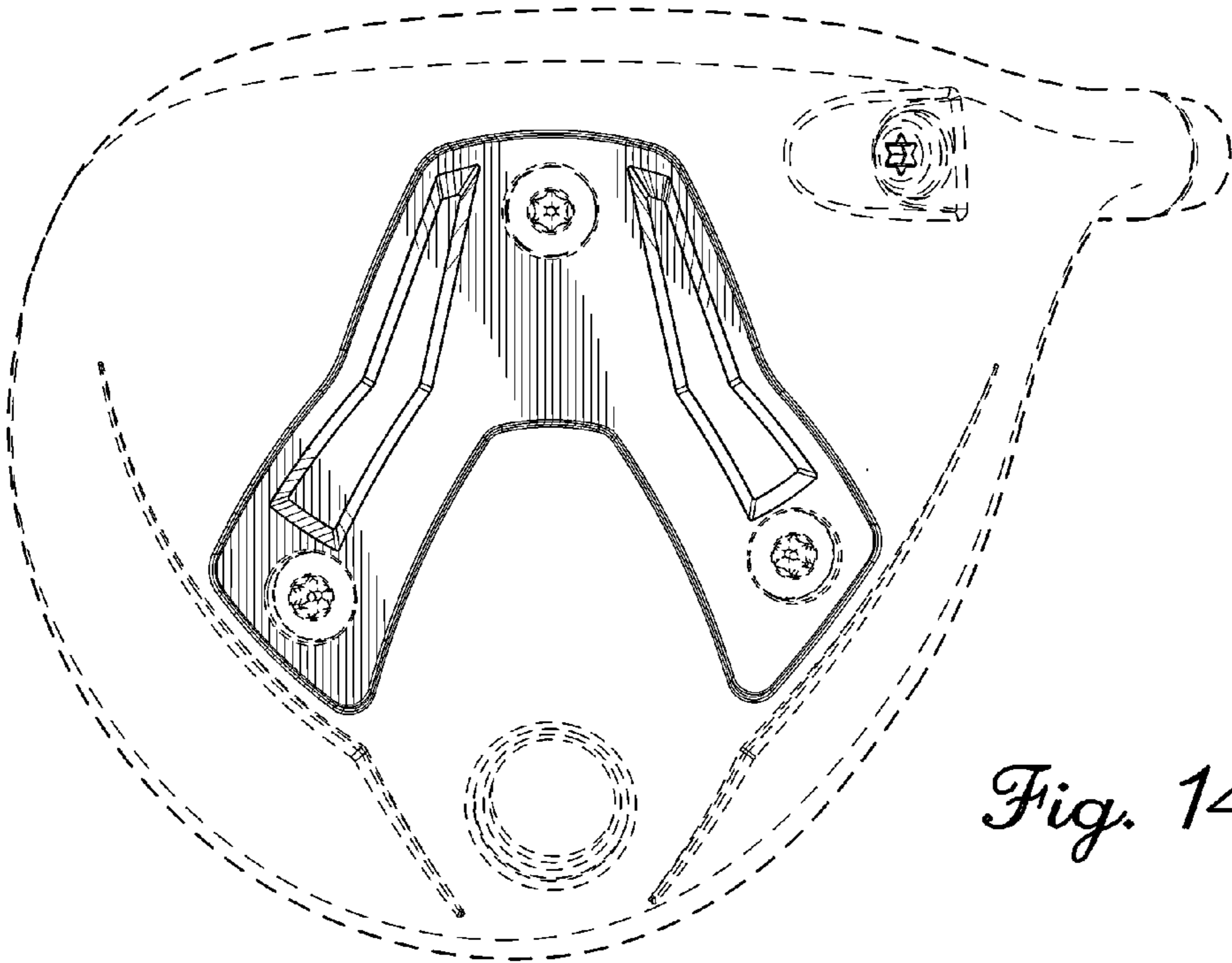
*Fig. 11*



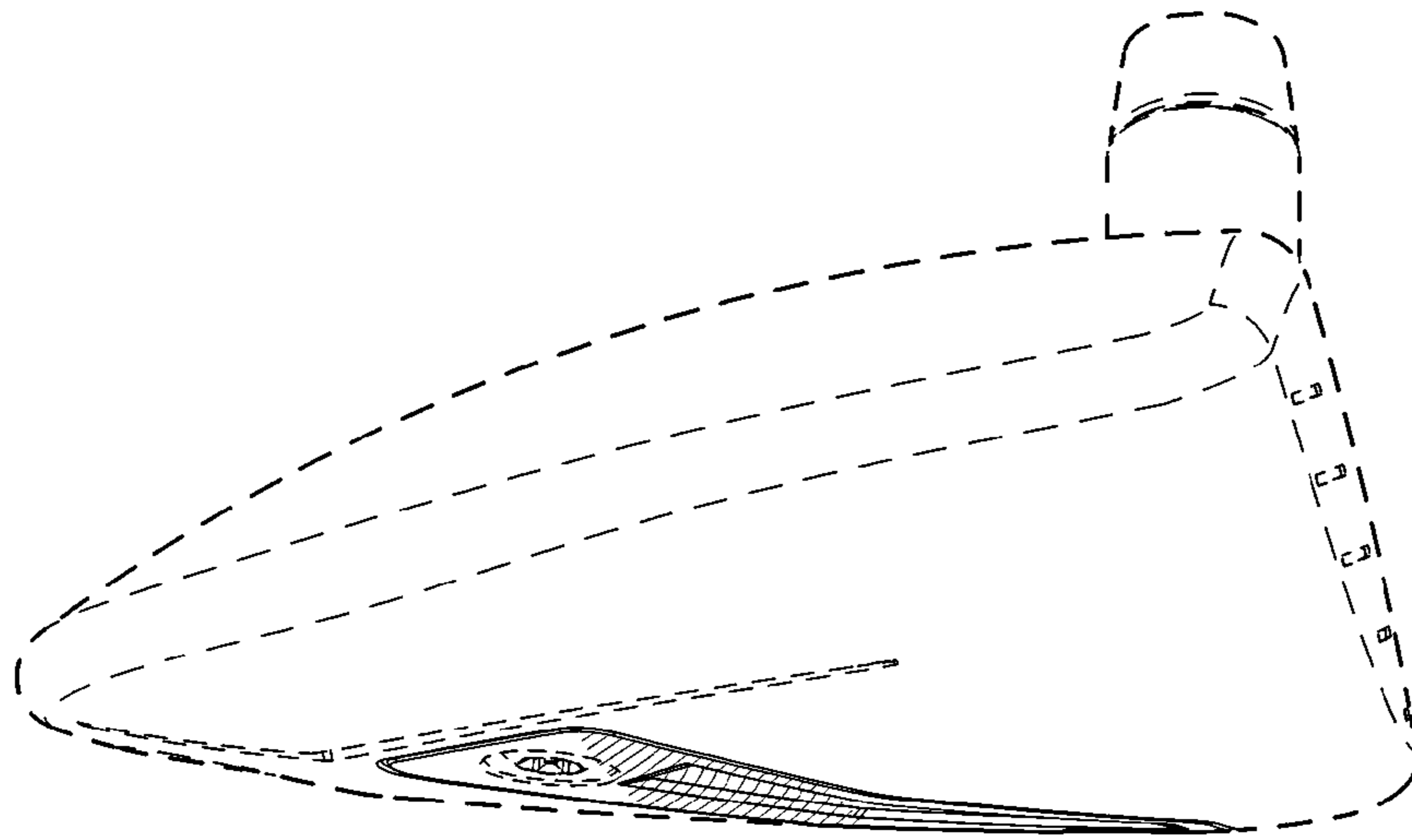
*Fig. 12*



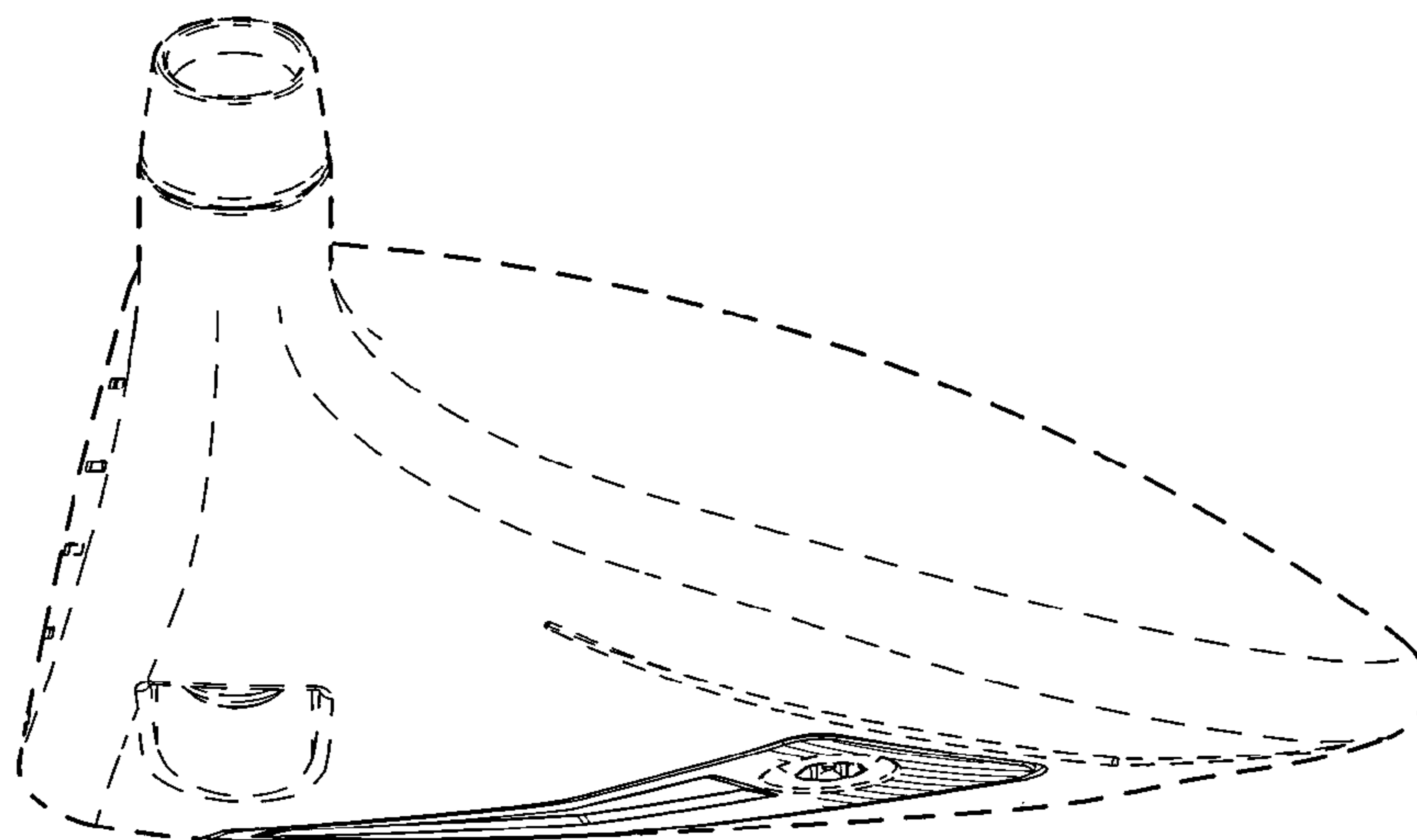
*Fig. 13*



*Fig. 14*



*Fig. 15*



*Fig. 16*