



US00D687500S

(12) **United States Design Patent**
Takahashi et al.

(10) **Patent No.:** **US D687,500 S**

(45) **Date of Patent:** **** Aug. 6, 2013**

(54) **TRANSFORMABLE TOY**

(75) Inventors: **Hideyuki Takahashi**, Tokyo (JP);
Takamichi Murayama, Tokyo (JP);
Kengo Nakanishi, Tokyo (JP); **Naomi**
Takebe, Tokyo (JP); **Kazuhiro Kikuchi**,
Tokyo (JP)

(73) Assignee: **Bandai Co., Ltd.**, Tokyo (JP)

(**) Term: **14 Years**

(21) Appl. No.: **29/422,739**

(22) Filed: **May 23, 2012**

(30) **Foreign Application Priority Data**

Nov. 23, 2011 (JP) 2011-027052

(51) **LOC (9) Cl.** **21-01**

(52) **U.S. Cl.**
USPC **D21/584**; D21/583

(58) **Field of Classification Search**
USPC D21/576–585; 446/72, 97, 268–269,
446/321, 356, 376, 487
See application file for complete search history.

(56) **References Cited**

U.S. PATENT DOCUMENTS

D294,605 S *	3/1988	Matsumoto	D21/583
D301,504 S *	6/1989	Kunihiro	D21/583
D307,778 S *	5/1990	Shinohara	D21/584
D483,816 S *	12/2003	Nakase	D21/578
D507,309 S *	7/2005	Nakase	D21/578
D507,310 S *	7/2005	Nakase	D21/578
D510,962 S *	10/2005	Nakase	D21/578

8,187,049 B2 * 5/2012 Corsiglia et al. 446/376
D674,029 S * 1/2013 Takahashi et al. D21/579

* cited by examiner

Primary Examiner — Sandra Morris
(74) *Attorney, Agent, or Firm* — Rabin & Berdo, P.C.

(57) **CLAIM**

The ornamental design for a transformable toy, as shown and described.

DESCRIPTION

FIG. 1 is a front view of a transformable toy;
FIG. 2 is a rear view thereof;
FIG. 3 is a right side view thereof;
FIG. 4 is a left side view thereof;
FIG. 5 is a top view thereof;
FIG. 6 is a bottom view thereof;
FIG. 7 is a perspective view thereof;
FIG. 8 is another perspective view thereof;
FIG. 9 is a front view of the vehicle form thereof;
FIG. 10 is a rear view of the vehicle form thereof;
FIG. 11 is a right side view of the vehicle form thereof;
FIG. 12 is a left side view for vehicle form thereof;
FIG. 13 is a top view of the vehicle form thereof;
FIG. 14 is a bottom view of the vehicle form thereof;
FIG. 15 is a perspective view of the vehicle form thereof;
FIG. 16 is another perspective view of the vehicle form thereof;
FIG. 17 is a reference view of the detachable mode thereof;
and,
FIG. 18 is another reference view of the detachable mode thereof.
This product can reversibly change into an animal and vehicle forms.

1 Claim, 18 Drawing Sheets

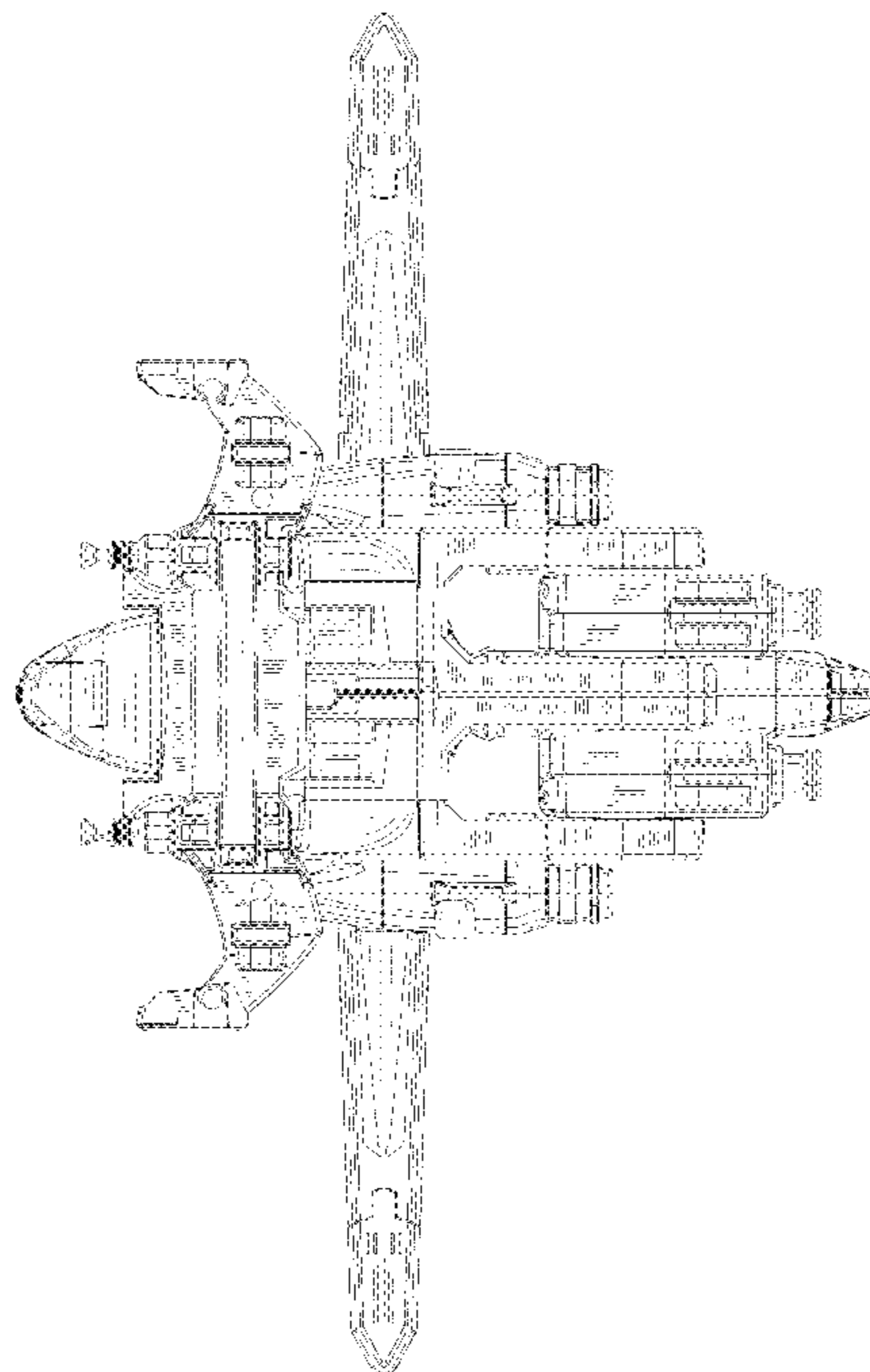
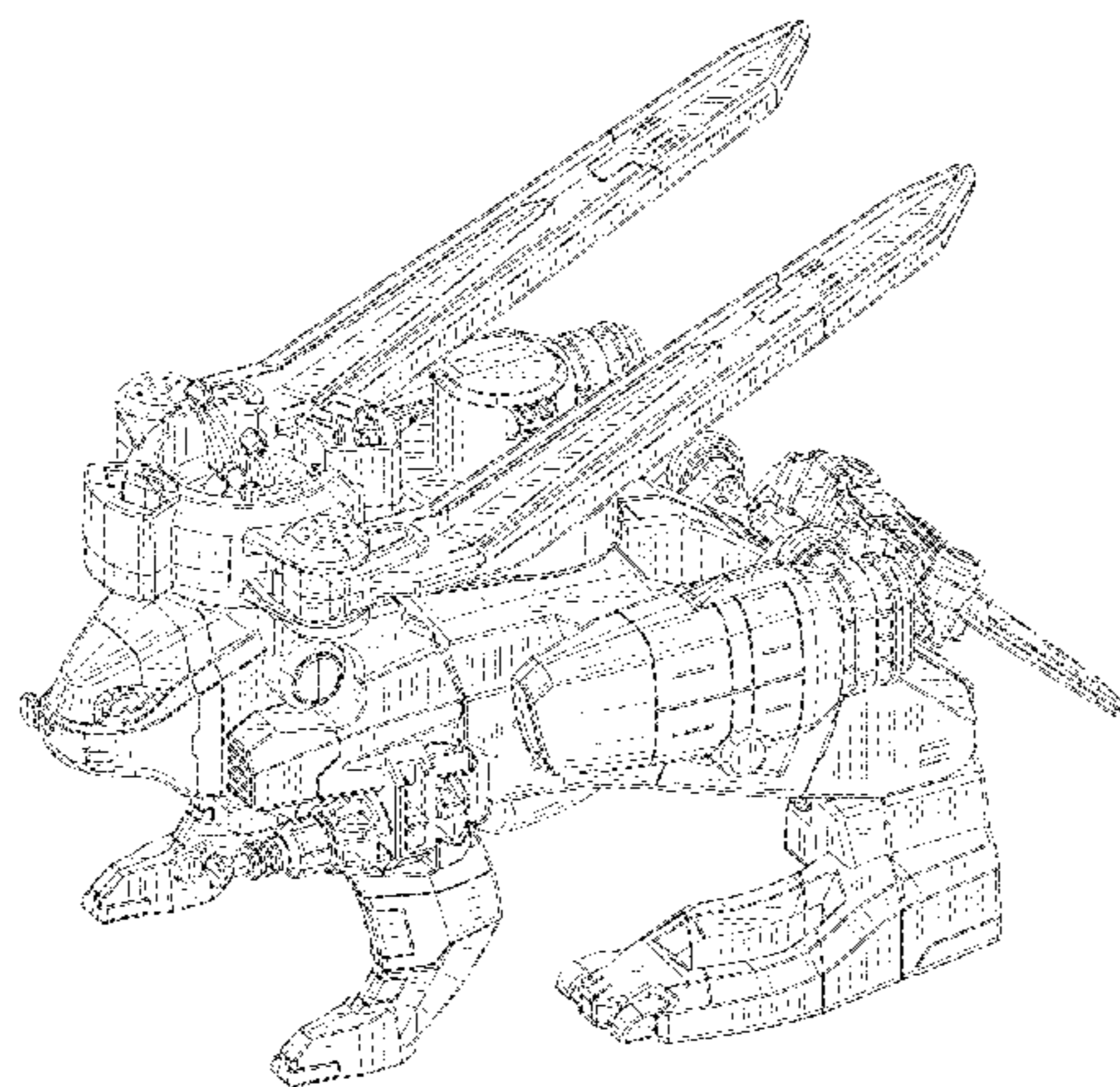

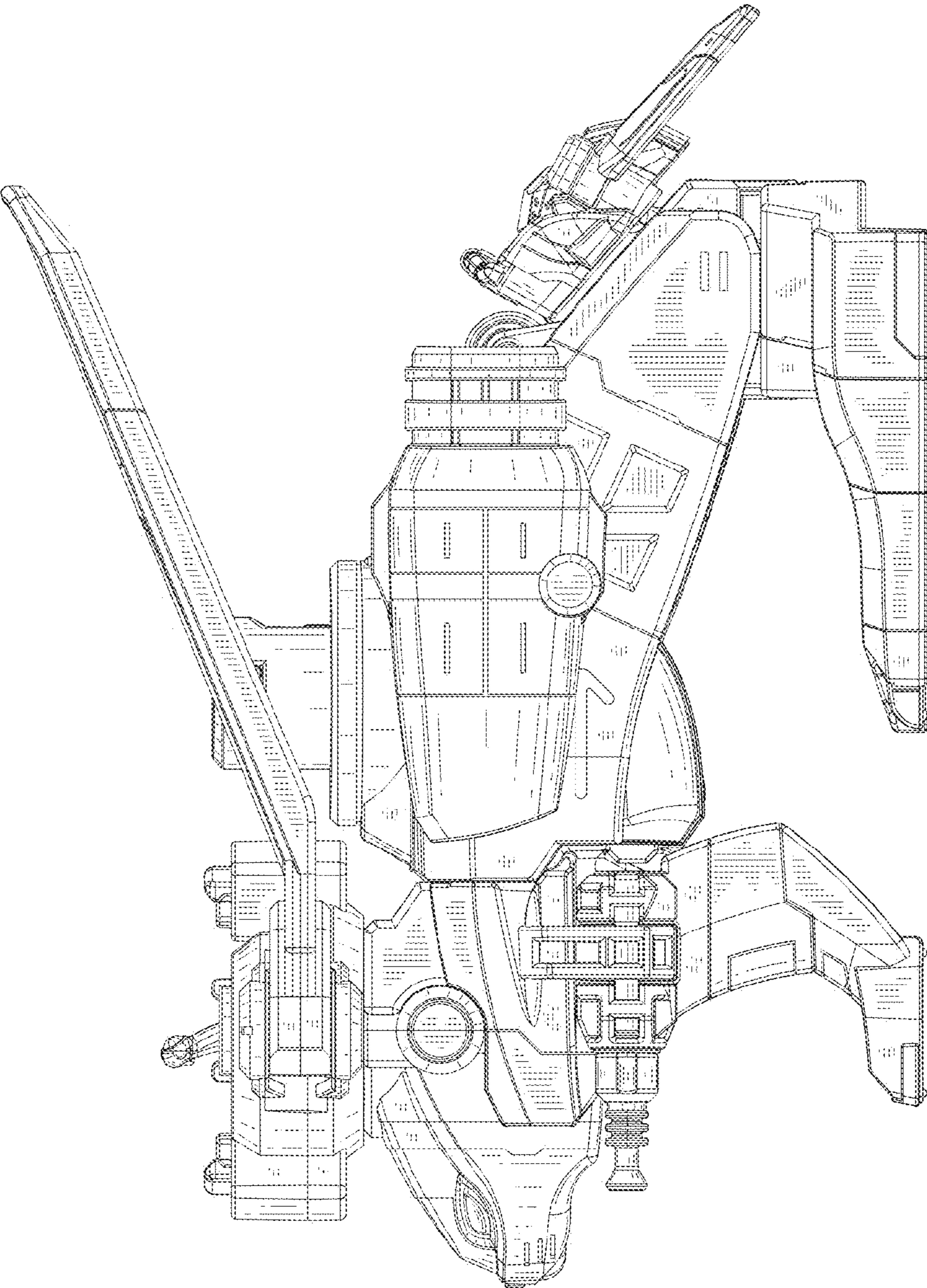

FIG. 1

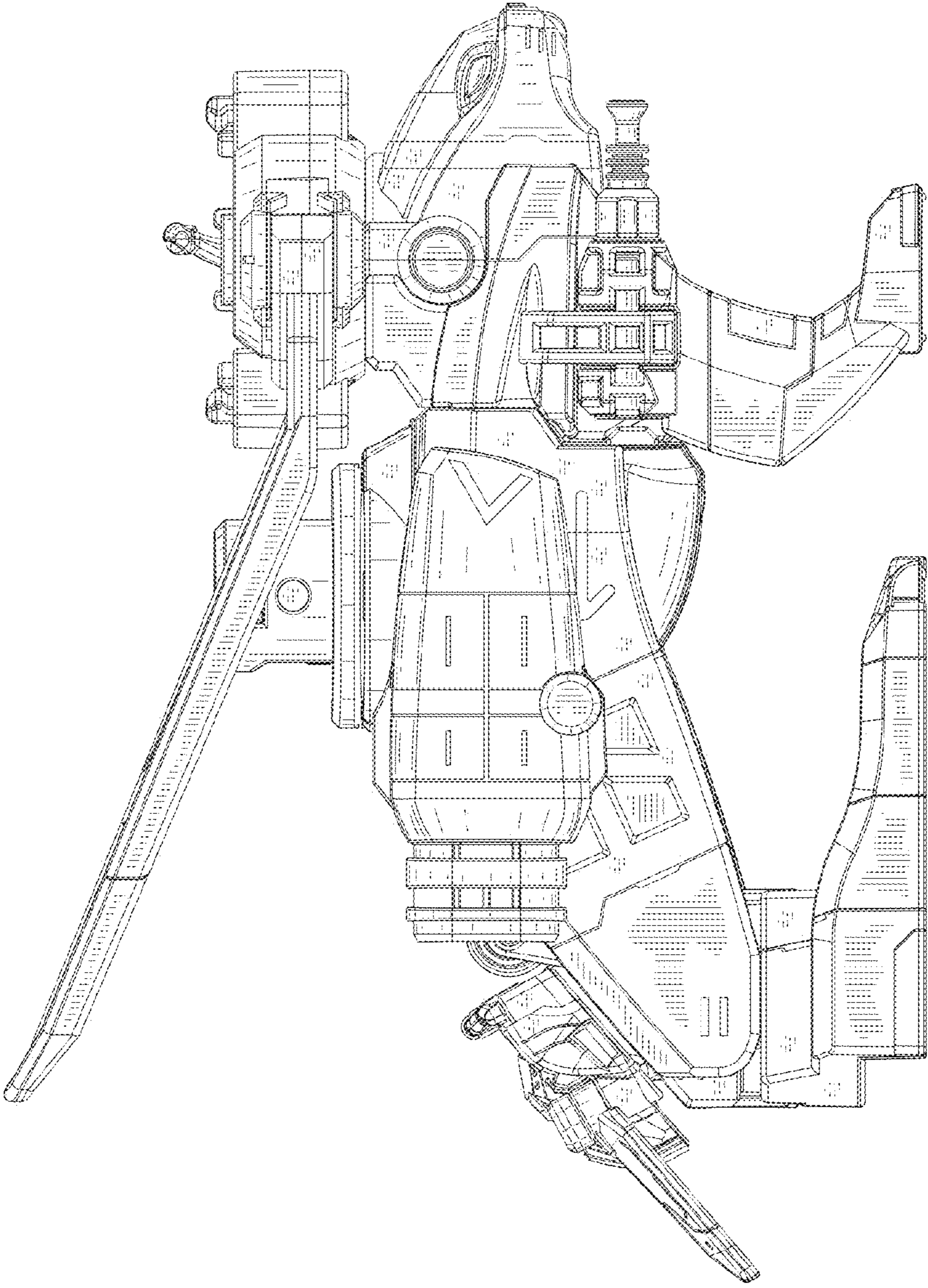

FIG. 2

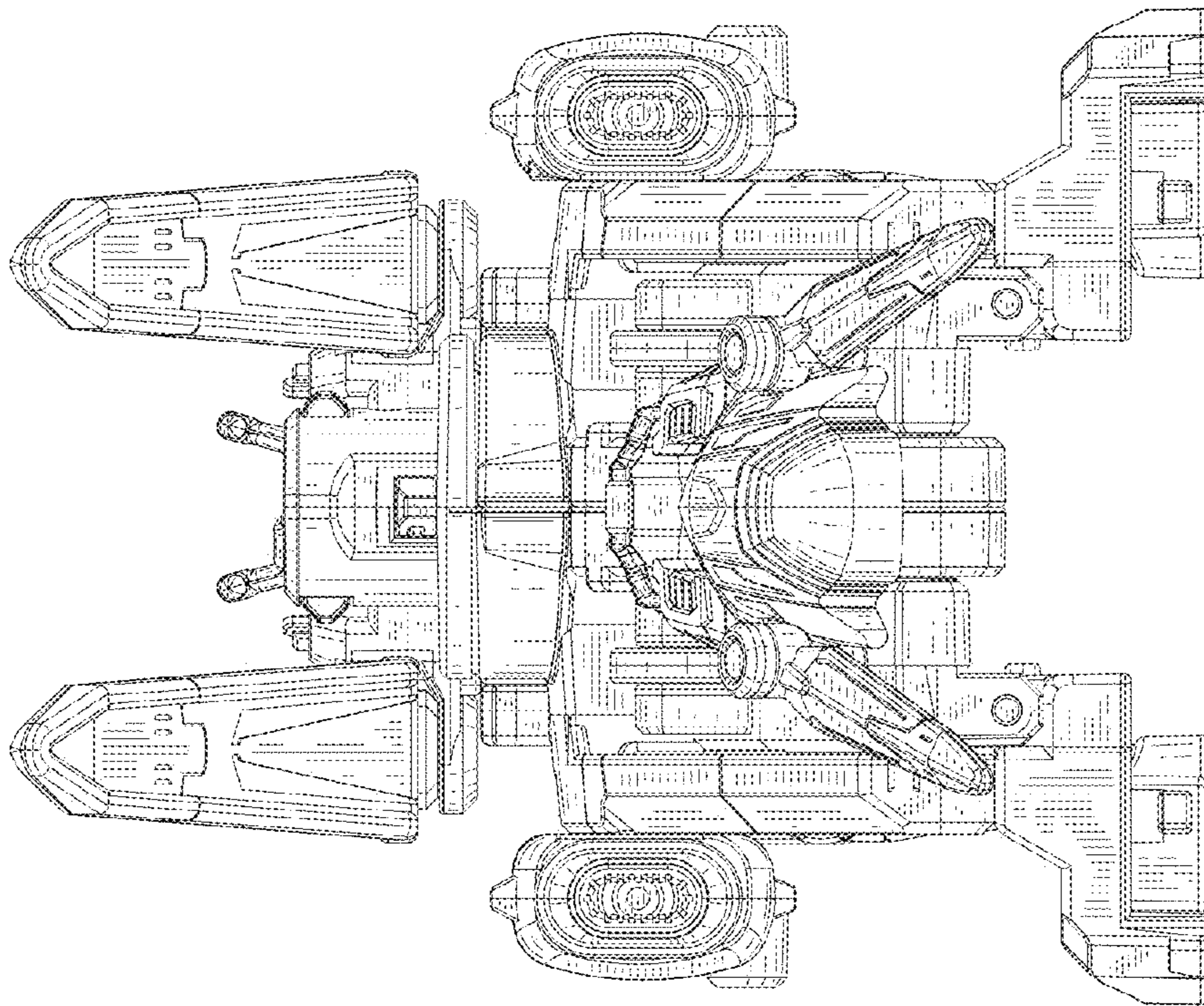

FIG. 3

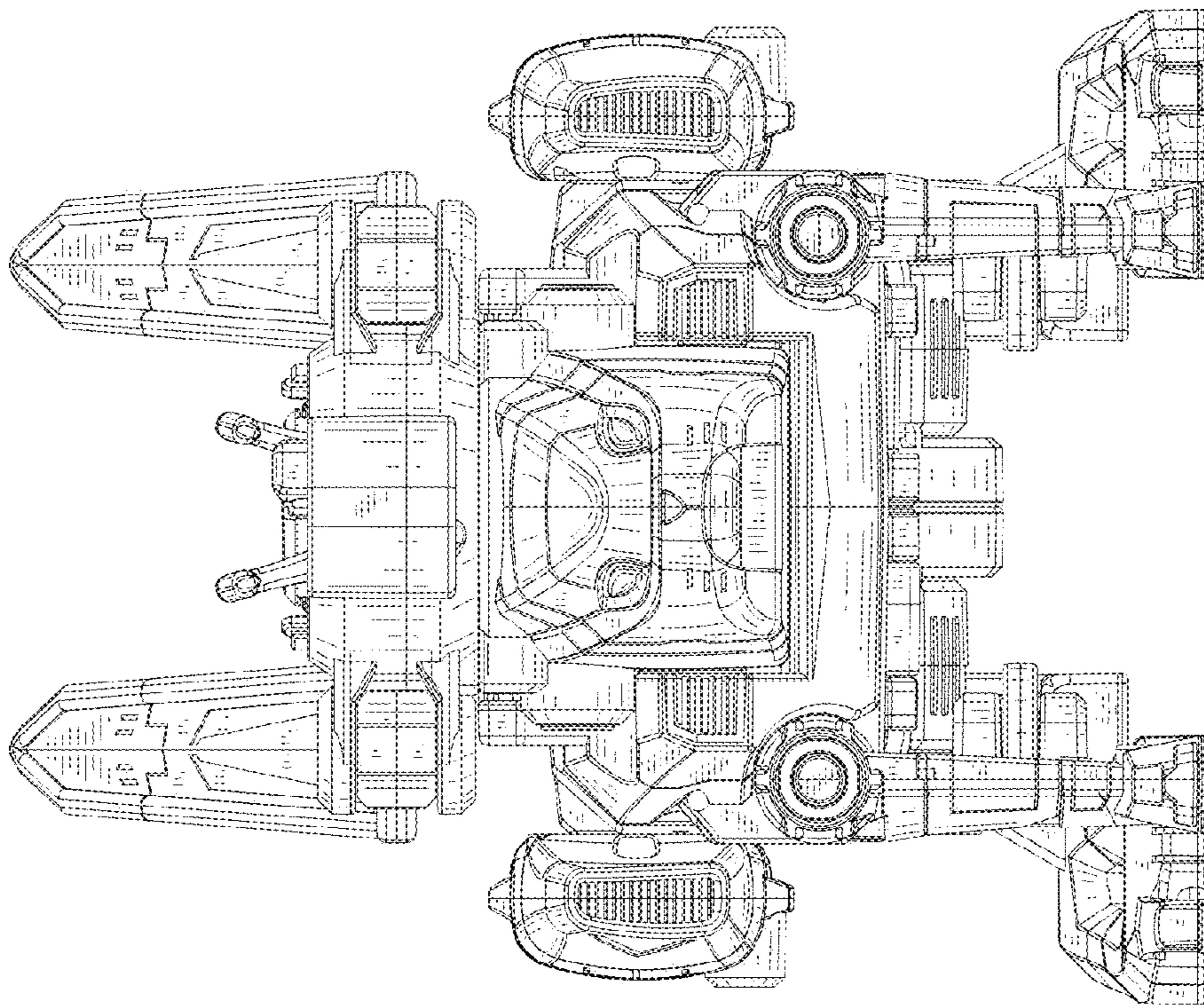

FIG. 4

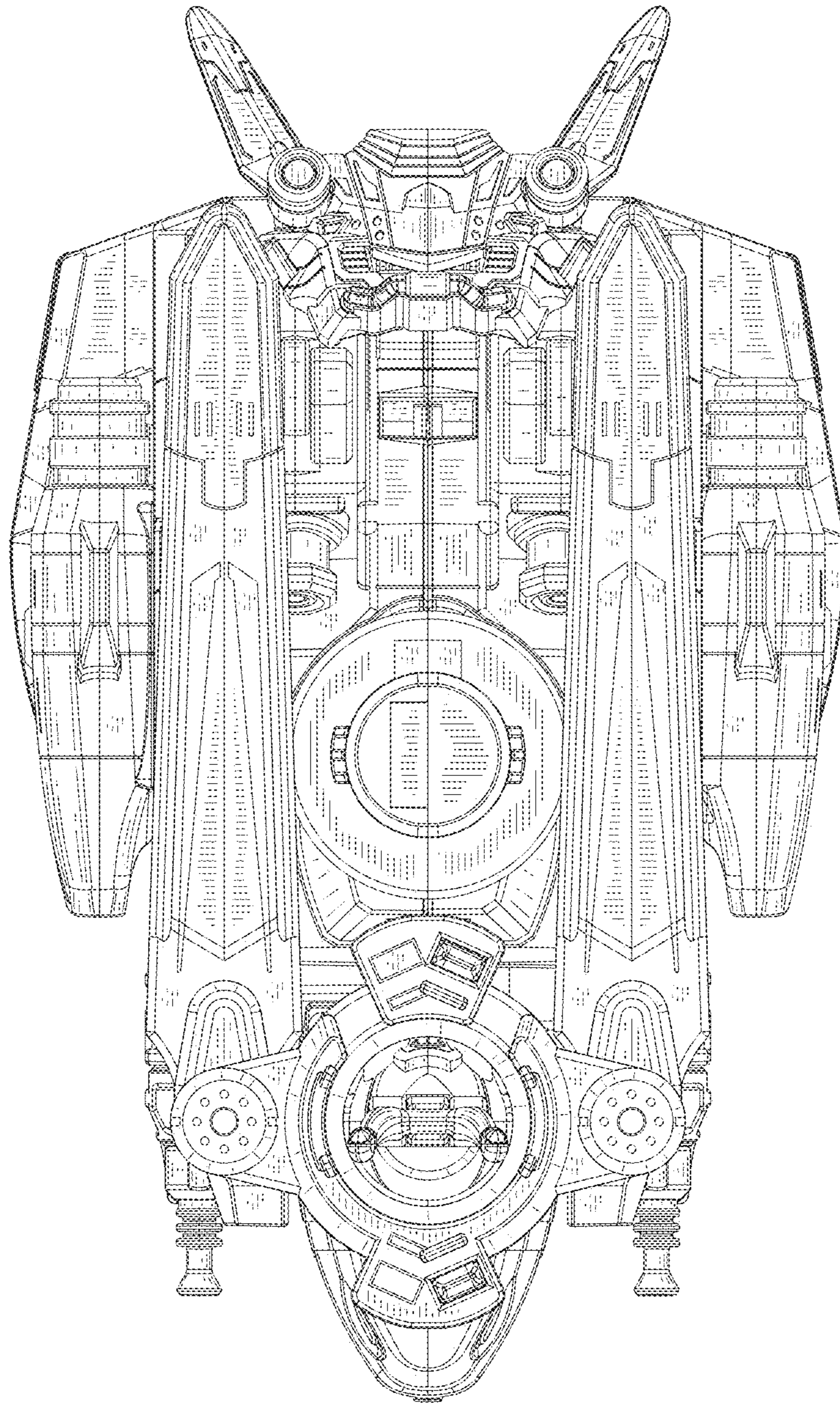

FIG. 5

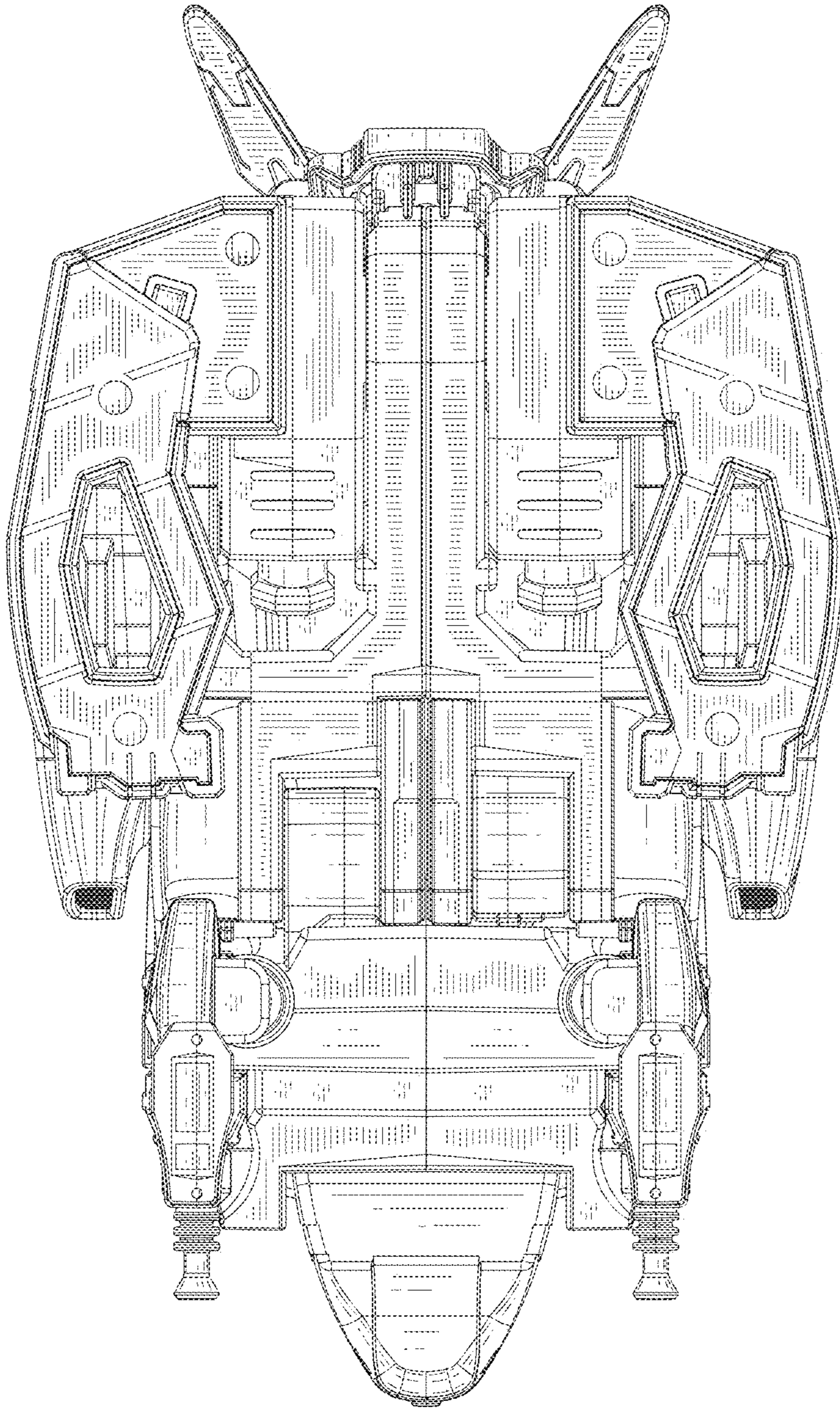

FIG. 6

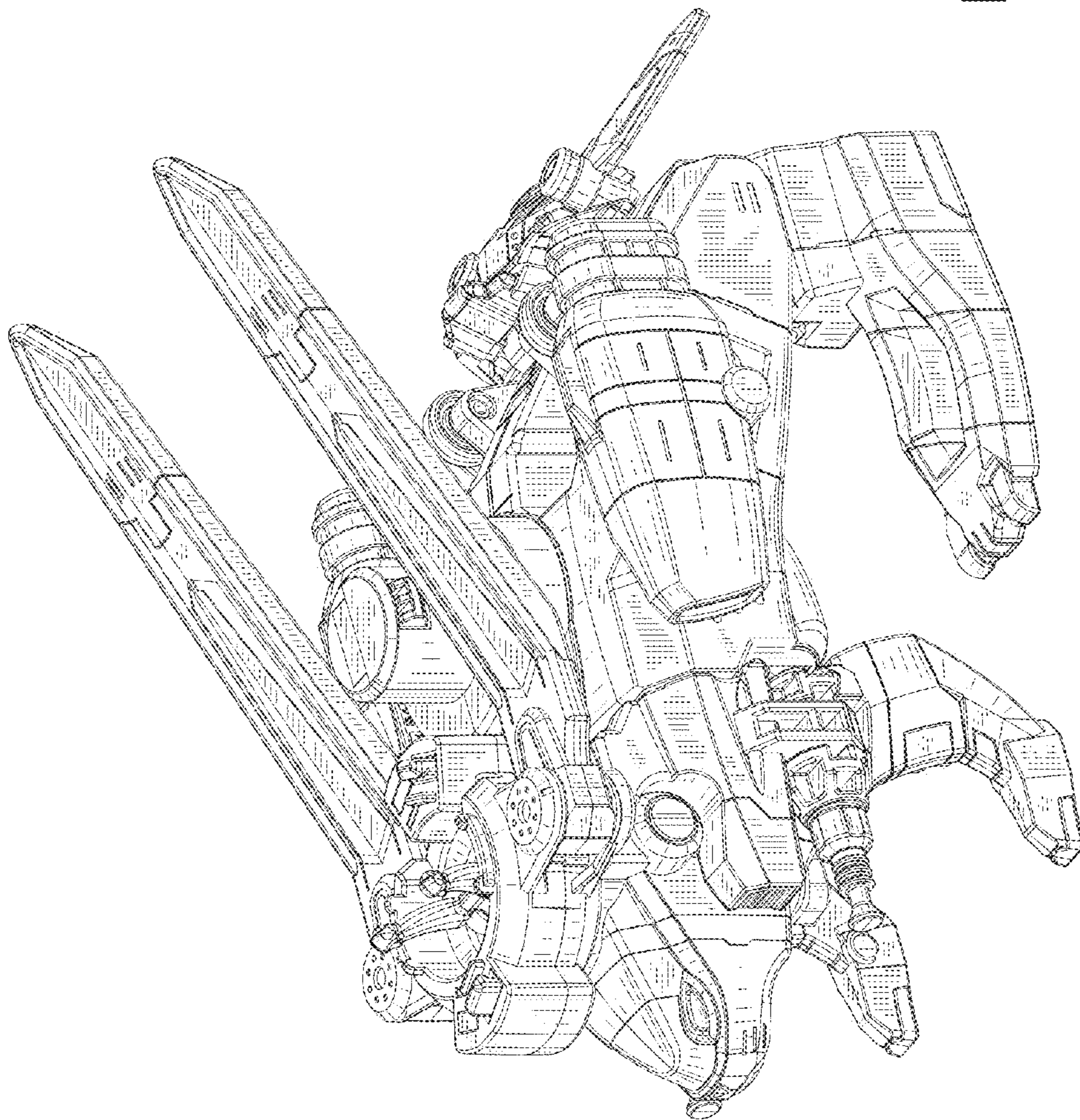

FIG. 7

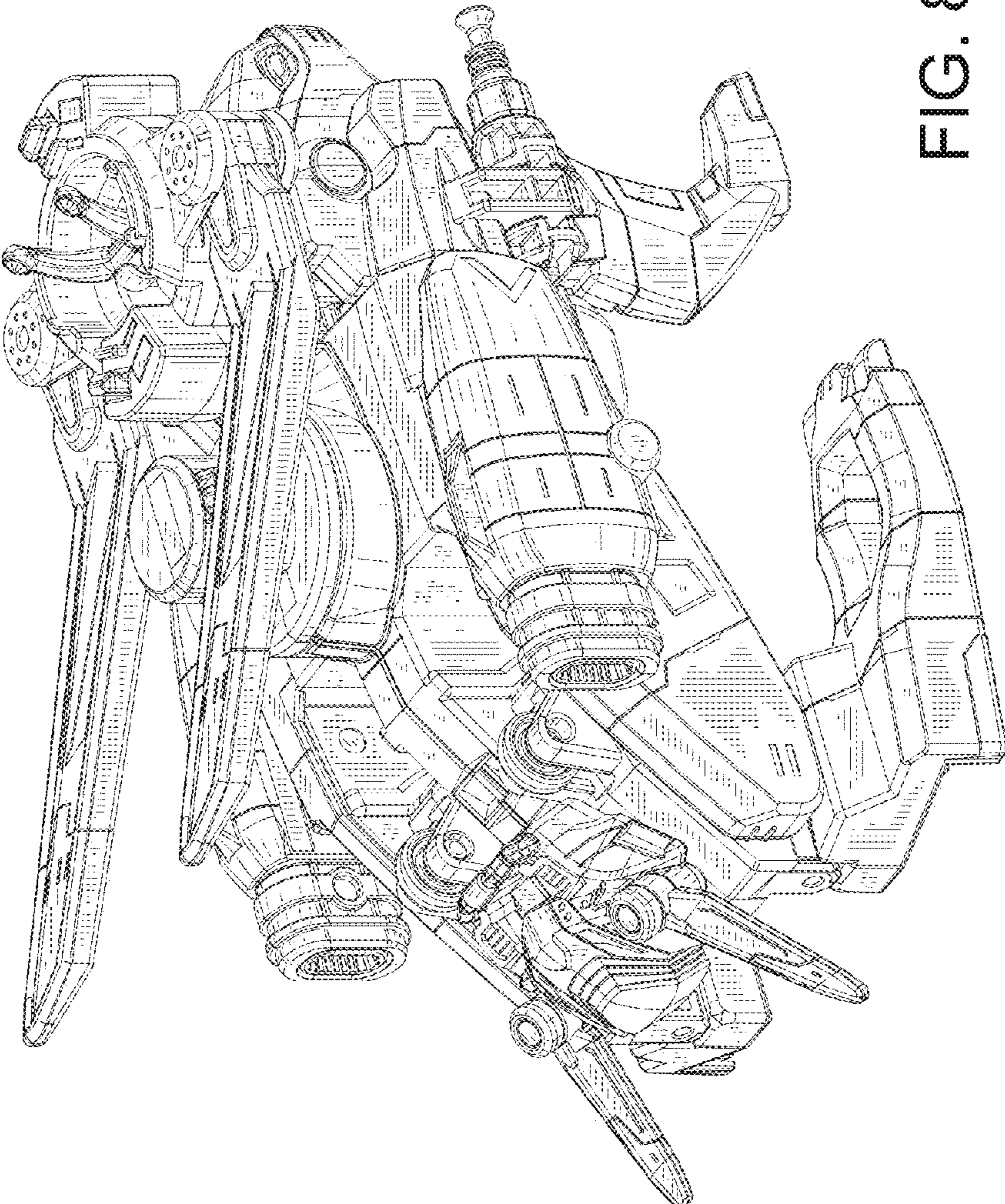

FIG. 8

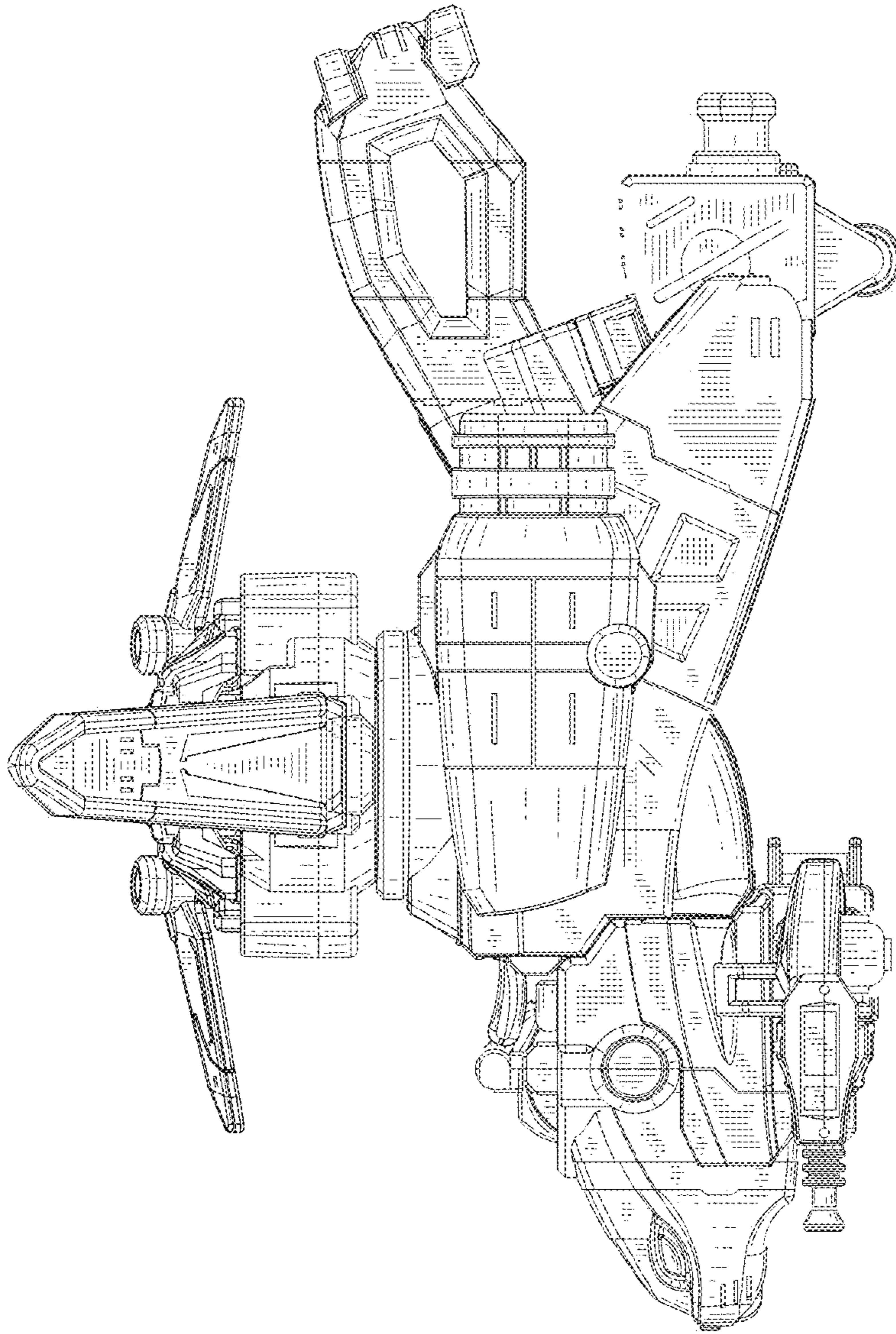

FIG. 9

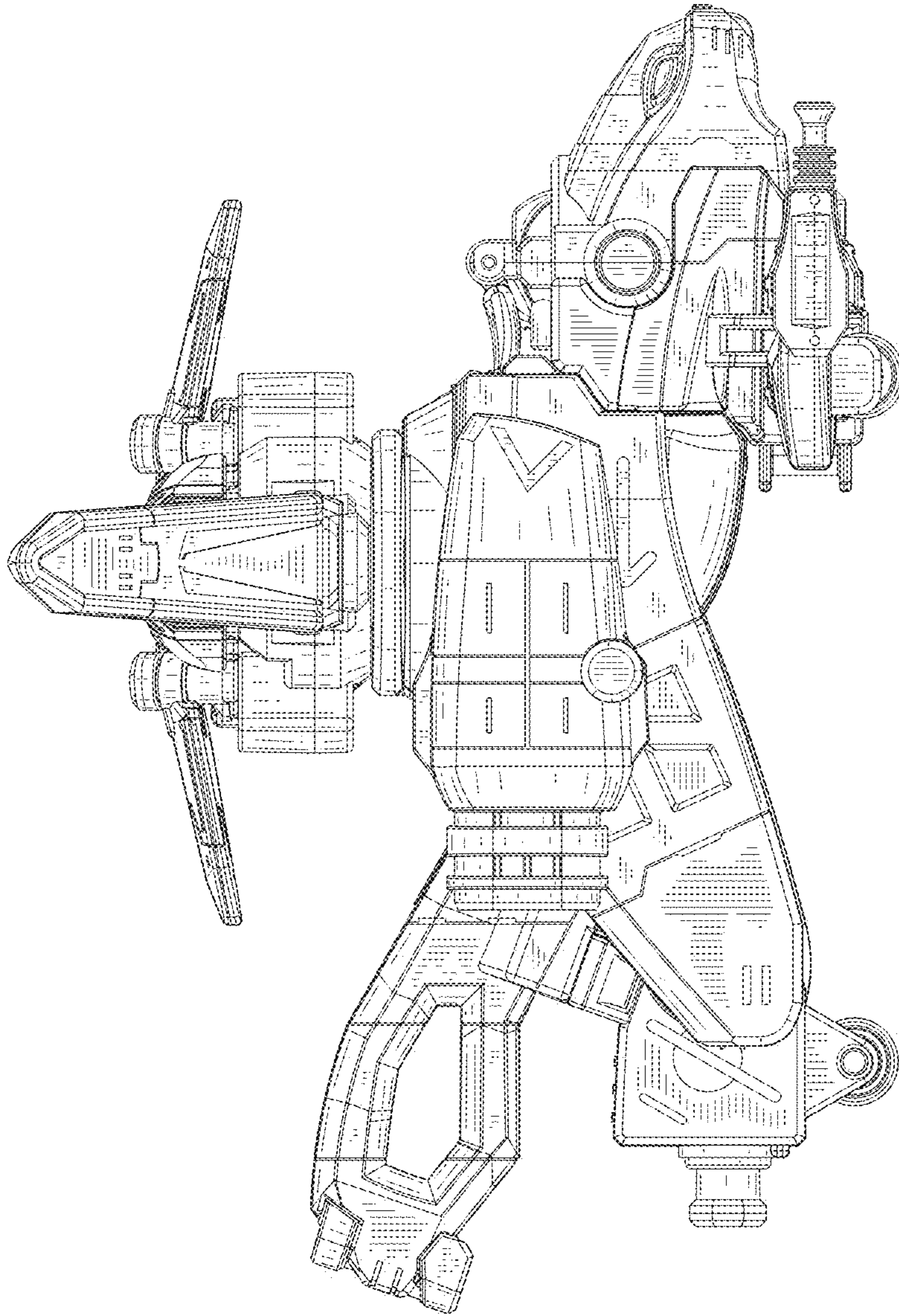

FIG. 10

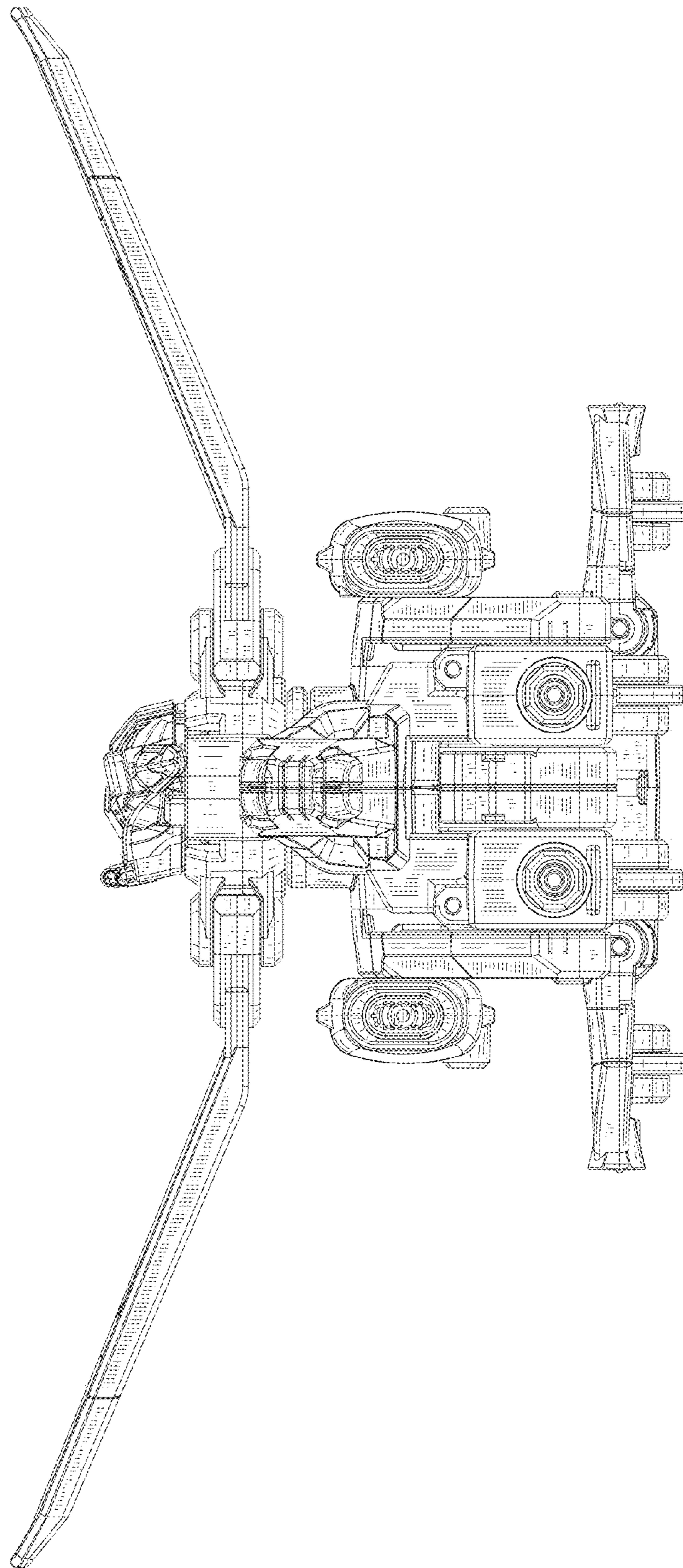

FIG. 11

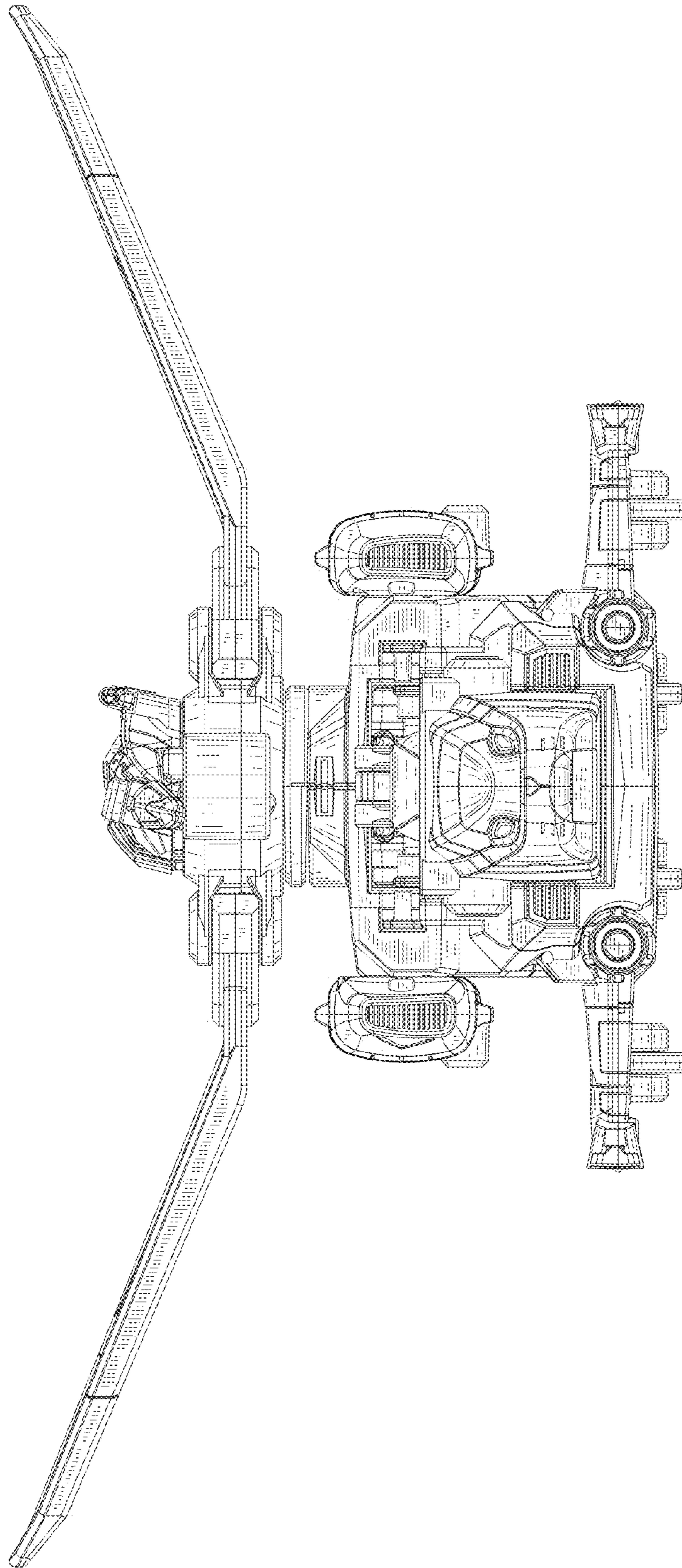

FIG. 12

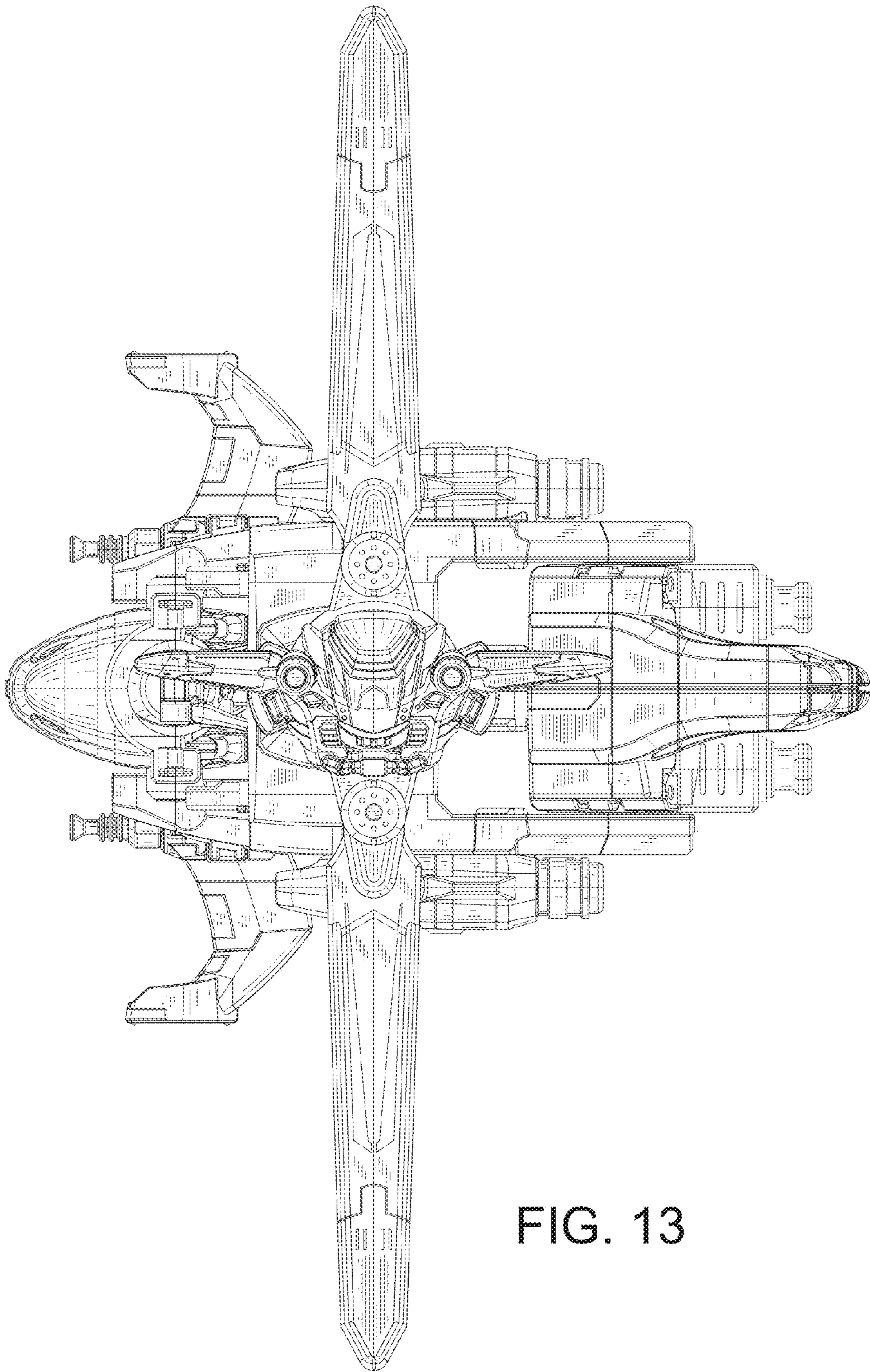

FIG. 13

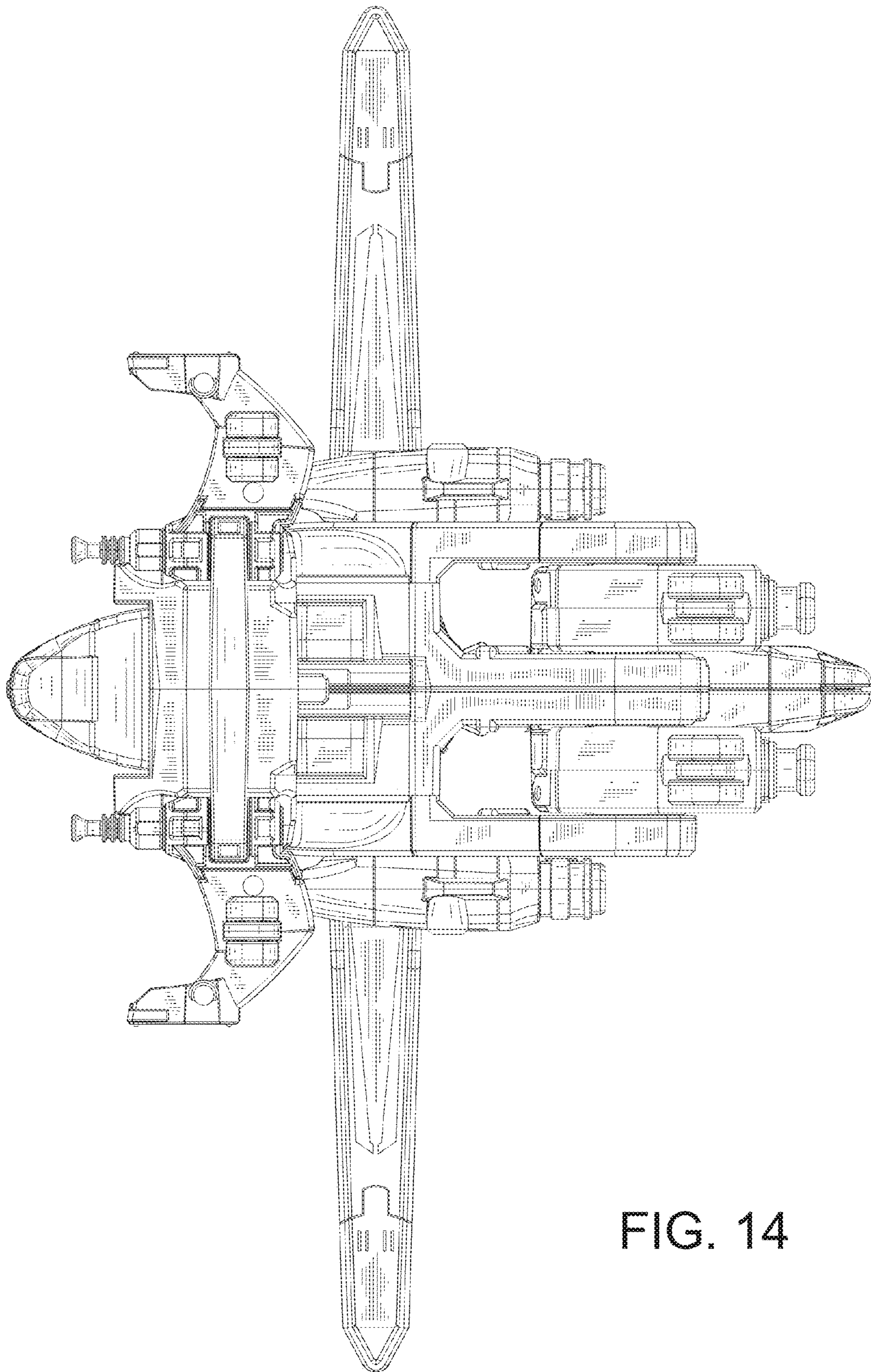

FIG. 14

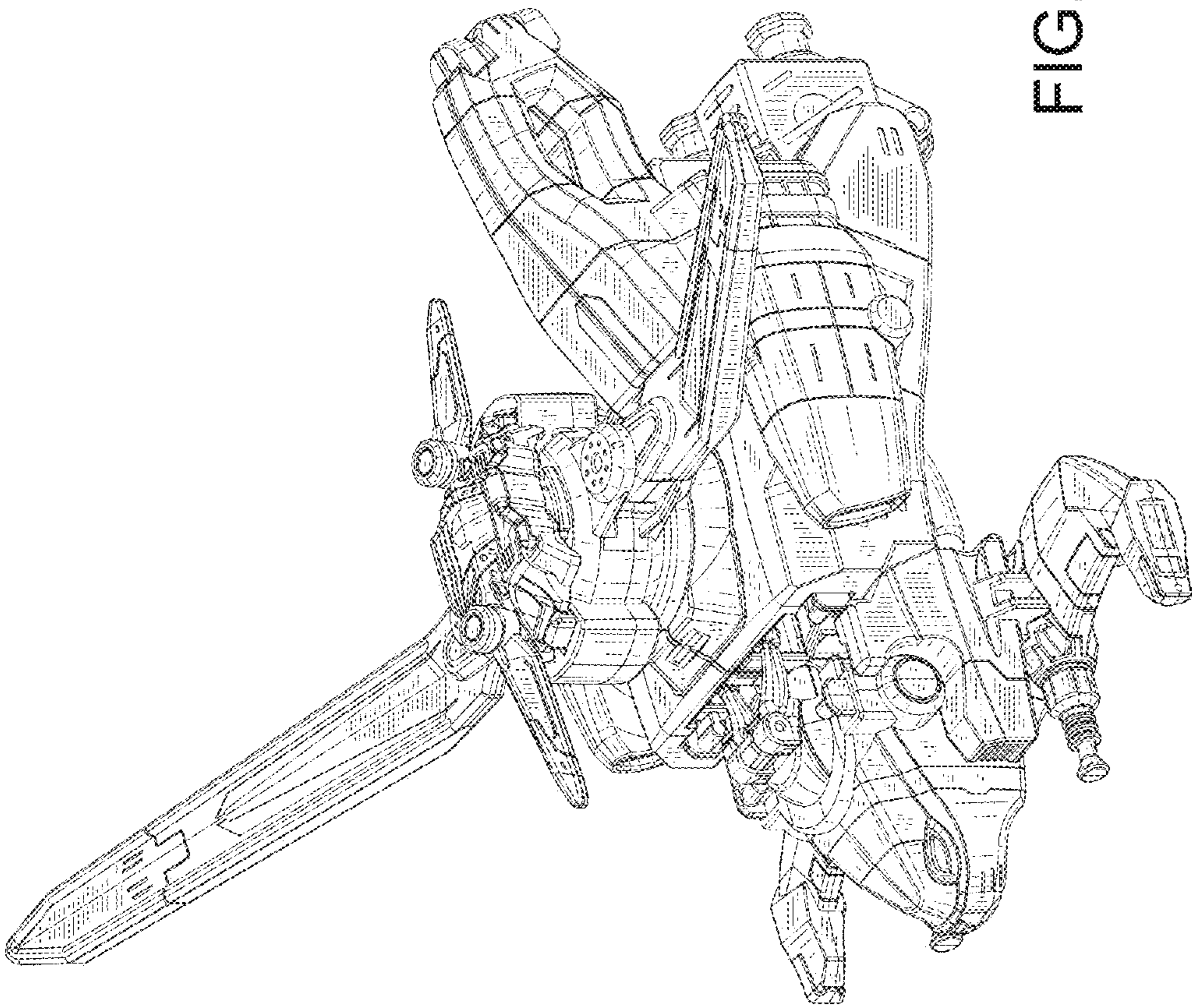
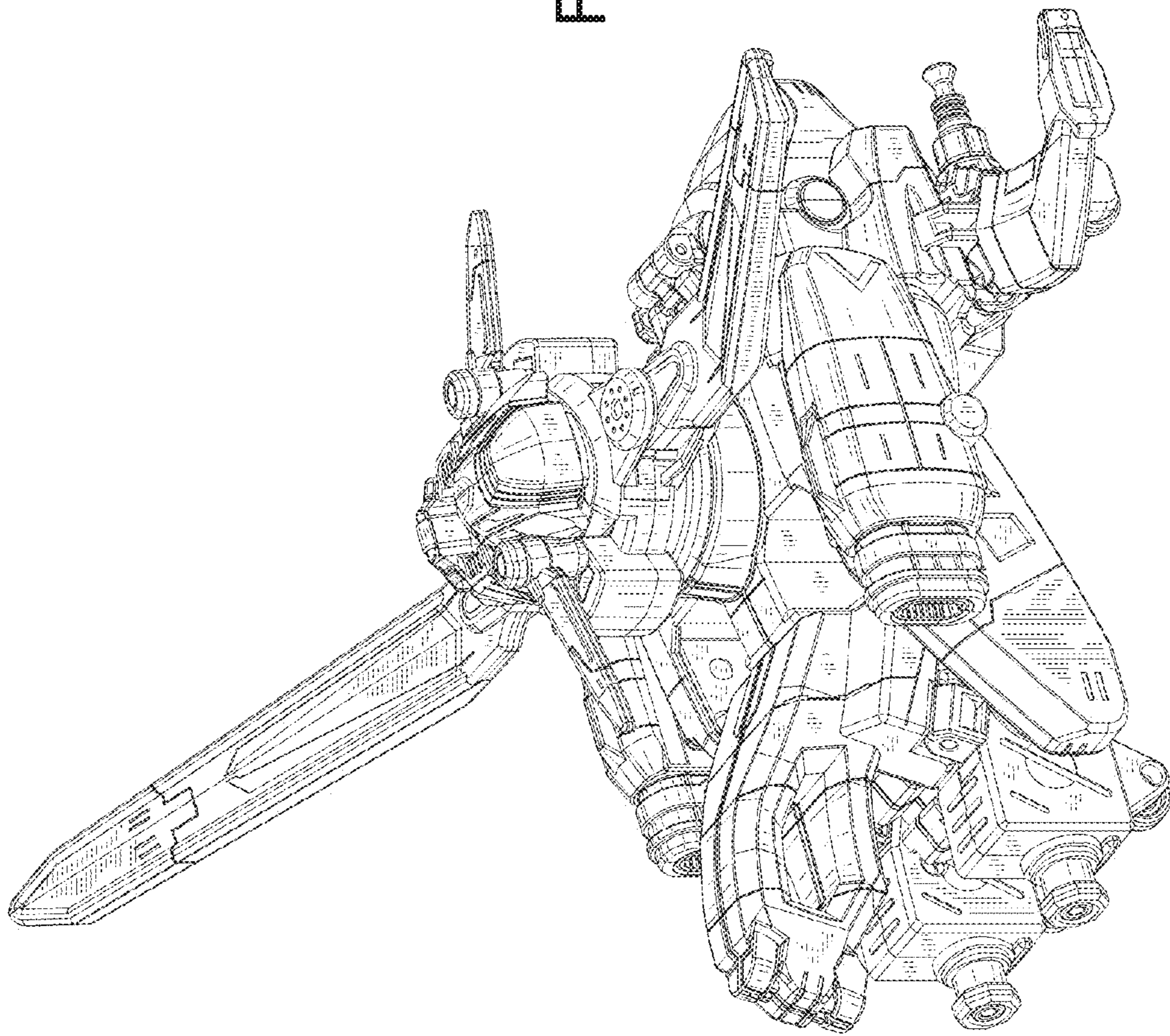

FIG. 15

FIG. 16



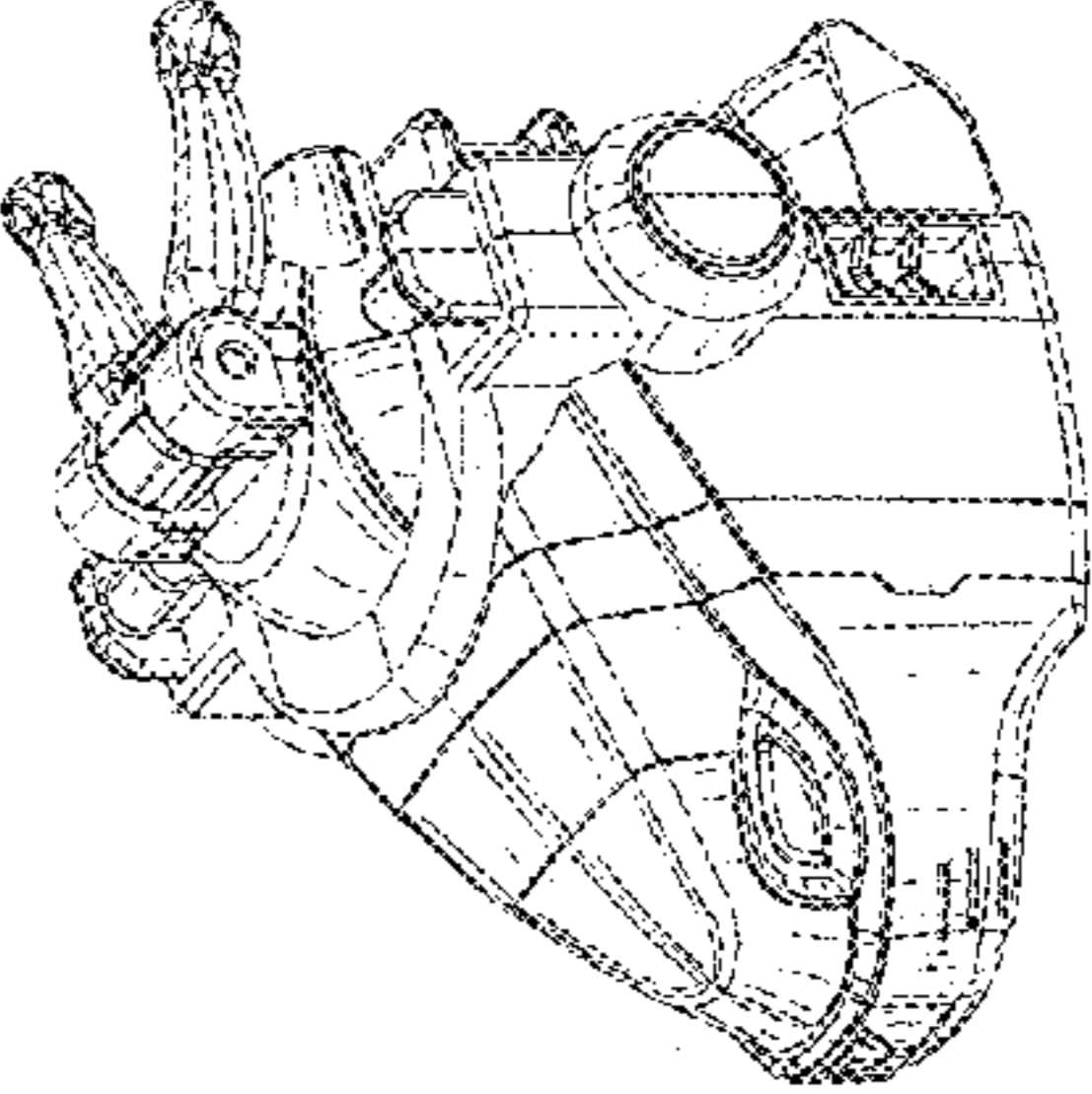
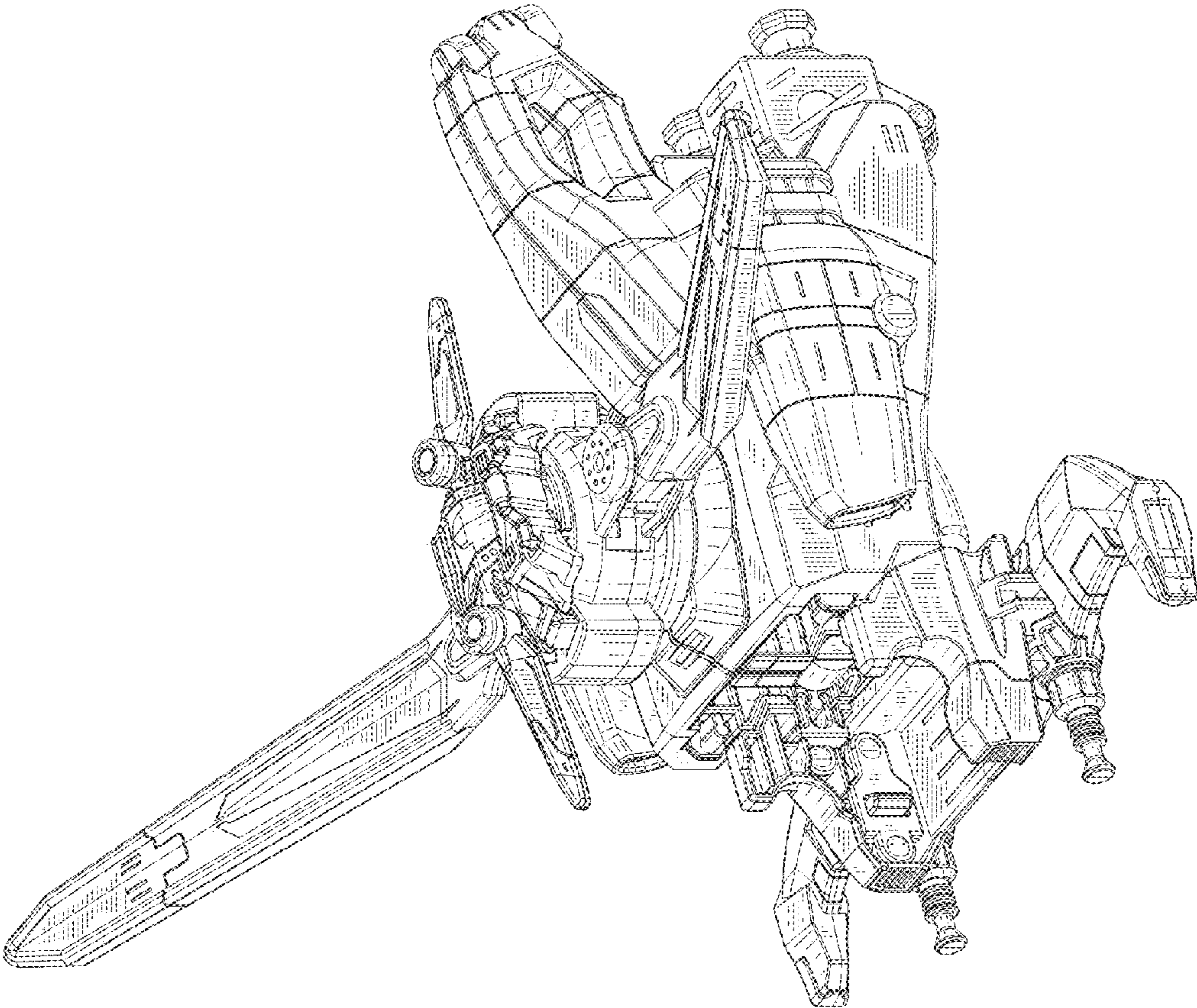

FIG. 17

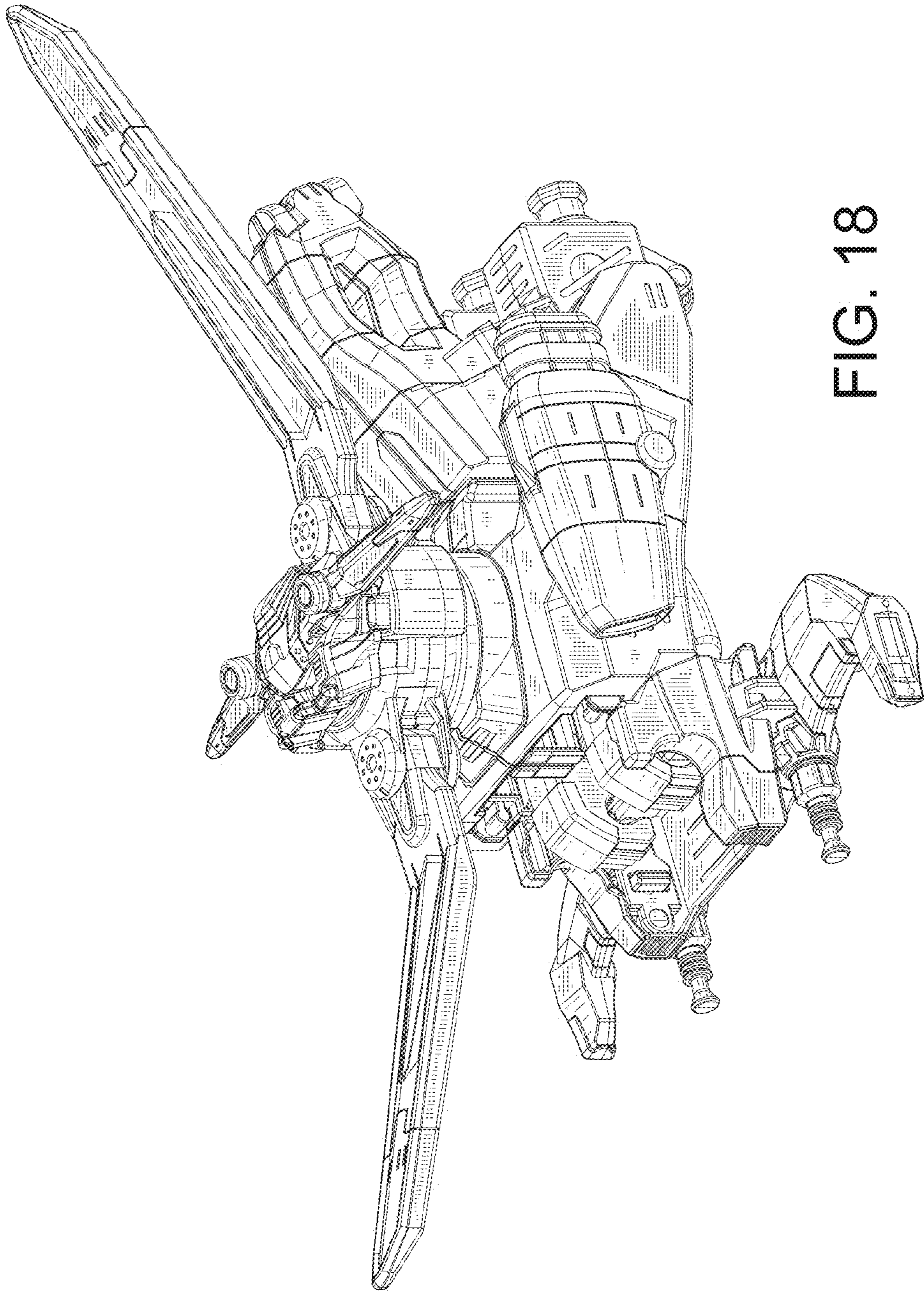

FIG. 18