



US00D687490S

(12) **United States Design Patent**
Mullen et al.

(10) **Patent No.:** **US D687,490 S**

(45) **Date of Patent:** **** *Aug. 6, 2013**

(54) **INTERACTIVE ELECTRONIC CARD WITH DISPLAY AND BUTTON**

(75) Inventors: **Jeffrey D. Mullen**, Pittsburgh, PA (US);
Eric R. Nicklaus, Pittsburgh, PA (US)

(73) Assignee: **Dynamics Inc.**, Pittsburgh, PA (US)

(*) Notice: This patent is subject to a terminal disclaimer.

(**) Term: **14 Years**

(21) Appl. No.: **29/430,530**

(22) Filed: **Aug. 27, 2012**

(51) **LOC (9) Cl.** **19-08**

(52) **U.S. Cl.**
USPC **D19/10**

(58) **Field of Classification Search**
USPC D19/1-12, 20-34; 40/124.01-124.15,
40/661, 672, 776, 726; 283/72, 74-75, 103,
283/105-107, 82, 70, 904; D21/385;
D20/10-11, 22, 27, 40, 42; D14/435-437;
360/2; 235/380, 382

See application file for complete search history.

(56) **References Cited**

U.S. PATENT DOCUMENTS

| | | |
|-------------|---------|---------------------|
| 4,353,064 A | 10/1982 | Stamm |
| 4,394,654 A | 7/1983 | Hofmann-Cerfontaine |
| 4,614,861 A | 9/1986 | Pavlov et al. |
| 4,667,087 A | 5/1987 | Quintana |
| 4,701,601 A | 10/1987 | Francini et al. |
| 4,720,860 A | 1/1988 | Weiss |
| 4,786,791 A | 11/1988 | Hodama |
| 4,791,283 A | 12/1988 | Burkhardt |
| 4,797,542 A | 1/1989 | Hara |
| 5,038,251 A | 8/1991 | Sugiyama et al. |
| 5,168,520 A | 12/1992 | Weiss |
| 5,237,614 A | 8/1993 | Weiss |

| | | |
|-------------|---------|--------------------|
| 5,276,311 A | 1/1994 | Hennige |
| 5,347,580 A | 9/1994 | Molva et al. |
| 5,361,062 A | 11/1994 | Weiss et al. |
| 5,412,199 A | 5/1995 | Finkelstein et al. |
| 5,434,398 A | 7/1995 | Goldberg |

(Continued)

FOREIGN PATENT DOCUMENTS

| | | |
|----|------------|---------|
| JP | 05210770 A | 8/1993 |
| WO | WO9852735 | 11/1998 |

(Continued)

OTHER PUBLICATIONS

U.S. Appl. No. 60/594,300, Poidomani et al.

(Continued)

Primary Examiner — Ian Simmons
Assistant Examiner — Abraham Bahta

(57) **CLAIM**

The ornamental design for an interactive electronic card with display and button, as shown and described.

DESCRIPTION

FIG. 1 is a back, bottom, and left side perspective view of our new design for an interactive electronic card with display and button;

FIG. 2 is a back, top, and left side perspective view thereof;

FIG. 3 is a front side view thereof;

FIG. 4 is a back side view thereof;

FIG. 5 is a top side view thereof;

FIG. 6 is a bottom side view thereof;

FIG. 7 is a left side view thereof; and,

FIG. 8 is a right side view thereof.

The broken lines showing environment in the drawings are for illustrative purposes only and form no part of the claimed design.

1 Claim, 5 Drawing Sheets

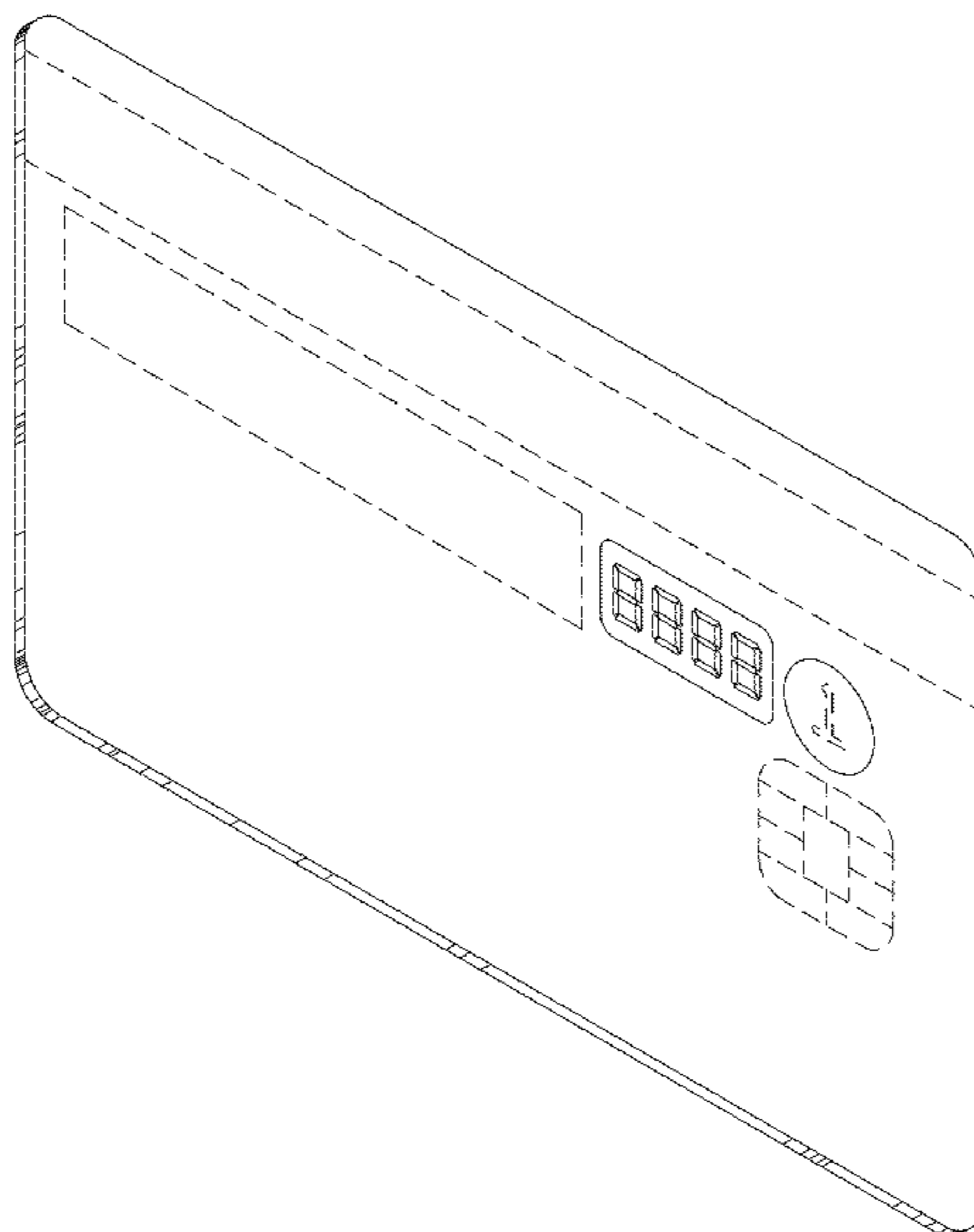

US D687,490 S

| U.S. PATENT DOCUMENTS | | | | | | | |
|-----------------------|----|---------|---------------------|--------------|-----|---------|---------------------------|
| 5,434,405 | A | 7/1995 | Finkelstein et al. | 7,195,154 | B2 | 3/2007 | Routhenstein |
| 5,478,994 | A | 12/1995 | Rahman | 7,197,639 | B1 | 3/2007 | Juels et al. |
| 5,479,512 | A | 12/1995 | Weiss | 7,219,368 | B2 | 5/2007 | Juels et al. |
| 5,484,997 | A | 1/1996 | Haynes | 7,225,537 | B2 | 6/2007 | Reed |
| 5,485,519 | A | 1/1996 | Weiss | 7,225,994 | B2 | 6/2007 | Finkelstein |
| 5,585,787 | A | 12/1996 | Wallerstein | 7,246,752 | B2 | 7/2007 | Brown |
| 5,591,949 | A | 1/1997 | Bernstein | 7,298,243 | B2 | 11/2007 | Juels et al. |
| 5,608,203 | A | 3/1997 | Finkelstein et al. | 7,334,732 | B2 | 2/2008 | Cooper |
| 5,623,552 | A | 4/1997 | Lane | 7,337,326 | B2 | 2/2008 | Palmer et al. |
| 5,657,388 | A | 8/1997 | Weiss | 7,346,775 | B2 | 3/2008 | Gasparini et al. |
| 5,834,747 | A | 11/1998 | Cooper | 7,356,696 | B1 | 4/2008 | Jakobsson et al. |
| 5,834,756 | A | 11/1998 | Gutman et al. | 7,357,319 | B1 | 4/2008 | Lin et al. |
| 5,856,661 | A | 1/1999 | Finkelstein et al. | 7,359,507 | B2 | 4/2008 | Kaliski |
| 5,864,623 | A | 1/1999 | Messina et al. | 7,360,688 | B1 | 4/2008 | Harris |
| 5,907,142 | A | 5/1999 | Kelsey | 7,363,494 | B2 | 4/2008 | Brainard et al. |
| 5,913,203 | A | 6/1999 | Wong et al. | 7,380,710 | B2 | 6/2008 | Brown |
| 5,937,394 | A | 8/1999 | Wong et al. | 7,398,253 | B1 | 7/2008 | Pinnell |
| 5,955,021 | A | 9/1999 | Tiffany, III | 7,404,087 | B2 | 7/2008 | Teunen |
| 5,956,699 | A | 9/1999 | Wong et al. | 7,424,570 | B2 | 9/2008 | D'Albore et al. |
| 6,025,054 | A | 2/2000 | Tiffany, III | 7,427,033 | B1 | 9/2008 | Roskind |
| 6,045,043 | A | 4/2000 | Bashan et al. | 7,454,349 | B2 | 11/2008 | Teunen et al. |
| 6,076,163 | A | 6/2000 | Hoffstein et al. | 7,461,250 | B1 | 12/2008 | Duane et al. |
| 6,085,320 | A | 7/2000 | Kaliski | 7,461,399 | B2 | 12/2008 | Juels et al. |
| 6,095,416 | A | 8/2000 | Grant et al. | 7,472,093 | B2 | 12/2008 | Juels |
| 6,130,621 | A | 10/2000 | Weiss | 7,472,829 | B2 | 1/2009 | Brown |
| 6,145,079 | A | 11/2000 | Mitty et al. | 7,494,055 | B2 | 2/2009 | Fernandes et al. |
| 6,157,920 | A | 12/2000 | Jakobsson et al. | 7,502,467 | B2 | 3/2009 | Brainard et al. |
| 6,161,181 | A | 12/2000 | Haynes, III et al. | 7,502,933 | B2 | 3/2009 | Jakobsson et al. |
| 6,176,430 | B1 | 1/2001 | Finkelstein et al. | 7,503,485 | B1 | 3/2009 | Routhenstein |
| 6,182,894 | B1 | 2/2001 | Hackett et al. | 7,516,492 | B1 | 4/2009 | Nisbet et al. |
| 6,189,098 | B1 | 2/2001 | Kaliski | 7,523,301 | B2 | 4/2009 | Nisbet et al. |
| 6,199,052 | B1 | 3/2001 | Mitty et al. | 7,530,495 | B2 | 5/2009 | Cooper |
| 6,206,293 | B1 | 3/2001 | Gutman et al. | 7,532,104 | B2 | 5/2009 | Juels |
| 6,240,184 | B1 | 5/2001 | Huynh et al. | 7,543,739 | B2 | 6/2009 | Brown et al. |
| 6,241,153 | B1 | 6/2001 | Tiffany, III | 7,559,464 | B2 | 7/2009 | Routhenstein |
| 6,256,873 | B1 | 7/2001 | Tiffany, III | 7,562,221 | B2 | 7/2009 | Nystrom et al. |
| 6,269,163 | B1 | 7/2001 | Rivest et al. | 7,562,222 | B2 | 7/2009 | Gasparini et al. |
| 6,286,022 | B1 | 9/2001 | Kaliski et al. | 7,580,898 | B2 | 8/2009 | Brown et al. |
| 6,308,890 | B1 | 10/2001 | Cooper | 7,584,153 | B2 | 9/2009 | Brown et al. |
| 6,313,724 | B1 | 11/2001 | Osterweil | 7,591,426 | B2 | 9/2009 | Osterweil et al. |
| 6,389,442 | B1 | 5/2002 | Yin et al. | 7,591,427 | B2 | 9/2009 | Osterweil |
| 6,393,447 | B1 | 5/2002 | Jakobsson et al. | 7,602,904 | B2 | 10/2009 | Juels et al. |
| 6,411,715 | B1 | 6/2002 | Liskov et al. | 7,631,804 | B2 | 12/2009 | Brown |
| 6,446,052 | B1 | 9/2002 | Juels | 7,639,537 | B2 | 12/2009 | Sepe et al. |
| 6,460,141 | B1 | 10/2002 | Olden | 7,641,124 | B2 | 1/2010 | Brown et al. |
| 6,592,044 | B1 | 7/2003 | Wong et al. | 7,660,902 | B2 | 2/2010 | Graham et al. |
| 6,607,127 | B2 | 8/2003 | Wong | 7,828,207 | B2 | 11/2010 | Cooper |
| 6,609,654 | B1 | 8/2003 | Anderson et al. | D651,237 | S * | 12/2011 | Mullen et al. D19/10 |
| 6,631,849 | B2 | 10/2003 | Blossom | D652,075 | S * | 1/2012 | Mullen et al. D19/10 |
| 6,655,585 | B2 | 12/2003 | Shinn | D652,076 | S * | 1/2012 | Mullen et al. D19/10 |
| 6,681,988 | B2 | 1/2004 | Stack et al. | D652,448 | S * | 1/2012 | Mullen et al. D19/10 |
| 6,705,520 | B1 | 3/2004 | Pitroda et al. | D653,288 | S * | 1/2012 | Mullen et al. D19/10 |
| 6,755,341 | B1 | 6/2004 | Wong et al. | D670,331 | S * | 11/2012 | Mullen et al. D19/9 |
| 6,764,005 | B2 | 7/2004 | Cooper | D670,759 | S * | 11/2012 | Mullen et al. D19/9 |
| 6,769,618 | B1 | 8/2004 | Finkelstein | 2001/0034702 | A1 | 10/2001 | Mockett et al. |
| 6,805,288 | B2 | 10/2004 | Routhenstein et al. | 2001/0047335 | A1 | 11/2001 | Arndt et al. |
| 6,811,082 | B2 | 11/2004 | Wong | 2002/0059114 | A1 | 5/2002 | Cockrill et al. |
| 6,813,354 | B1 | 11/2004 | Jakobsson et al. | 2002/0082989 | A1 | 6/2002 | Fife et al. |
| 6,817,532 | B2 | 11/2004 | Finkelstein | 2002/0096570 | A1 | 7/2002 | Wong et al. |
| 6,873,974 | B1 | 3/2005 | Schutzler | 2002/0120583 | A1 | 8/2002 | Keresman, III et al. |
| 6,902,116 | B2 | 6/2005 | Finkelstein | 2003/0034388 | A1 | 2/2003 | Routhenstein et al. |
| 6,970,070 | B2 | 11/2005 | Juels et al. | 2003/0052168 | A1 | 3/2003 | Wong |
| 6,980,969 | B1 | 12/2005 | Tuchler et al. | 2003/0057278 | A1 | 3/2003 | Wong |
| 6,985,583 | B1 | 1/2006 | Brainard et al. | 2003/0116635 | A1 | 6/2003 | Taban |
| 6,991,155 | B2 | 1/2006 | Burchette, Jr. | 2003/0152253 | A1 | 8/2003 | Wong |
| 7,013,030 | B2 | 3/2006 | Wong et al. | 2003/0163287 | A1 | 8/2003 | Vock et al. |
| 7,035,443 | B2 | 4/2006 | Wong | 2003/0173409 | A1 | 9/2003 | Vogt et al. |
| 7,039,223 | B2 | 5/2006 | Wong | 2003/0179909 | A1 | 9/2003 | Wong et al. |
| 7,044,394 | B2 | 5/2006 | Brown | 2003/0179910 | A1 | 9/2003 | Wong |
| 7,051,929 | B2 | 5/2006 | Li | 2003/0226899 | A1 | 12/2003 | Finkelstein |
| 7,083,094 | B2 | 8/2006 | Cooper | 2004/0035942 | A1 | 2/2004 | Silverman |
| 7,100,049 | B2 | 8/2006 | Gasparini et al. | 2004/0133787 | A1 | 7/2004 | Doughty |
| 7,100,821 | B2 | 9/2006 | Rasti | 2004/0162732 | A1 | 8/2004 | Rahim et al. |
| 7,111,172 | B1 | 9/2006 | Duane et al. | 2004/0172535 | A1 | 9/2004 | Jakobsson |
| 7,114,652 | B2 | 10/2006 | Moulllette et al. | 2004/0177045 | A1 | 9/2004 | Brown |
| 7,136,514 | B1 | 11/2006 | Wong | 2005/0043997 | A1 | 2/2005 | Sohata et al. |
| 7,140,550 | B2 | 11/2006 | Ramachandran | 2005/0080747 | A1 | 4/2005 | Anderson et al. |
| 7,163,153 | B2 | 1/2007 | Blossom | 2005/0086160 | A1 | 4/2005 | Wong et al. |
| | | | | 2005/0086177 | A1 | 4/2005 | Anderson et al. |

US D687,490 S

Page 3

| | | | | | |
|-----------------|---------|----------------------|-----------------|---------|------------------|
| 2005/0116026 A1 | 6/2005 | Burger et al. | 2008/0148394 A1 | 6/2008 | Poidomani et al. |
| 2005/0119940 A1 | 6/2005 | Concilio et al. | 2008/0201264 A1 | 8/2008 | Brown et al. |
| 2005/0154643 A1 | 7/2005 | Doan et al. | 2008/0209550 A1 | 8/2008 | Di Iorio |
| 2005/0228959 A1 | 10/2005 | D'Albore et al. | 2008/0288699 A1 | 11/2008 | Chichierchia |
| 2006/0000900 A1 | 1/2006 | Fernandes et al. | 2008/0294930 A1 | 11/2008 | Varone et al. |
| 2006/0037073 A1 | 2/2006 | Juels et al. | 2008/0302877 A1 | 12/2008 | Musella et al. |
| 2006/0041759 A1 | 2/2006 | Kaliski et al. | 2009/0013122 A1 | 1/2009 | Sepe et al. |
| 2006/0085328 A1 | 4/2006 | Cohen et al. | 2009/0036147 A1 | 2/2009 | Romano |
| 2006/0091223 A1 | 5/2006 | Zellner | 2009/0046522 A1 | 2/2009 | Sepe et al. |
| 2006/0161435 A1 | 7/2006 | Atef et al. | 2009/0108064 A1 | 4/2009 | Fernandes et al. |
| 2006/0163353 A1 | 7/2006 | Moulette et al. | 2009/0150295 A1 | 6/2009 | Hatch et al. |
| 2006/0174104 A1 | 8/2006 | Crichton et al. | 2009/0152365 A1 | 6/2009 | Li et al. |
| 2006/0196931 A1 | 9/2006 | Holtmanns et al. | 2009/0242648 A1 | 10/2009 | Di Sirio et al. |
| 2006/0256961 A1 | 11/2006 | Brainard et al. | 2009/0244858 A1 | 10/2009 | Di Sirio et al. |
| 2007/0034700 A1 | 2/2007 | Poidomani et al. | 2009/0253460 A1 | 10/2009 | Varone et al. |
| 2007/0114274 A1 | 5/2007 | Gibbs et al. | 2009/0255996 A1 | 10/2009 | Brown et al. |
| 2007/0124321 A1 | 5/2007 | Szydlo | 2009/0290704 A1 | 11/2009 | Cimino |
| 2007/0152070 A1 | 7/2007 | D'Albore | 2009/0303885 A1 | 12/2009 | Longo |
| 2007/0152072 A1 | 7/2007 | Frallicciardi et al. | 2011/0028184 A1 | 2/2011 | Cooper |
| 2007/0153487 A1 | 7/2007 | Frallicciardi et al. | | | |
| 2007/0174614 A1 | 7/2007 | Duane et al. | | | |
| 2007/0192249 A1 | 8/2007 | Biffle et al. | | | |
| 2007/0241183 A1 | 10/2007 | Brown et al. | | | |
| 2007/0241201 A1 | 10/2007 | Brown et al. | | | |
| 2007/0256123 A1 | 11/2007 | Duane et al. | | | |
| 2007/0291753 A1 | 12/2007 | Romano | | | |
| 2008/0005510 A1 | 1/2008 | Sepe et al. | | | |
| 2008/0008315 A1 | 1/2008 | Fontana et al. | | | |
| 2008/0008322 A1 | 1/2008 | Fontana et al. | | | |
| 2008/0010675 A1 | 1/2008 | Massascusa et al. | | | |
| 2008/0016351 A1 | 1/2008 | Fontana et al. | | | |
| 2008/0019507 A1 | 1/2008 | Fontana et al. | | | |
| 2008/0028447 A1 | 1/2008 | O'Malley et al. | | | |
| 2008/0040271 A1 | 2/2008 | Hammad et al. | | | |
| 2008/0040276 A1 | 2/2008 | Hammad et al. | | | |
| 2008/0058016 A1 | 3/2008 | Di Maggio et al. | | | |
| 2008/0059379 A1 | 3/2008 | Ramaci et al. | | | |
| 2008/0096326 A1 | 4/2008 | Reed | | | |
| 2008/0126398 A1 | 5/2008 | Cimino | | | |
| 2008/0128515 A1 | 6/2008 | Di Iorio | | | |

FOREIGN PATENT DOCUMENTS

| | | |
|----|--------------|---------|
| WO | WO0247019 | 6/2002 |
| WO | WO2006066322 | 6/2006 |
| WO | WO2006080929 | 8/2006 |
| WO | WO2006105092 | 10/2006 |
| WO | WO2006116772 | 11/2006 |
| WO | WO2008064403 | 6/2008 |

OTHER PUBLICATIONS

U.S. Appl. No. 60/675,388, Poidomani et al.
The Bank Credit Card Business. Second Edition, American Bankers Association, Washington, D.C., 1996.
A Day in the Life of a Flux Reversal. <http://www.phrack.org/issues.html?issue=37&id=6#article>. As viewed on Apr. 12, 2010.
Dynamic Virtual Credit Card Numbers. <http://homes.cerias.purdue.edu/~jtl/paper/fc07.pdf>. As viewed on Apr. 12, 2010.
English translation of JP 05210770 A.

* cited by examiner

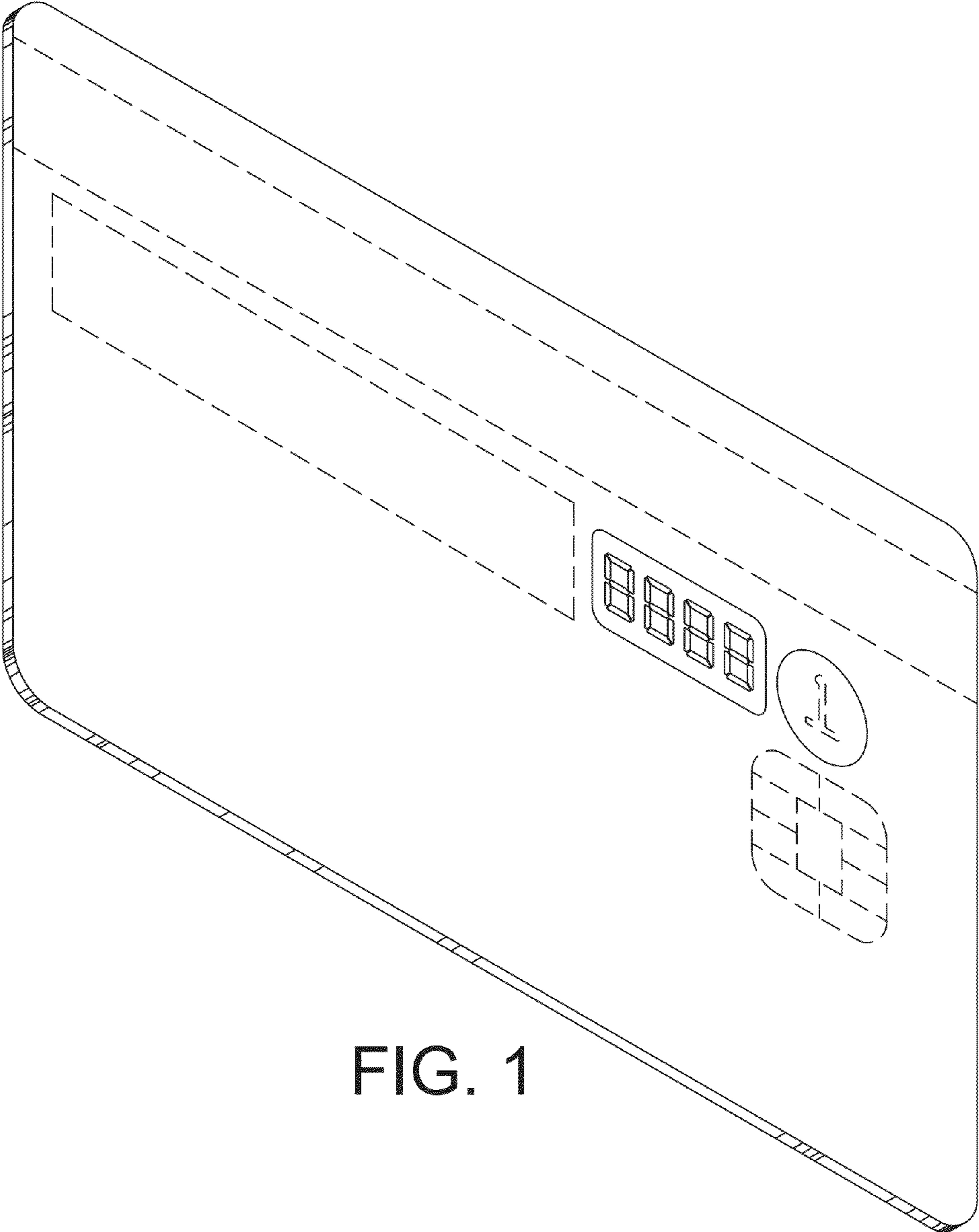

FIG. 1

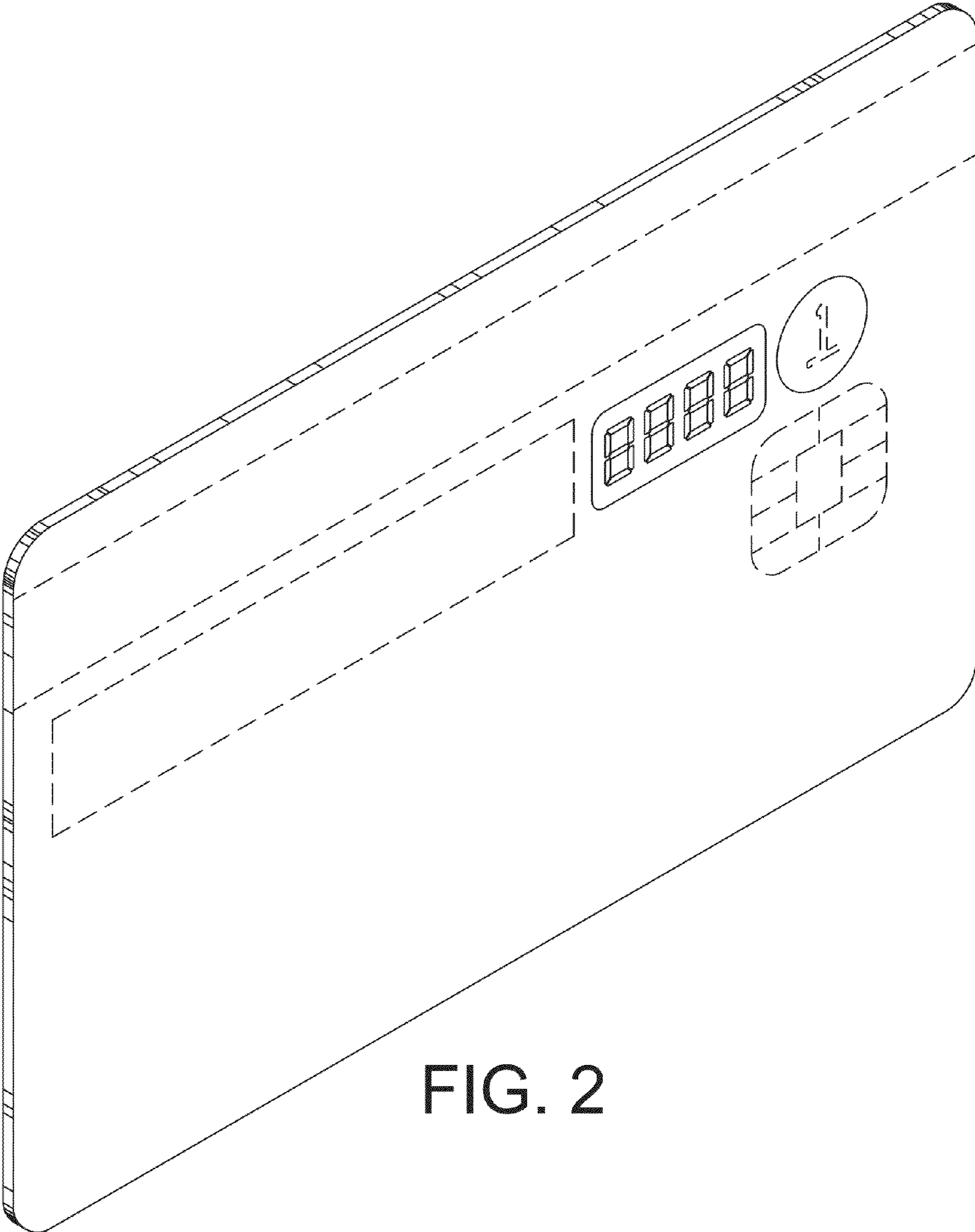

FIG. 2

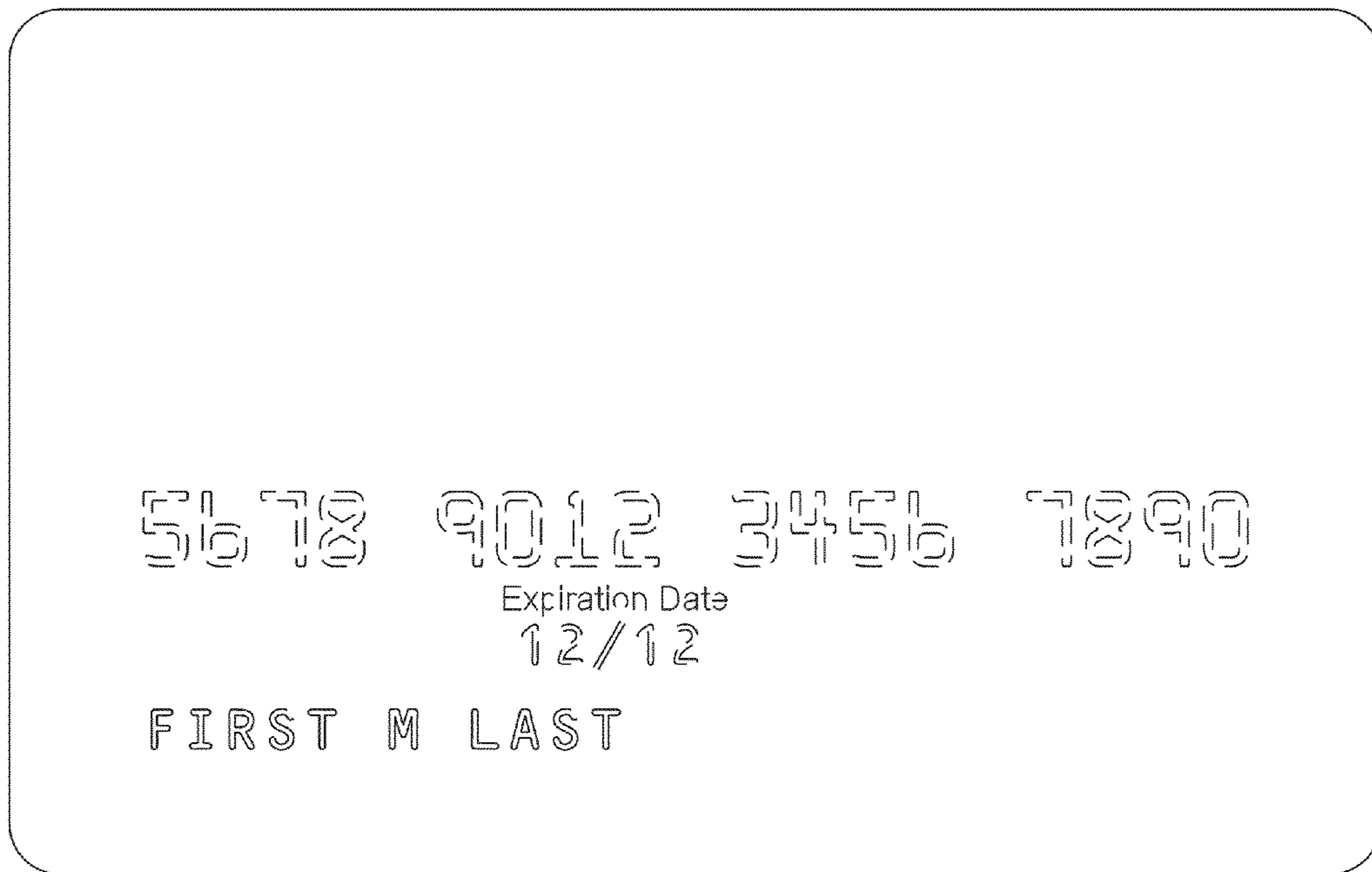

FIG. 3

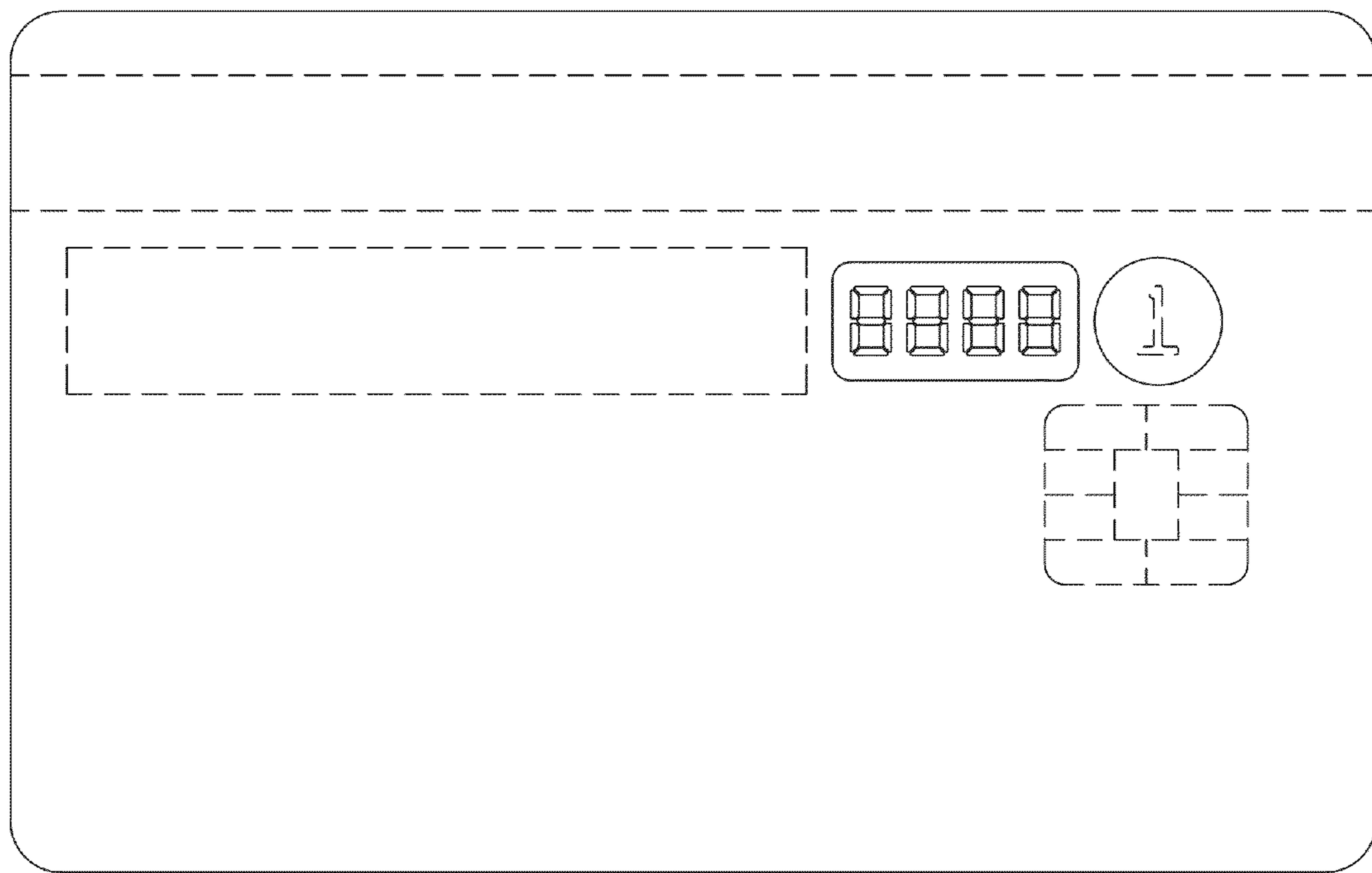

FIG. 4

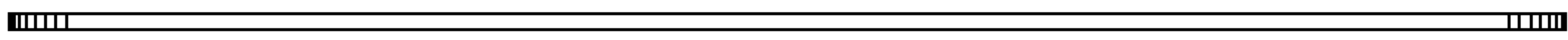

FIG. 5

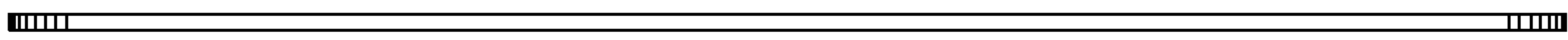

FIG. 6

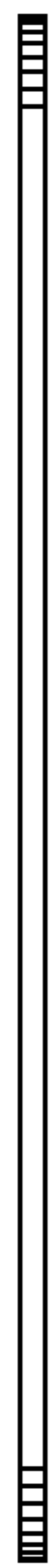

FIG. 7



FIG. 8